

# RCI 910TC







## Touchless Switches



The RCI 910TC touchless switch is designed for touchless door activation in any facility. It functions by triggering activation of automatic door openers by hand gesture or use of a remote fob. It can make the difference when it comes to a clean, hygienic facility. The 910TC is ideal for use in healthcare facilities, restaurants, schools, offices and restrooms by minimizing touchpoints.

### Features

- Unique low-profile touchless actuator plate utilizing capacitive technology for the activation of automatic doors
- Aesthetically pleasing design
- Hands-free – helps reduce the spread of germs and bacteria
- Adjustable detection zone to reduce unwanted activations
- When device is activated, the indicator light will change color
- Option to disable audible indicator
- Secondary Normally Open (NO) mechanical switch in the event of a power loss
- Selectable unlock times (1-63 seconds)
- Available in narrow (mullion) or standard size
- Standard mounts to single-gang electrical box
- Available remote control to trigger switch remotely
- Available in kit options
- Also available with french language plates
- Option to toggle momentary to maintained
- FCC & ISED Certified
- Meets ADA compliance (check local building codes for compliance)

 Energy 12-24VDC 50/25mA	 Range 1" to 2" (30mm - 50mm)	 Warranty 2 Year Limited Warranty
 Switch Mode Momentary	 Switch Configuration SPDT	 FCC & ISED Certified

### Accessories

- 910TC-WRM - 433MHz Remote Receiver Module
- 910TC-WRB - 433MHz Remote Transmitter



910TC-WRM  
433MHz Remote  
Receiver Module



910TC-WRB  
433MHz Remote  
Transmitter

## Dimensions - Standard & Narrow (mullion)

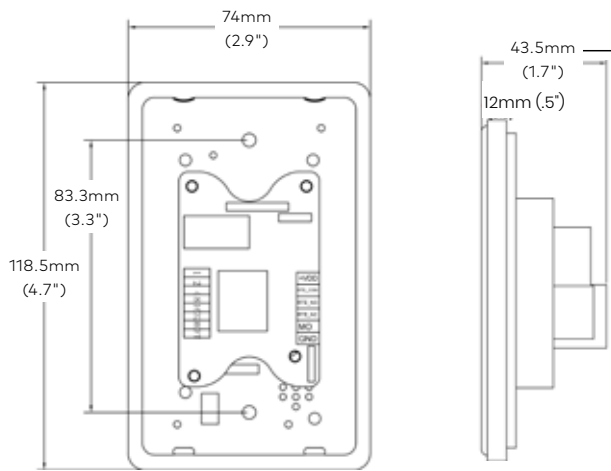

## Specifications

<b>Technology Type</b>	Capacitive sensing Capacitive sensing with infrared technology
<b>Detection Mode</b>	Proximity
<b>Detection Zone</b>	Maximum detection zone of up to 2" (50mm)
<b>Current</b>	50mA (typical)/ 115mA (activated) 115mA (narrow)
<b>Voltage</b>	12-24VDC
<b>Temperature Range</b>	-4° F to 140° F (-20°C to +60°C)
<b>Relay</b>	Form C SPDT 24VDC @ 100mA
<b>Certification &amp; Listings</b>	FCC & ISED certified ADA compliant

© dormakaba 2021 Information on this sheet is intended for general use only. dormakaba reserves the right to alter designs and specifications without notice or obligation.

dormakaba USA Inc.  
6161 E. 75th St.  
Indianapolis, IN 46250  
800.523.8483

dormakaba Canada Inc.  
65 Struck Court  
Cambridge, ON N1R 8L2  
800.387.4938