

April 1, 2019

To: Our Valued Customers

Re: ASSA ABLOY Architectural Hardware Group Pricing Adjustments

ASSA ABLOY Architectural Hardware Group is announcing an average price adjustment of 3.5% effective June 3, 2019. Price adjustments include Architectural Door Accessories and the brands of Corbin Russwin, Norton, RIXSON, SARGENT and Yale Commercial. Exact % adjustments will vary by brand or product series and some product lines will remain the same.

By May 1, 2019, updated price books will be available electronically on brand website libraries for easy searchability, download and printing.

To reduce waste in support of our sustainability goals, printed price books will only be available to customers who register to receive a printed copy.

If you are **new** to the price book order portal, please use this link to register for an ID and password: <http://www.nacorporation.com/registration/pricebooks>

User IDs and passwords will be issued to new registrants every Monday. You will also receive instructions on how to login and reserve your printed copies of the price book.

If you are an **existing** user, please use this link to login to reserve your price books: <https://www.nacorporation.com/smart2011/assa-login.aspx>

Price books will ship on a first-come, first-served basis in the order requests are received.

For assistance, please call 1-800-508-5426. A representative of NVISION, our print and order fulfillment company, will be happy to help you through the registration/order process.

Thank you for your continued support and partnership.

Sincerely,



Bill Grambo
President, Access and Egress Hardware



Doug Thompson
President, Architectural Door Accessories

Checklist

Your price book should contain the following dated pages. If any pages are missing, return this list with the missing items circled and we will forward them to you.

GENERAL INFORMATION

GI-1 June 3, 2019
GI-2 June 3, 2019
GI-3 June 3, 2019
GI-4 June 3, 2019
GI-5 June 3, 2019
GI-6 June 3, 2019
GI-7 June 3, 2019
GI-8 June 3, 2019
GI-9 June 3, 2019
GI-10 June 3, 2019
GI-11 June 3, 2019
GI-12 June 3, 2019
GI-13 June 3, 2019
GI-14 June 3, 2019
GI-15 June 3, 2019
GI-16 June 3, 2019
GI-17 June 3, 2019
GI-18 June 3, 2019
GI-19 June 3, 2019
GI-20 June 3, 2019
GI-21 June 3, 2019
GI-22 June 3, 2019
GI-23 June 3, 2019
GI-24 June 3, 2019
GI-25 June 3, 2019
GI-26 June 3, 2019
GI-27 June 3, 2019
GI-28 June 3, 2019
GI-29 June 3, 2019
GI-30 June 3, 2019
GI-31 June 3, 2019
GI-32 June 3, 2019
GI-33 June 3, 2019
GI-34 June 3, 2019
GI-35 June 3, 2019
GI-36 June 3, 2019
GI-37 June 3, 2019
GI-38 June 3, 2019
GI-39 June 3, 2019
GI-40 June 3, 2019

CYLINDERS & KEYING

CK-1 June 3, 2019
CK-2 June 3, 2019
CK-3 June 3, 2019
CK-4 June 3, 2019
CK-5 June 3, 2019
CK-6 June 3, 2019
CK-7 June 3, 2019
CK-8 June 3, 2019
CK-9 June 3, 2019
CK-10 June 3, 2019
CK-11 June 3, 2019

CK-12 June 3, 2019
CK-13 June 3, 2019
CK-14 June 3, 2019
CK-15 June 3, 2019
CK-16 June 3, 2019
CK-17 June 3, 2019
CK-18 June 3, 2019

CK-19 June 3, 2019
CK-20 June 3, 2019
CK-21 June 3, 2019
CK-22 June 3, 2019
CK-23 June 3, 2019
CK-24 June 3, 2019
CK-25 June 3, 2019
CK-26 June 3, 2019
CK-27 June 3, 2019
CK-28 June 3, 2019
CK-29 June 3, 2019
CK-30 June 3, 2019
CK-31 June 3, 2019
CK-32 June 3, 2019
CK-33 June 3, 2019
CK-34 June 3, 2019
CK-35 June 3, 2019
CK-36 June 3, 2019
CK-37 June 3, 2019
CK-38 June 3, 2019

BORED LOCKS

BL-1 June 3, 2019
BL-2 June 3, 2019
BL-3 June 3, 2019
BL-4 June 3, 2019
BL-5 June 3, 2019
BL-6 June 3, 2019
BL-7 June 3, 2019
BL-8 June 3, 2019
BL-9 June 3, 2019
BL-10 June 3, 2019
BL-11 June 3, 2019
BL-12 June 3, 2019
BL-13 June 3, 2019
BL-14 June 3, 2019
BL-15 June 3, 2019
BL-16 June 3, 2019
BL-17 June 3, 2019
BL-18 June 3, 2019
BL-19 June 3, 2019
BL-20 June 3, 2019
BL-21 June 3, 2019
BL-22 June 3, 2019
BL-23 June 3, 2019
BL-24 June 3, 2019

BL-25 June 3, 2019
BL-26 June 3, 2019
BL-27 June 3, 2019
BL-28 June 3, 2019
BL-29 June 3, 2019
BL-30 June 3, 2019
BL-31 June 3, 2019
BL-32 June 3, 2019
BL-33 June 3, 2019
BL-34 June 3, 2019
BL-35 June 3, 2019
BL-36 June 3, 2019
BL-37 June 3, 2019
BL-38 June 3, 2019
BL-39 June 3, 2019
BL-40 June 3, 2019
BL-41 June 3, 2019
BL-42 June 3, 2019
BL-43 June 3, 2019
BL-44 June 3, 2019
BL-45 June 3, 2019
BL-46 June 3, 2019
BL-47 June 3, 2019
BL-48 June 3, 2019
BL-49 June 3, 2019
BL-50 June 3, 2019
BL-51 June 3, 2019

MORTISE LOCKS

ML-1 June 3, 2019
ML-2 June 3, 2019
ML-3 June 3, 2019
ML-4 June 3, 2019
ML-5 June 3, 2019
ML-6 June 3, 2019
ML-7 June 3, 2019
ML-8 June 3, 2019
ML-9 June 3, 2019
ML-10 June 3, 2019
ML-11 June 3, 2019
ML-12 June 3, 2019
ML-13 June 3, 2019
ML-14 June 3, 2019
ML-15 June 3, 2019
ML-16 June 3, 2019
ML-17 June 3, 2019
ML-18 June 3, 2019
ML-19 June 3, 2019
ML-20 June 3, 2019
ML-21 June 3, 2019
ML-22 June 3, 2019
ML-23 June 3, 2019
ML-24 June 3, 2019
ML-25 June 3, 2019

ML-26 June 3, 2019
ML-27 June 3, 2019
ML-28 June 3, 2019
ML-29 June 3, 2019
ML-30 June 3, 2019
ML-31 June 3, 2019
ML-32 June 3, 2019
ML-33 June 3, 2019
ML-34 June 3, 2019
ML-35 June 3, 2019
ML-36 June 3, 2019
ML-37 June 3, 2019
ML-38 June 3, 2019
ML-39 June 3, 2019
ML-40 June 3, 2019
ML-41 June 3, 2019
ML-42 June 3, 2019
ML-43 June 3, 2019
ML-44 June 3, 2019
ML-45 June 3, 2019
ML-46 June 3, 2019
ML-47 June 3, 2019
ML-48 June 3, 2019
ML-49 June 3, 2019
ML-50 June 3, 2019
ML-51 June 3, 2019
ML-52 June 3, 2019
ML-53 June 3, 2019
ML-54 June 3, 2019
ML-55 June 3, 2019
ML-56 June 3, 2019
ML-57 June 3, 2019
ML-58 June 3, 2019
ML-59 June 3, 2019
ML-60 June 3, 2019
ML-61 June 3, 2019
ML-62 June 3, 2019
ML-63 June 3, 2019
ML-64 June 3, 2019
ML-65 June 3, 2019
ML-66 June 3, 2019
ML-67 June 3, 2019
ML-68 June 3, 2019
ML-69 June 3, 2019
ML-70 June 3, 2019
ML-71 June 3, 2019
ML-72 June 3, 2019
ML-73 June 3, 2019
ML-74 June 3, 2019
ML-75 June 3, 2019
ML-76 June 3, 2019
ML-77 June 3, 2019
ML-78 June 3, 2019
ML-79 June 3, 2019

ML-80 June 3, 2019
ML-81 June 3, 2019
ML-82 June 3, 2019
ML-83 June 3, 2019
ML-84 June 3, 2019
ML-85 June 3, 2019
ML-86 June 3, 2019
ML-87 June 3, 2019
ML-88 June 3, 2019
ML-89 June 3, 2019
ML-90 June 3, 2019
ML-91 June 3, 2019
ML-92 June 3, 2019
ML-93 June 3, 2019
ML-94 June 3, 2019
ML-95 June 3, 2019
ML-96 June 3, 2019
ML-97 June 3, 2019
ML-98 June 3, 2019
ML-99 June 3, 2019
ML-100 June 3, 2019
ML-101 June 3, 2019
ML-102 June 3, 2019
ML-103 June 3, 2019
ML-104 June 3, 2019
ML-105 June 3, 2019
ML-106 June 3, 2019
ML-107 June 3, 2019
ML-108 June 3, 2019
ML-109 June 3, 2019
ML-110 June 3, 2019
ML-111 June 3, 2019
ML-112 June 3, 2019
ML-113 June 3, 2019
ML-114 June 3, 2019
ML-115 June 3, 2019
ML-116 June 3, 2019
ML-117 June 3, 2019
ML-118 June 3, 2019
ML-119 June 3, 2019
ML-120 June 3, 2019
ML-121 June 3, 2019
ML-122 June 3, 2019
ML-123 June 3, 2019
ML-124 June 3, 2019
ML-125 June 3, 2019
ML-126 June 3, 2019
ML-127 June 3, 2019
ML-128 June 3, 2019
ML-129 June 3, 2019
ML-130 June 3, 2019
ML-131 June 3, 2019
ML-132 June 3, 2019
ML-133 June 3, 2019

COMPANY NAME: _____

ADDRESS: _____

ATTN: _____

Checklist

Your price book should contain the following dated pages. If any pages are missing, return this list with the missing items circled and we will forward them to you.

ML-134 June 3, 2019
ML-135 June 3, 2019
ML-136 June 3, 2019
ML-137 June 3, 2019
ML-138 June 3, 2019
ML-139 June 3, 2019
ML-140 June 3, 2019
ML-141 June 3, 2019
ML-142 June 3, 2019
ML-143 June 3, 2019
ML-144 June 3, 2019
ML-145 June 3, 2019
ML-146 June 3, 2019
ML-147 June 3, 2019
ML-148 June 3, 2019
ML-149 June 3, 2019
ML-150 June 3, 2019
ML-151 June 3, 2019
ML-152 June 3, 2019
ML-153 June 3, 2019
ML-154 June 3, 2019
ML-155 June 3, 2019
ML-156 June 3, 2019
ML-157 June 3, 2019
ML-158 June 3, 2019
ML-159 June 3, 2019
ML-160 June 3, 2019
ML-161 June 3, 2019
ML-162 June 3, 2019
ML-163 June 3, 2019
ML-164 June 3, 2019
ML-165 June 3, 2019
ML-166 June 3, 2019
ML-167 June 3, 2019
ML-168 June 3, 2019
ML-169 June 3, 2019
ML-170 June 3, 2019
ML-171 June 3, 2019
ML-172 June 3, 2019
ML-173 June 3, 2019
ML-174 June 3, 2019
ML-175 June 3, 2019

MP-6 June 3, 2019
MP-7 June 3, 2019
MP-8 June 3, 2019
MP-9 June 3, 2019
MP-10 June 3, 2019
MP-11 June 3, 2019
MP-12 June 3, 2019
MP-13 June 3, 2019
MP-14 June 3, 2019
MP-15 June 3, 2019
MP-16 June 3, 2019
MP-17 June 3, 2019
MP-18 June 3, 2019
MP-19 June 3, 2019
MP-20 June 3, 2019
MP-21 June 3, 2019
MP-22 June 3, 2019
MP-23 June 3, 2019

DOOR CLOSERS/ HOLDERS & STOPS

DC-1 June 3, 2019
DC-2 June 3, 2019
DC-3 June 3, 2019
DC-4 June 3, 2019
DC-5 June 3, 2019
DC-6 June 3, 2019
DC-7 June 3, 2019
DC-8 June 3, 2019
DC-9 June 3, 2019
DC-10 June 3, 2019
HS-1 June 3, 2019
HS-2 June 3, 2019

EXIT DEVICES

ED-1 June 3, 2019
ED-2 June 3, 2019
ED-3 June 3, 2019
ED-4 June 3, 2019
ED-5 June 3, 2019
ED-6 June 3, 2019
ED-7 June 3, 2019
ED-8 June 3, 2019
ED-9 June 3, 2019
ED-10 June 3, 2019
ED-11 June 3, 2019
ED-12 June 3, 2019
ED-13 June 3, 2019
ED-14 June 3, 2019
ED-15 June 3, 2019

ED-16 June 3, 2019
ED-17 June 3, 2019
ED-18 June 3, 2019
ED-19 June 3, 2019
ED-20 June 3, 2019
ED-21 June 3, 2019
ED-22 June 3, 2019
ED-23 June 3, 2019
ED-24 June 3, 2019
ED-25 June 3, 2019
ED-26 June 3, 2019
ED-27 June 3, 2019
ED-28 June 3, 2019
ED-29 June 3, 2019
ED-30 June 3, 2019
ED-31 June 3, 2019
ED-32 June 3, 2019
ED-33 June 3, 2019
ED-34 June 3, 2019
ED-35 June 3, 2019
ED-36 June 3, 2019
ED-37 June 3, 2019
ED-38 June 3, 2019
ED-39 June 3, 2019
ED-40 June 3, 2019
ED-41 June 3, 2019
ED-42 June 3, 2019
ED-43 June 3, 2019
ED-44 June 3, 2019
ED-45 June 3, 2019
ED-46 June 3, 2019
ED-47 June 3, 2019
ED-48 June 3, 2019
ED-49 June 3, 2019
ED-50 June 3, 2019
ED-51 June 3, 2019
ED-52 June 3, 2019
ED-53 June 3, 2019
ED-54 June 3, 2019
ED-55 June 3, 2019
ED-56 June 3, 2019
ED-57 June 3, 2019
ED-58 June 3, 2019
ED-59 June 3, 2019
ED-60 June 3, 2019
ED-61 June 3, 2019
ED-62 June 3, 2019
ED-63 June 3, 2019
ED-64 June 3, 2019
ED-65 June 3, 2019
ED-66 June 3, 2019

ED-67 June 3, 2019
ED-68 June 3, 2019
ED-69 June 3, 2019
ED-70 June 3, 2019

AUXILIARY LOCKS

AL-1 June 3, 2019
AL-2 June 3, 2019
AL-3 June 3, 2019
AL-4 June 3, 2019
AL-5 June 3, 2019
AL-6 June 3, 2019
AL-7 June 3, 2019
AL-8 June 3, 2019

SPECIALTY HARDWARE

SP-1 June 3, 2019
SP-2 June 3, 2019
SP-3 June 3, 2019
SP-4 June 3, 2019
SP-5 June 3, 2019
SP-6 June 3, 2019
SP-7 June 3, 2019
SP-8 June 3, 2019
SP-9 June 3, 2019
SP-10 June 3, 2019
SP-11 June 3, 2019
SP-12 June 3, 2019
SP-13 June 3, 2019
SP-14 June 3, 2019

ELECTRICAL

EL-1 June 3, 2019
EL-2 June 3, 2019
EL-3 June 3, 2019
EL-4 June 3, 2019
EL-5 June 3, 2019
EL-6 June 3, 2019
EL-7 June 3, 2019
EL-8 June 3, 2019
EL-9 June 3, 2019
EL-10 June 3, 2019
EL-11 June 3, 2019
EL-12 June 3, 2019

PROFILE SERIES

PS-1 June 3, 2019
PS-2 June 3, 2019
PS-3 June 3, 2019
PS-4 June 3, 2019
PS-5 June 3, 2019
PS-6 June 3, 2019

PS-7 June 3, 2019
PS-8 June 3, 2019
PS-9 June 3, 2019
PS-10 June 3, 2019
PS-11 June 3, 2019
PS-12 June 3, 2019
PS-13 June 3, 2019
PS-14 June 3, 2019
PS-15 June 3, 2019
PS-16 June 3, 2019

MULTI-POINT LOCKING HARDWARE

MP-1 June 3, 2019
MP-2 June 3, 2019
MP-3 June 3, 2019
MP-4 June 3, 2019
MP-5 June 3, 2019

COMPANY NAME: _____

ADDRESS: _____

ATTN: _____

SARGENT®

ASSA ABLOY

Price Book No. 33

USA & Canada Prices Effective June 3, 2019

*THIS PRICE BOOK SUPERSEDES AND TAKES
PRECEDENCE OVER ANY OF OUR PRODUCT
CATALOGS IN TERMS OF PRODUCT AVAILABILITY.*

*CONTACT SARGENT MANUFACTURING CO. FOR PRICES AND
AVAILABILITY OF NON-STANDARD AND SPECIAL ITEMS NOT
LISTED IN THIS PRICE BOOK*

General Information

| | |
|-------------------------------------|---------------|
| USA Terms & Conditions | GI-1 - GI-5 |
| USA RGA Policy | GI-4 |
| USA Product Modification | GI-5 |
| Partner Services in Canada | GI-6 |
| Limited Warranty | GI-7 - GI-8 |
| Finishes | GI-9 |
| Merchandising Aids | GI-10 - GI-11 |
| Weight Charge - Screw Substitutions | GI-12 |
| Master Prefix Listing | GI-13 - GI-17 |
| Business Hours & Holiday Schedule | GI-18 |
| Who's Who at Sargent | GI-19 - GI-22 |
| Ordering Tips | GI-23 - GI-25 |
| Order Forms | GI-26 - GI-40 |

Cylinders & Keying

| | |
|--|---------------|
| How to Order / Key Control Types | CK-1 |
| Keying Charges | CK-2 - CK-3 |
| Key Charts, Key Wizard Software | CK-4 |
| Mortise, Rim Cylinders & Parts | CK-5 |
| Rings, Turn Knobs & Mail Box Cylinders | CK-6 |
| Cylindrical Lock Cylinders & Parts | CK-7 |
| SARGENT XC Series Cylinders | CK-8 - CK-9 |
| SARGENT Large Format Interchangeable Core Cylinders & Old Style Removable Core Cylinders | CK-10 |
| SARGENT XC - Large Format IC Core Cylinders | CK-11 |
| Small Format Interchangeable Core | CK-12 |
| XC - Small Format Interchangeable Core | CK-13 |
| Keying Kits, Tools, Gauges, Components | CK-14 |
| Keyblanks | CK-15 - CK-16 |
| SARGENT Cut Keys/Competitor Keyways | CK-17 |
| KESO F1 Security System | CK-18 - CK-22 |
| KESO System | CK-23 - CK-27 |
| Signature Key System | CK-28 - CK-31 |
| Degree Key System | CK-32 - CK-38 |

Bored Locks

| | |
|--|---------------|
| How to Order / ANSI Finish & Function Comparison | BL-1 |
| T-Zone (11 Line) | BL-2 - BL-15 |
| 10 Line | BL-16 - BL-27 |
| 7 Line | BL-28 - BL-35 |
| 6500 Line | BL-36 |
| DL Series | BL-37 - BL-45 |
| RDL Series | BL-44 - BL-45 |
| 8X Line | BL-46 - BL-47 |
| 6 Line | BL-48 - BL-51 |

Mortise Locks 7800/8200

| | |
|--|-----------------|
| How to Order / ANSI Finish & Function Comparison | ML-1 |
| 8200 Line (levers) | ML-2 - ML-75 |
| 7800 Line (Knobs) | ML-76 - ML-87 |
| 8200 Deadlocks | ML-88 |
| Distributor Bulk Pack Trim Program | ML-89 - ML-92 |
| 7800/8200 Lockbodies | ML-93 |
| 7800/8200 Working Trim Sets | ML-94 - ML-105 |
| 7800/8200 Assemblies & Parts | ML-106 - ML-118 |
| How to Order / ANSI Finish & Function Comparison | ML-119 |
| 7900 Mortise Lock | ML-120 - ML-152 |

High Security Mortise Lock 9200

| | |
|--|-----------------|
| How to Order - ANSI Finish & Function Comparison | ML-153 |
| 9200 & M9200 - Levers | ML-154 - ML-161 |
| 9200 & M9200 - Knobs | ML-162 - ML-169 |
| 9200 BHW | ML-170 - ML-171 |
| 9200 Deadlock, Lockbodies | ML-172 |
| 9200 Parts | ML-173 |
| 9200 Inside Trim Set | ML-174 |
| 9200 Outside Trim Set | ML-175 |

Multipoint Locking Hardware

| | |
|--|---------------|
| How to Order - ANSI Finish & Function Comparison | MP-1 |
| 7000 Series | MP-2 - MP-3 |
| AD7000 Series | MP-4 - MP-5 |
| WD7000 Series | MP-6 - MP-7 |
| ER/ES/ET Lever Control Trim | MP-8 - MP-9 |
| 7000 Strikes, Locking Slide & Spindle Kits | MP-10 |
| Parts | MP-11 |
| FM6100 Series | MP-12 - MP-13 |
| FM7300 Series | MP-14 - MP-23 |

Door Closers/holders & Stops

| | |
|--|--------------|
| How to Order / ANSI Finish & Function Comparison | DC-1 |
| Additional Features | DC-2 |
| 1431 / 281 / 351 Series | DC-3 |
| 268, 269, 281 Security Package Closer | DC-4 |
| 422 Cam Action Door Closer | DC-4 |
| 268, 269, 278 Concealed Closers | DC-4 |
| Finish Options | DC-5 |
| Arms & Accessories | DC-6 |
| Bodies/Covers/Retrofit Kits | DC-7 |
| 1331 / 1131 Series | DC-8 |
| Parts | DC-9 - DC-10 |
| Overhead Holders & Stops | HS-1 |
| Electromagnetic Holders & Stops | HS-2 |

Exit Devices

| | |
|--|---------------|
| How to Order - ANSI Finish & Function Comparison | ED-1 |
| 20 Series | ED-2 - ED-3 |
| 30 Series | ED-4 - ED-5 |
| 9898 Reversible Stocking Exit | ED-6 - ED-7 |
| 80 Series | ED-8 - ED-37 |
| 9400 Series | ED-38 - ED-39 |
| 90 Series | ED-40 - ED-45 |
| Trim | ED-46 - ED-49 |
| 8893/8895 Inactive & Active Push Bars | ED-50 - ED-51 |
| Mullions & Accessories | ED-52 - ED-56 |
| Parts | ED-57 - ED-70 |

Auxiliary Locks

| | |
|----------------------------------|------|
| 470 SSL1 Series | AL-1 |
| 480 Series | AL-2 |
| 4870 Series | AL-3 |
| 460-480-4870 Strikes & Parts | AL-4 |
| 4870 Parts | AL-5 |
| Locker, Utility, & Cabinet Locks | AL-6 |
| 758 Padlock & Parts | AL-7 |
| 858 Padlock & Parts | AL-8 |

TOC-2

TABLE OF CONTENTS



USA & Canada Price Effective June 3, 2019

Specialty Hardware

| | |
|--|-------|
| HP Series Tubular Lock with Push/Pull (ALP) | |
| Trim & Options | SP-1 |
| 114/115 Series with Push/Pull Trim & Options | SP-2 |
| 114/115 Push/Pull Parts | SP-3 |
| 8200 Series PUSH/PULL Trim (ALP) Options | SP-4 |
| 8200 Series PUSH/PULL Trim (ALP) | SP-5 |
| 8200 Series BHL Trim Options | SP-6 |
| 8200 Series BHL Trim | SP-7 |
| 8200 Series BHW Trim Options | SP-8 |
| 8200 Series BHW Trim | SP-9 |
| 7800 Series Push/Pull Trim(PT) Options | SP-10 |
| 7800 Series Push/Pull Trim(PT) | SP-11 |
| 7800 Series BHD Trim Options | SP-12 |
| 7800 Series BHD Trim | SP-13 |
| 7800 Series BHD IS and OS Trim | SP-14 |

Electrical

| | |
|--------------------------------------|---------------|
| Electro-Mechanical Locksets | EL-1 |
| Electro-Mechanical Exits | EL-2 |
| ElectroLynx / Wiring Diagram Service | EL-3 |
| Electronic Accessories | EL-4 - EL-7 |
| Alarms - 5100/5800 | EL-8 - EL-9 |
| Fire Guard Door Closers | EL-10 |
| Parts | EL-11 - EL-12 |

Profile Series - Stand Alone Products

| | |
|--|---------------|
| How to Order / ANSI Finish & Function Comparison | PS-1 |
| 10 Line Cylindrical Lock - KP, G1, RF | PS-2 - PS-3 |
| 8200 Series Mortise Lock - KP, G1, RF | PS-4 - PS-7 |
| 80 Series - Exit Device - KP, G1, RF | PS-8 - PS-9 |
| Accessories | PS-10 |
| Parts & Accessories | PS-11 |
| 10 Line Parts & Accessories | PS-12 |
| 8200 Series Parts & Accessories | PS-13 - PS-14 |
| 80 Series Trim & Trim Kits | PS-15 |
| 80 Series Parts & Accessories | PS-16 |

USA & Canada Prices Effective June 3, 2019

GENERAL INFORMATION

| | | | |
|---|-------|---|-------|
| USA Terms and Conditions..... | GI-1 | Keying Order Form..... | GI-27 |
| USA Terms and Conditions..... | GI-2 | Keying Order Form..... | GI-28 |
| USA Terms and Conditions..... | GI-3 | Keying Order Form..... | GI-29 |
| USA Terms and Conditions..... | GI-4 | Locksets Order Form | GI-30 |
| USA Terms and Conditions..... | GI-5 | Exit Devices Order Form..... | GI-31 |
| Partner Services in Canada | GI-6 | Door Closers Order Form..... | GI-32 |
| Limited Warranty | GI-7 | Miscellaneous Items Order Form..... | GI-33 |
| Limited Warranty | GI-8 | Signature Series Order Form | GI-34 |
| Finishes | GI-9 | KESO Authorized Signature Form | GI-35 |
| Merchandising Aids..... | GI-10 | KESO Authorization Form..... | GI-36 |
| Merchandising Aids..... | GI-11 | KESO 24 Hour Key Order Form | GI-37 |
| Weight Chart - Screw Substitutions | GI-12 | Key Wizard™ Registration Form..... | GI-38 |
| Master Option Listing (1-26)..... | GI-13 | Degree™ System Information Document | GI-39 |
| Master Option Listing (28-65737P) | GI-14 | Degree™ DG1, DG2, DG3 | |
| Master Option Listing (68-83)..... | GI-15 | Required Administrative Documents..... | GI-40 |
| Master Option Listing (84-SC)..... | GI-16 | | |
| Master Option Listing (SE-WS)..... | GI-17 | | |
| Business Hours, Holiday Schedule, Website Information, Partner Services in USA | GI-18 | | |
| Who's Who at SARGENT | GI-19 | | |
| Who's Who at SARGENT | GI-20 | | |
| Who's Who at SARGENT | GI-21 | | |
| Who's Who at SARGENT | GI-22 | | |
| Ordering Tips and SARGENT Key Systems Security Policy..... | GI-23 | | |
| Ordering Tips and Keying Authorization Documentation | GI-24 | | |
| Ordering Tips..... | GI-25 | | |
| SARGENT Order Lead Sheet Check List | GI-26 | | |

Acceptance

SARGENT® reserves the right to decline an order, in whole or in part, when the type or quantity of goods or credit worthiness of the Purchaser is not satisfactory to us in our sole and absolute discretion.

Purchase Orders, QUOTE requests, Acknowledgements or the like issued by the Purchaser that have contrary standard terms and conditions are not binding on SARGENT®, unless such terms and conditions are approved in a separate written agreement by SARGENT's authorized representatives. In the event of an acceptance of Purchaser's Purchase Order by SARGENT®, the Purchaser agrees that such acceptance is solely conditioned on Purchaser's acceptance of the terms and conditions set forth in this instrument, regardless of the terms and conditions specified in the Purchaser's Purchase order. The terms and conditions in Purchaser's Purchase order which conflict with terms and conditions of this instrument shall be disregarded and are hereby rejected, and this instrument shall constitute the entire agreement between SARGENT® and the Purchaser.

In the event that SARGENT® does not enforce or require strict performance of any term or condition hereof, or of any other document, instrument or other agreement relating to goods sold, such lack of enforcement or requirement of strict performance will not waive, affect or diminish any right of SARGENT® to enforce or require strict performance of such term or condition in the future.

Prices

All prices are subject to change without notice and are not guaranteed. All shipments will be made at prices in effect at the time of order acceptance.

Possession of this price list does not constitute an agreement to sell.

We reserve the right to correct clerical, stenographic and other obvious errors at any time.

Terms:

2% tenth net 30 days after statement date.

It is understood that SARGENT® may impose and charge a finance charge which is the lesser or one and one-half percent (1-1/2%) per month or the highest rate allowed by law on any amount which becomes past due and delinquent. Additionally the Customer shall be responsible for all collection costs, court costs and reasonable attorney's fees (where allowed by law) in connection with the recovery of any delinquent amount.

Freight

All orders are shipped FOB factory/warehouse, except as expressly provided below. When delivered to the Transportation Company, the Purchaser assumes the risk of loss or damage in transit.

Customer orders with net product value in excess of \$12,000.00 will be shipped prepaid by SARGENT's carrier of choice to a single destination point in the United States.

Customer orders with net product value less than \$12,000.00 will be shipped prepaid by SARGENT's carrier of choice and freight and handling charges will be added to the customer's invoice.

A minimum freight and handling charge of \$15 will be charged on orders with net product value of \$400 or less. The minimum freight and handling charge will not apply to orders for only Cut (bitted) keys of any type, Master keys, Master keyed cylinders or padlocks and factory generated bitting lists that do not have any other product types included on the order. Freight on these orders will be charged as the percentage of invoice value.

For orders with net product value greater than \$400 and less than \$12,000, freight charges will be calculated as a percentage of the net invoice value and will be added to Customer's invoice. The percentage is based on the National U.S. Average On Highway Diesel Fuel Prices as reported by the US Department of Energy in effect at the beginning of each quarter. On the first Monday of each quarter, the new rate will be published on the SARGENT and Door Security Solutions extranet and will go into effect on the 2nd Monday of the quarter. Please refer to the Sargent distributor extranet for the rate chart and information on the current freight charge percentage. The percentage in effect at the time of shipment of the order will be charged.

Great Grand Master keys, Grand Master keys, Master keys, Construction Master keys, Control Keys, Lot Day Keys which are shipped separate from customer order for security reasons, on orders with total net product value in excess of \$12,000.00 will be shipped prepaid by SARGENT's carrier of choice. If the total order value is less than \$12,000, the shipping charges will be added to Customer's invoice.

USA TERMS & CONDITIONS

USA & Canada Prices Effective June 3, 2019

If a customer provides their own freight account # or freight collect for the freight charges, SARGENT will apply a handling fee of \$25 to the invoice.

Turbo Orders – All 1-Week Turbo orders are guaranteed to ship from SARGENT 5 working days after receipt of all information necessary to process order or SARGENT will pay freight costs. If Turbo is held for credit reasons SARGENT will not be responsible for freight costs.

Expedited shipping options – If the customer requests an expedited method of shipment such as “Next Day Air” the charges will be prepaid by SARGENT and the full rate for the service, as published by the carrier, will be added to the customer’s invoice.

Packing – SARGENT will pack, mark and ship the products according to its standard procedures for shipment, unless the parties agree, in writing, that SARGENT will comply with any special instructions provided by the customer. Special instructions must be submitted, in writing, at time of order placement. Compliance with special instructions may result in an increased price.

Minimum Invoice:

Minimum order value for complete product is \$250 net product value. The minimum order value for parts orders is \$100 net product value. In the event that the net product value does not meet the required net minimum, Sargent may, at its sole discretion (a) apply a minimum order charge, (b) reject the order or (c) waive the minimum requirement provided that the waiver of the requirement for one order shall not constitute a waiver of the requirement for any future orders.

The following products are exempt from this policy: Cut (bitted) keys of any type, Master keys, Master keyed cylinders or padlocks and factory generated bitting lists.

Quotations:

Complete shipment of the order must be accepted by Purchaser within normal shipping lead times.

The QUOTE number must be referenced on the order.

Any invoiced order that has the incorrect discount applied to it and did not have a QUOTE copy attached to the order or the QUOTE number written on the order will have a service fee of \$100.00 net DEDUCTED from any sales credit issued for the difference in discount.

The QUOTE is null and void if the Purchase Order does not include **ALL** product lines listed on the QUOTE or if the quantities for an item covered by the QUOTE deviate by **10%** or more.

With the issuance and acceptance of a QUOTE for the purchase of products, the Purchaser agrees that products so purchased will not be resold or transferred to any Distributor not authorized by SARGENT® to sell its products. This would be inclusive of branches of the quoted Distributor. Failure to abide by this restriction may result in the Distributor’s ineligibility for Price Concession Authorizations, or other actions in SARGENT’s discretion.

SARGENT® and its sales representatives reserve the right, in their sole discretion and for any reason, to refuse a Distributor’s request to quote a price other than SARGENT’s standard list price and regardless of whether SARGENT® or its sales representatives have previously quoted discounted prices to the Distributor on some or all of its orders.

Non-Cataloged Products:

Products not cataloged or listed in this price book will be considered as special products, and will not be manufactured without prior approval from SARGENT®. All non-cataloged goods cannot be changed or cancelled.

A minimum special handling charge of **\$50.00** will be added for non-cataloged product. Any additional labor or material required will be charged accordingly.

Special products require special handling, and therefore standard lead times may not apply. Please consult with your Sales Representative for further details.

Changes / Cancellation of Orders:

Changes or cancellations to an order will result in a charge of costs for material and labor expenses that have been incurred prior to notification from Customer. If products have already been made and or are located in the shipping room, the 45% restocking fee will apply. Handling charges are billed on Customer's original order.

Suspended Line Items:

If a line item is suspended due to insufficient information, we will notify you via "Q" fax. If a response is not received within 5 business days of the fax, the item(s) will be cancelled off the order. A new order will need to be placed for the cancelled item(s).

Add-On Orders to QUOTE:

Any new order requesting special pricing to match an existing QUOTE number, which has already been ordered, will be accepted up to 60 days after the acknowledgement of the original order. All add-on orders must reference the original factory order number and the corresponding QUOTE number to receive the quoted pricing discount. Add-on orders for stock will not be accepted.

Packaging:

Many items are defined as to Case Lot Packaging or Minimum Order. The case lot policy does not apply to hardware to be used on a specific hardware project.

Delivery:

Orders will be acknowledged and given a scheduled delivery date based on estimated manufacturing lead times. Complete information is required to process all orders. Orders with insufficient information for processing (i.e. keying information, door sizes, etc.) may be subject to extended lead times which are relative to the time required in obtaining the necessary information for order processing. Manufacturing lead time will begin once all information is received to process an order. SARGENT® will use reasonable efforts to deliver products as estimated, but makes no guarantee's as to delivery dates.

SARGENT® will not be liable for back charges incurred based on availability of product or as a result of delays in delivery caused by insufficient information required to process an order.

SARGENT® will not be held responsible for delays in delivery caused by strikes, fires, floods or any other causes beyond our control, including the delivery of material to us. Under no circumstances shall SARGENT® be liable or accountable for consequential damages due to failure of delivery.

Claims:

In the event of Company or Customer error, claims for shortages, pricing errors and/or incorrectly filled orders must be submitted in writing to Customer Service within thirty **(30)** days from receipt of material.

Any claims for shortages or damage by the Carrier must be made by the Customer directly to the Carrier.

Limited Carrier insurance is typically offered for all orders. If the Customer requires additional insurance, please contact a SARGENT® Customer Service Representative upon submittal of the order. SARGENT® will obtain requested insurance and the additional cost will be included on Customer's invoice.

Invoice Deduction:

A SARGENT® Sales Representative or Customer Service Representative must be notified of any disputed invoices within sixty **60** days from the date of invoice. Deductions should only be taken for the disputed amount and the balance of the invoice is due and payable within standard payment terms.

USA TERMS & CONDITIONS

USA & Canada Prices Effective June 3, 2019

Returned Goods:

It is the policy of SARGENT® to **not** accept returns of any materials that are correctly furnished as per the Distributor's Purchase Order. Return of product due to customer order error or accommodation must be pre-arranged with SARGENT® and approved in writing by Sales Management.

No Returns Accepted for the following: KESO, Signature, Degree, Keyed Cylinders, Specials, Anything Used, Discontinued, Modified, or Damaged Product, Electrical products, Incomplete Products (e.g. missing keys, levers, roses, etc).

All products returned as "Goodwill" must meet the following criteria to be considered a return:

- Be in original, unmarked, and undamaged cartons.
- Be valued in excess of \$250.00 net.
- Shipped and invoiced within the previous 120 days.
- Custom, non-cataloged goods, master-keyed or SARGENT® Turboship product is not returnable.

A **MINIMUM** restocking fee of **45%** will be charged. Upon receipt and verification by SARGENT® that the returned merchandise meets the foregoing conditions, a credit will be issued for the original invoice amount less the **MINIMUM 45%** restocking fee.

Defective goods and "Goodwill" products that meet the foregoing criteria, may be returned by fulfilling the following conditions:

- Send an RGA request in writing to the SARGENT® Sales Representative serving the Purchaser's area.
- Ensure the RGA labels that are sent to Purchaser by SARGENT® are visible on return goods shipment.
- Ensure that the RGA number appears on the return shipment label and is legible.
- Return the authorized merchandise within sixty (**60**) days from the date of RGA issuance date.
- Return shipments must be freight prepaid to the location specified on the RGA. SARGENT® is not liable for damages or shortages to product during shipping.

Electro Mechanical Defective Product Returns:

In addition to the above, the following conditions apply:

- Defective product return must be under warranty
- Case # must be used within 7 days of issuance
- Returned product must be found defective or nonfunctional upon test at factory
- Returned product must not have been damaged during installation process

No credit may be taken or issued prior to RGA approval and receipt of product.

All defective goods within the terms of our limited warranty may be returned for credit or replacement.

Taxes:

Prices do not include any present or future Federal, State, or Local property, license, privilege, sales, use, excise, gross receipts or other like taxes or assessments, which may result from transactions or any services performed in connection herewith.

Governing Law:

The rights and obligations of the parties shall be governed by the laws of the State of Connecticut, excluding any conflicts of law provisions. The United Nations Convention on Contracts for the International Sale of Goods shall not apply to this Agreement.

Limited Warranty:

The Terms and Conditions outlined above are subject to SARGENT® Limited Warranty, which is included in this Price List and incorporated herein by reference.

Product Modifications:

SARGENT® products are not designed for or intended for aftermarket modification. The warranty on SARGENT® products becomes void if the product is modified in any way, regardless of whether the modification causes or contributes to any alleged defect. Warranty voiding modifications include, but are not limited to, third-party electrification of non-electric products and/or the installation of non-approved or non-SARGENT® components.

If a SARGENT® product is modified it no longer meets industry certification and quality control standards applicable to the original product and is no longer a genuine SARGENT® product. A modified product may not be sold as a SARGENT® product and no SARGENT® trademarks or certification marks based on the original SARGENT® product, such as U.L. or ANSI/BHMA marks, may appear anywhere on the modified product or on any packaging, literature or instructions sold with the modified product.

All original SARGENT® packaging and literature carries SARGENT® trademarks and must be destroyed if the original SARGENT® product is modified. Portions of the product that carry a SARGENT® trademark or certification mark, such as mortise faceplates, lock bodies, etc. must be discarded and/or replaced by the party making the modification. U.L. and other certification testing and marking are also the responsibility of the party making modification. The use of SARGENT® trademarks on modified products constitutes trademark infringement.

Fire Rated Openings:

Any retrofit or other field modification to a fire rated opening can potentially impact the fire rating of the opening, and SARGENT makes no representations or warranties concerning what such impact may be in any specific situation. When retrofitting any portion of an existing fire-rated opening, or specifying and installing a new fire-rated opening, please consult with a code specialist or local code official (Authority Having Jurisdiction) to ensure compliance with all applicable codes and ratings.

Trademark Use Policy: ASSA ABLOY Americas

The following policy ("Policy") of ASSA ABLOY Americas ("ASSA ABLOY"), and all of its affiliated group companies (collectively, the "Group Companies"), applies to the use of certain intellectual property of all such Group Companies, including all trademarks, names, logos, product images, and related information (the "ASSA ABLOY Marks"). ASSA ABLOY Marks are proprietary and critical to the success of ASSA ABLOY and the Group Companies, and may only be used in strict compliance with this Policy.

This Policy covers any person or entity reselling any product of any Group Company with the consent of such Group Company (each, an "Approved Reseller"). Each Approved Reseller has a non-exclusive right to use certain of the ASSA ABLOY Marks relating to any of the Group Companies for which it is an Approved Reseller, subject to the following conditions:

- (1) Approved Reseller's use of ASSA ABLOY Marks must be truthful, fair, and not misleading;
- (2) Approved Reseller's advertising must clearly indicate that it is advertising of the Approved Reseller, and is not advertising of ASSA ABLOY;
- (3) Approved Reseller may not use any ASSA ABLOY Marks as part of or in connection with a domain name;
- (4) Approved Reseller's advertising must not imply or suggest an association between the Approved Reseller and ASSA ABLOY other than that of buyer and seller;
- (5) Approved Reseller's use of ASSA ABLOY Marks must be a positive representation of ASSA ABLOY, the Group Companies, and their products;
- (6) Approved Reseller's trade name must be more predominant on Approved Reseller's advertising than the ASSA ABLOY Marks;
- (7) Approved Reseller's use of ASSA ABLOY Marks must include the trademark symbol ® or TM, as appropriate, along with the following trademark legend printed in legible text on the Web page or document containing ASSA ABLOY Marks: "[describe ASSA ABLOY Marks] are trademarks or registered trademarks of ASSA ABLOY, Inc. or one of its affiliates in the United States and other countries.";
- (8) Approved Reseller must not make modifications of any ASSA ABLOY Marks; and
- (9) Approved Reseller may use only ASSA ABLOY Marks associated with the Group Companies for which it is an Approved Reseller (e.g., an Approved Reseller that sells Group Company X products but not Group Company Y products may use Group Company X trademarks in connection with its sale of Group Company X products, but may not use Group Company Y trademarks).

PARTNER SERVICES IN CANADA

USA & Canada Prices Effective June 3, 2019

PARTNER SERVICES IN CANADA

Business Hours: Customer Service Hours: 8:00 AM to 4:30 PM Eastern Standard Time.

Toll Free Telephone Number: 1-800-461-3007

Order Fax Number: 1-800.461.8989.

Order email: orders.dss.ca@assaabloy.ca

RGA email: rga.dss.ca@assaabloy.com

Technical Support email: techsupport.dss.ca@assaabloy.com

Customer Support: Ontario email: customerservice.dss.caontario@assaabloy.com

Customer Support: East email: customerservice.dss.caeast@assaabloy.com

Customer Support: West email: customerservicedss.cawest@assaabloy.com

2019 Canadian Calendar:

January 1: New Year's Day

January 24 : Inventory

February 18: Family Day

April 19: Good Friday

May 20: Victoria Day

July 1: Canada Day

August 5: Civic Holiday

September 3: Labor Day

October 14: Thanksgiving

December 25: Christmas Day

December 26: Boxing Day

For Terms & Conditions and Warranty information pertaining to product sales in Canada, please visit www.assaabloy.ca/terms.

Note that some products may not be available in Canada as well as some of the programs offered in this price book may differ between the USA and Canada. Please contact your sales representative for more information.

ASSA ABLOY reserves the right to review Approved Reseller's usage of ASSA ABLOY at any time and may:

- (a) require changes to the use of ASSA ABLOY Marks at any time in its sole discretion, which changes must be implemented within 30 days of written notice to Approved Reseller;
- (b) condition the use of ASSA ABLOY Marks on ASSA ABLOY's prior approval use, which approval may be withheld in its sole discretion;
- (c) revoke permission to use ASSA ABLOY Marks at any time for any or no reason days prior written notice to Approved Reseller; and
- (d) revoke permission to use ASSA ABLOY Marks immediately upon notice to Reseller in the event Approved Reseller is in violation of this Policy, or of any agreement with ASSA ABLOY or any Group Company.

Approved Reseller's right to use ASSA ABLOY Marks in no way conveys to Approved any proprietary or economic interest in any ASSA ABLOY Marks.

Use of ASSA ABLOY Marks in violation of this Policy may result in severe civil and liabilities. ASSA ABLOY will vigorously enforce this Policy by seeking all appropriate remedies, including, but not limited to, pecuniary damages and injunctive relief.

TECHNICAL INFORMATION AND ADVICE:

- (a) All designs, data and specifications provided by company are proprietary and will not be disclosed or reused by customer without the prior written consent of Company;
- (b) Company assumes no obligation or liability for any advice given by Company, the results obtained, or damages incurred, and all such advice is given and accepted at Customer risk.

LIMITED WARRANTY:

SARGENT® warrants that its products sold under the "SARGENT" trade name in the United States of America are free from defects in workmanship and materials under normal use and service.

This warranty does not cover defects or damage arising from improper installation, lack of or improper maintenance, improper storage, shipping and handling, corrosion, erosion, ordinary wear and tear, misuse, abuse, accident, unauthorized service, or use with unauthorized non-SARGENT products or parts.

This warranty is void if any modification is made to the warranty product, regardless of whether the modification causes or contributes to the alleged defect. All modifications are made at the risk of the party making the modification.

The only liability of SARGENT®, in tort or contract whether under this warranty or otherwise, shall be limited to the repair or replacement of any product or component part which shall prove defective as covered by this warranty, within the stated time period listed below, after delivery to the original purchaser.

| | |
|---|----------|
| • T-Zone (11-Line) Bored-In Lever Lock | 10 years |
| • 281, 351, 1431, 1331 Series Closer Body | 25 years |
| • 1131 Series Closer Body | 15 years |
| • 268, 269, 278, 422 Series Closer Body | 10 years |
| • 9200/8200/7800 Mortise Lock | 10 years |
| • FM6100, FM7300, 10L Bored-In Lever Lock | 7 years |
| • 7000 Vertical Rod Lock, 7900 Mortise Lock | 5 years |
| • 80 Series/Exit Trim/90 Series Exit Device, 56- Electric Latch Retraction Option | 5 years |
| • Overhead Holders & Stops | 5 years |
| • 7L Bored-In Lever Lock | 5 years |
| • 8X Line Bored-In Knob Lock | 3 years |
| • 20/30 Exit Device or Trim | 3 years |
| • All Electromechanical and Electronic Products | 2 years |
| • All other SARGENT products | 1 year |

**CYLINDER SERVICE FEE
AND LIMITED WARRANTY**

USA & Canada Prices Effective June 3, 2019

Cylinders for Competitor Products:

SARGENT cylinders or cores for use in non-SARGENT manufactured locking devices for which SARGENT has an equivalent, will be assessed an additional Cylinder Service Fee. This fee applies to masterkeyed cylinder only orders, 1 bitted high security cylinders and zero or 1 bitted restricted cylinder orders

Warranty for Cylinders Factory or Field Combined:

Cylinders shall be periodically lubricated depending on environmental conditions. Dry graphite, molybdenum disulfide or Polyube(trademark) are recommended. Petroleum based liquid lubricants should only be used in cylinders in harsh or corrosive environments and should not be mixed with dry lubricants.

SARGENT® cylinders and/or core warranty will be voided if used in non-SARGENT® locking devices.

Warranty for Cylinders Field Combined:

1. Keys shall be cut to the SARGENT® key biting specifications required for the particular keyway and depth system.
2. All pin lengths shall be selected according to prevailing factory standards.
3. Original SARGENT® cylinder components, including pin tumblers and key blanks, shall be used.
4. We reserve the right to void the warranty if we deem that a malfunction is a result of non-original components which do not conform to SARGENT® standards.

Keying Systems:

All bittings shall be originated by the SARGENT® Key Systems Department to be compatible with one another in a specific type of cylinder (conventional, security, high security, interchangeable core, removable core) and within a particular keying system.

SARGENT® will not pay for the cost of repair performed other than in accordance with this warranty.

SARGENT® will not be held responsible in any way for any field generated biting systems.

Refer to our Returned Goods Policy regarding the return of a product or component part believed to be defective as covered by this warranty. A brief description of the defect will be required. Product will be examined upon return. In the event such examination reveals a defect covered by this warranty, the product will be repaired or replaced.

THIS WARRANTY IS IN LIEU OF ALL OTHER EXPRESS WARRANTIES. TO THE EXTENT PERMITTED BY LAW, ALL IMPLIED WARRANTIES ARE LIMITED TO THE DURATION OF THIS WARRANTY. SARGENT® MANUFACTURING COMPANY SHALL NOT BE LIABLE FOR ANY INCIDENTAL OR CONSEQUENTIAL DAMAGES. NO AGENT, SALES REPRESENTATIVE OR DEALER HAS THE AUTHORITY TO INCREASE OR ALTER THE OBLIGATIONS OF THIS WARRANTY.

SOME STATE DO NOT ALLOW LIMITATIONS ON HOW LONG AN IMPLIED WARRANTY LASTS OR THE EXCLUSION OR LIMITATION OF INCIDENTAL OR CONSEQUENTIAL DAMAGES, SO THE ABOVE LIMITATIONS OR EXCLUSIONS MAY NOT APPLY TO YOU.

THIS WARRANTY GIVE YOU SPECIFIC LEGAL RIGHTS, AND YOU MAY ALSO HAVE OTHER RIGHTS WHICH VARY FROM STATE TO STATE.

SARGENT® Manufacturing Company

Finishes

Items will be furnished only in finishes as listed in this price book. Not all finishes are available for all product lines. Consult each product section for applicable finishes.

| SARGENT Symbol | BHMA Symbol | Material |
|-----------------------|--------------------|--|
| 3 | (BHMA 605) | Bright brass, clear coated |
| 4 | (BHMA 606) | Satin brass, clear coated |
| 9 | (BHMA 611) | Bright bronze, clear coated |
| 10 | (BHMA 612) | Satin bronze, clear coated |
| 10B | (BHMA 613) | Dark oxidized satin bronze, oil rubbed |
| 10BE | (BHMA 613E) | Dark oxidized satin bronze - equivalent |
| 10BL | (BHMA 614) | Dark oxidized satin bronze, clear coated |
| 14 | (BHMA 618) | Bright Nickel, clear coated |
| 15 | (BHMA 619) | Satin Nickel, clear coated |
| 20D | (BHMA 624) | Statuary bronze dark powder coated |
| 26 | (BHMA 625) | Bright chromium plated |
| 26D | (BHMA 626) | Satin chromium plated |
| 32 | (BHMA 629) | Bright stainless steel |
| 32D | (BHMA 630) | Satin stainless steel |
| BSP | n/a | Black suede powder coat |
| WSP | n/a | White suede powder coat |

Exposed Metal Parts Furnished same finish as Escutcheon or Rose Bushing

| SARGENT Symbol | BHMA Symbol | Painted Finishes |
|-----------------------|--------------------|--|
| EB | (BHMA 690) | Sprayed bronze enamel or polyester powder coated to match finish 10B |
| ED | (BHMA 693) | Sprayed black enamel or polyester powder coated to match finish 20D |
| EN | (BHMA 689) | Sprayed aluminum enamel or polyester powder coated |
| EP | (BHMA 691) | Sprayed bronze enamel or polyester powder coated to match finish 10 |
| EAB | (BHMA 696) | Brass enamel or polyester powder coated to be used with brass finishes |
| ERD | | Red powder coat |

When prime coat is required the EN finish will be furnished as this is suitable for painting.

GI-10 GENERAL INFORMATION

SARGENT®

ASSA ABLOY

MERCHANDISING AIDS

USA & Canada Prices Effective June 3, 2019

Note: Sample mounts only. Hardware needs to be ordered separately.

| Cylinder | | Price |
|---|---|----------|
| DG-3110 | Degree Cylinder Sample Kit | \$250.00 |
| Bored Lock (Solid Light Oak Block) | | |
| MSB001 | 6 and 8 Line Bored Locks And 480 Deadlock – 2-3/4" Backset Only | \$167.00 |
| MSB002 | 6500 / 7 / 10 Line Cylindrical Lock | \$178.00 |
| MSB007 | T-Zone (11 Line) Series Bored Lock | \$178.00 |
| MSB014 | DL Series | \$158.00 |
| 7800/8200/8200BHL/9200 Line Locks (Solid Light Oak Block) | | |
| MSM004 | 15 Function | |
| MSM005 | 05, 24, 25, 45, 50 Functions | \$490.00 |
| MSM003 | 04 & 37 functions | |
| MSM015 | 9200 Series | \$195.00 |
| Roseless Trim Locks (Maiman Thermal Fused flush door, Paraon Cherry Block) | | |
| MSM010 | R8237 Roseless | \$150.00 |
| MSM011 | Roseless 5 lever | \$670.00 |
| MSB012 | RDLU65 Roseless | \$99.00 |
| 8200 ALP Trim (Maiman Thermal Fused flush door, Gentle Anigre Block) | | |
| MSB013 | HP Series ALP | \$132.00 |
| MSM012 | 8215 ALP | |
| MSM013 | 8205, 25, 45, 50 ALP | \$217.00 |
| MSM014 | 8204& 37 ALP | |
| 8200 BHW Trim | | |
| MSM023 | Passage | |
| MSM024 | Cylinder | \$260.00 |
| MSM025 | Cylinder and Turn Button | |
| 4870 Line Locks (Solid Light Oak Block) | | |
| MSM001 | 4875/77 Series | |
| MSM002 | 4874 Series | \$179.00 |
| MSB009 | SSL1 | |
| 114 and 115 Hospital Latch | | |
| MSB010 | Solid Light Oak Block for 2 -3/4" Backset only | \$146.00 |
| Exit Devices (Solid Light Oak Block) | | |
| MSE006 | 8810 only (E- size rail only) | |
| MSE018 | 9710 only | \$324.00 |
| MSE019 | 9800 with STS trim | |
| MSE020 | 9900 with STS trim | |
| Door Closers (Solid Light Oak Block) | | |
| MSD001 | 351 Series – "O" Arm Only | \$364.00 |
| MSD002 | 1431 Series – "O" Arm Only | \$364.00 |
| MSD003 | 281 Series – "O" Arm Only | \$337.00 |
| MSD004 | 1131 Series | \$364.00 |

USA & Canada Prices Effective June 3, 2019

Note: Sample mounts only. Hardware needs to be ordered separately.

| Electronic Access Control Products | | |
|---|--|----------|
| MSB003 | 10 Line – Keypad KP & KU | \$205.00 |
| MSB004 | 10 Line – Harmony | \$225.00 |
| MSB005 | 10 Line – Passport | \$200.00 |
| MSB006 | 10G77 – Low Profile (Bored-in) | \$271.00 |
| MSE002 | 59-80 Series Exit Device | \$310.00 |
| MSE003 | 8800 Series Passport | \$310.00 |
| MSE004 | 8900 Series Passport | \$360.00 |
| MSE007 | 8876 – Low Profile (Rim Exit - LHR) | \$326.00 |
| MSE008 | HT-80 Series Exit | \$815.00 |
| MSE009 | 8800 Series Harmony | \$337.00 |
| MSE010 | 8900 Series Harmony | \$230.00 |
| MSE011 | 8600 Series Harmony | \$230.00 |
| MSE012 | 8700 Series Harmony | \$230.00 |
| MSE013 | KP 8900 Series Exit Device | \$310.00 |
| MSE014 | 56- (Electric Latch Retraction) 80 Series Exit Device | \$569.00 |
| MSE015 | 32" for 80 Series Rim | \$350.00 |
| MSE016 | 36" for 80 Series Rim | \$370.00 |
| MSE017 | NB-8700 Series Harmony | \$230.00 |
| MSE021 | KP-8800 Series | \$265.00 |
| MSM006 | 8200 Series - Passport | \$200.00 |
| MSM007 | KP 8200 Mortise Lock | \$286.00 |
| MSM008 | 8200 Series – Low Profile (Mortise) | \$318.00 |
| MSM009 | H1 8200 Series | \$318.00 |
| MSM016 | H1/H2 R8200 Series | \$405.00 |
| Aperio Hubs | | |
| MSA001 | AH20 Aluminum | \$300.00 |
| MSA003 | AH30 Aluminum | |
| Finish Samples | | |
| 1111 | Set of standard finishes on 11/4" diameter | \$56.00 |
| SFP1 | Sample Finish Plate | \$180.00 |
| Lever Sample Kit | | |
| 82-5365 | Kit includes foam insert & bag only. Levers ordered separately (US3, US4, US9, US10, US10B, US10BL, US14, US15, US20D, US26, US26D, US32, US32D, EB, ED, EN, EP, EAB) | \$160.00 |

GI-12 GENERAL INFORMATION

SARGENT®

ASSA ABLOY

WEIGHT CHART

USA & Canada Prices Effective June 3, 2019

Freight Weight Chart

Shipping weights listed depict an approximation of the average weight for any lock, exit device, or closer and are meant only for use in estimating weight.

Standard Packing

Product Line

| Locksets | Function | Case Quantity | Average Weight Per Case (lbs.) |
|------------------|-------------|---------------|--------------------------------|
| 7800 Line | 7805 w/trim | 6 | 42 |
| 7900 Line | 7904 w/trim | 6 | 42 |
| 8200 Line | 8205 w/trim | 6 | 42 |
| T-Zone (11 Line) | 11G05 | 10 | 45 |
| 10 Line | 10G05 | 10 | 45 |
| 7 Line | 7G05 | 10 | 41 |
| 6 Line | 6G05 | 10 | 21 |
| 6500 Line | 65G05 | 10 | 41 |

Exit Devices

| | | | |
|-----------|-------------|---|----|
| 90 Series | 9863 w/trim | 1 | 15 |
| 80 Series | 8863 w/trim | 1 | 15 |
| 20 Series | 2828F | 1 | 9 |

Closers

| | | | |
|-------------|-----|---|----|
| 351 Series | UO | 4 | 34 |
| 281 Series | O | 2 | 24 |
| 1431 Series | UO | 4 | 32 |
| 1331 Series | JUO | 4 | 30 |
| 1131 Series | RU | 4 | 22 |

Overhead Holders & Stops

| | | |
|------------------|---|---|
| 590/690 Series | 1 | 6 |
| 1530/1540 Series | 1 | 4 |

Screw Substitutions

Price

| | |
|--|----------------------------------|
| Machine screw in place of wood screw | No Extra Charge |
| Phillips head screws | No Extra Charge |
| Spanner head in place of standard screws, specify WS or MS (37- option) | See each product section for add |
| Six lobe security (Torx) screws (36- option) | See each product section for add |
| 82-3856 Spanner Bit Kit - (sizes 4, 6, 8, 10, 12 & 1/4"), (1/4" Driver) | \$120.87 Each |
| 82-3855 Torx Bit Kit - (sizes T8, T9, T10, T15, T20, T25, & T27), (7/16" Driver) | \$155.00 Each |

| Master Option List | | |
|--------------------|---|---|
| Option | Series Used | Description |
| 1 | 7L, 10L, 7800, 7900, 8200, 470 | 1-1/16" wide front for 1-3/8" doors |
| 3 | 8200, 9200 | Stainless Steel Hub |
| 5P | Cylinders for Conventional Key Systems | Cylinders for Conventional Key Systems |
| 9 | 2408, 2900 | Companion units to 12-2400, 12-2900 Fire Guards |
| 10 | 6, 7, 8X, 10, T-Zone, 6500, 7800, 7900, 8200, 9200, 7000, 20, 30, 80, 8888, 90, 9898, 470, 480, 4870, 758, 858, Keyswitch, KP10, 10ProfileSer., 10RF-Actuation, KP8200, 8200ProfileSer., 8200RF-Actuation, KP88, 88ProfileSer., 88RF-Actuation, KP89, 89ProfileSer., 89RF-Actuation | SARGENT Signature Key System |
| 11 | 6, 7, 8X, 10, T-Zone, 6500, 7800, 7900, 8200, 9200, 7000, 20, 30, 80, 8888, 90, 9898, 9800, 470, 480, 4870, 758, 858, Keyswitch, KP10, 10L Profile Ser., 10LRF-Actuation, KP8200, 8200ProfileSer., 8200RF-Actuation, KP88, 88 Profile Ser., 88RF-Actuation, KP89, 89 Profile Ser., 89RF-Actuation | SARGENT XC Key System |
| 12 | 20, 30, 83, 85, MD84, MD86, WD86, LS-LP-LR-86, 87, NB87, 88, 8888, 89, 90, 980, L980, KP88, 88ProfileSer., 88RF-Actuation, KP89, 89ProfileSer., | UL Fire Label |
| | 89RF-Actuation, 5800, 7000, 2408, 2900, DL, RDL | Fire Guard with Smoke Detector |
| 12HC | 8700 (all functions), 8800 (04, 10, 13, 15), 980 | UL Fire Label/Hurricane Code |
| 13 | 6, 470 | Lockset x Front & Strike with 1/4" Radius (2-3/8" Backset only) |
| | 1331, 1431, 268, 269, 278, 281, 351, 422 | Door Closer Body Only |
| 14 | 6500, 6, 7, DL | Full Lip Strike #505 |
| | 8700, 9700 | Sliding Bolt Bottom Case |
| 15 | 6, 470 | Drive-In Guarded Latchbolt (2-3/8" Backset Only) |
| 16 | 20, 30, 80, KP88, 88 Profile Ser., 88RF-Actuation, KP89, 89 Profile Ser., 89RF-Actuation | Cylinder Lockdown Feature |
| | 480 | 400 "T" Shaped Strike (2-3/4" x 1-1/8") |
| 17 | 6 | Lockset x 2-3/4" Backset x 2-1/4" x 1" Front |
| 19 | 80, KP88, 88 Profile Ser., 88RF-Actuation, KP89, 89 Profile Ser., 89RF-Actuation | Pushbar without Lexan Touchpad |
| 20 | 6500, 10, 480, DL | 2-3/8" Backset |
| 21 | 6, 7, 8X, 10, T-Zone, 6500, 7800, 7900, 8200, 9200, 7000, 20, 30, 80, 8888, 90, 9898, 470, 480, 4870, 758, 858, 4142, 4143, Keyswitch, KP10, 10 Profile Ser., 10RF-Actuation, KP8200, 8200 Profile Ser., 8200RF-Actuation, KP88, 88 ProfileSer., 88RF-Actuation, KP89, 89 ProfileSer., 89RF-Actuation | SARGENT Lost Ball Construction Key System |
| 22 | 6500, 6, 7, 8X, 10, T-Zone, 7800, 7900, 8200, 9200, 7000, 20, 30, 80, 8888, 90, 9898, 480, 4870, 758, 858, Keyswitch, KP10, 10 Profile Ser., 10RF-Actuation, KP8200, 8200 Profile Ser., 8200RF-Actuation, KP88, 88 Profile Ser., 88RF-Actuation, KP89, 89 Profile Ser., 89RF-Actuation | SARGENT Split Key Construction Key System (existing systems only) |
| 23 | 10, T-Zone, KP10, 10ProfileSer., 10RF-Actuation | 3-3/4" Backset |
| | 6 | 3-3/4" Backset x 2-1/4" x 1-1/8" Front |
| | 7800, 8200, 9200, 8300, 8900, KP8200, 8200ProfileSer., 8200RF-Actuation, KP89, 89ProfileSer., 89RF-Actuation | Flat 4-7/8" ANSI Strike |
| 24 | 6 | 2-3/4" Backset x 2-1/4" x 1-1/8" Front |
| | 114, 115 | 2-3/4" Backset |
| 25 | 10, T-Zone, KP10, 10ProfileSer., 10RF-Actuation | 5" Backset |
| | 6 | 5" Backset x 2-1/4" x 1-1/8" Front |
| 26 | 114, 115 | 7" Backset |
| 28 | 6500, 6, 7, 8X, 10, T-Zone, DL, 114, 115, KP10, 10ProfileSer., 10RF-Actuation | ANSI A-115.2.1971 Curved Lip Strike (#808) |
| | 470, 480 | ANSI A-115.2.1971 Flat Lip Strike (#408) |
| | 4870 | ANSI A-115.2.1971 Flat Lip Strike (#7710) |

GI-14 GENERAL INFORMATION

SARGENT®

MASTER OPTION LISTING

ASSA ABLOY

USA & Canada Prices Effective June 3, 2019

| Master Option List | | Description |
|--------------------|--|---|
| Option | Series Used | |
| 30 | 7, 10, T-Zone, KP10, 10ProfileSer., 10RF-Actuation | Lever to accept Schlage Cylinder-Cylinder is not provided |
| 31 | 8X, T-Zone, DL, 7800, 7900, 8200, 9200, 7000, 80, 90, 97, 98, 99, Holders & Stops | Special Thickness Doors (Specify door thickness) |
| 36 | Cylindrical, Mortise, Closers, 80, 97, 98, 99, Exits, Holders & Stops, Aux. Locks, Deadlocks, 114, 115, 5100, 5800, 351EHT, 7000 | 6-Lobe Security Head Screws |
| 37 | Cylindrical, Mortise, Closers, 80, 97, 98, 99, Exits, Aux. Locks, Deadlocks, 114, 115, 5100, 5800, 7000 | Spanner Head Screws |
| 41 | 10, T-Zone, KP10, 10ProfileSer., 10RF-Actuation | 3/4" Throw Latchbolt x 2-3/4" Backset |
| 42 | 9700, 9800, 9900 | |
| 43 | 80 | Flush End Cap |
| 47 | Cylinders | Special Cams |
| 48 | 480 | 488 Strike 3-5/8" x 1-1/4" |
| 49 | 7800, 8200 | Visual Status Indicator/Occupancy Indicator w/ Emerg. Release |
| 50 | 7800, 8200 | Secured Indicator Rose |
| | Cylinders | Hotel Function (Lockout) |
| 51 | 7800, 8200, 80, 97, 98, 99, 4870, 758, 858 | Old Style Removable Core Cylinders for Existing Systems only |
| 52 | 7800, 8200, 80, 97, 98, 99, 4870, 758, 858 | Old Style Removable Construction Core Cylinders for Existing Systems only |
| 53 | 83, 84, MD84, 85, MD86, WD86, 87, NB87, 88, 89, 7000 | Latchbolt Monitor Switch |
| 54 | 83, 84, MD84, MD86, WD86, 87, NB87, 88, 89, 97, 98, 99, 7000 | Internal Microswitch in ET Control |
| 55 | 30, 80 | Signal Switch in Rail |
| | 7000 | Monitor Inside Lever |
| 56 | 80 | Remote Dogging/Latch Retraction |
| 57 | 83, 84, MD84, 85, MD86, WD86, 87, NB87, 88, 89 | Delayed Action (Magnet ordered separate) |
| 58 | 80 | Electric Dogging |
| 59 | 83, 84, MD84, 85, MD86, WD86, 87, NB87, 88, 89 | Electroguard |
| BC59 | 83, 84, MD84, 85, MD86, WD86, 87, 88, 89 | Electroguard Boca Code (needs door status switch) |
| 60 | 6, 7, 10, T-Zone, 6500, 7800, 7900, 8200, 9200, 7000, 20, 30, 80, 8888, 90, 9898, 480, 4870, 758, 858, Keyswitch, KP10, 10ProfileSer., 10RF-Actuation, KP8200, 8200ProfileSer., 8200RF-Actuation, KP88, 88ProfileSer., 88RF-Actuation, KP89, 89ProfileSer., 89RF-Actuation | SARGENT Removable Disposable Construction Core |
| 63 | 6, 7, 10, T-Zone, 6500, 7800, 7900, 8200, 9200, 7000, 20, 30, 80, 8888, 90, 9898, 480, 4870, 758, 858, Keyswitch, KP10, 10ProfileSer., 10RF-Actuation, KP8200, 8200ProfileSer., 8200RF-Actuation, KP88, 88ProfileSer., 88RF-Actuation, KP89, 89ProfileSer., 89RF-Actuation | SARGENT Removable Core Cylinder |
| 64 | 6, 7, 10, T-Zone, 6500, 7800, 7900, 8200, 9200, 7000, 20, 30, 80, 8888, 90, 9898, 480, 4870, 758, 858, Keyswitch, KP10, 10ProfileSer., 10RF-Actuation, KP8200, 8200ProfileSer., 8200RF-Actuation, KP88, 88ProfileSer., 88RF-Actuation, KP89, 89ProfileSer., 89RF-Actuation | SARGENT Removable Construction Core Cylinder |
| 65 | 6300, 7300B | Uncombine Cores |
| 6573 | 7, 10, T-Zone, 6500, 7800, 7900, 8200, 9200, 7000, 20, 30, 80, 8888, 90, 480, 4870, KP10, 10ProfileSer., 10RF-Actuation, KP8200, 8200ProfileSer., 8200RF-Actuation, KP88, 88ProfileSer., 88RF-Actuation, KP89, 89ProfileSer., 89RF-Actuation | Small Format Interchangeable 6-Pin Uncombine Core |
| 65737P | 7, 10, T-Zone, 6500, 7800, 7900, 8200, 9200, 7000, 20, 30, 80, 8888, 90, 480, 4870, KP10, 10ProfileSer., 10RF-Actuation, KP8200, 8200ProfileSer., 8200RF-Actuation, KP88, 88ProfileSer., 88RF-Actuation, KP89, 89ProfileSer., 89RF-Actuation | Small Format Interchangeable 7-Pin Uncombine Core |

USA & Canada Prices Effective June 3, 2019

| Master Option List | | |
|--------------------|--|--|
| Option | Series Used | Description |
| 68 | 7900, 8200, 9200 | Lock furnished w/lever handle outside x knob inside |
| 69 | 7900, 8200, 9200 | Lock furnished w/lever handle inside x knob outside |
| 70 | 7, 10, T-Zone, 6500, 7800, 7900, 8200, 9200, 7000, 20, 30, 80, 8888, 90, 480, 4870, KP10, 10 Profile Ser., 10RF-Actuation, KP8200, 8200 Profile Ser., 8200RF-Actuation, KP88, 88 Profile Ser., 88RF-Actuation, KP89, 89 Profile Ser., 89RF-Actuation | Small Format Interchangeable Disposable Plastic Construction Core |
| 72 | 7, 10, T-Zone, 6500, 7800, 7900, 8200, 9200, 7000, 20, 30, 80, 8888, 90, 480, 4870, KP10, 10 Profile Ser., 10RF-Actuation, KP8200, 8200 Profile Ser., 8200RF-Actuation, KP88, 88 Profile Ser., 88RF-Actuation, KP89, 89 Profile Ser., 89RF-Actuation | Small Format Interchangeable 6-Pin Construction Core |
| 73 | 7, 10, T-Zone, 6500, 7800, 7900, 8200, 9200, 20, 30, 80, 8888, 90, 480, 4870, KP10, 10ProfileSer., 10RF-Actuation, KP8200, 8200 Profile Ser., 8200RF-Actuation, KP88, 88 Profile Ser., 88RF-Actuation, KP89, 89 Profile Ser., 89RF-Actuation | Small Format Interchangeable 6-Pin Core |
| 737P | 7, 10, T-Zone, 6500, 7800, 7900, 8200, 9200, 20, 30, 80, 8888, 90, 480, 4870, KP10, 10 Profile Ser., 10RF-Actuation, KP8200, 8200 Profile Ser., 8200RF-Actuation, KP88, 88 Profile Ser., 88RF-Actuation, KP89, 89 Profile Ser., 89RF-Actuation | Small Format Interchangeable 7-Pin Core |
| 74 | 7, 10, 11, 7800, 8200, 4870, 114, 115 | Lead Lining or Wrapping |
| 75 | 7, 10, T-Zone, 7800, 7900, 8200, 9200, KP10, 10ProfileSer., 10RF-Actuation, KP8200, 8200ProfileSer., 8200RF-Actuation | Milled Inside Lever, Knurled Inside Knob |
| | 6500 | Handicap Warning on Inside of Lever – Embossed Plastic backing |
| | 94, 7000 | Abrasive Strip on Rail |
| | 97, 98, 99 | Knurled Crossbar |
| 76 | 7, 10, T-Zone, 7800, 8200, 9200, KP10, 10ProfileSer., 10RF-Actuation, KP8200, 8200ProfileSer., 8200RF-Actuation | Milled Outside Lever, Knurled Outside Knob |
| | 6500 | Handicap Warning on Outside of Lever – Embossed Plastic backing |
| | 7900, 7000, 80, 97, 98, 99, KP88, 88ProfileSer., 88RF-Actuation, KP89, 89ProfileSer., 89RF-Actuation | Milled Outside Lever |
| | 7, 10, T-Zone, 7800, 7900, 8200, 9200, KP10, 10ProfileSer., 10RF-Actuation, KP8200, 8200ProfileSer., 8200RF-Actuation | Milled Both Levers, Knurled Both Levers |
| 77 | 6500 | Handicap Warning on Both Levers – Embossed Plastic backing |
| | 7000 | Abrasive Strip on Rail, Abrasive Coating on Lever |
| | 97, 98, 99 | Knurled Crossbar, Abrasive Coating on Lever |
| 78 | Mortise Cylinder | Exposed Barrel |
| 80 | 2900 | Adjustable Hold Open Switch |
| | 7L, 10L, T-Zone | Levers/Knobs to accept Keso and KesoF1 cylinders - no cylinders provided |
| 81 | 7800, 7900, 8200, 7000, 80, 90, 9898, 4870, KP8200, 8200ProfileSer., 8200RF-Actuation, KP88, 88ProfileSer., 88RF-Actuation, KP89, 89ProfileSer., 89RF-Actuation | Cylinder to accept Keso(83) and KesoF1(F183) removable core - no core provided |
| F182 | 7L, 10, T-Zone, 7800, 7900, 8200, 7000, 80, 90, 9898, 4870, 856/857 Padlocks, Keyswitch, KP8200, 8200ProfileSer., 8200RF-Actuation, KP88, 88ProfileSer., 88RF-Actuation, KP89, 89ProfileSer., 89RF-Actuation | SARGENT KESO Security Cylinder - Patented - NEW Key Systems |
| 82 | 7L, 10, T-Zone, 7800, 7900, 8200, 7000, 80, 90, 9898, 4870, 856/857 Padlocks, Keyswitch, KP8200, 8200ProfileSer., 8200RF-Actuation, KP88, 88ProfileSer., 88RF-Actuation, KP89, 89ProfileSer., 89RF-Actuation | SARGENT KESO Security Cylinder (Existing Systems only) |
| F183 | 7800, 7900, 8200, 7000, 80, 90, 9898, 4870, KP8200, 8200ProfileSer., 8200RF-Actuation, KP88, 88ProfileSer., 88RF-Actuation, KP89, 89ProfileSer., 89RF-Actuation | SARGENT KESO Security Removable Core Cylinder - Patented - NEW Key Systems |
| 83 | 7800, 7900, 8200, 7000, 80, 90, 9898, 4870, KP8200, 8200ProfileSer., 8200RF-Actuation, KP88, 88ProfileSer., 88RF-Actuation, KP89, 89ProfileSer., 89RF-Actuation | SARGENT KESO Security Removable Core Cylinder (Existing Systems only) |

GI-16 GENERAL INFORMATION

SARGENT®

MASTER OPTION LISTING

ASSA ABLOY

USA & Canada Prices Effective June 3, 2019

| Master Option List | | |
|--------------------|---|--|
| Option | Series Used | Description |
| 84 | 7800, 7900, 8200, 7000, 80, 90, 9898, 4870, Padlocks, KP8200, 8200ProfileSer., 8200RF-Actuation, KP88, 88ProfileSer., 88RF-Actuation, KP89, 89ProfileSer., 89RF-Actuation | SARGENT KESO Security Removable Construction Core Cylinder |
| 85 | 11L, 10L, 7L, 6500, 8200, 7800, 7900, 9200, 7000 | Tactile Warning - Abrasive Coating on Inside Lever |
| 86 | 11L, 10L, 7L, 6500, 8200, 7800, 7900, 9200, 7000, 80, 90 | Tactile Warning - Abrasive Coating on Outside Lever |
| 87 | 11L, 10L, 7L, 6500, 8200, 7800, 7900, 9200, 7000, 80, 90 | Tactile Warning - Abrasive Coating on Outside & Inside Lever |
| 91 | 5100, 5800, 10ProfileSer., 8200ProfileSer., 88ProfileSer., 89ProfileSer. | Remote Power |
| 92 | 5100, 5800 | Remote Monitoring |
| 93 | 5100, 5800 | Continuous Alarm |
| 94 | 5100, 5800 | Automatic Re-Arm |
| ABC | 281 | Advanced Backcheck |
| AL | 83, 84, MD84, 85, MD86, WD86, 87, NB87, SP-PP-PR87, 88, 89 | Alarmed (not available with 56 thru 59 options) |
| AV | 7800, 8200, 9200 | Anti-Vandal Pull Trim |
| BC | 80 Series Exit Devices | Boca Code |
| BP | 7800, 8200 | Distributor Bulk Pack Program - Lockbodies |
| BR | 6, 7, 10, T-Zone, 6500, 7800, 7900, 8200, 9200, 7000, 20, 30, 80, 8888, 90, 9898, 9800, 980 Mullions, 470, 480, 4870, 5100, 5800, KP10, ProfileSer., 10LRF-Actuation, KP8200, 8200ProfileSer., 8200RF-Actuation, KP88, 88ProfileSer., 88RF-Actuation, KP89, 89ProfileSer., 89RF-Actuation | SARGENT Bump Resistant Cylinder |
| C- | 1131 | Cover |
| CL | 4000Ser. | Low Ceiling |
| CPC | 7000, 281, 351, 422, 1431, 590, 690, 8300, 8400, 8500, 8600, 8700, 8800, 8900, 9700, 9800, 9900 | Clear Powder Coat over 26D/32D |
| DA | 278, 281, 351, 1431, 268, 269, 351EHT | Delayed Action |
| DG1 | 6, 7, 8X, 10, T-Zone, 6500, 7800, 7900, 8200, 9200, 7000, 20, 30, 80, 8888, 90, | SARGENT DEGREE Key System |
| DG2 | 9898, 480, 4870, 758, 858, Keyswitch, KP10, 10ProfileSer., 10RF-Actuation, | SARGENT DEGREE Key System |
| DG3 | KP8200, 8200ProfileSer., 8200RF-Actuation, KP88, 88ProfileSer., 88RF-Actuation, KP89, 89ProfileSer., 89RF-Actuation | SARGENT DEGREE Key System |
| DM | 10LProfile(G1), 8200 Profile(G1), 80Series Profile(G1) | Forced/Propped Door Harness |
| DX | 7800, 8200 | Deadbolt Monitoring |
| EC | 281, 1331 series | Environmentally friendly ABS plastic cover |
| F1 | KESO Cylinders/Keys | Patented Keso Key System |
| FM | 8700 (E, F Rail only) | 2Pt. Latching, Complies with FEMA 361 |
| FW | 7, 10 | Freewheeling |
| G1 | 10LProfileSer., 10LRF-Actuation, 8200ProfileSer., 8200RF-Actuation, 88/89ProfileSer., 88/89RF-Actuation, | v.G1 Next Generation software |
| GL | 8500, 8800, 8888 | Guarded Latch |
| HC | 8700 (all functions), 8800 (not available with 04, 10, 13, 15), 980 | Hurricane Code |
| HC4 | 8700 Series | Hurricane Resistant |
| IDP | Harmony Series 8200 | Integrated Door Position Switch |
| IS | 7800, 8200, 9200 | Inside Working Trim Sets |
| LB | 7900, 8200, 4870 | ADA Extra Large Thumbturn |
| LC | Less Cylinder All products w/cylinders | Less Cylinder |
| LD | 80 series exits | Less Dogging |
| LX | 8200 | Latchbolt Monitor |
| M- | 9200 | |
| MC | 351, 281, 1431, 422, 351EHT | Closer with Metal Cover |
| NB | 7000, 8400, 12-MD8400, MD8600, WD8600, 8700, 306, 313 Aux Controls | No Bottom Rod |
| OBS | 8200, 7800, 9200 | Open Back Strike |
| OS | 7800, 8200, 9200 | Outside Working Trim Sets |

| Master Option List | | |
|--------------------|--|--|
| Option | Series Used | Description |
| P- | 114, 115, HP series | Engraved Paddles "Push" and "Pull" |
| PL | 80 Series | SARGuide™ Photoluminescent Coating |
| RX | 10, 7900, 8200 | Request to exit or enter switch |
| SC | 6, 6500, 7, 10, T-Zone, 7800, 7900, 8200, 7000, 20, 30, 80, 8888, 90, 470, 480, 4870, 758, 858, KP10, 10ProfileSer., 10RF-Actuation, KP8200, 8200ProfileSer., 8200RF-Actuation, KP88, 88ProfileSer., 88RF-Actuation, KP89, 89ProfileSer., 89RF-Actuation | Schlage "C" Keyway Cylinder - "0" Bitted |
| SE | 6, 6500, 7, 10, T-Zone, 7800, 7900, 8200, 7000, 20, 30, 80, 8888, 90, 470, 480, 4870, 758, KP10, 10ProfileSer., 10RF-Actuation, KP8200, 8200ProfileSer., 8200RF-Actuation, KP88, 88ProfileSer., 88RF-Actuation, KP89, 89ProfileSer., 89RF-Actuation | Schlage "E" Keyway Cylinder - "0" Bitted |
| SF | 7L, 10L, 11L | L Lever to accept Schlage Large Format Interchangeable Core (supplied less core, tailpiece included) |
| SG | 6, 7, 9, 10, T-Zone, 7800, 8200, 9200, 1431, 281, 422, 351, 80, 90, O/H Holders & Stops, 4870, 114/115, KP10, 10ProfileSer., 10RF-Actuation, KP8200, 8200ProfileSer., 8200RF-Actuation, KP88, 88ProfileSer., 88RF-Actuation, KP89, 89ProfileSer., 89RF-Actuation | MicroShield® - an antimicrobial powdercoat finish |
| SL | T-Zone | High Security Lever Attachment |
| SRI | 351, 281, 1431, 268, 278, 269, 422 | Additional Special Rust Inhibitor (SRI) |
| T1 | 7900, 8200, R8200 | Decorative thumbturn; backplate matches rose design chosen |
| T2 | 7900, 8200, R8200 | Decorative square thumbturn; backplate matches rose design chosen |
| T3 | 7900, 8200, R8200 | Decorative cylinder thumbturn; backplate matches rose design chosen |
| TB | 7000, 351, 281, 1431, 278, 422, 1331, 1131, 2727, 2828, 3727, 3828, 8300, 8600, 8500, 8700, 8800, 8900, 9400, 9700, 9800, 9900, 114, 115, 5800, 351EHT, 2408, 2900 | Thru Bolt |
| TL | 80 | SARGuide™ - Illuminated Touchpad |
| | 8200 x WT(escutcheon) | SARGuide™ - Illuminated WT Escutcheon |
| TR | 7800, 8200 | Distributor Bulk Pack Program - Complete Trim Packs |
| WBS | 11L, 10L, 7L, DL, 6L, 8200, 7800, 7900, 9200 | Wrought Box Strike |
| WS | 8500, 8800, & 8900 Series | Windstorm Certified |
| YC | 11L | L or P Lever to accept Yale® 6-pin fixed core cylinder |
| YC7P | 11L | L or P Lever to accept Yale® 7-pin fixed core cylinder |
| YRC | 11L | L or P Lever to accept Yale® 6-pin LFIC |
| YRC7P | 11L | L or P Lever to accept Yale® 7-pin LFIC |

GI-18 GENERAL INFORMATION

SARGENT[®]

PARTNER SERVICES GENERAL INFORMATION

ASSA ABLOY

USA & Canada Prices Effective June 3, 2019

PARTNER SERVICES IN THE UNITED STATES

Business Hours: The Partner Services Team (except Customer Service)
is available: 8:00 AM to 4:30 PM Eastern Standard Time.

Customer Service Hours: 8:00 AM to 6:00 PM (Monday – Thursday)
8:00 AM to 4:30 PM (Friday)

Toll Free Telephone Number: 1-800-727-5477

Order Fax Number: 1- 800-906-6606. **Order email:** usnew.orderentry@assaabloy.com

Contact Phone Numbers: Included is a list of Who's Who for the Partner Services Team. This list includes Team Member's direct extensions and email addresses.

2019 Calendar:

- January 1 (New Years)
- January 21 (Martin Luther King Day)
- February 18 (President's Day)
- April 19 (Good Friday)
- May 27 (Memorial Day)
- July 4 and 5 (4th of July)
- September 2 (Labor Day)
- November 28 and 29 (Thanksgiving)
- December 24 and 25 (Christmas)

SARGENT Website: We offer a full service website www.sargentlock.com. The Partner Services page of the SARGENT website includes templates, instruction sheets, configurable cut sheets, wiring diagrams and our latest product developments. All product information catalogs are also available on this website.

RGA Policy: Please refer to GI-4 of the General Information Section.

WHO'S WHO AT SARGENT

USA & Canada Prices Effective June 3, 2019

CUSTOMER SUPPORT SERVICES

(Order Processing, Customer Service, Keying)

Telephone: 800-727-5477**Director, Customer Support Services- AEHG**

Lynn Higgins

1-5948

Lynn.Higgins@assaabloy.com

Manager, Keying, Order Entry & EBusiness

Bethany Cordeiro

1-4271

Bethany.Cordeiro@assaabloy.com

com

Manager, Customer Services

Susanna Bria

1-5584

Susanna.Bria@assaabloy.com

Order Processing – Edit/Enter Orders**Fax Orders To: 800-906-6606****Email standard orders to: orders.sargent@assaabloy.com****Email turbo orders to: turboorders.sargent@assaabloy.com****Customer Service – Expedites, Returns,
Change Orders, Line Suspensions****Fax: 888-863-5054****Telephone: 800-727-5477****For Customer / Technical Support Services in Canada
Please see page GI-6**

USA & Canada Prices Effective June 3, 2019

Telephone: 800-727-5477 • Fax Orders To: 800-906-6606

Customer Service Team Members
Expedites, Returns, Change Orders, Line Suspensions
Customer Service's Fax: 888-863-5054 • Telephone: 800-727-5477
Email: customerservice.sargent@assaabloy.com

Manager of Customer Service

| | | |
|--------------|--------|----------------------------|
| Susanna Bria | 1-5584 | Susanna.Bria@assaabloy.com |
|--------------|--------|----------------------------|

Customer Support Specialists

(Returns, Expedites, Product Questions, Changes, Suspensions)

Western Region 2, 4 (Southeast & Western)

| | | |
|---|--------|---------------------------------------|
| Luci Muzyk: (A15, A37, A38, A39, & GA Only) | 1-6852 | customerservice.sargent@assaabloy.com |
|---|--------|---------------------------------------|

Northeast Regions 1

| | | |
|---|--------|---------------------------------------|
| Monique Delgado: (A02, A03) & OEM Customers | 1-5713 | customerservice.sargent@assaabloy.com |
|---|--------|---------------------------------------|

Central Region 3, 4

| | | |
|----------------------------------|--------|---------------------------------------|
| Shirley Sotaski: (A27, A28, A43) | 1-5715 | customerservice.sargent@assaabloy.com |
|----------------------------------|--------|---------------------------------------|

Western Region 4 (South)

| | | |
|--------------------------|--------|---------------------------------------|
| Anne Dempster: HI, Arrow | 1-5906 | customerservice.sargent@assaabloy.com |
|--------------------------|--------|---------------------------------------|

Western Region 4

| | | |
|---------------------------------|--------|---------------------------------------|
| Donna McQuarrie: (A01, A44, SC) | 1-5595 | customerservice.sargent@assaabloy.com |
|---------------------------------|--------|---------------------------------------|

NE & Midwest Atlantic Region 1

| | | |
|----------------------------|--------|---------------------------------------|
| Anne Dempster: (A07 & A08) | 1-5906 | customerservice.sargent@assaabloy.com |
|----------------------------|--------|---------------------------------------|

Northern Region 1, Central Region 3, Southeast Region 2

| | | |
|--|--------|--|
| Robin Pascale: (A16, A31, A32) & NC only | 1-5759 | |
|--|--------|--|

Central Region 3

| | | |
|----------------------------|--------|---------------------------------------|
| Joann Sierajko: (A21, A22) | 1-5755 | customerservice.sargent@assaabloy.com |
|----------------------------|--------|---------------------------------------|

International Companies

| | | |
|------------|--------|---------------------------------------|
| Luci Muzyk | 1-6852 | customerservice.sargent@assaabloy.com |
|------------|--------|---------------------------------------|

Customer Exceptions:

Joann Sierajko: All Akron, MidWest Wholesale DBA Banner Solutions

Shirley Sotaski: Builders Hardware & Doors Inc. DesMoines/Cedar Rapids

Anne Dempster: Himmels Hardware & Island Pacific, Doors Inc. Ft Dodge

Robin Pascale: Dugmore & Duncan, Doors Inc. Swaledale/Iowa City

Donna McQuarrie, DH Pace KS & MO only

Luci Muzyk: Doors Inc. Waterloo/Davenport

WHO'S WHO AT SARGENT

USA & Canada Prices Effective June 3, 2019

Telephone: 800-727-5477 • Fax Orders To: 800-906-6606**Master Key System's Support Fax: 888-898-8995****KEY DESIGN TEAM**

| | | |
|--|--------|------------------------------------|
| Birute Gelazauskiene – (Signature) | 1-5786 | Birute.Gelazauskiene@assaabloy.com |
| Lijana Mursko – (Conventional, Keso, Non, 24-Hour) | 1-5558 | Lijana.Mursko@assaabloy.com |
| Romas Sakalauskas – (KESO) | 1-5625 | Romas.Sakalauskas@assaabloy.com |
| Saulius Jovaisa – (Conventional, SFIC) | 1-5722 | Saulius.Jovaisa@assaabloy.com |
| Aurela Dautaj – (Canada Orders, Biting Lists) | 1-5746 | Aurela.Dautaj@assaabloy.com |
| Saulius Pleseckis – Key Edit | 1-5767 | Saulius.Pleseckis@assaabloy.com |

MARKETING**Director of Marketing Communications**

| | | |
|------------|--------|--------------------------|
| Beth Welch | 1-4263 | Beth.Welch@assaabloy.com |
|------------|--------|--------------------------|

Marketing Communications Manager – Electronic Access Control

| | | |
|----------------|--------|------------------------------|
| Rebecca Samuel | 1-4225 | rebecca.samuel@assaabloy.com |
|----------------|--------|------------------------------|

Product Marketing Manager – Decorative Hardware

| | | |
|---------------|--------|-----------------------------|
| Emily Charles | 1-5682 | Emily.Charles@assaabloy.com |
|---------------|--------|-----------------------------|

Marketing Communications Specialist – Mechanical Products

| | | |
|--------------|--------|----------------------------|
| Amy Esposito | 1-5608 | Amy.Esposito@assaabloy.com |
|--------------|--------|----------------------------|

BRAND PROMOTIONS**Director of Business Development**

| | | |
|----------------|--------|------------------------------|
| Dave Higginson | 1-7216 | Dave.Higginson@assaabloy.com |
|----------------|--------|------------------------------|

WHO'S WHO AT SARGENT

USA & Canada Prices Effective June 3, 2019

Telephone: 800-727-5477 • Fax Orders To: 800-906-6606
SALES SUPPORT SERVICES TEAM
Fax: 203-821-5729

Director of Strategic Pricing

| | | |
|-------------------|--------|---------------------------------|
| Woody Sharp | 1-5606 | Woody.Sharp@assaabloy.com |
| Larisa Chavenello | 1-3396 | Larisa.Chavenello@assaabloy.com |
| Rich Hodder | 1-5583 | Richard.Hodder@assaabloy.com |
| Janice Shanley | 1-6823 | Janice.Shanley@assaabloy.com |
| Mamadou Hane | 1-3333 | Mamadou.Hane@assaabloy.com |
| Christine Le | 1-5721 | Christine.Le@assaabloy.com |

TECHNICAL SUPPORT TEAM (Electronics)
Electro-mechanical and Electronic Access Control Products
Direct: 800-810-9473
Email: techsupport.sargent@assaabloy.com

EM Technical Support Team Leader

| | | |
|--------------|--------|----------------------------|
| Gary Jacques | 1-5920 | gary.jacques@assaabloy.com |
|--------------|--------|----------------------------|

EM Specialists (EAC Products)

| | | | |
|--------------------------|-----------------------|--------------|-----------------------------------|
| Ruben Delgado | Stephanie Jorge-Reyes | | |
| Alfred Gutierrez | Nadia Morales | | |
| Joseph Gonzalez | Anthony Ruggiero | 800-810-9473 | techsupport.sargent@assaabloy.com |
| Jacqueline Gonzalez | Greg Stevens | | |
| Valerie Espinal-Castillo | Andrew Yoo | | |

TECHNICAL SUPPORT TEAM (Mechanical)
Mechanical Products 800-727-5477, Option 2
Email: techsupport.sargent@assaabloy.com

Exit Device Specialist

FAX: 203-821-5782

| | | | |
|----------------------|-----------------|---------|-------------------------------|
| <u>Main Contact:</u> | Gloria Dennis | Press 4 | Gloria.Dennis@assaabloy.com |
| <u>Back Up:</u> | Stephen Cibulas | Press 4 | Stephen.Cibulas@assaabloy.com |

Mortise Lock Specialist

FAX: 203-498-5567

| | | | |
|----------------------|--------------|---------|----------------------------|
| <u>Main Contact:</u> | Paul Lichack | Press 3 | Paul.Lichack@assaabloy.com |
| <u>Main Contact:</u> | Tino Bowden | Press 3 | tino.bowden@assaabloy.com |

Cylinders Specialist

FAX: 203-603-5921

| | | | |
|----------------------|--------------|---------|------------------------------|
| <u>Main Contact:</u> | Rob Shanley | Press 5 | Robert.Shanley@assaabloy.com |
| <u>Back Up:</u> | Paul Lichack | Press 5 | Paul.Lichack@assaabloy.com |

Door Closer Specialist

FAX: 704-233-1582

| | | | |
|----------------------|-----------------|---------|--------------------------------|
| <u>Main Contact:</u> | Mike Strickland | Press 7 | mike.strickland@assaabloy.com |
| <u>Back Up:</u> | Sean Medlin | Press 7 | smedlin@nortondoorcontrols.com |

Bored Lock Specialist

FAX: 203-821-5768

| | | | |
|----------------------|----------------|---------|------------------------------|
| <u>Main Contact:</u> | Adam Sigovitch | Press 2 | Adam.Sigovitch@assaabloy.com |
| <u>Back Up:</u> | Rob Shanley | Press 2 | Robert.Shanley@assaabloy.com |

ORDERING AND SARGENT KEY SYSTEMS SECURITY POLICY

USA & Canada Prices Effective June 3, 2019

Order Types:

- Please submit **TURBOSHIP orders, Standard lead time(contract) orders, SPECIAL product orders** on separate order forms (Pages GI-27 – GI-30).
- Please use **TURBOSHIP** order forms for all **TURBOSHIP** orders. If you use your own purchase order forms, please supply the information in the proper SARGENT nomenclature, for your order to be processed without delay. Only products listed in the current **TURBOSHIP** brochure are available for **TURBOSHIP**. Products ordered that are not listed in the current **TURBOSHIP** brochure will automatically be entered at standard factory production lead times.
- Standard **Order Forms** are included in the 2019 Price Book and at www.sargentlock.com (Pages GI-27 – GI-30).
- **TURBO SHIP ORDER FORMS** are available on our website at www.sargentlock.com/turboship.html
- We recommend using **Order Forms** included with this Price Book when placing purchase orders for SARGENT products. The **Order Form** is available for copying prior to placing your order.

Orders with Quotes:

- If you have a **Quote**, please include a copy with the purchase order or reference the **Quote** number on **PAGE 1** of your order. Orders without this information may be delayed or may be subject to a \$100.00 price correction fee if invoiced incorrectly due to this missing information
- If you have a **Quote**, please check the expiration date. If the **Quote** is expired, please contact your DSS Sales rep. to find out how your quote can be re-instated. Orders received with expired **Quotes** may be delayed.
- If you have a **Quote**, please check products listed and packaging on the quote. Orders which do not match the products listed on your **Quote** or do not include all products listed on the **Quote** and do not have packaging (sister company order) information, may be delayed.

SARGENT Key Systems Security Policy:

The purpose of this security policy is to enforce our policies concerning high security, security and restricted keyway product, as well as master key system information. No master key system information or security related product is to be given or sold to anyone other than the facility owner through written correspondence. Verification must be submitted (fax copy will be acceptable) to SARGENT Key Records. The verification must be on the facility's letterhead and signed by a facility authorized systems administrator. SARGENT Key Records does not maintain "Letters of Authorization" on file. Each order must be accompanied by proper authorization. Only after the authorization has been verified will the order be processed for production. This security policy refers to the following:

- Signature systems • Protected keyway systems • Security cylinder systems

Also includes:

- Bitting information (even one bitting, absolutely no top-level master keys)
- Bitting lists (all formats; i.e., hard copy, disc)
- Key blanks and systems components

Please note:

- No orders are to be processed through SARGENT Key Records without proper authorization.

ORDERING TIPS & KEYING
– AUTHORIZATION DOCUMENTATION:

USA & Canada Prices Effective June 3, 2019

- Only orders with appropriate authorization attached will be given priority.
- Requests for systems information without proper authorization from the owner will be denied.
- Requests for information regarding the purchase of any systems support products as listed above will be referred to the local authorized sales agency.
- Refer to the current price lists for additional policies and procedures as they relate to this security policy.

Remember:

The purpose for the establishment of any security system is to provide an increased level of protection for the Facility owner.

Keying - Authorization Documentation:

When submitting purchase orders to SARGENT for processing, please remember that certain cylinder types and/or keyways require additional authorization documentation before the order can be entered.

Purchase orders will be held and questioned if the following keyway/cylinder types do not have the proper authorization documentation submitted with each purchase order or shipment of the following items will be made directly to the end user or their designated agent:

- All Restricted Keyway Cut Keys or Key Blanks;
- All Signature Cut Keys or Key Blanks;
- All XC Restricted Cut Keys or Key Blanks;
- All dimpled KESO keys;
- All computer disks (CD or Floppy) for the Key Wizard Control Software and
- All key system bitting information in either paper or electronic form

Exceptions:

- Standard key blanks and cut keys for the “C”, “H”, “L” and “R” keyway families
- XC key blanks and cut keys for any non-restricted keyway family

Any order or fax request received at SARGENT for any of the above products or information must specify the shipping address of that product or information as the end user of the product or information. If the product is to be shipped to the end user’s authorized agent, a letter authorizing that shipment to an address different than that of the end user must be on file at SARGENT or attached to the order.

If you have any questions regarding authorization, please do not hesitate to contact us or your local representative.

Purchase Order Format

For Comsense and Protech users please **use the Purchase Order Supporting (Detail) Schedule** to place contract orders, NOT the Door Index or Keying Index. Only the Purchase Order Supporting Schedule contains all of the information required, (options, item quantities) to properly furnish you materials.

For all other formats we ask that product of like nature be grouped together with the item quantities, Door Numbers, and keysets listed underneath or with the product. This will allow faster processing of your order.

Ordering Checklist:

Before placing your order, check for the following:

- ✓ Purchase order on company letterhead
- ✓ Purchase order is legible
- ✓ Purchase Order Number
- ✓ Account Number
- ✓ Ship To Address
- ✓ Contact Person for additional information requirements
- ✓ Pricing requirements – Buying Program or Quote
- ✓ TURBOSHIP order - TURBOSHIP order form OR clearly mark on your order form
- ✓ Contract Order (Keyed Lead Sheets attached)
- ✓ Authorization Letter **OR** Pin # (if applicable)
- ✓ Registry Number if Existing Key System or previous SARGENT order number
- ✓ Job Name
- ✓ Quantity
- ✓ Catalog Function
- ✓ Options (if applicable)
- ✓ Trim/Arm
- ✓ Finish (if applicable)
- ✓ Handing (if applicable)
- ✓ Backset & Strike (if applicable)
- ✓ Door thickness (if applicable)
- ✓ Door width & height – Exit Devices
- ✓ Voltage (if applicable)
- ✓ Keysets (if applicable)
- ✓ Door numbers (if applicable)

USA & Canada Prices Effective June 3, 2019

SARGENT Order Lead Sheet Check List

| | | Master Keyed Orders (including SKD type systems) | | None Master Keyed Orders (Random, 1-bitted or None Keyed) | |
|---|--|---|--|--|--------------------------------|
| | | New System | Existing System | | |
| Distributor Name | | Required | Required | Required | |
| PO Number | | Required | Required | Required | |
| Job Name, Address | | Required | Required | Required | |
| Section # | Description | | | | |
| 1 | System Status | Required | Required | Not required | |
| 2 | System Design | Required | Not required | Not required | |
| 3 | System Type | Required | Not required | Not required | |
| 4 | Key way | Required | Not required | If applicable | |
| 5. AUTHORIZATION (depends on type and feature of system) | SARGENT Standard | i. <u>Conventional</u> Cyl. Features available: 21, 22***, 50, 51***, 63 | Not required | Not required | Not required |
| | | ii. <u>XC (11 Prefix)</u> Cyl. Features available: 21 | Not required | Not required | Not required |
| | | iii. <u>Restricted Keyways</u> (A, B, G, K, N, V) Cyl. Features available: 10, 11, 21, 22***, 50, 51***, 63 | Has to be pre-approved by SARGENT Keying Department** | LOA or Ship Directly to End User | Same as Master keyed Orders |
| | | iiii. <u>Signature (10 Prefix)</u> Cyl. Features available: 21, 63 | Signature Agreement* with properly filled information | PIN Code or LOA with Authorized person Signature or Ship directly to End User | Same as Master keyed Orders |
| | SARGENT KESO Cyl. Features available: F1, 82, 83 | | KESO Signature Card* | KESO Forms* with Authorized person signature or Ship Directly to End User | Not Available |
| | SARGENT Degree Cyl. Features available: 21, 63 | | SARGENT Degree SID * with properly filled information | LOA and/or Security Codes or Ship Directly to End User | Not Available |
| | SARGENT SFIC | i. <u>Regular keyways: 4A</u> See Price Book for available competitors keyways Cyl. Features available: 11, 73 | Not required | Not required | Not required |
| | | ii. <u>Restricted Keyways: 4B</u> Cyl. Features available: 11, 73 | Has to be pre-approved by SARGENT Keying Department** | LOA or Ship Directly to End User | Same as Master keyed Orders |
| 6 | Key Quantity | Required | Required | Required | |
| 7 | Cylinder Features <i>See General Section of Price Book for valid prefix combinations!</i> | If applicable | If applicable | If applicable | |
| 8 | Stamping Requirements | If not selected default stamping will be used | | | |
| 9 | Cross Keying | Required (If applicable) | Required (If applicable) | Not required | |
| 10 | Packing and Marking change keys | Required | Required | Required | |
| 11 - 16 | Shipping instructions | Required | Required | Required | |
| 17 | Bitting List | If applicable | If applicable | If applicable | |
| 18 | Contact | Required | Required | Required | |

* - Can be found in SARGENT Price Book, General Information section or please contact Key Records (fax: 888-898-8995)

** - Prior order is placed all necessary information has to submit to SARGENT Key Records (fax: 888-898-8995) by DSS.

*** - 22 and 51 are only available for existing systems. 11&63, 10&11 are not valid combinations together.

SARGENT®

ASSA ABLOY

USA & Canada Prices Effective June 3, 2019

| SARGENT KEYED ORDER LEADSHEET | |
|--|--|
| THIS ORDER ONLY (Section 10 - 18) | |
| | P.O. # _____ |
| 10) PACKING INSTRUCTIONS FOR CHANGE KEYS | |
| <input type="checkbox"/> Pack Change Keys With Locks (Standard) <input type="checkbox"/> Pack Change Keys separately - See Price Book | |
| 11) SHIPPING INSTRUCTIONS FOR CHANGE KEYS | |
| Ship Change Keys To: _____ _____ Attention: _____ | |
| 12) SHIPPING INSTRUCTIONS FOR MASTER KEYS | |
| Ship Master Keys To: _____ _____ Attention: _____ | |
| 13) SHIPPING INSTRUCTIONS FOR KEY BLANKS | |
| Ship Keyblanks To: _____ _____ Attention: _____ | |
| 14) SHIPPING INSTRUCTIONS FOR CORES | |
| Ship Cores To: _____ _____ Attention: _____ | |
| 15) SHIPPING INSTRUCTIONS FOR KEY WIZARD SOFTWARE | |
| Ship Keywizard Software To: _____ _____ Attention: _____ | |
| <input type="checkbox"/> Registration Form Att'd (Required) | |
| 16) SHIPPING INSTRUCTIONS FOR CONSTRUCTION KEYS | |
| Ship Construction Keys To: _____ _____ Attention: _____ | |
| 17) SHIPPING INSTRUCTIONS FOR BITTING LIST | |
| <input type="checkbox"/> Only Keysets that are ordered with product on this PO (N/C) <input type="checkbox"/> Expanded Bitting List (Please provide requirements) <input type="checkbox"/> Provide on Disc <input type="checkbox"/> Provide on Paper Ship to: _____ _____ Attn: _____ | KEYWIZARD DOWNLOAD DISC <input type="checkbox"/> Keywizard Download File on Disc Ship to: _____ _____ Attn: _____ |
| <i>Note: Please see Price Book page CK-4 for prices and additional information regarding above items</i> | |
| Expanded Bitting List requirements: | |
| _____ _____ _____ | |
| 18) CONTACT INFORMATION - Name of individual in your organization who is knowledgeable about this project should any clarification be necessary. | |
| _____ Name: _____ _____ Phone #: _____ Fax #: _____ _____ Email: _____ | |

**SARGENT *Signature* Series
Code Pattern Registration Form**

100 Sargent Drive New Haven, CT 06511 Phone 800-727-5477 Fax 888-898-8995

Section A Distributor Information

(1) Date:

(2) Distributor Name:

(3) Account Number:

(4) City:

(5) State:

(6) Zip Code:

(7) Contact Name:

(8) Phone:

(9) Fax:

Section B Facility Information:

(10) Facility Name:

(11) Building Name:

(12) Address:

(13) City:

(14) State:

(15) Zip Code:

(16) Area Responsible for Key System:

And Names
Of Authorizing
Individuals

Title:

Title:

Mailing Address:

City:

State:

Zip:

Phone:

Fax:

Section C: System Specifications:

Existing System

New System

Cylinder Quantity:

Existing Registry Number:

Requested Keyway:

System Level:

Construction Keying

Removable Core

Hotel Mky

Section C: Area of Exclusivity:

State

Adjacent States

Additional States:

Final Approval and Assignment by SARGENT

Factory Use Only:

Keyway Family: _____

Signature Code _____ PIN Code _____ Zip: _____

Alternate Code _____



SARGENT®

ASSA ABLOY

USA & Canada Prices Effective June 3, 2019

| AUTHORIZED SIGNATURE FORM SARGENT KESO SECURITY SYSTEM | | | | | | | | | | |
|--|---|-----------------------------|--|----------|--|--------------|--|----------|--|--|
| Register No: <input type="checkbox"/> Keso F1 <input type="checkbox"/> Keso (Standard) | <table border="1" style="width: 100%; border-collapse: collapse;"> <tr> <td style="width: 50%;">Job:</td> <td></td> </tr> <tr> <td>Address:</td> <td></td> </tr> <tr> <td>Distributor:</td> <td></td> </tr> <tr> <td>Address:</td> <td></td> </tr> </table> | Job: | | Address: | | Distributor: | | Address: | | |
| Job: | | | | | | | | | | |
| Address: | | | | | | | | | | |
| Distributor: | | | | | | | | | | |
| Address: | | | | | | | | | | |
| PERSON(S) AUTHORIZED TO ORDER ADDITIONAL LOCKSETS, CYLINDERS OR KEYS | | | | | | | | | | |
| | | | | | | | | | | |
| Signature | Title | Name (please type or print) | | | | | | | | |
| | | | | | | | | | | |
| Signature | Title | Name (please type or print) | | | | | | | | |
| | | | | | | | | | | |
| Signature | Title | Name (please type or print) | | | | | | | | |
| | | | | | | | | | | |
| Company Affiliation | | | | | | | | | | |
| | | | | | | | | | | |
| Address | | | | | | | | | | |
| | | | | | | | | | | |
| SARGENT Manufacturing Company • 100 Sargent Drive • P.O. Box 9725 • New Haven, CT 06536-0915 Phone: 800-727-5477 • Fax: 888-863-5054 • Website: www.sargentlock.com SARGENT of Canada • Phone: 905-940-2040 • Fax: 905-940-3242 • Website: www.sargentcanada.ca | | | | | | | | | | |
| An ASSA ABLOY Group company | ASSA ABLOY | | | | | | | | | |

USA & Canada Prices Effective June 3, 2019

**AUTHORIZATION FORM
SARGENT KESO SECURITY SYSTEM**



Keso F1 Keso (*Standard*)

| | |
|-------------------------------|--|
| Date: | |
| Distributor Purchase Order No | |

| | | | | | |
|-------------------|--------|------|--|--|--|
| TO | | | | | |
| Distributor Name: | | | | | |
| Address: | | | | | |
| City: | State: | Zip: | | | |

Following to be completed by owner of system

| | | | | | |
|---|--------|------|--|--|--|
| FROM | | | | | |
| Name: | | | | | |
| Company: | | | | | |
| Address: | | | | | |
| City: | State: | Zip: | | | |
| Printed Name | | | | | |
| Authorized Signature <i>(Must match signature on file)</i> | | | | | |

PLEASE RETURN SIGNED FORM AND ORDER TO DISTRIBUTOR. DO NOT MAIL DIRECT TO SARGENT MANUFACTURING COMPANY.

THIS IS TO AUTHORIZE SARGENT MANUFACTURING COMPANY TO ACCEPT YOUR ORDER FOR LOCKSETS OR CYLINDERS KEYED TO SYSTEM ESTABLISHED FOR:

| | | | | | |
|-----------|--------|------|--|--|--|
| Job Name: | | | | | |
| Company: | | | | | |
| Address: | | | | | |
| City: | State: | Zip: | | | |

SARGENT Manufacturing Company •100 Sargent Drive •P.O. Box 9725 •New Haven, CT 06536-0915
Phone: 800-727-5477 •Fax: 888-863-5054 •Website: www.sargentlock.com
SARGENT of Canada •Phone: 905-940-2040 •Fax: 905-940-3242 •Website: www.sargentcanada.ca

An ASSA ABLOY Group company

ASSA ABLOY

SARGENT

ASSA ABLOY

USA & Canada Prices Effective June 3, 2019

**24 HOUR KEY ORDER
SARGENT KESO SECURITY SYSTEM**



Keso F1 Keso (Standard)

For internal use only, do not write in spaces below

| | |
|-------------------|--|
| Territory: | |
| Order No: | |
| Customer Code No: | |

| Invoice To | | | |
|-------------------|--------------------------------------|---------------------------------------|--|
| Ship To: | <input type="checkbox"/> Distributor | <input type="checkbox"/> System Owner | |
| Distributor Name: | | | |
| Address: | | | |
| City: | State: | Zip: | |

Following to be completed by owner of system

| System Owner | | | |
|--|--------|------|--|
| Attention: | | | |
| Company: | | | |
| Address: | | | |
| City: | State: | Zip: | |
| Owner Order No: | Date: | | |
| Printed Name | | | |
| Authorized Signature (Must match signature on file) | | | |

| Quantity of Keys | Key Numbered as Stamped on Key (i.e. A1234 B1234) (Number must be specified) (Use one line per key change) | Other Information |
|------------------|--|-------------------|
| | | |
| | | |
| | | |
| | | |
| | | |
| | | |
| | | |

*For next day shipping orders must be for less than 25 keys and be received by 10:00 am EST

SARGENT Manufacturing Company •100 Sargent Drive •P.O. Box 9725 •New Haven, CT 06536-0915
Phone: 800-727-5477 •Fax: 888-863-5054 •Website: www.sargentlock.com
SARGENT of Canada •Phone: 905-940-2040 •Fax: 905-940-3242 •Website: www.sargentcanada.ca

An ASSA ABLOY Group company

ASSA ABLOY

USA & Canada Prices Effective June 3, 2019



SARGENT Key Wizard™ Registration Form

***Note: Mandatory information (please type or print clearly) required to pre-register the software and generate the software license number. Please attach this form to your Purchase Order and fax both to SARGENT Customer Service: 1-800-906-6606**

For Use by End User

***Account Name:**

***Contact Name:**

***Address 1:**

Address 2:

| | | | |
|---------------|----------------|-------------------|------------------|
| *City: | *State: | *Zip Code: | *Country: |
|---------------|----------------|-------------------|------------------|

***Phone #:**

Fax #:

***E-mail:**

| | | | | |
|--|---|--|--|---|
| <input type="checkbox"/> Standalone Version SW-600101 | <input type="checkbox"/> Network Version SW-600301 | <input type="checkbox"/> Demo Version SW-200001 | <input type="checkbox"/> Yearly Maintenance SW-500001 | <input type="checkbox"/> Network Upgrade SW-600401 |
|--|---|--|--|---|

***Today's Date:**
March 5, 2009

***Order Written By:**

***Order Writer's Phone Number: / Order Writer's Fax Number:**

***Purchase Order Number:**

Misc. Instructions:

For Use by Distributor

Distributor Name:

Distributor Order Number:

For Use By SARGENT

SARGENT Customer Order #:

SARGENT Internal Order #:

Technical Questions on Wizard™ Software: 800-610-1706

SARGENT[®]

ASSA ABLOY

USA & Canada Prices Effective June 3, 2019

Degree™ System Information Document

System: _____ DG1 _____ DG2 / DG3

NOTE: System Information Document required for all new systems; see reverse for additional document requirements.

Facility Name: _____

Mailing Address: _____

Shipping Address: _____

City: _____ State: _____

City: _____ State: _____

Zip Code: _____

Zip Code: _____

Phone: (_____) _____

Fax: (_____) _____

E-Mail: _____

By: _____
 (Print Name, Primary Systems Administrator) (Title) (Authorized Signatures)

I understand that if any of the authorized representatives of this Facility (as set out below) are removed from their duties for any reason whatsoever, it is my responsibility to notify Sargent Key Records Department, in writing, of their release and the names of their replacements.

Date: _____

| Authorized Facility Representatives (Printed Name) | (Title) | (Authorized Signatures) |
|---|---------|-------------------------|
| _____ | _____ | _____ |
| _____ | _____ | _____ |
| _____ | _____ | _____ |

Please attach any additional.

_____ (Signature or Initial by System Administrator Only)

"OPT-OUT" Option (System Type DG2 & DG3 Only): By selecting this option I elect not to use the sequentially numbered registrations certificates and agree to substitute them with a Letter of Authorization.

Degree DG1 Required Administrative Documents:

- **Mandatory:** all new systems will require a completed System Information Document (orders can not be entered without this document). The fully executed original document will be kept on file at Sargent Manufacturing.
- Subsequent order requirement. A letter of authorization will be required if the product is shipped to an address other than what's recorded on the System Administration Document, and/or if the address on the purchase order is different than what is listed on the System Information Document.

Degree DG2 & DG3 Required Administrative Documents:

- **Mandatory:** all new systems will require a completed System Information Document (orders can not be entered without this document). The fully executed original document will be kept on file at Sargent Manufacturing.
- Subsequent order requirement: A specific randomized security code will be required for each order unless "Opt-Out" has been authorized by the systems administrator.
- If the "Opt Out" option is ***NOT*** selected
 - A correct system specific (randomized) security code must be included with each subsequent order.
 - Security codes are specific to each order.
 - If the shipping address is other than the one listed on the System Information Document, a Letter of Authorization signed by one of the recorded authorized representatives of the facility is required.
 - Letter of Authorization must contain the same shipping address that appears on the customer's Purchase Order.
 - Letters of Authorization will not be kept on file at factory.
 - Without the proper security code, Letter of Authorization, or if the shipping address is other than what's listed on the System Information Document, the order cannot be processed.
- If the System Administrator elects not to use security codes as part of the authorization process, the "Opt Out" option can be authorized by the system administrator.
 - If the "Opt Out" option is ***S*** selected
 - A system-specific security code is not required.
 - Letter of Authorization must be signed by one of the facility's authorized representatives. If the shipping address is other than the one listed on the System Information Document, a Letter of Authorization will be required.
 - Letter of Authorization must contain the same shipping address that appears on the customer's Purchase Order.
 - Letters of Authorization will not be kept on file at factory.

CYLINDERS AND KEYING

| | |
|---|-------|
| How to Order/Key Control System Types | CK-1 |
| Key Control System Types/ Old Style/LFIC/SFIC Temporary Construction Cores | CK-2 |
| Keying Charges..... | CK-3 |
| Key Charts/Key Wizard Software..... | CK-4 |
| Mortise & Rim Cylinders..... | CK-5 |
| Cylinders & Accessories | CK-6 |
| Bored Lock Cylinder & Parts..... | CK-7 |
| XC Series | CK-8 |
| XC Series | CK-9 |
| SARGENT Large Format Interchangeable Core Cylinders & Old Style Removable Core Cylinders | CK-10 |
| SARGENT XC - Large Format Interchangeable Core Cylinders..... | CK-11 |
| Small Format Interchangeable Core | CK-12 |
| XC - Small Format Interchangeable Core..... | CK-13 |
| Keying Kits, Tools, Gauges, Components | CK-14 |
| Keyblanks..... | CK-15 |
| Keyblanks..... | CK-16 |
| SARGENT Cut Keys/Competitor Keyways | CK-17 |
| KESO F1 Security System Options | CK-18 |
| KESO F1 Security System Cylinders..... | CK-19 |
| KESO F1 Security System Cylinders/Padlocks | CK-20 |
| KESO F1 Security System UL Listed Cylinders/Cam/Padlocks | CK-21 |
| KESO F1 Security System Cylinders Guarantee | CK-22 |
| KESO Security System Options..... | CK-23 |
| KESO Security System Cylinders | CK-24 |
| KESO Security System Cylinders/Padlocks..... | CK-25 |
| KESO Security System UL Listed Cylinders/Cams/Padlocks | CK-26 |
| KESO Security Systems Cylinders Guarantee | CK-27 |
| Signature Series Cylinders & Keying | CK-28 |
| Signature Series Removable Core..... | CK-29 |
| Signature Series Mortise & Rim Cylinders..... | CK-30 |
| Signature Series Bored Lock Cylinders & Parts | CK-31 |
| Degree Keying Chares..... | CK-32 |
| Degree DG1 Cylinders | CK-33 |
| Degree DG1 LFIC and DG2 Cylinders..... | CK-34 |
| Degree DG2 Cylinders and LFIC Cylinders | CK-35 |
| Degree DG3 Clinders..... | CK-36 |
| Degree DG3 LFIC Cylinders | CK-37 |
| Degree DG3 Degree Pins and Parts..... | CK-38 |

How to Order

| Step | Description | Example |
|----------------|--|------------------------------------|
| Quantity | Each | 1 Ea |
| Option | Consult catalog for options available | 1 Ea. 63- |
| Product Series | Consult catalog for applicable product | 1 Ea. 63-8205 LNL |
| Finish | Consult catalog for finishes available | 1 Ea. 63-8205 LNL US26D |
| Keying | DHI keying nomenclature | 1 Ea. 63-8205 LNL US26D AA1 |

To establish a new factory master key system or to add to an existing factory master key system please use the NEW ORDERING INFORMATION LEAD SHEET.

For all master keyed systems of a level 5 or above, please consult factory before ordering for information on how to order.

Key Control System Types

| Type | Description | Option |
|--|--|--|
| Stock Keyway (LA) | LA keyway will be provided on non-masterkeyed order if no keyway is provided. | - |
| Standard | Keyways in general use for key systems. | - |
| Restricted (Not Published) | Keyways tightly controlled by the factory, letter of authorization required from end user for keys & cylinders, and prior approval from the SARGENT Security Systems Manager before establishing a new system. | - |
| Large Format IC Core (R Series Standard-for New Systems) | System allows for increased security through quick changing of cylinder into reserve or into another lock. System can be used with mortise locks, bored locks, auxiliary deadlocks, padlocks and exit devices. | 63 64 Construction Core |
| Small Format Interchangeable Core | System allows for increased security through quick changing of core into cylinder housing or into another lock. System can be used with mortise locks, bored locks, auxiliary locks, and exit devices. Available in SARGENT 4A & 4B keyway family & existing competitor keyway families. | 72 Construction 73 (6-Pin) 73-7P (7-Pin) |
| XC | Patented product that cannot be copied and supplied by others. Provides an intermediate level of control by ensuring that the keyblanks are not readily available in the market. Offered in many of SARGENT's standard keyways and is readily integrated as a cost-effective means of achieving higher security key control in an existing key system. Available in SARGENT standard or 7 Pin Small Format (4A and restricted keyway 4B) Interchangeable Core cylinders and Sargent Large Format Interchangeable Core. | 11 |
| Signature | Signature codes tightly controlled by the factory. Pin # or explicit letter of authorization required from the end user for keys & cylinders. New code assignments require form H759 "Code Pattern Registration Form" to establish Signature Code and keyway assignments. Available with construction keying and removable core options (as additions). When Signature and Standard keys are used on the same system, miscellaneous charges and substitution prices that apply to Signature will apply to Standard. | 10 |
| KESO | KESO codes tightly controlled by the factory. End users signature required for keys & cylinders. Please contact factory for approval BEFORE establishing any new KESO system. All keying and key cutting performed in a factory secure area. | 82 83 Removable Core 84 Construction Core |
| KESO F1 | KESO F1 Series of cylinders incorporates the same time proven KESO product line and includes advanced Patented features. These features to both cylinder and key are designed to be used in new Patented cylinders and are compatible with existing KESO key systems. KESO F1 codes tightly controlled by the factory. End users signature required for keys & cylinders. All keying and key cutting performed in a factory secure area. | F1-82 F1-83 Rem. Core 84 Construction Core |
| Bump Resistant | Patent Pending bump resistant cylinders. These cylinders employ especially engineered patent pending pinning components designed to resist bumping while maintaining the cylinder's strength. Not available with 10, 22, 30, 60, 63, 64, 70, 72, 73, 737P, KESO, SC, SE options. | BR |

CK-2 CYLINDER & KEYING

SARGENT[®]
ASSA ABLOY

USA & Canada Prices Effective June 3, 2019

| Key Control System Type | Types Description | Option |
|-------------------------|---|--------|
| Degree DG1 | Patented Key Control features a utility patented keyway and is constructed to provide DG1 protection against bumping for mortise, rim and component fixed cylinders. These cylinders easily retrofit into existing hardware. | DG1 |
| Degree DG2 | Patented Key Control Integrated with Security Protection combines a utility patented keyway and patented side bar locking with unique angled bottom pins that provide end users with geographical exclusivity. Cylinders are constructed to provide protection against bumping and picking. Because of its superior key control, patent protection until 2027, and physical strength, we recommend SARGENT DG2 products to be used in conjunction with the DG3 for new installations or when retrofitting systems, including large format interchangeable core systems. | DG2 |
| Degree DG3 | High Security with Patented Key Control is our premier brand technology. Degree DG3 combines a utility patented keyway and side bar locking with unique angled bottom pins that provide end users with geographical exclusivity. These cylinders have earned a UL437 Listing, the ANSI/BHMA A156.5 Grade 1 certification, and are classified as high security because of their superior resistance to physical attack and protection against unauthorized key duplication. Because of its superior key control, patent protection until 2027, and physical strength, we recommend SARGENT DG3 products for new installations or when retrofitting systems, including large format interchangeable core systems. | DG3 |

| OLD STYLE REMOVABLE TEMPORARY CONSTRUCTION CORES | Price/Brass Core |
|--|------------------|
| (52-) | \$78.00 |

| Number | Description | Price |
|---------|--|--------|
| 252CMK | Old Style Temporary Construction Master Key - 5 pin (52-) | \$9.00 |
| 252CTL | Old Style Temporary Construction Control Key - 5 pin (52-) | |
| 6252CMK | Old Style Temporary Construction Master Key - 6 pin (52-) | |
| 6252CTL | Old Style Temporary Construction Control Key - 6 pin (52-) | |

| LFIC/SFIC TEMPORARY CONSTRUCTION CORE | Price/Brass Core |
|---------------------------------------|------------------|
| (64-, 1164-, DG1, 2, 3, 64-) | \$77.00 |
| (72- and 11-72-) | \$69.00 |

HOW TO RETURN ABOVE CONSTRUCTION CORE

The full invoice must be paid according to SARGENT's standard terms. The brass construction cores, 6-construction day keys, and 1-control key will be packed together and will ship with the order, unless otherwise specified

Contact your Customer Service Representative for a Returned Goods Authorization. Provide the factory order number and year of the original order. Credit is issued for all cores returned in good operating condition at the time of the original order. Applicable discounts to the original unit are applied to the returned core.

| Number | Description | Price |
|----------|---|--------|
| 6251CMK | Temporary Construction Removable Core Master Key - 6 pin used with 64-, 11-64-, DG1-64, DG2-64, and DG3-64 | \$9.00 |
| 6251CTL | Temporary Construction Removable Core Control Key - 6 pin used with 64-, 11-64-, DG1-64, DG2-64, and DG3-64 | |
| 6282BCMK | Construction Interchangeable Core Master Key - 6 pin used with 72- | |
| 6254BCTL | Construction Interchangeable Core Control Key - 6 pin used with 72- | |
| 7282BCMK | Construction Interchangeable Core Master Key - 7 pin used with 11-72- | |
| 7254BCTL | Construction Interchangeable Core Control Key - 7 pin used with 11-72- | |

Note: The below applies to Standard Key Systems.
 For XC Series refer to CK-8 .
 For Large Format Interchangeable Core refer to CK-12
 For Large Format XC Interchangeable Core refer to CK-13
 For Small Format Interchangeable Core refer to CK-12
 For Small Format XC Interchangeable Core refer to CK-13
 For KESO F1 refer to page CK-18 .
 For KESO refer to page CK-23 .
 For Signature refer to page CK-28 .
 For Degree refer to page CK-32
 SARGENT keyed orders should include Keying Lead Sheet.

| Keying Charges & Substitutions | Price |
|--|-----------------------------------|
| Cylinder Service Fee (applies to cylinders and cores <u>not</u> being installed in ASSA ABLOY products) | Consult Factory |
| *Masterkeying or Higher level of keying, any quantity | |
| Masterkeying or Higher level of keying, any quantity, cylinders only | Add \$16.00 /cyl. |
| *Construction Masterkeying with lockset or exit devices (21-, 22-) | |
| Construction Masterkeying with cylinders only (21-, 22-) | |
| Extra Keys (Cylinders are packed standard with 2 change keys each) | |
| For each extra key ordered with locksets, exit devices or cylinders | \$5.00 /key |
| For keys packed separately (Indicate appropriate "ship to" address on keying cover sheet) | Add \$4.00 /cyl. |
| Key Marking | |
| "Do Not Duplicate" or other stamps on file at SARGENT | No Addition |
| Where new special stamp is required e.g., "State of Alaska - Do Not Duplicate" Extra lead time required | Add \$840.00 /die |
| Keys stamped from this special die on first only | Add \$4.00 /key |
| Visual Key Control | |
| Stamping of biting numbers on Change/Day keys standard | N/C |
| Stamping of keyset number and file number on Master keys standard | N/C |
| Stamping of cylinder plug and/or two keys with industry standard alpha numeric keyset symbol | Add \$8.00 /cyl. |
| Each additional key | \$1.00 /key |
| Concealed stamping code (Keyset Symbol) on bored, mortise or rim cylinder slide | Add \$8.00 /cyl. |
| Concealed stamping of 6300/10-6300 and old style Cores slide | Add \$8.00 /cyl. |
| Note: Not available with and XC plugs/bodies or signature plugs | |
| Delete SARGENT Logo or delete biting or key set cylinder and or keys (Consult factory for additional cost and leadtime) | |
| *To delete keyway from key per keyway | \$4.00 / key |
| **To delete logo from cylinder or key - Specify which or both | \$4.00 /cyl. or key |
| To delete biting and key set from keys | \$4.00 per key plus set up charge |
| *Set-up charge to delete keyway from key per keyway per order | \$103.00 |
| **Set-up charge to delete logo from cylinder or key | \$103.00 |
| Note: Not available with SFIC, XC, KESO, & Degree | |
| All orders will continue to be handled as a "special" when ordered. Discounts do not apply. | |
| SARGENT Restricted Keyway Family (A, B, G, K, N, V) 6 Pin, (4B) Small Format Interchangeable Core 7Pin | |
| Locksets, cylinders and cores with restricted sections | Add \$7.00 /cyl. |
| Cylinder barrels for restricted keyways | Add \$7.00 /bar. |

NOTES: All orders for restricted keyblanks, barrels, or product containing cylinders that have a restricted keyway must include a letter of authorization or a copy of purchase order from the end user. Prior authorization from SARGENT key systems is required before establishing a new key system that requires a restricted keyway. Contact SARGENT key records to determine size of biting list. U&R keyways available 1 bitted.

Two (2) cut change keys are provided per lockset or cylinder at no charge. Keyblanks cannot be substituted for cut keys. Double cylinder lockset when keyed alike on both sides receives 2 keys per lock.

CK-4 CYLINDERS & KEYING

SARGENT®

KEY CHARTS/KEY WIZARD

ASSA ABLOY

USA & Canada Prices Effective June 3, 2019

| # Bittings | Paper | Disc | Keywizard CD | Disc Price | Keywizard CD Price | Paper Price |
|------------|-------|------|--------------|------------|--------------------|-------------|
| 1-50 | KC1 | KCD1 | DLKW1 | \$210.00 | \$285.00 | \$360.00 |
| 51-200 | KC2 | KCD2 | DLKW2 | \$321.00 | \$396.00 | \$471.00 |
| 201-1000 | KC3 | KCD3 | DLKW3 | \$430.00 | \$505.00 | \$580.00 |
| 1001-3000 | KC4 | KCD4 | DLKW4 | \$542.00 | \$617.00 | \$692.00 |
| 3001-6000 | KC5 | KCD5 | DLKW5 | \$627.00 | \$702.00 | \$777.00 |
| 6001-9000 | KC6 | KCD6 | DLKW6 | \$941.00 | \$1,016.00 | \$1,091.00 |
| Over 9000 | KC7 | KCD7 | DLKW7 | | Consult Factory | |

Note: Bitting Lists (a.k.a. Keycharts) requested for keysets ordered **with** factory keyed product for either a new or existing system will be provided at no charge, except for Keywizard CD DLKW1 thru DLKW7

- Additional Bittings or P.O.'s for Bitting Lists Only – **EXISTING MASTER KEY GROUPS**
Up to 10 **total** for keysets tied to **existing** master key groups will be provided at no charge
11 or more bittings will be charged per above chart
- Additional Bittings or P.O.'s for Bitting Lists Only – **NEW MASTER KEY GROUPS**
Regardless of the quantity being requested, will be charged per above chart

These prices are for a hierarchial Master Key system with no cross-keying of selected keys.

For special requirements or for systems prior to 1997, consult factory for a quote.

An owner's letter of authorization must be attached to all purchase orders for additions to existing systems.

SARGENT is not liable for cylinders pinned incorrectly in the field.

| Key Wizard Software | | Price |
|---------------------|---|------------|
| Catalog # | Description | |
| KW-SS1 | Single license version | \$1,217.00 |
| KW-SSN1 | Network version | \$1,430.00 |
| KW-DEMO1 | Demonstration version | \$34.00 |
| UP-KW-SSN1 | Keywizard upgrade from Single Site Version to Network Version** | \$735.00 |

** Please consult factory for the availability of existing systems for use with Key Wizard products.

Note: First year of maintenance and technical support is included on ALL Key Wizard products

See catalog for system requirements

Registration form required prior to order acceptance

Contact SARGENT key records to determine size of bitting list

USA & Canada Prices Effective June 3, 2019

Note: Assembled Mortise & Rim cylinders include #97 Rosette are available in US3, 4, 9, 10, 10B, 10BE, 10BL, 14, 15, 20D, 32, 32D, BSP, and WSP finishes. Cylinder plugs/barrels will be in either US4 or 15. Specify finish when ordering.
 Note: 6-Pin standard; 7-Pin available in #34 and size 42 and larger. Specify "7-Pin" when 7 Pin cylinders are needed and provide keying details.

| Rim & Mortise Cylinder Numbers | Specify Finish/Price |
|--|----------------------|
| 34 (Rim), 41, 42, 43, 44, 46 (Mortise) | \$89.00 |
| 48, 50, 52, 54 | \$130.00 |
| 56 | \$319.00 |

Note: Optional Cylinder Rosette: 1KB-1, 1KB-2, 1KB-3 are to be ordered and charged separately. Consult individual product catalogs for size.

| Mortise Cylinders with following Suffix Cam No. | | |
|---|--|-------------|
| 101* | Adams Rite 1850, 4700 | |
| 105 | Short Cams I/S 78/82 (16 & 92) functions | |
| 106* | Schlage L | No Addition |
| 112 | "Open" Misc. – Wide Straight Cam | |
| 113* | 4370 Key Switch Cam | |
| 115 | SARGENT Hotel (50-) Cam – for 50-40 Series Cylinders | |

*For removable core cams, see CK-10 .

| Hotel Type Mortise Cylinders – Consult Factory for existing system compatibility | Specify Finish/Price |
|--|----------------------|
| 50-42, 50-43, 50-44 Hotel Cylinder (7850, 8250 only) | \$118.00 |

| Mortise Cylinders, Exposed Barrel Only | Specify Finish/Price |
|---|----------------------|
| 78-41 Thru 78-43 (only available in Std, 10-, 21-, and 22- options) | \$118.00 |

| Mortise Cyl. Plugs | 6-Pin US4 & 15 Finish | |
|--------------------|-----------------------|---------|
| Plug No. | Cylinder Size | Price |
| 13-0401 | 41 | |
| 13-0402 | 42 | |
| 13-0403 | 43 | \$29.65 |
| 13-0404 | 44 | |
| 13-0405 | 46 | |
| 13-0406 | 48 | |
| 13-0407 | 50 | |
| 13-0408 | 52 | \$44.49 |
| 13-0409 | 54 | |
| 13-0474 | 56 | |

| Mortise Cyl. Bodies w/slide | Specify Finish | |
|-----------------------------|----------------|---------|
| Cyl. Body No. | Cylinder Size | Price |
| 13-2005 | 41 | |
| 13-2006 | 42 | |
| 13-2007 | 43 | \$44.04 |
| 13-2008 | 44 | |
| 13-2009 | 46 | |
| 13-2010 | 48 | |
| 13-2011 | 50 | |
| 13-2012 | 52 | \$63.48 |
| 13-2013 | 54 | |
| 13-2382 | 56 | |

| Slide Only – for Mortise & Rim Cylinders (100/pack) | | |
|---|---|------------|
| | | Price/Pack |
| 13-0779 | 6-pin made before 5/08 | \$39.46 |
| 13-0780 | 7-pin made before 5/08 | \$49.32 |
| 13-1341 | 6-Pin Slide for 6300 made after 4/06 w/o box logo. Also on rim/mortise cylinders after 6/08 | \$39.46 |
| 13-1797 | 7-Pin Slide made after 6/08 | \$77.67 |

| Mortise Cams | | |
|--------------|---|---------|
| Part # | Minimum Quantity 25 ea. | Price |
| 13-0097 | "Open" Misc. Wide Straight Cam | |
| 13-0664 | Standard | \$4.91 |
| 13-0665 | Short Cam – I/S 78/82 (16 & 92) Functions | |
| * 13-0512 | Adams Rite (1850, 4700) | |
| * 13-0921 | For 4370 Key Switch Coverleaf Cam | \$7.35 |
| 13-2045 | SARGENT Hotel (50-) Cam for 40 Series Cyls. | |
| * 13-0938 | For Schlage L | |
| 01-1121 | Cam Screws (Price/Pack - 100 cams) | \$28.35 |

| Rim Cylinder Parts | | Specify Finish |
|--------------------|-----------------------------|----------------|
| 13-0090 | 6 Pin Cylinder Plug | \$29.65 |
| 13-0587 | 7 Pin Cylinder Plug | \$29.65 |
| 13-2005 | 6 Pin Cylinder Body & Slide | \$44.04 |
| 13-2712 | 7 Pin Cylinder Body & Slide | \$44.04 |
| 13-0074 | Connecting Screws 2-1/8" | \$0.66 |
| 13-0080 | Plug Retainer | \$1.54 |
| 13-0085 | Connecting Bar 2-1/2" | \$1.54 |
| 13-0086 | Rim Cylinder Back Plate | \$2.25 |
| 13-0075 | Connecting Screws 2-3/4" | \$1.70 |

* See CK-7 for removable core cams.

CK-6 CYLINDERS & KEYING

SARGENT®

CYLINDERS & ACCESSORIES

ASSA ABLOY

USA & Canada Prices Effective June 3, 2019

Note: Mortise & Rim cylinders are available in US3, 4, 9, 10, 10B, 10BE, 10BL, 14, 15, 20D, 32, 32D, BSP, WSP finishes.
Cylinder plugs/barrels will be in either US4 or 15. Specify finish when ordering.

| Cylinder Rings | | Price Per Each Piece |
|----------------|--|---|
| Number | Description | 03/04/09/10/10B/10BE/10BL/14/15/20D/26/26D/32/32D/BSP/WSP |
| 90 | 1/16", 1/8", 3/16", 1/4", 3/8" (Blocking Rings) | \$7.72 |
| 97 | 9/32" (Rosette) – standard for cylinders ordered w/o hardware (N/A 26/26D) | \$7.72 |

| Mortise Lock Cylinder Rosettes | | Price Per Each Piece |
|--------------------------------|---------------------------------------|---|
| Number | Description | 03/04/09/10/10B/10BE/10BL/14/15/20D/26/26D/32/32D/BSP/WSP |
| 1KA-1 | Cylinder Rosettes – 5/16" Projection | \$64.00 |
| 1KA-2 | Cylinder Rosettes – 7/16" Projection | \$69.00 |
| 1KA-3 | Cylinder Rosettes – 9/16" Projection | \$74.00 |
| 1KA-4 | Cylinder Rosettes – 11/16" Projection | \$81.00 |
| 1KB-1 | Cylinder Rosettes – 5/16" Projection | \$17.00 |
| 1KB-2 | Cylinder Rosettes – 7/16" Projection | \$17.00 |
| 1KB-3 | Cylinder Rosettes – 9/16" Projection | \$17.00 |
| 1KB-4 | Cylinder Rosettes – 11/16" Projection | \$22.00 |
| 1SB-1 | Cylinder Rosettes – 5/16" Projection | \$46.00 |
| 1SB-2 | Cylinder Rosettes – 7/16" Projection | \$49.00 |
| 1SB-3 | Cylinder Rosettes – 9/16" Projection | \$49.00 |
| 1SB-4 | Cylinder Rosettes – 11/16" Projection | \$49.00 |

| Cylinder Turn Knobs | | Add |
|-------------------------|---|---------------------|
| Option | Description | |
| 124 | Cylinder Turn Knobs | \$35.00 |
| Number | | 04/10B/10BE/BSP/WSP |
| 41 thru Size 46 | Sizes 41-46 standard cam | |
| 41-105 thru Size 46-105 | Sizes 41-46 inside cylinder for 78/82 (16 & 92) functions | \$89.00 |
| 41-101 thru Size 46-101 | Sizes 41-46 for #1850 Adams Rite Lock | |

| Mail Box Cylinder | | Finishes |
|-------------------|-------------------------------------|----------|
| Number | | 04/15 |
| 4101 | | \$109.00 |
| 01-4169 | Cam Screw (2 required per cylinder) | \$0.56 |
| 13-0525 | 4101 Plug | \$29.65 |
| 13-0527 | Cam | \$3.09 |
| 06-0166 | Retaining Ring | \$2.02 |

Note: U.S. Postal regulations DO NOT allow masterkeyed Mail Box Cylinders.
Available Keyed Different ONLY.

USA & Canada Prices Effective June 3, 2019

| T-Zone (11-Line) 10L, 6500L, 7L Cylinder Assemblies and Components | | |
|--|--|----------|
| Part# | Description | Price |
| *C11-1 | Cylinder - 11L T-Zone Lever Lock (except 50 function) | \$87.00 |
| *C11-2 | Cylinder - 11L T-Zone Lever Lock - 50 function | \$128.00 |
| *C10-1 | Cylinder - 10, 8L, 7L, 6500 Lever Lock | \$87.00 |
| *C10-2 | Cylinder - 10, 8L, 7L, 6500 Lever Lock - 50 function | \$128.00 |
| 13-3257 | Body & Slide Assy. (11, 10, 7, 6500) | \$40.77 |
| *13-3142 | Cyl. Plug & Ring Assy. (11, 10, 7, 6500) | \$29.65 |
| 11-0231 | Cyl. tailpiece for VC 11 line | \$1.66 |
| 05-0017 | Plastic Cyl. Support Ring (6500) | \$0.40 |
| 05-0028 | Cyl. Retainer Lever (6500) | \$0.75 |
| 05-0040 | Cyl. Tailpiece-6500 7-Pin XC | \$7.21 |
| 10-0019 | Plastic Cyl. Support Ring (10L) | \$0.64 |
| 10-0239 | Cyl. Tailpiece 6-Pin (SFIC & LFIC - 6500, 10L, 7L) Except 54 Function | \$1.85 |
| 10-0240 | Cyl. Tailpiece 7-Pin (SFIC-10L, 6500, 7L) Except 54 Function | \$1.85 |
| 10-0286 | Cyl. Tailpiece 6-Pin (54 function 10L, 7L) | \$1.85 |
| 10-0287 | Cyl. Tailpiece 7-Pin (54 function - 10L, 7L) | \$1.85 |
| 10-0842 | Tailpiece (10 Line) for Schlage SF option | \$4.76 |
| 11-0403 | Tailpiece (11 Line) for Schlage SF prefix | \$4.50 |
| 10-3138 | Cyl. Tailpiece-10L, 7L 7-Pin XC | \$6.18 |
| 11-0171 | Cyl. Tailpiece 6-Pin (SFIC - 11L) | \$1.66 |
| 11-0172 | Cyl. Tailpiece 6-Pin (LFIC-11L) & 7-Pin (SFIC-11L) | \$1.66 |
| 11-0276 | Cyl. Tailpiece-11L 7-Pin XC | \$5.96 |
| *13-0201 | Cyl. Plug - 11L 50 function | \$46.95 |
| 13-0205 | Plug Retaining Ring (11L, 10L, 7L, 6500) | \$2.02 |
| 13-0680 | Cyl. Tailpiece Retainer (11L, 10L, 7L, 6500) | \$2.02 |
| 13-0895 | Cyl. Tailpiece (10L, 7L, 6500) | \$2.06 |
| 13-1385 | Cyl. Tailpiece (11L) | \$2.06 |

| 9, 8, 8X Line Cylinder Assemblies and Components | | |
|--|---|----------|
| | | Price |
| * C8-1 | Cylinder - 9, 8L Knob Locks (except 50 function) | \$87.00 |
| * C8-2 | Cylinder - 9, 8L Knob Locks - 50 function | \$128.00 |
| * C8X-1 | Cylinder - 8X Knob Locks - All except 50 function | \$87.00 |
| 13-2048 | 9, 8L Cylinder Body & Slide Assembly. | \$40.77 |
| 13-0920 | 8X Cylinder Plug | \$29.65 |
| * 13-3425 | 9, 8L Cylinder Plug & Pin | \$29.65 |
| 06-0166 | 9, 8L Plug Retaining Ring | \$2.02 |
| 13-0205 | Plug Retaining Ring (11L, 10L, 7L, 6500) | \$2.02 |

| 6 Line Cylinder Assemblies and Components | | |
|---|---|----------|
| | | Price |
| * C6-1 | Cylinder - 6L Knob Lock (S & N knobs) | \$87.00 |
| * C6-1B | Cylinder - 6L Knob Lock (B knob) | \$87.00 |
| * C6-2 | Cylinder - 6L Knob Lock (S & N knobs) - 50 function | \$128.00 |
| * C6-2B | Cylinder - 6L Knob Lock (B knob) - 50 function | \$128.00 |
| 13-3257 | Cylinder body & Slide Assembly | \$40.77 |
| * 13-3142 | Cylinder Plug & Ring Assembly | \$29.65 |
| 13-0907 | Cylinder Tailpiece (S & N Knobs) | \$2.02 |
| 13-0908 | Cylinder Tailpiece (B Knob) | \$2.02 |
| 13-0205 | Plug Retaining Ring | \$2.02 |
| * 13-0674 | Cylinder Plug/No Ring-50 function | \$29.65 |
| 13-0845 | Cylinder Tailpiece (S + N Knobs-50 function) | \$2.02 |
| 13-0846 | Cylinder Tailpiece (D Knob-50 function) | \$2.02 |
| 13-0680 | Tailpiece Retainer Ring | \$2.02 |

• **460 series has been discontinued**
***Specify Finish – US4 or US15**

ASSA ABLOY, the global leader
in door opening solutions

| 5, 5500 Series Cylinder Assemblies & Components | | |
|---|-------------------------------|---------|
| | | Price |
| * C5500-1 | Cylinder - 5L, 5500 Knob Lock | \$80.00 |
| 13-3514 | Cylinder Body/Slide | \$40.77 |
| * 13-0920 | Cylinder Plug | \$29.65 |
| 13-0919 | Cylinder Tailpiece | \$2.02 |
| 01-0870 | Plug Retaining Ring (5500) | \$2.02 |
| 05-0214 | Retainer (5-Line only) | \$5.23 |

| • 460/470/480 Deadbolt Cylinder | | |
|---------------------------------|--|---------|
| | | Price |
| * C480-1 | Cylinder - 484, 474 Aux Lock | \$87.00 |
| * C480-2 | Cylinder - 485, 487 Aux Lock | \$87.00 |
| * C480-3 | Cylinder - 475, 486 Aux Lock | \$87.00 |
| * C460-1 | Cylinder - 464 Aux Lock | \$87.00 |
| * C460-2 | Cylinder - 465 Aux Lock | \$87.00 |
| 13-3493 | Cylinder Body/Slide Assembly | \$40.77 |
| * 13-0874 | Cylinder Plug (470, 480) | \$29.65 |
| * 13-0904 | Cylinder Plug (* 460) | \$29.65 |
| * 13-0178 | Cylinder Plug (4142, 4143) | \$29.65 |
| 13-0875 | Cylinder Cap (470, 480) | \$3.09 |
| 13-0903 | Cylinder Cap (460) | \$3.09 |
| 13-0884 | Blocking Piece | \$1.03 |
| 13-0691 | Cylinder Cap Pin for (460, 470, 480) made before 6/03 | \$1.03 |
| 13-0693 | Cylinder Cap Spring (460, 470, 480) made before 6/03 | \$1.03 |
| 13-0878 | Tailpiece (464, 474, 484 -1-3/4" Dr. only) | \$1.94 |
| 13-0880 | Tailpiece (465, 485, 487) | \$1.94 |
| 13-0881 | Tailpiece (486, 475) | \$2.61 |
| 13-0882 | Cylinder Tail Washer (484) | \$2.02 |
| 13-0883 | Cylinder Tail Washer (465, 475, 485, 486, 487) | \$2.02 |
| 13-1554 | Cap Pin (460, 470, 480) made after 6/03 | \$1.06 |
| 13-1555 | Cap Spring (460, 470, 480) made after 6/03 | \$1.06 |

| 7600 Integrallock Cylinders (All functions except 26, 27 & 50) | | |
|--|------------------------------------|----------|
| Option Number | Description | Price |
| | * C7600-1 Regular | \$130.00 |
| 10 | * C7600-1 Signature | \$188.00 |
| 10-21 | * C7600-1 Construction & Signature | \$220.00 |
| 21 | * C7600-1 Construction | \$162.00 |
| | 13-0080 Barrel Retainer | \$1.54 |
| | 13-1116 Adaptor for 7600 | \$35.22 |
| | 13-1139 Cylinder Body 6-Pin | \$42.63 |
| | 13-1140 Cylinder Body-Signature | \$42.63 |

| 758/858 Padlock | | |
|-----------------|---|---------|
| | | Price |
| C750-1 | 758/858 Cylinder & Tailpiece Assembly | \$87.00 |
| 13-1230 | 758 Cylinder Tailpiece | \$1.87 |
| 13-1231 | Tailpiece (60-) for 758/858 | \$3.86 |
| 17-2633 | 758/ 858 Cylinder retainer and screw pack | \$14.13 |
| 13-4065 | 63-758/858 Cylinder & Tailpiece Assembly | \$91.59 |
| 01-9219 | 858 Cyl. retainer screw | \$5.26 |

CK-8 CYLINDERS & KEYING

SARGENT®

XC SERIES

ASSA ABLOY

USA & Canada Prices Effective June 3, 2019

XC Cylinders and Key System - OPTION (to be added to all applicable products, except where noted in product catalogs)

| Option | Description | Add |
|--------|---|-------------|
| 11 | XC Key System - Includes 2 change keys standard | No addition |

Notes: When expanding existing key systems, a copy of the existing bitting list is required at time of order, if not already on file w/SARGENT Key records department.

XC options not available with the following options: 10, 22, 35, 51, 52, SC, SE

XC options not available with the following lock functions: 50

Available in Small Format Interchangeable core - refer to CK-13 for prices

Orders for new masterkeyed systems will receive 6 master keys. For additional, please note on order.

Keyways available:

SARGENT keyway families: L, R

Prior authorization from SARGENT key records is required before establishing a new key system

Keying Charges & Substitutions Add

| | |
|---|--------------|
| Masterkeying or Higher level of keying, any quantity | |
| Masterkeying or Higher level of keying, any quantity, cylinder only | \$16.00 /cyl |
| Construction Masterkeying (21-) with cylinders only | |
| Construction Masterkeying (21-) with lockset or exit device or cylinder | |

Cut Master/Change (Day) Keys

| Option | Number | Description | Price Each |
|--------|----------|-----------------------------------|------------|
| 11 | X6272MK | Masterkey, Grandmasterkey – 6 pin | |
| 11 | X6272CMK | Construction Masterkey – 6 pin | \$9.00 |
| 11 | X6272CHK | Change (Day) Key – 6 pin | |

Keyblanks - Packed 50 per Box Keyway Families Available

| Option | Number | Description | Price Each |
|--------|--------|---------------------------------|----------------|
| 11 | X6270 | Master Keyblanks 6-Pin L, R | |
| 11 | X6275 | Day/Change Keyblanks 6-Pin L, R | refer to CK-15 |

Note: All SARGENT XC keyblanks are identified with the following markings: SARGENT, "XC", "PAT. 6,526,791" and DO NOT DUPLICATE"

Extra Keys - Cylinders are packed standard with 2 change keys each Price

| | |
|---|------------------|
| For each extra key ordered with locksets, exit devices or cylinders | \$5.00 /key |
| For keys packed separately | \$4.00 /cylinder |

Additional Charges:

Key Marking - Special marking is limited to space on blank side of keyblank

Visual Key Control -

Delete SARGENT logo

Restricted Keyway - for charges

All orders for restricted keyblanks, barrels, or product containing cylinders that have a restricted keyway must include a letter of authorization or a copy of purchase order from the end user.

Prior authorization from SARGENT key systems is required before establishing a new key system that requires a restricted keyway.

Refer to CK-3

USA & Canada Prices Effective June 3, 2019

Note: Mortise & Rim cylinder housings include #97 Rossette are available in the following finishes: 3, 4, 9, 10, 10B, 10BE, 10BL, 14, 15, 20D, 32, 32D, BSP, WSP. Bored Cylinder Assemblies, cylinder plugs/barrels are available in the following finishes: 4, 15.

| Mortise Cylinder 6 Pin (The XC add is included) | | |
|---|------------------------------|----------|
| Number | Specify finish when ordering | Price |
| 11-41, 11-42, 11-43, 11-44, 11-46 | | \$89.00 |
| 11-48, 11-50, 11-52, 11-54 | | \$130.00 |
| 11-56 | | \$319.00 |
| Note: Price does not include Masterkeying | | |

| Body & Slide - 6-Pin - Mortise Cylinder (11-40 Series) | | |
|--|------------------------------|---------|
| Number | Specify finish when ordering | Price |
| 13-4301 | for #41 | |
| 13-4302 | for #42 | |
| 13-4303 | for #43 | \$44.04 |
| 13-4304 | for #44 | |
| 13-4305 | for #46 | |
| 13-4306 | for #48 | |
| 13-4307 | for #50 | |
| 13-4308 | for #52 | \$63.48 |
| 13-4309 | for #54 | |
| 13-4310 | for #56 | |

| Plug - 6-Pin - Mortise Cylinder (11-40 Series) | | |
|--|--------------------------|---------|
| Number | Specify finish (4 or 15) | Price |
| 13-4314 | for #41 | |
| 13-4315 | for #42 | |
| 13-4316 | for #43 | \$29.65 |
| 13-4317 | for #44 | |
| 13-4318 | for #46 | |
| 13-4319 | for #48 | |
| 13-4320 | for #50 | |
| 13-4321 | for #52 | \$44.49 |
| 13-4322 | for #54 | |
| 13-4323 | for #56 | |

| Optional Cams for use w/11-40 Series Mortise Cylinders | | |
|--|--|-------------|
| Cam No. | | Add/cyl |
| 101 | For Adams Rite 1850, 4700 | |
| 105 | SARGENT Short Cams I/S 78/82 (16 & 92) functions | No Addition |
| 106* | For Schlage "L" | |
| 112 | "Open" Misc. - Wide Straight Cam | |
| 113* | For 4370 Key Switch Coverleaf Cam | |
| 01-1121 | Cam Screw (Price/Pack - 100 cams) | \$28.35 |

Note: when ordering screws, order in multiples of 100

| Rim Cylinder (The XC add is included) | | |
|---|------------------------------|---------|
| Number | Specify finish when ordering | Price |
| 11-34 | | \$89.00 |
| Note: Price does not include Masterkeying | | |

| Body & Slide - 6-Pin - Rim Cylinder (11-34 series) | | |
|--|------------------------------|---------|
| Number | Specify finish when ordering | Price |
| 13-4301 | | \$44.04 |

| Plug - 6-Pin - Rim Cylinder (11-34 series) | | |
|--|--------------------------|---------|
| Number | Specify finish (4 or 15) | Price |
| 13-4312 | | \$29.65 |

| Bored Cylinder Assembly 6 Pin (The XC add is included) | | |
|--|---|----------|
| Option/Number | Specify finish (4 or 15) | Price |
| 11 C11-1 | for T-Zone | |
| 11 C10-1 | for 10, 7L, 6500 (8 Line lever) | |
| 11 C8-1 | for 8, 9 (7 Line knob) | |
| 11 C8X-1 | Cylinder - 8X Knob Locks All Except 50 Function | |
| 11 C6-1 | for 6 Line (S & N knobs) | |
| 11 C6-1B | for 6 Line (B knob) | \$87.00 |
| 11 C5500-1 | for 5500 | |
| 11 C480-1 | for 474, 484 | |
| 11 C480-2 | for 485, 487 | |
| 11 C480-3 | for 475, 486 | |
| 11 C460-1 | for 464 | |
| 11 C460-2 | for 465 | |
| 11 C750-1 | for 758 Padlock | |
| 11 C7600-1 | for 7600 Integra (Except 26, 27, & 50) | \$130.00 |

Note: Price does not include Masterkeying

Note: Above available for all functions except 50 function

| Cylinder Body - Bored Lock | | |
|----------------------------|---|---------|
| Number | | Price |
| 13-4334 | for T-Zone, 10, 7L, 6500 (8 Line lever) | |
| 13-4335 | for 8, 9 (7 Line knob) | |
| 13-4336 | for 6 Line (B, S & N knobs) | |
| 13-4338 | for 5500 | \$40.77 |
| 13-4337 | for 460, 470, 480 Series | |
| 13-4334 | for 758 Padlock | |
| 13-4339 | for 7600 Integra Lock | \$42.63 |

| Barrel/Plug Assembly - Bored Lock | | |
|-----------------------------------|---|---------|
| Number | Specify finish (4 or 15) | Price |
| 13-4332 | for T-Zone, 10, 7L, 6500 (8 Line lever) | |
| 13-4332 | for 6 Line (B, S & N knobs) | |
| 13-4331 | for 8, 9 (7 Line knob) | |
| 13-4328 | for 5500 | \$29.65 |
| 13-4330 | for 480, 470 Series | |
| 13-4329 | for 460 Series | |
| 13-4332 | for 758 Padlock | |
| 13-4312 | for 7600 Integra Lock | \$29.65 |

CK-10 CYLINDERS AND KEYING

SARGENT®

LARGE FORMAT IC CORE CYLINDERS & OLD STYLE REMOVABLE CORE CYLINDERS

ASSA ABLOY

USA & Canada Prices Effective June 3, 2019

Note: Mortise & Rim cylinder housings include #97 Rossette are available in US3, 4, 9, 10, 10B, 10BE, 10BL, 14, 15, 20D, 32, 32D, BSP, WSP finishes. Bored cylinder plugs/barrels/cores will be in either US4 or 15. Specify finish when ordering.

| SARGENT Large Format Interchangeable Core Mortise & Rim Cylinders - Includes Master & Grand Master Keying Charges | | Price |
|---|--|---------------------------|
| Number | | Specify Finish |
| 6334 (rim), 6342, 6343, 6344, 6346 | 6-Pin only | \$166.00 |
| 50-6343 | 6-Pin only - Hotel cylinder | \$195.00 |
| SARGENT Large Format Interchangeable Cores ONLY - Includes Master & Grand Master Keying Charges | | |
| 6300 | 6-Pin | \$77.00 |
| SARGENT Large Format Interchangeable Core Housings - Mortise (includes standard Cam unless specified other) & Rim Bodies ONLY | | |
| 6034 (Rim), *6042, *6043, *6044, *6046 | 6-Pin only | \$89.00 |
| 50-6043 | 6-Pin only - Hotel Cylinder | \$118.00 |
| Cut Master/Change (Day) Keys | | |
| 6272CTL | Control Key | \$9.00 |
| 6272MK | Master Key | |
| 6272CHK | Change (Day) Key | |
| *Cylinders with following Cams (6042, 6342, 6043, 6343, 6044, 6344, 6046, 6346 Cylinders) | | |
| 101 | For Adams Rite – 1850, 4700 | No Addition |
| 105 | Sargent Short Cam – for 16 & 92 functions | |
| 106 | For Schlage L | |
| 112 | "Open" Misc. – Wide Straight Cam | |
| 113 | For 4370 Key Switch | |
| 115 | SARGENT Removable (63-) Hotel (50-) Cam for 50-60/63-43 cyl. | |
| Note: *Cams must be ordered with cylinders – permanently attached at the factory. | | |
| SARGENT Large Format Interchangeable Cores ONLY - Unassembled | | |
| 65-6300** | H-Keyway – standard – other Keyways available | \$67.00 |
| 65-50-6300** | Hotel Cores - C family Keyway-standard | |
| Disposable Plastic Core (60-Option) | | |
| 13-5177 | Plug Assembly (RC-60) | \$4.23 |
| 6300 Plug/Parts | | |
| 13-0795 | 6-Pin – Barrel | \$29.65 |
| 13-3424 | Inner Body and Slide Assy for 6300 | \$29.65 |
| 13-0796 | Control Sleeve for 6300 | \$25.75 |
| 01-0660 (Price/Pack - 100 rings) | Retaining Ring for 6300 & 10-6300 & 11-6300 | \$87.55 |
| 13-0797 (Price/Pack - 100 slides) | Slide for 6300 made before 3/06 w/box logo | \$39.46 |
| 13-1341 (Price/Pack - 100 slides) | Slide for 6300 made after 4/06 w/o box logo | \$39.46 |
| Removable Core Cylinders - OLD STYLE - FOR EXISTING SYSTEMS ONLY - Prices DO NOT include keying charges. | | Specify Finish |
| 51 Option | Permanent Core | Add \$78.00 Each Cylinder |
| 52 Option | Construction Core | See CK-2 |
| Removable Core Cylinders - OLD STYLE - FOR EXISTING SYSTEMS ONLY - Prices DO NOT include keying charges | | Specify Finish |
| 134 | Rim | 7-Pin |
| 142, 143, 144, 146 | Mortise | 7-Pin |
| | | \$88.00 |
| Note: Must specify 51- (permanent core) or 52- (construction core) option when ordering old style removable core cylinders | | |
| Removable Core ONLY - OLD STYLE - FOR EXISTING SYSTEMS ONLY - Prices DO NOT include keying charges. | | Specify Finish |
| 5134 | (for Rim) | 7-Pin |
| 5142, 5143, 5144, 5146 | (for Mortise) | 7-Pin |
| | | \$78.00 |
| Plug ONLY - OLD STYLE | | Specify Finish |
| 13-0402 | Mortise Plug | 7-Pin |
| 13-0242 | Rim Plug | 7-Pin |
| | | \$29.65 |
| | | \$37.63 |
| Mortise and Rim Housing Only - OLD STYLE | | Specify Finish |
| 13-2052 | Mortise | 7-Pin |
| 13-2053 | 1-3/8" long mortise body only | |
| 13-2054 | 1-1/2" long mortise body only | |
| 13-2055 | 1-3/4" long mortise body only | |
| 13-2057 | Rim 5&6-Pin back plate and screws to be ordered separately | |
| 13-0265 (Price/Pack - 100 springs) | Spring for all chambers except control | \$14.80 |
| 13-0215 (Price/Pack - 100 springs) | Spring only for control chamber | \$87.55 |
| 13-1797 (Price/Pack - 100 springs) | 7-pin Slide without box logo | \$77.67 |

**Specify finish – US4 or US15

SARGENT XC LARGE FORMAT INTERCHANGEABLE CORE CYLINDERS

USA & Canada Prices Effective June 3, 2019

Note: Mortise & Rim cylinders include #97 Rossette are available in US3, 4, 9, 10, 10B, 10BE, 10BL, 14, 15, 20D, 32, 32D, BSP, WSP finishes. Cylinder plugs/barrels/cores will be in either US4 or 15. Specify finish when ordering.

| SARGENT XC Large Format Interchangeable Core Options: | | |
|---|---|-------------|
| Options | Description | Add |
| 1160 | SARGENT XC Large Format Interchangeable Core - plastic disposable core provided | No Addition |
| 1163 | SARGENT XC Large Format Interchangeable Core - 6 pin keyed | \$77.00 |
| 1164 | SARGENT XC Large Format Interchangeable Core, 6-Pin construction core provided | \$77.00 |

Note: 11-6300 core will only work in Sargent hardware ordered with 11-60, 11-63, or 11-64 options.

| Option | No. | Cut Master/Change (Day) Keys | |
|--------|----------|--|--------|
| 11 | X6272CTL | Control key | |
| 11 | X6255CTL | Control key for 1 bitted 11-6300 cores | |
| 11 | X6272MK | Masterkey | \$9.00 |
| 11 | X6272CHK | Change (Day) Key - 6 Pin | |

| Retrofit Parts/Tail Pieces required with hardware not ordered to accept 11-6300 core | | Price |
|--|---|----------|
| 08-5265 | 10-60-63 8 Line Knob Parts Pack | \$39.00 |
| 10-3429 | 10, 7, 6500 Tail Piece & Retainer Pack | \$8.99 |
| 11-5003 | 11 Line "T-Zone" Tail Piece & Retainer Pack | \$8.23 |
| 13-5178 | 11-60-63-34 Rim Cylinder Parts Pack | \$35.01 |
| 16-2508 | 460 Series Cam Assembly | \$3.64 |
| 17-2632 | 758/858 Tail Piece & Retainer Pack | \$10.26 |
| 431-6 | Shear Tool used to modify existing 60- Mortise cylinder housings to accept 11-6300 core | \$417.00 |
| 432RC | Mortise Removable Core Cylinder Installation Tool | \$71.00 |

| XC Large Format Interchangeable Core Mortise & Rim Cylinders - Includes Master & Grand Master Keying Charges Price | | Price Specify Finish |
|---|------------|-------------------------|
| 11-6334 (Rim), 11-6342 | 6-Pin Only | |
| 11-6343, 11-6344 | 6-Pin Only | \$166.00 |
| 11-6346 | 6-Pin Only | |

| XC Large Format Interchangeable Core ONLY - Includes Master & Grand Master Keying Charges | | |
|---|-------|---------|
| 11-6300 | 6-Pin | \$77.00 |

| XC Large Format Interchangeable Core Cylinders - Mortise (includes standard Cam unless specified other) & Rim Bodies ONLY | | |
|---|------------|---------|
| 11-6034 (Rim), *11-6042 | 6-Pin Only | |
| *11-6043, 11-6044 | 6-Pin Only | \$89.00 |
| 11-6046 | 6-Pin Only | |

| *Cylinders with following optional Suffix Cams (11-6042, 11-6342, 11-6043, 11-6343, 11-6044, 11-6344, 11-6046, 11-6346 Cylinders) | | |
|---|---|-------------|
| 101 | For Adams Rite – 1850, 4700 | |
| 105 | Sargent Short Cam – for 78/8200 16 & 92 functions | |
| 106 | For Schlage L | No Addition |
| 112 | "Open" Misc. – Wide Straight Cam | |
| 113 | For 4370 Key Switch | |

| Removable Cores ONLY - Unassembled | | |
|------------------------------------|--|---------|
| 11-65-6300** | | \$67.00 |

| Disposable Plastic Core (11-60 Option) | | |
|--|---------------|--------|
| 13-5177 | Plug assembly | \$4.23 |

| 11-6300 Plug/Parts | | |
|-----------------------------------|---|---------|
| 13-4326 | 6-Pin Barrel XC | \$29.65 |
| 13-5175 | Inner Body and Slide Assy for 11-6300 | \$29.65 |
| 13-0796 | Control Sleeve for 6300 & 11-6300 | \$25.75 |
| 01-0660 (Price/Pack - 100 rings) | Retaining Ring for 6300, 10-6300, & 11-6300 | \$87.55 |
| 13-1341 (Price/Pack - 100 slides) | 6-pin Slide for 6300 made after 4/06 without box logo | \$39.46 |

Note: Cylinders shipped less hardware comes with #97 cylinder ring.

CK-12 CYLINDERS AND KEYING

SARGENT®

SMALL FORMAT INTERCHANGEABLE CORE

ASSA ABLOY

USA & Canada Prices Effective June 3, 2019

| SMALL FORMAT INTERCHANGEABLE CORE OPTION (to be added to all applicable products, except where noted in product catalogs) | | |
|---|--|--------------|
| Options | Description | Add |
| 70 | Small Format Interchangeable core - plastic disposable core provided | No addition |
| 72 | Small Format Interchangeable core - 6-Pin construction core provided | \$69.00 |
| 73 | Small Format Interchangeable core - 6-Pin keyed - Includes Master & Grand Master Keying charges | \$69.00 /cyl |
| 73-7P | Small Format Interchangeable core - 7-Pin keyed - Includes Master & Grand Master Keying charges | |

Notes: Orders with Small Format Interchangeable type construction cores (72-) receive 6 construction keys and 1 control key per order as standard. For additional, please note on order.
Orders for new masterkeyed systems will receive 6 master keys. For additional, please note on order.
Mortise cylinder offered size #43 or 46 with SARGENT offset cam only;
Rim cylinders size #34 only with SARGENT hole pattern.
When expanding existing key systems, a copy of the existing bitting list is required at time of order, if not already on file w/SARGENT Key records department.

Keyways available:

Small format competitor keyway: A, B, C, D, E, F, G, H, J, K, L, M.
Small format SARGENT keyway: 4A standard, 4B restricted keyway - A2 or A4 System.

Prior authorization from SARGENT key records is required before establishing a new key system.

| Cut Master Keys and Change Keys | | Price Each |
|---------------------------------|--|------------|
| 6282BMK | Masterkey/Grandmasterkey – 6 pin | \$9.00 |
| 7282BMK | Masterkey/Grandmasterkey – 7 pin | |
| 6254BCTL | Construction Control Key (72-) 6 pin | |
| 6282BCMK | Construction Masterkey (72-) 6 pin | |
| 6282BCTL | Control Key (73-) 6 pin permanent core | |
| 7282BCTL | Control Key (73-) 7 Pin permanent core | |
| 6282BCHK | Day/change key (73-) - 6 pin | |
| 7282BCHK | Day/Change key (73-7P) - 7 pin | |

| Keyblanks - Packed 50 per Box | | Price |
|-------------------------------|--|--------|
| 6285B | Small Format system Keyblanks - 6 Pin - specify keway required - example: 6285BA | \$2.71 |
| 7285B | Small Format system 7 pin Keyblanks specify keway required - example: 7285B-4A | |
| 6285B4B | Small Format system Keyblanks - 6 Pin Restricted Keyway - example: 6285B4B | \$5.66 |
| 7285B4B | Small Format system 7 pin Keyblanks - Restricted Keyway - example: 7285B 4B | |

| Visual Key Control | | Price |
|---|--|-------------|
| Stamping of cylinder plug not available, stamping of the keys with key set standard | | N/A |
| Each additional key stamped | | \$1.00 /key |
| Concealed Stamping of Keyset on core (7 Characters) | | \$8.00 /cyl |
| Cylinder permanent stamping options: Cylinder plug/barrel face | | N/A |

Additional Charges:

| | |
|--|---------------|
| Extra Keys - | Refer to CK-3 |
| Key Marking - Special marking is limited to space on blank side of keyblank | Refer to CK-3 |
| Delete SARGENT Logo/Key Section | N/A |
| Restricted Keyway - for charges | Refer to CK-3 |
| Less Logo/Key Section | N/A |

| Mortise/Rim Cylinder with IC Core, Cylinder Shells | | | IC Cores ONLY – Keyed, Uncombined, Construction Cores | | |
|--|--|----------|---|---------------------------------|---------|
| Number | Description | Price | Number | Description | Price |
| 73-43 | 1-3/8" Mortise 6-Pin w/SARGENT cam | \$158.00 | 7300B | 6-Pin Master keyed core | \$69.00 |
| 73-46 | 1-3/4" Mortise 6 Pin w/SARGENT cam | | 7P-7300B | 7-Pin Master keyed core | |
| 73-34 | Rim 6-Pin | | 65-7300B | 6-Pin uncombined - no keyblanks | \$59.00 |
| 73-7P-43 | 1-3/8" Mortise 7-Pin w/SARGENT cam | | 65-7P-7300B | 7-Pin uncombined - no keyblanks | |
| 73-7P-46 | 1-3/4" Mortise 7-Pin w/SARGENT cam | \$89.00 | 7200 | 6 Pin Construction core (72-) | \$69.00 |
| 73-7P-34 | Rim 7-Pin | | 13-5176 | Disposable plastic core - assy | \$2.04 |
| 70-43 | 1-3/8" Mortise 6 or 7 Pin cylinder shell | | 13-1507 | 70-34 rim cylinder tail piece | \$2.01 |
| 70-46 | 1-3/4" Mortise 6 or 7 Pin cylinder shell | | | | |
| 70-34 | Rim 6 or 7 Pin cylinder shell | | | | |

Note: Specify finish: 3, 4, 9, 10, 10B, 10BE, 10BL, 14, 15, 20, 26, 26D, BSP, WSP.

ASSA ABLOY, the global leader
in door opening solutions

Copyright © 2002-2019 Sargent Manufacturing Company, an ASSA ABLOY Group company. All rights reserved.
Reproduction in whole or in part without the express written permission of Sargent Manufacturing Company is prohibited.
Contact us at: 800-727-5477 or visit www.sargentlock.com. In Canada contact us at: 800-461-3007 or visit www.assaabloydss.ca

XC SMALL FORMAT INTERCHANGEABLE CORE OPTIONS

(to be added to all applicable products, except where noted in product catalogs)

| Options | Description | Add |
|---------|---|--------------|
| 1170 | XC Small Format Interchangeable core - plastic disposable core provided | No addition |
| 11727P | XC Small Format Interchangeable core - 7-Pin construction core provided | \$69.00 |
| 11737P | XC Small Format Interchangeable core - 7-Pin keyed - Includes Master & Grand Master Keying charges | \$69.00 /cyl |

Notes: For use in Sargent hardware only and only for use in hardware ordered with proper prefixes such as 11-70, 11-72-11-73. Orders with XC Small Format Interchangeable type construction cores (11-72-) receive 6 construction keys and 1 control key per order as standard. For additional, please note on order. Orders for new masterkeyed systems will receive 6 master keys. For additional, please note on order. Mortise cylinder size #43 with SARGENT offset cam only; Rim cylinder size #34 only with SARGENT hole pattern. When expanding existing key systems, a copy of the existing bitting list is required at time of order, if not already on file w/SARGENT Key records department.

Keyways available:

XC Small format SARGENT keyway families: 4A standard, **4B restricted keyway** - A2 or A4 System

Prior authorization from SARGENT key records is required before establishing a new key system

| Option | Number | Cut Master Keys cut day/change keys | Price Each |
|--------|-----------|-------------------------------------|------------|
| 11 | X7282BMK | XC Masterkey/Grandmasterkey | |
| 11 | X7282BCTL | Control Key - 7 pin | \$9.00 |
| 11 | X7282BCHK | XC day/change key - 7 pin | |
| | 7282BCMK | XC Construction Masterkey 11-72 | |
| | 7254BCTL | XC Construction Control Key 11-72 | |

| Option | Number | Keyblanks - Packed 50 per Box | Price |
|--------|----------|--|--------|
| 11 | X7285B | XC Small Format system Keyblanks - 7 Pin - example: 11-X7285B4A | \$2.71 |
| 11 | X7285B4B | XC Small Format system Keyblanks - Restricted Keyway - example: 11-X7285B4B | \$5.66 |

Prior authorization from SARGENT key records is required before establishing a new key system

Notes: All SARGENT XC keyblanks are identified with the following markings:
SARGENT, "XC", PAT, 6,526,791 and DO NOT DUPLICATE

| Extra Keys - Cylinders are packed standard with 2 keys each | Price |
|---|-------------|
| For each extra key ordered with locksets, exit devices or cylinders | \$5.00 /key |
| For cylinders packed separately | \$4.00 /cyl |

| Visual Key Control | Price |
|---|-------------|
| Stamping of cylinder plug and/or two keys with industry standard alpha numeric keyset symbol (Plug N/A stamped) | N/A |
| Each additional key stamped | \$1.00 /key |
| Stamping code (keyset symbol) on mortise cylinder, rim cylinder, or 11-7300B body | \$8.00 /cyl |
| XC Cylinder permanent stamping options: Cylinder plug/barrel face | N/A |
| XC 11-7300B cores stamped on the side of core with up to 7 characters | \$8.00 /cyl |

Additional Charges:

| | |
|--|---------------|
| Key Marking - Special marking is limited to space on blank side of keyblank | Refer to CK-3 |
| Delete SARGENT Logo/Key Section | N/A |
| Restricted Keyway - for charges | Refer to CK-3 |
| Less Logo/Key Section | N/A |

| Mortise/Rim Cylinder with IC Core, Cylinder Shells | Price |
|--|----------|
| 11737P-34 XC Rim Cyl. 7-Pin | |
| 11737P-43 XC Mortise 7-Pin w/SARGENT cam | \$158.00 |
| 11737P-46 XC Mortise Cyl. 7-Pin | |
| 1170-34 XC Rim 7 Pin cylinder shell | |
| 1170-43 XC Mortise 7 Pin cylinder shell | \$89.00 |
| 1170-46 XC Mortise 7 Pin cylinder shell | |

Note: Specify finish: 3, 4, 9, 10, 10B, 10BE, 10BL, 14, 15, 20, 26, 26D, BSP, WSP

| IC Cores ONLY – Keyed, Uncombined, Construction Cores | Price |
|---|----------|
| 117P-7300B 7-Pin Master keyed core | \$69.00 |
| 11657P-7300B 7-Pin uncombined - no keyblanks | \$59.00 |
| 117P-7200 Construction core (11-72-) | \$69.00 |
| 13-5174 Disp. plastic core - bottom plug (70-) | \$3.64 |
| 431-7 Pin Shear Tool | \$417.00 |
| 05-0040 XC Tailpiece - 6500-7-Pin | \$7.21 |
| 10-3138 XC Tailpiece - 10L-7-Pin | \$6.18 |
| 11-0276 XC Tailpiece - 11L-7-Pin | \$5.96 |
| 13-1507 11-70-34 rim cylinder tail piece | \$2.01 |

CK-14 CYLINDERS & KEYING

SARGENT®

KEYING KITS • TOOLS • GAUGES • COMPONENTS

ASSA ABLOY

USA & Canada Prices Effective June 3, 2019

| Keying Kits • Tools • Gauges | | Price |
|------------------------------|---|----------|
| — | Depth Key Sets | \$55.00 |
| LT2 | Cylinder Loading Thimble | \$62.00 |
| LT6 | Cylinder Loading Rod | \$55.00 |
| 2 | Tru-Arc Plier | \$55.00 |
| 431-6 | Shear Tool used to modify existing 60- Mortise cylinder housings to accept 11-6300 core | \$417.00 |
| 431-7 | Small Format Pin Shear Tool | \$417.00 |
| 432RC | Sargent Removable Core Installation Tool | \$71.00 |
| 432IC | Small Format Interchangeable Core Installation Tool | \$71.00 |
| 436-1 | Top Loading Kit | \$670.00 |
| 435 | Key Gauge | \$38.00 |
| 437BR | Bump Resistant Retrofit pinning Kit | \$421.00 |
| 437C | Rekeying Kit (Conventional Keying) | \$854.00 |
| 437RC | Removable Core Rekeying Kit (Conventional & Signature) | \$401.00 |
| 437S | Signature Re-keying Kit | \$854.00 |
| 439 | Lost Ball (21 Option) Field Construction Keying Kit | \$574.00 |
| 13-1034 | Loading Rod (6, 8, 10L & Mortise) | \$26.59 |
| 13-1035 | Loading rod (480, 6300) | \$39.20 |
| 13-1037 | Pin Loading Rod | \$13.92 |
| 13-1103 | Field Construction Balls (3 required per cylinder) (Price/Pack - 500/pack) | \$135.63 |
| 13-1138 | Spring Loading Rod | \$13.92 |
| 14-0070 | Extractor (Used with 22- Option) | \$5.04 |
| 18-0070 | Cylinder Lube Spray | \$26.59 |
| 18-0435 | Cylinder Cleaner/De-Icer | \$26.59 |
| 77-0273 | Loading Rod | \$21.30 |

| Part No. | Bottom (Key) Pin | Size | Price/Pack (100 Pins) |
|----------|------------------|------|-----------------------|
| 13-0064 | | 1 | |
| 13-0065 | | 2 | |
| 13-0066 | | 3 | |
| 13-0067 | | 4 | \$17.00 |
| 13-0068 | | 5 | (Order in |
| 13-0069 | | 6 | multiples |
| 13-0070 | | 7 | of 100) |
| 13-0071 | | 8 | |
| 13-0072 | | 9 | |
| 13-0073 | | 10 | |

| Cylinder Spring/Slides (100/pack) | | Price/Pack |
|-----------------------------------|--|------------|
| 13-0265 | Springs | \$14.80 |
| 13-0779 | KIK/KIL slides for cyls. made prior to June, 2008 | \$39.46 |
| 13-0797 | Slide for 6300 made before 3/06 with box logo | \$39.46 |
| 13-0487 | Hollow Driver Spring (3rd & 4th) | \$87.55 |
| 13-0215 | Control Spring for Old Style Rem. Core | \$87.55 |
| 13-1341 | KIK/KIL slides for cyls. made after June, 2008 | \$39.46 |
| 13-1769 | Springs for all chambers in factory master keyed 6300s starting 1/1/09 | \$19.72 |

| Signature Cylinder Pins (Optional for 437RC kit) Hardened Stainless Pins (for UL437 Cylinders) | | |
|---|----------|----------------------|
| Part. No. | Size | Price/Pack (25 Pins) |
| 13-1210 | 1 | |
| 13-1211 | 2 | |
| 13-1212 | 3 | |
| 13-1213 | 4 | |
| 13-1214 | 5 | \$87.00 |
| 13-1215 | 6 | (Order in |
| 13-1216 | 7 | multiples |
| 13-1217 | 8 | of 25) |
| 13-1218 | 9 | |
| 13-1222 | B-Driver | |
| 13-1223 | C-Driver | |

Note: To re-key existing Sargent UL437 Cylinders.

| Master Pins (Splits & Drivers) | | Price/Pack (100 Pins) |
|--------------------------------|------|-----------------------|
| Part No. | Size | |
| 13-0051 | 2 | |
| 13-0052 | 3 | |
| 13-0053 | 4 | |
| 13-0054 | 5 | |
| 13-0055 | 6 | |
| 13-0056 | 7 | \$17.00 |
| 13-0057 | 8 | (Order in |
| 13-0058 | 9 | multiples |
| 13-0059 | 10 | of 100) |
| 13-0060 | 11 | |
| 13-0061 | 12 | |
| 13-0062 | 13 | |
| 13-0063 | 14 | |

| For Sargent 6300 LFIC & Signature Removable Core—for 3rd & 4th positions: | | | Price/ Pack (100 Pins) |
|--|----------------|------|------------------------------|
| Part. No. | Hollow Drivers | Size | |
| 13-1229 | | 3 | \$43.00 |
| 13-1234 | | 4 | |
| 13-1235 | | 5 | |
| 13-1236 | | 6 | \$25.00 |
| 13-1237 | | 7 | (Order in |
| 13-1238 | | 8 | multiples |
| 13-1239 | | 9 | of 100) |
| 13-1240 | | 10 | |
| 13-1761 | | 11 | |

| For Sargent 6300 LFIC & Signature Removable Core—Parts: | | Price/Pack (100 Rings) |
|--|----------------|------------------------|
| Part. No. | Miscellaneous | |
| 01-0660 | Retaining Ring | \$87.55 |

| Bump Resistant Pins (Min. Qty. 100 ea.) | | Price/Pk (100 Pins) |
|---|------|---------------------|
| Part No. | Size | |
| 13-1770 | 10 | \$57.00 |
| 13-1773 | 13 | |

| Key Blanks - 5 Pin (Minimum Quantity – 50 each) | | | Price |
|--|---|--------------------------------------|--------------|
| Number | Section | | Per Each Key |
| <i>Single Keyway Systems</i> | | | |
| 265 | U*, R* | | \$2.90 |
| 275 | S* | | \$2.30 |
| *Used on existing systems ONLY. | | | |
| <i>Multi Keyway Systems – Composite Sections</i> | | | |
| 270 | LD, LH, LM, RD, RH, RM | | \$2.60 |
| 270 | LDH, LDM, LHM, LN, RDH, RDM, RHM, RN | | \$2.60 |
| 273 | CD, CH, CM (Large Bow) | | \$4.30 |
| 273 | CDH, CDM, CHM, CN (Large Bow) | | \$4.30 |
| <i>Multi Keyway Systems – Single Sections</i> | | | |
| 275 | LA, LB, LC, LE, LF, LG, LJ, LK, LL, RA, RB, RC, RE, RF, RG, RJ, RK, RL | | \$2.30 |
| Single Keyway System (Large bow) | | | |
| 278 | CR | | \$3.50 |
| Multi Keyway System (Large bow) | | | |
| 278 | CA, CB, CC, CE, CF, CG, CJ, CK, CL | | \$3.50 |
| Key Blanks - 6 PIN (Minimum Quantity – 50 each) | | | |
| <i>Single Keyway Systems</i> | | | |
| 6265 | U*, R* | | \$2.90 |
| 6275 | S* | | \$2.50 |
| *Used on existing systems ONLY. | | | |
| <i>Multi Keyway Systems – Composite Sections</i> | | | |
| 6270 | HD, HH, HM, LD, LH, LM, RD, RH, RM | | \$2.70 |
| 6270 | HDH, HDM, HHM, HN, LDH, LDM, LHM, LN, RDH, RDM, RHM, RN | | \$2.70 |
| <i>Multi Keyway Systems – Composite Sections (Large Bow)</i> | | | |
| 6273 | CD, CH, CM | | \$4.30 |
| 6273 | CDH, CDM, CHM, CN | | \$4.30 |
| <i>Multi Keyway Systems – Single Sections</i> | | | |
| 6275 | HA, HB, HC, HE, HF, HG, HJ, HK, HL, LA, LB, LC, LE, LF, LG, LJ, LK, LL, RA, RB, RC, RE, RF, RG, RJ, RK, RL | | \$2.30 |
| <i>Multi Keyway Systems – Large Bow Single Sections</i> | | | |
| 6278 | CA, CB, CC, CE, CF, CG, CJ, CK, CL | | \$3.50 |
| <i>Single Keyway System - Large Bow</i> | | | |
| 6278 | CR | | \$3.50 |
| <i>Option Number</i> | <i>XC Keyblanks available in L, R Keyway Families</i> | | |
| 11 | X6270 | L, R Master Keyblanks 6-Pin | \$2.80 |
| 11 | X6270 | LD, LH, LM, RD, RH, RM | \$2.70 |
| 11 | X6270 | LDH, LDM, LHM, LN, RDH, RDM, RHM, RN | \$2.80 |
| 11 | X6275 | L, R Day/Change Keyblanks 6-Pin | \$2.30 |
| For keys not shown, consult factory. | | | |
| <i>SFIC Families</i> | | | |
| 6285B | 6 pin -x Keyway – A, B, C, D, E, F, G, H, J, K, L, M, 4A | | \$2.71 |
| 7285B | 7 pin -x keyway – A, B, C, D, E, F, G, H, J, K, L, M, 4A | | \$2.71 |
| <i>XC SFIC Families</i> | | | |
| 11 | X7285B | Keyway – 4A 7 pin blanks | \$2.71 |

CK-16 CYLINDER & KEYING

SARGENT®

KEYBLANKS

ASSA ABLOY

USA & Canada Prices Effective June 3, 2019

| Key Blanks - 7 Pin (Minimum Quantity – 50 each) | | Price |
|--|--|--------------|
| Number | Section | Per Each Key |
| <i>Single Keyway Systems</i> | | |
| 7275 | S* | \$2.50 |
| *Used on existing systems ONLY. | | |
| <i>Multi Keyway Systems – Composite Sections</i> | | |
| 7270 | LD, LH, LM, RD, RH, RM | \$2.80 |
| 7270 | LDH, LDM, LHM, LN, RDH, RDM, RHM, RN | \$2.80 |
| <i>Multi Keyway Systems, Composite Sections (Large Bow)</i> | | |
| 7273 | CD, CH, CM | \$4.30 |
| 7273 | CDH, CDM, CHM, CN | \$4.30 |
| <i>Multi Keyway Systems – Single Sections</i> | | |
| 7275 | LA, LB, LC, LE, LF, LG, LJ, LK, LL, RA, RB, RC, RE, RF, RG, RJ, RK, RL | \$2.50 |
| <i>Multi Keyway Systems – Large Bow Keys</i> | | |
| 7278 | CA, CB, CC, CE, CF, CG, CJ, CK, CL | \$3.50 |
| Restricted Keyblanks - End user authorization letter required with each order. SARGENT Keyway family's – A, B, G, K, N, V | | |
| 6275 | Non-Published (restricted) Day Key Blank (6 pin) | \$3.20 |
| 6270 | Non-Published (restricted) Master Key Blank (6 pin) | \$3.50 |
| 7275 | Non-Published (restricted) Day Key Blank (7 pin) | \$3.30 |
| 7270 | Non-Published (restricted) Master Key Blank (7 pin) | \$3.50 |
| <i>Option Number</i> | <i>XC SFIC</i> | |
| 11 | X7285B 4B Keyway - small format 7 Pin | \$5.66 |
| | 6285B 4B - small format 6 pin | \$5.66 |
| | 7285B 4B - small format 7 pin | \$5.66 |

Note: For anything not listed, consult factory
Consult Factory for Large Bow Keys.

| Cut Master Level/Change (Day) Keys | | |
|------------------------------------|---|-------------|
| Number | Description (provide key system registration # when ordering) | Price Each |
| 272MK | Master Keys – 5 Pin | |
| 6272MK | Master Keys – 6 Pin | |
| 7272MK | Master Keys – 7 Pin | |
| 6250CMK | Construction Master Key (22-) 6 pin | |
| 272CMK | Construction Master Keys - 5 Pin (21-) | |
| 6272CMK | Construction Master Key – 6 Pin (21-) | |
| 7272CMK | Construction Master Keys - 7 Pin (21-) | |
| 6267EMK | Emergency Key, Bored Locks – 6 Pin Key, 6 Pin System | |
| 7268EMK | Emergency Key, Mortise Locks – 7 Pin Key, 6 Pin System | |
| 7269EMK | Emergency Key, Removable Core, Hotel Function – 7 Pin Key, 6 Pin System | |
| 6272CTL | 6 Pin Control Key for 6300s | |
| 6255CTL | Control Key – 1 Bitted for 6300's (63-) | \$9.00 Each |
| 6253CTL | Control Key (51-) | |
| 7253CTL | Control Key – 7 Pin Key – 6 Pin System (51-) | |
| 272CHK | Change (Day) Key - 5 Pin | |
| 6272CHK | Change (Day) Key - 6 Pin | |
| 7272CHK | Change (Day) Key - 7 Pin | |
| 6251CMK | Temporary Construction Removable Core Master Key - 6 pin used with 64-11-64- and DG-64- | |
| 6251CTL | Temporary Construction Removable Core Control Key - 6 pin used with 64-11-64 and DG-64- | |
| 6282BCMK | Construction Interchangeable Core Master Key - 6 pin used with 72- | |
| 6254BCTL | Construction Interchangeable Core Control Key - 6 pin used with 72- | |
| 7282BCMK | Construction Interchangeable Core Master Key - 7 pin used with 11-72- | |
| 7254BCTL | Construction Interchangeable Core Control Key - 7 pin used with 11-72- | |

Note: On new master keyed systems, use keying cover sheets, removable and interchangeable core systems, and construction Master keyed system orders, please specify quantity of master keys, control keys, and master construction keys required. If order does not give quantities of key requirements, a minimum of 6 each master keys will be provided on new master keyed orders; 1 each control key will be provided on new removable core or interchangeable core jobs; 6 each construction master keys and 1 construction control key will be provided for construction keyed orders.

Competitors Keyways

A selection of other manufacturer's keyways are available. Consult optional substitutions in each product section for availability. Not available for Hotel/Motel functions or factory master keyed.

| Manufacturer | Keyway | Description | Option | Finish | Price |
|--------------|----------|-----------------|----------|-------------|----------|
| Best | See CK-8 | See CK-8 | See CK-8 | See CK-8 | See CK-8 |
| Schlage* | C | 6 pin, 0 bitted | SC- | Per product | NC |
| Schlage* | E | 6 pin, 0 bitted | SE- | Per product | NC |

*Mortise Cylinder size 41 ONLY and Rim Cylinder (#34) with SARGENT hold pattern. 2 each 6 Pin key blanks provided.

| Option | Cylinder No. | Description | 04/15 |
|--------|--------------|---|----------------------------------|
| SC | C10-1 | SC Cylinder - 11, 10, 8L, 7L, 6500 Lever Lock x SC (Schlage C keyway) | |
| SE | C10-1 | SE Cylinder - 11, 10, 8L, 7L, 6500 Lever Lock x SE (Schlage E keyway) | \$87.00 |
| SC | C480-1 | SC Cylinder - 470, 480 (Schlage C keyway) | |
| SE | C480-1 | SE Cylinder - 470, 481 (Schlage E keyway) | |
| Option | Cylinder No. | Description | 03/04/10/10BE/10B/26/26D/BSP/WSP |
| SC | 41 | Schlage C 6 pin, 0 bitted 41 mort cyl. only | |
| SE | 41 | Schlage E 6 pin, 0 bitted 41 mort cyl. only | |
| SC | 34 | Schlage C 6 pin, 0 bitted 34 rim cylinder | \$89.00 |
| SE | 34 | Schlage E 6 pin, 0 bitted 34 rim cylinder | |

SARGENT hardware use SARGENT cylinders. SARGENT offers some competitor's keyways for use on certain SARGENT Hardware. These keyways are broached in barrels that are designed to operate in cylinders specific to SARGENT hardware. Note: All competitor keyway cylinders are NOT available in Hotel Functions.

CK-18 KESO F1 SECURITY SYSTEM

SARGENT
ASSA ABLOY

USA & Canada Prices Effective June 3, 2019

KESO F1 **KESO F1 codes are tightly controlled by the factory. End users signature required for keys & cylinders. All keying and key cutting is performed in a factory secure area.**

Note: KESO keys are not available Less Logo.

| Keso F1 Security System Variations | | | |
|------------------------------------|--------|---|-----------------------|
| Option | Number | Description | Add to Set Price |
| F1 | 82 | KESO F1 Security Cylinder | \$84.00 per Cylinder |
| F1 | 83 | KESO F1 Security Removable Core Cylinders | \$120.00 per Cylinder |
| | 84 | KESO Security Removable Construction Core Cylinders | See Below |

Above option numbers and price additions apply to 8 Line, 9 Line, 10 Line (82 Option only), Mortise Locks and Exit Devices only. Above price additions include all keying charges. Consult individual product catalog for availability.

| | | |
|------------|---------------------------------------|----------------------|
| Extra Keys | Extra Keys with locksets or cylinders | \$9.00 for extra key |
|------------|---------------------------------------|----------------------|

| Cut Keys | | | |
|----------|---------|--|--------------|
| Option | Number | Description | Price |
| F1 | K372MK | Master Key | |
| F1 | K372CHK | Day Key | |
| F1 | K372CTL | Removable Core Control or Emergency Key for all cylinder locks except 8G50 | \$11.00 Each |
| F1 | K373EMK | Emergency Key Mortise | |
| F1 | K374EMK | Emergency Key for 8G50 | |

KESO F1 cut keys are identified by the key number stamped on the bow of the key.

To place an order for cut keys, please be sure to include this number.

SARGENT will not be responsible for the function of the keys supplied using misidentified KESO F1 key numbers.

Please consult factory, if there are any questions, to verify that the stamp number is on file and to cross reference it to a keyset symbol.

KESO TEMPORARY CONSTRUCTION CORE – Same for KESO F1 and KESO key systems

(84-) The customer will be invoiced at \$60.00 NET/NET per construction core and the full invoice must be paid according to SARGENT's standard terms. No further discount will be applied. When construction cores are to be returned, the distributor must contact Customer Service for an RGA. Once the construction cores are returned to SARGENT, SARGENT will issue a \$58.00 credit for each construction core returned from the specified project.

| Number | Description | Price |
|--------|--------------------------------|---------|
| 355CMK | Construction Day Key (84-) | \$11.00 |
| 355CTL | Construction Control Key (84-) | |

| Visual Key Control | | |
|---|--|------------------|
| Stamping of cylinder concealed and/or two keys with industry standard alpha numeric keyset symbol | | Add \$8.00 /cyl. |
| Each additional key | | \$1.00 /key |

Note: On new master keyed systems, removable and interchangeable core systems, and construction Master keyed system orders, please specify quantity of master keys, control keys, and master construction keys required. If order does not give quantities of key requirements, a minimum of 6 each master keys will be provided on new master keyed orders; 1 each control key will be provided on new removable core or interchangeable core jobs; 6 each construction master keys will be provided for construction keyed orders.

USA & Canada Prices Effective June 3, 2019

| 8 Line, 9 Line & 10 Line - KESO F1 Security Cylinders – For use in locks prepared for KESO F1 | | | | Specify Finish |
|---|--|---|---|----------------|
| Option | Number | Description | | 04/15 |
| F182 | C8-1 | All 8, 9 Line Functions (except 50 Function) | | \$171.00 |
| F182 | C8-2 | 8, 9 Line #50 Function | | \$212.00 |
| F182 | C10-1 | All 7, 10 Line Functions (except 50 Function) | | \$171.00 |
| F182 | C11-1 | All 11 Line Functions (except 50 Function) | | |
| 8 Line & 9 Line - KESO F1 Security Removable Cylinder – For use in locks prepared for KESO | | | | Specify Finish |
| Option | Number | Description | | 04/15 |
| F183 | C8-1 | | | \$207.00 |
| Rim - KESO F1 Security Cylinders | | | | Specify Finish |
| Option | Number | Description | US03/04/09/10/10B/10BE/10BL/20D/26/26D/32/32D/BSP/WSP | |
| F182 | 64 | Rim Cylinder | | \$173.00 |
| Mortise - KESO F1 Security Cylinders | | | | Specify Finish |
| Option | Number | Description | US03/04/09/10/10B/10BE/10BL/20D/32/32D/BSP/WSP | |
| F182 | 71, 72, 73, 74, 76 | Regular cam | | |
| F182 | 72-115, 73-115 | Hotel cam | | \$173.00 |
| F182 | 71-105, 72-105, 73-105, 74-105, 76-105 | Cam for i/s of 78/8216 or 92 functions | | |
| F182 | 71-101 Thru 76-101 | Adams Rite 1850 cam | | |
| F182 | 71-113 Thru 76-113 | Keyswitch cam | | \$173.00 |
| F182 | 71-106 Thru 76-106 | Schlage L cam | | |
| Integra Lock Cylinders | | | | Specify Finish |
| Option | Number | Description | US03/04/09/10/10B/10BE/10BL/20D/32/32D/BSP/WSP | |
| F182 | | C7600-1 | | \$214.00 |
| F183 | | C7600-1 (Removable core) | | \$250.00 |

Note: Mortise & Rim cylinders are available in US3, 4, 9, 10, 10B, 10BE, 10BL, 14, 15, 20D, 32, 32D, BSP, WSP finishes. Cylinder plugs/barrels will be in either US4 or 15. Specify finish when ordering.

KESO F1 keysets are stamped on the cylinders in a concealed location.

For best results when ordering additional cylinders to the same keyset, please provide this stamped keyset on your order.

CK-20 KESO F1 SECURITY SYSTEM

SARGENT®

CYLINDERS

ASSA ABLOY

USA & Canada Prices Effective June 3, 2019

Mortise Cylinders with Removable Cores Only (Not available for hotel functions)

| Option | Number | Description | Specify Finish |
|--------|------------------------------------|--|----------------|
| F183 | 172, 173, 174, 176 | Regular offset cam only | |
| F183 | 172-105, 173-105, 174-105, 176-105 | Short cam (For 8216 & 8292 Lock Functions – Inside Cyl.) | \$209.00 |
| F183 | 172-101 thru 176-101 | Adams Rite cam (MS1850) | \$209.00 |

Removable Core Only – For Mortise Cylinders

| Option | Number | Description | Specify Finish |
|--------|--|--|----------------|
| F1 | 5172, 5173, 5174, 5176 | Regular offset cam | |
| F1 | 5172-105, 5173-105, 5174-105, 5176-105 | Short Cam (For 8216 & 8292 Lock Functions – Inside Cyl.) | \$120.00 |
| F1 | 5172-101 thru 5176-101 | Adams Rite Cam (MS1850) | \$120.00 |

Rim Cylinders with Removable Core

| Option | Number | Description | Specify Finish |
|--------|--------|--------------|----------------|
| F183 | 164 | Rim Cylinder | \$209.00 |

Removable Core Only – For Rim Cylinders

| Option | Number | Description | Specify Finish |
|--------|--------|--------------|----------------|
| F1 | 5164 | Rim Cylinder | \$120.00 |

KESO Cylinder Cams

| Number | Description | Specify Finish |
|---------|--|----------------|
| 13-2563 | For use with SARGENT KESO F1 cylinders 71 thru 76 and 172 thru 176. All functions except 50 | \$4.98 |
| 13-2283 | For use with 50 Lock Function. | \$25.50 |
| 13-2522 | For use on inside cylinder of 78/8216 or 92 Function | \$9.45 |

Note: Mortise & Rim cylinders are available in US3, 4, 9, 10, 10B, 10BE, 10BL, 14, 15, 20D, 32, 32D, BSP, WSP finishes.
Cylinder plugs/barrels will be in either US4 or 15. Specify finish when ordering.
Mortise/Rim Removable Core Cylinder - Housings ONLY, crews and back plate to be ordered separately.

Mortise/Rim Removable Core Cylinder - Housings ONLY, screws and back plate to be ordered separately.

| Number | Description | Price |
|----------------------|----------------------|---------|
| 072, 073, 074, 076 - | Mortise Housing only | \$90.00 |
| *064 - | Rim Housing only | |

* screws (part #13-0074 -2 required) and back plate (part #13-0086) - 1 required)

Removable Construction Core ONLY - for Mortise/Rim Cylinders

| Mortise | Price |
|---|----------|
| 5472, 5473, 5474, 5476 - for Mortise type cylinder | |
| 5472-105, 5473-105, 5474-105, 5476-105 - for Mortise type cylinder x short offset cam | |
| 5472-101, 5473-101, 5474-101, 5476-101 - for Mortise type cylinder x Adams Rite Cam(MS1850) | \$120.00 |
| 5464 - for Rim type cylinder | |

UL LISTED CYLINDERS/CAMS/PADLOCKS

USA & Canada Prices Effective June 3, 2019

| UL Listed KESO F1 Security Cylinders | | | Price |
|--------------------------------------|----------------------------------|--|-----------------|
| Option | Number | Description | 10/26/26D |
| F1 | 4252 | Utility Lock – Flat Cam | \$245.00 |
| F1 | 4252-2 | Utility Lock – Offset Cam | \$245.00 |
| F1 | 4253 | Switch Lock – Available in 26 Finish Only | \$312.00 |
| F1 | 4264 | Rim Cylinder | \$191.00 |
| F1 | 4271, 4272,4273,4274,4276 | Mortise Cylinder | \$191.00 |
| F1 | 4271-106 | | \$214.00 |
| Cam | | | Price |
| Number | Description | | |
| 13-2563 | Regular offset cam | | \$4.98 |
| 13-2283 | Hotel cam (-115) | | \$25.50 |
| 13-2522 | Short offset cam (-105) | | \$9.45 |
| 13-2521 | Adams Rite MS 1850 cam (-101) | | |
| 13-2519 | Key Switch | | \$17.12 |
| 13-0939 | Schlage L cam (-106) | | |
| 16-0129 | 4152 Cam | | \$3.95 |
| 16-0146 | 4152-2 Cam | | \$9.98 |
| Utility Locks | | | Price |
| Option | Number | Description | 03/04/10/26/26D |
| F1 | 4152 | Flat cam | \$223.00 |
| F1 | 4152-2 | Offset cam | |
| Switch Lock | | | Price |
| Option | Number | | 26 |
| F1 | 4153 | | \$290.00 |
| Miscellaneous | | | Price Each |
| | | Qty. Per Bag | |
| 13-0080 | Rim Cylinder Plug Retaining Ring | 25 | \$1.54 |
| 13-0085 | Flat Tail Piece | 25 | |
| Padlocks | | | Specify Finish |
| Option | Number | Description | (04 only) |
| F182 | 856 | Key can be removed while in the unlocked position | |
| F182 | 857 | Key Removable in Locked Position Only | |
| F182 | 856C | Stainless Shackle with 9" chain | |
| F182 | 857C | Key retaining™ Key Removable in Locked Position Only with 9" chain | |
| F182 | 856HS | Hardened Steel Shackle | \$194.00 |
| F182 | 857HS | Hardened Steel Shackle Key Removable in Locked Position Only | |
| F182 | 856HSC | Hardened Steel Shackle with 9" chain | |
| F182 | 857HSC | Hardened Steel Shackle with 9" chain Key Removable in Locked Position Only | |

CYLINDERS

USA & Canada Prices Effective June 3, 2019

Guarantee

The SARGENT KESO F1 Cylinders are guaranteed for a period of one year from date of installation against defective workmanship, material or wear.

This guarantee is based on all items being installed in accordance with templates and installation instructions, and does not include products damaged as a result of misapplication or vandalism.

The following charges will apply for cylinders sent to the Service Center for repair.

| Type of Repair | List Price |
|--------------------------------|-----------------------|
| SARGENT Error | No Charge |
| Pin Wear within 1-yr guarantee | No Charge |
| Pin Wear outside guarantee | Price of new cylinder |
| Field Misuse | Price of new cylinder |

Note: Out of warranty repair requests must be accompanied with a purchase order covering repair charges.

Repair product should be sent via a trackable carrier to:

SARGENT Manufacturing Company
P.O. Box 9725
100 Sargent Drive
New Haven, CT 06536

ATTN: KESO F1 Security Service Center

KESO **KESO codes tightly controlled by the factory, end users signature required for keys & cylinders. All keying and key cutting performed in a factory secure area. Available for existing systems only.**

Note: KESO keys and keyblanks are not available Less Logo.

| Keso Security System Variations | | |
|---------------------------------|---|-----------------------|
| Option | Description | Add to Set Price |
| 82 | KESO Security Cylinder | \$84.00 per Cylinder |
| 83 | KESO Security Removable Core Cylinders | \$120.00 per Cylinder |
| 84 | KESO Security Removable Construction Core Cylinders | See Below |

Above option numbers and price additions apply to 8 Line, 9 Line, 10 Line (82 Option only), Mortise Locks and Exit Devices only. Above price additions include all keying charges.

Extra Keys with locksets or cylinders \$9.00 for extra key

| Cut Keys | | |
|----------|--|--------------|
| Number | Description | Price |
| 372MK | Master Key | |
| 372CHK | Day Key | |
| 372CTL | Removable Core Control or Emergency Key for all cylinder locks except 8G50 | \$11.00 Each |
| 373EMK | Emergency Key | |
| 374EMK | Emergency Key for 8G50 | |

| Keyblanks | | Price | Keys Per Box |
|-----------|----------------------------|-------------|--------------|
| Number | Description | | |
| 375 | Control Keyblank | \$5.00 /ea. | 25 |
| 376 | Master and Change Keyblank | \$5.00 /ea. | 25 |

KESO cut keys are identified by the key number stamped on the bow of the key.

To place an order for cut keys, please be sure to include this number.

SARGENT will not be responsible for the function of the keys supplied using misidentified KESO key numbers.

Please consult factory, if there are any questions, to verify that the stamp number is on file and to cross reference it to a keyset symbol.

KESO TEMPORARY CONSTRUCTION CORE

(84-) The customer will be invoiced at \$60.00 NET/NET per construction core and the full invoice must be paid according to SARGENT's standard terms. No further discount will be applied. When construction cores are to be returned, the distributor must contact Customer Service for an RGA. Once the construction cores are returned to SARGENT, SARGENT will issue a \$58.00 credit for each construction core returned from the specified project.

| Number | Description | Price |
|--------|--------------------------|---------|
| 355CMK | Construction Key | |
| 355CTL | Construction Control Key | \$11.00 |

Note: On new master keyed systems, removable and interchangeable core systems, and construction Master keyed system orders, please specify quantity of master keys, control keys, and master construction keys required. If order does not give quantities of key requirements, a minimum of 6 each master keys will be provided on new master keyed orders; 1 each control key will be provided on new removable core or interchangeable core jobs; 6 each construction master keys will be provided for construction keyed orders.

CK-24 KESO SECURITY SYSTEM

SARGENT®

CYLINDERS

ASSA ABLOY

USA & Canada Prices Effective June 3, 2019

| 8 Line, 9 Line & 10 Line - Keso Security Cylinders – For use in locks prepared for KESO | | | Specify Finish 04/15 |
|---|--|---|----------------------|
| Option | Number | Description | Price |
| 82 | C8-1 | All 8, 9 Line Functions (except 50 Function) | \$171.00 |
| 82 | C8-2 | 8, 9 Line #50 Function | \$212.00 |
| 82 | C10-1 | All 7, 10 Line Functions (except 50 Function) | \$171.00 |
| 82 | C11-1 | All 11 Line Functions (except 50 Function) | \$171.00 |
| 8 Line & 9 Line - Keso Security Removable Cylinder – For use in locks prepared for KESO | | | Specify Finish 04/15 |
| Option | Number | Description | Price |
| 83 | C8-1 | | \$207.00 |
| Rim - Keso Security Cylinders | | US03/04/09/10/10B/10BE/10BL/20D/32/32D/BSP/WSP | |
| Option | Number | Description | Price |
| 82 | 64 | Rim Cylinder | \$173.00 |
| Mortise - Keso Security Cylinders | | US03/04/09/10/10B/10BE/10BL/20D/32/32D/BSP/WSP | |
| Option | Number | Description | Price |
| 82 | 71, 72, 73, 74, 76 | Regular cam | |
| 82 | 72-115, 73-115 | Hotel cam | \$173.00 |
| 82 | 71-105, 72-105, 73-105, 74-105, 76-105 | Cam for i/s of 78/8216 or 92 functions | |
| 82 | 71-101 Thru 76-101 | Adams Rite 1850 cam | \$173.00 |
| 82 | 71-113 Thru 76-113 | Key Switch | \$173.00 |
| 82 | 71-106 Thru 76-106 | Schlage L cam | \$173.00 |
| Integra Lock Cylinders | | 03/04/09/10/10B/10BE/10BL/14/15/20D/26/26D/32/32D/BSP/WSP | |
| Option | Number | Description | Price |
| 82 | C7600-1 | | \$214.00 |
| 83 | C7600-1 | (Removable core) | \$250.00 |

Note: Mortise & Rim cylinders are available in US3, 4, 9, 10, 10B, 10BE, 10BL, 14, 15, 20D, 32, 32D, BSP, WSP finishes. Cylinder plugs/barrels will be in either US4 or 15. Specify finish when ordering.

KESO keysets are stamped on the cylinders in a concealed location.

For best results when ordering additional cylinders to the same keyset, please provide this stamped keyset on your order.

USA & Canada Prices Effective June 3, 2019

| Mortise Cylinders with Removable Cores Only (Not available for hotel functions) | | | |
|--|------------------------------------|--|----------|
| Option | Number | Description | Price |
| 83 | 172, 173, 174, 176 | Regular offset cam only | |
| 83 | 172-105, 173-105, 174-105, 176-105 | Short cam (For 8216 & 8292 Lock Functions – Inside Cyl.) | \$209.00 |
| 83 | 172-101 Thru 176-101 | Adams Rite cam (MS1850) | \$209.00 |

| Removable Core Only – For Mortise Cylinders | | | |
|--|--|--|----------------|
| Option | Number | Description | Price 04/15 |
| | 5172, 5173, 5174, 5176 | Regular offset cam | |
| | 5172-105, 5173-105, 5174-105, 5176-105 | Short Cam (For 8216 & 8292 Lock Functions – Inside Cyl.) | \$120.00 |
| | 5172-101 thru 5176-101 | Adams Rite Cam (MS1850) | \$120.00 |

| Rim Cylinders with Removable Core | | | |
|--|--------|--------------|--|
| Option | Number | Description | Price 03/04/09/10/10B/10BE/10BL/20D/26/26D/32/32D/BSP/WSP |
| 83 | 164 | Rim Cylinder | \$209.00 |

| Removable Core Only – For Rim Cylinders | | | |
|--|--------|--------------|----------------|
| Option | Number | Description | Price 04/15 |
| | 5164 | Rim Cylinder | \$120.00 |

| KESO Cylinder Cams | | | |
|---------------------------|---------|---|---------|
| Option | Number | Description | Price |
| | 13-2563 | For use with SARGENT KESO cylinders 71 thru 76 and 72 thru 176. All functions except 50 | \$4.98 |
| | 13-2283 | For use with 50 Lock Function. | \$25.50 |
| | 13-2522 | For use on inside cylinder of 78/8216 or 92 Lock Function | \$9.45 |

| Mortise/Rim Removable Core Cylinder - Housings ONLY | | | |
|--|----------------------|----------------------|---------|
| Option | Number | Description | Price |
| | 072, 073, 074, 076 - | Mortise Housing only | |
| | *064 - | Rim Housing only | \$90.00 |

* screws (part #13-0074 -2 required) and back plate (part #13-0086) - 1 required)

| Removable Construction Core ONLY - for Mortise/Rim Cylinders | | | |
|---|--|--|----------|
| Mortise | Number | Description | Price |
| | 5472, 5473, 5474, 5476 - | for Mortise type cylinder | |
| | 5472-105, 5473-105, 5474-105, 5476-105 - | for Mortise type cylinder x short offset cam | \$120.00 |
| | 5472-101, 5473-101, 5474-101, 5476-101 - | for Mortise type cylinder x Adams Rite Cam(MS1850) | |
| | 5464 - | for Rim type cylinder | |

Note: Mortise & Rim cylinders are available in US3, 4, 9, 10, 10B, 10BE, 10BL, 14, 15, 20D, 32, 32D, BSP, WSP finishes. Cylinder plugs/barrels will be in either US4 or 15. Specify finish when ordering.

CK-26 KESO SECURITY SYSTEM

SARGENT®

UL LISTED CYLINDERS/CAMS/PADLOCKS

ASSA ABLOY

USA & Canada Prices Effective June 3, 2019

| UL Listed Keso Security Cylinders | | | Price |
|---|--|--|------------|
| Option Number | Description | 10/26/26D | |
| 4252 | Utility Lock – Flat Cam | \$245.00 | |
| 4252-2 | Utility Lock – Offset Cam | \$245.00 | |
| 4253 | Switch Lock – Available in 26 Finish Only | \$312.00 | |
| 4264 | Rim Cylinder | \$191.00 | |
| 4271, 4272,4273,4274,4276 | Mortise Cylinder | \$191.00 | |
| 4271-106 | | \$214.00 | |
| Cam | | | Price |
| Number | Description | | |
| 13-2563 | Regular Offset Cam | \$4.98 | |
| 13-2283 | Hotel Cam (-115) | \$25.50 | |
| 13-2522 | Short Offset Cam (-105) | \$9.45 | |
| 13-2521 | Adams Rite MS 1850 Cam (-101) | | |
| 13-2519 | Key Switch Clover Leaf Cam for 4370 Series | \$17.12 | |
| 13-0939 | Schlage L Cam (-106) | | |
| 16-0129 | 4152 Cam | \$3.95 | |
| 16-0146 | 4152-2 Cam | \$9.98 | |
| Utility Locks | | | |
| Option Number | Description | 03/04/10/26/26D | |
| 4152 | Flat cam | | |
| 4152-2 | Offset cam | \$223.00 | |
| Switch Lock | | | 26 |
| 4153 | | \$290.00 | |
| Miscellaneous | | Qty. Per Bag | Price Each |
| 13-0080 | Rim Cylinder Plug Retaining Ring | 25 | |
| 13-0085 | Flat Tail Piece | 25 | \$1.54 |
| Padlocks | | | Finish |
| 1" Shackle Standard, For 2.5", add -2 as suffix, For 4", add -4 as suffix | | | (04 Only) |
| Option | Number | | |
| 82 | 856 | Key can be removed while in the unlocked position | |
| 82 | 857 | Key Removable in Locked Position Only | |
| 82 | 856C | Stainless Shackle with 9" chain | |
| 82 | 857C | "Key retaining" Key Removable in Locked Position Only with 9" chain | |
| 82 | 856HS | Hardened Steel Shackle | \$194.00 |
| 82 | 857HS | Hardened Steel Shackle Key Removable in Locked Position Only | |
| 82 | 856HSC | Hardened Steel Shackle with 9" chain | |
| 82 | 857HSC | Hardened Steel Shackle with 9" chain Key Removable in Locked Position Only | |

Guarantee

The SARGENT KESO Cylinders are guaranteed for a period of one year from date of installation against defective workmanship, material or wear.

This guarantee is based on all items being installed in accordance with templates and installation instructions, and does not include products damaged as a result of misapplication or vandalism.

The following charges will apply for cylinders sent to the Service Center for repair.

| Type of Repair | List Price |
|--------------------------------|-----------------------|
| SARGENT Error | No Charge |
| Pin Wear within 1-yr guarantee | No Charge |
| Pin Wear outside guarantee | Price of new cylinder |
| Field Misuse | Price of new cylinder |

Note: Out of warranty repair requests must be accompanied with a purchase order covering repair charges.

Repair product should be sent ADD to :

SARGENT Manufacturing Company
P.O. Box 9725
100 Sargent Drive
New Haven, CT 06536

ATTN: KESO Security Service Center

CYLINDERS & KEYING

USA & Canada Prices Effective June 3, 2019

Signature cylinders have the Signature Quill Logo embossed on the face of the cylinder barrel. Signature keys have SARGENT embossed on one side and the Signature Quill Logo, specific Signature code pattern and one additional line for stamping. Key blanks are also available blank one side. Consult the Signature catalog for more specific details. Please contact the factory for keyways available.

Please Note:

Signature products require a special ordering procedure. Please be sure that you include the following information when you send your order to Sargent for processing:

1. Keying Cover Sheet
2. Signature Cover Sheet with complete end user information and distributor information
3. Pin Coded/Letter of authorization from end user

Missing or incomplete information will cause delay in processing and may result in the return of your order. Forms may be obtained by contacting Sargent Customer Service at (800) 727-5477.

| Signature Option (To be added to all applicable products, except where noted) | Price |
|--|------------------|
| 10- Signature System* | Add \$58.00 /cyl |

| Keying Charges & Substitutions | |
|---|-------------------|
| Masterkeying charge is included in price of Removable Core cylinder (Option 10-63-) | |
| Double cylinder locks - Double below charges when purchased with locksets or exit devices | |
| Masterkeying or Higher level of keying, any quantity | Add \$16.00 /cyl. |
| Masterkeying or Higher level of keying, any quantity, cylinders only | |
| Construction Masterkeying with lockset or exit devices (Option 21-) | |
| Construction Masterkeying with lockset or exit devices, cylinders only (Option 21-) | |

| Keys | | |
|---------------|---------------|---------------------------------|
| Option | Number | Description |
| 10 | S6272MK | Masterkey and/or Grandmasterkey |
| 10 | S6272CMK | Construction Masterkey |
| 10 | S6272CTL | Control Key – 6 Pin |
| 10 | S6272CHK | Change (Day) Key – 6 Pin |
| | | \$12.00 /key |

| Extra Keys (Cylinders are packed standard with 2 keys each) | |
|---|------------------|
| For each extra day key ordered with lockset, exit device or cylinder | \$9.00 /key |
| Keys packed separately (indicate appropriate "Ship To" address on keying cover sheet) | Add \$3.00 /cyl. |

| Keyblanks 50 Keys/Box. Must order multiple of 50 keys. | |
|--|--------------|
| Composite master sections 6 Pin 10-S6270 | \$6.40 / key |
| Composite master sections 6 Pin 10-S6270 Unpublished restricted | \$7.30 / key |
| Single change/day sections 6 Pin 10-S6275 | \$6.40 / key |
| Single change/day sections 6 Pin 10-S6275 Unpublished restricted | \$7.30 / key |

| Key Marking (Special marking is limited to space on blank side of keyblank) | |
|--|-------------------|
| Stamping letters or numerals on key bow - add per each letter or numeral | Add \$1.00 /num |
| "Do Not Duplicate" or other stamps on file at Sargent | No Addition |
| Where new special stamping is required i.e., "State of Alaska - Do Not Duplicate" | Add \$840.00 /die |
| Keys stamped from this special die on first order only | Add \$4.00 /key |

| Visual Key Control (When ordered with non-Signature product, the following applies to all) | |
|---|------------|
| Signature Keys include visual key control (keys are stamped, cylinder face can not be stamped) | N/C |
| Non-Signature product requiring visual key control when ordered with Signature product | See CK-3 |
| Concealed stamping of Rim or Mortise slide | Add \$8.00 |
| Concealed stamping of 10-6300 slide | Add \$8.00 |

| Delete SARGENT Logo | |
|---|--|
| To delete SARGENT Logo from Keys – N/A for IC, XC, KESO | Consult factory for additional cost and leadtime |
| To delete SARGENT Logo from Extra Keys | |
| To delete SARGENT Logo from SARGENT Mortise & Rim Cylinders | |

*Note: Available in the following Sargent keyway families – L, R
Refer to CK-3 for pricing and prior authorization requirements.



USA & Canada Prices Effective June 3, 2019

Note: Mortise & Rim cylinders are available in US3, 4, 9, 10, 10B, 10BE, 10BL, 20D, 32, 32D, BSP, WSP finishes.
Cylinder plugs/barrels will be in either US4 or 15. Specify finish when ordering.

| Removable Core Cylinder (The Signature option add has already been included) | | Price |
|--|------------|----------------|
| Number | | Specify Finish |
| 10-6334, 10-6342, 10-6343, 10-6344, 10-6346 | 6 Pin only | \$224.00 |

| Removable Cores Only (The Signature option add has already been included) | | Price |
|---|----------------------------|----------------|
| Assembled | | Specify Finish |
| 10-6300 | For All Except 50 Function | \$135.00 |

NOTE: 65- unassembled is not available with Signature cores. Available 1-bitted only.

| *Mortise Cylinders with following Cams | | Price |
|--|--|-------------|
| 101 | For Adams Rite – 1850, 4700 | |
| 105 | Sargent Short Cam - for inside of 78/8216 & 92 functions | |
| 106 | For Schlage L | No Addition |
| 112 | “Open” Misc. Wide Straight Cam | |
| 113 | For 4370 Key Switch | |

* Cams must be ordered with cylinders – permanently attached at the factory

Note: Construction Cores are available. Refer to CK-2 for Policy & Pricing. If ordering in “C” or “H” and or “G” keyway family, please consult factory.

| Parts | | Price |
|---------|---|----------|
| 13-0985 | Blocking Bar (Old Style) | \$6.98 |
| 13-1109 | Blocking Bar (New Style) | \$18.12 |
| 13-0986 | Blocking Bar Spring | \$0.09 |
| 13-0977 | Body for 10-6300 | \$37.19 |
| 13-0797 | Slide for 6300 made before 3/06 with box logo (Price/pack - 100 slides) | \$39.46 |
| 13-0976 | Barrel for 10-6300 | \$94.37 |
| 13-1074 | Sleeve for 6300 & 10-6300 | \$0.65 |
| 13-1341 | Slide for 6300 made after 3/06 (Price/pack - 100 slides) | \$39.46 |
| 437S | Signature Re-keying Kit | \$854.00 |
| 437RC | Re-keying Kit (Conventional & Signature) for removable Cores used in factory master keyed cylinders before January 2009 | \$401.00 |
| 13-1037 | Loading Rod Blade (Signature) | \$13.92 |
| 13-1138 | Loading Rod Blade (Signature) | \$13.92 |
| 18-0070 | Cylinder Spray Lube | \$26.59 |
| 18-0435 | Cylinder Cleaner/De-Icer | \$26.59 |

| Signature Cylinder Pins (Optional for 437RC kit) | | |
|--|----------|-----------|
| Stainless Steel pins for Protected Signature Cylinders | | |
| Price/Pack | | |
| Part. No. | Size | (25 Pins) |
| 13-1210 | 1 | |
| 13-1211 | 2 | |
| 13-1212 | 3 | |
| 13-1213 | 4 | \$87.00 |
| 13-1214 | 5 | (Order in |
| 13-1215 | 6 | multiples |
| 13-1216 | 7 | of 25) |
| 13-1217 | 8 | |
| 13-1218 | 9 | |
| 13-1222 | B-Driver | |
| 13-1223 | C-Driver | |

| For Sargent 6300 Removable Core & Signature | | |
|---|------------|------------|
| Removable Core—for 3rd & 4th positions: | Price/Pack | |
| Part. No. Hollow Drivers | Size | (100 Pins) |
| 13-1229 | 3 | \$45.00 |
| 13-1234 | 4 | |
| 13-1235 | 5 | \$25.00 |
| 13-1236 | 6 | (Order in |
| 13-1237 | 7 | multiples |
| 13-1238 | 8 | of 100) |
| 13-1239 | 9 | |
| 13-1240 | 10 | |

| For Sargent 6300 Removable Core & Signature | | Price/Pack |
|---|---|-------------|
| Removable Core—Parts: | | (100 rings) |
| Part. No. Miscellaneous | | |
| 13-0487 | Hollow Driver Springs used in the 3rd and 4th chambers of factory keyed cores prior to 1/1/09 | \$87.55 |
| 01-0660 | Retaining Ring | \$87.55 |

MORTISE & RIM CYLINDERS

ASSA ABLOY

USA & Canada Prices Effective June 3, 2019

Note: Mortise & Rim cylinders are available in US3, 4, 9, 10, 10B, 10BE, 10BL, 20D, 32, 32D, BSP, WSP finishes.
 Cylinder plugs/barrels will be in either US4 or 15. Specify finish when ordering.

| Mortise Cylinder 6 Pin(The Signature add is included) | | |
|--|----------------|----------|
| Number | Specify Finish | Price |
| 10-41, 10-42, 10-43, 10-44, 10-46 | | \$147.00 |
| 10-48, 10-50, 10-52, 10-54 | | \$188.00 |
| 10-56 | | \$377.00 |

Note: Price does not include Masterkeying

| Mortise Cylinders with following: | | |
|--|-----------------------------------|-------------|
| Cam No. | | Price |
| 101 | For Adams Rite 1850, 4700 | |
| 106* | For Schlage "L" | No Addition |
| 112 | "Open" Misc. - Wide Straight Cam | |
| 113 | For 4370 Key Switch Coverleaf Cam | |

| Mortise Cylinder (10-40 Series) Plug & Sidepin | | |
|---|----------------|----------|
| Ass'y | Specify Finish | Price |
| 13-3835 | 41 | |
| 13-3836 | 42 | |
| 13-3837 | 43 | \$102.29 |
| 13-3838 | 44 | |
| 13-3839 | 46 | |
| 13-3840 | 48 | |
| 13-3841 | 50 | |
| 13-3842 | 52 | \$120.92 |
| 13-3843 | 54 | |
| 13-3844 | 56 | |

| Mortise Cylinder(10-40 Series) Bodies | | | |
|--|----------------|--|---------|
| Number | Specify Finish | | Price |
| 13-3726 | 41 | | |
| 13-3727 | 42 | | |
| 13-3728 | 43 | | \$55.23 |
| 13-3729 | 44 | | |
| 13-3730 | 46 | | |
| 13-3731 | 48 | | |
| 13-3732 | 50 | | |
| 13-3733 | 52 | | \$79.61 |
| 13-3734 | 54 | | |
| 13-3735 | 56 | | |

| Rim Cylinder | Price |
|---------------------|--------------|
| 10-34 | \$147.00 |

Note: Price does not include Masterkeying

| Rim Cylinder (10-34 Series) Plug & Sidepin Ass'y | | |
|---|-------|----------|
| Specify Finish | | Price |
| 13-3845 | 6 Pin | \$102.29 |

Note: Price does not include Masterkeying

| Rim Cylinder (10-34 Series) Cylinder Body | | |
|--|-------|---------|
| Specify Finish | | Price |
| 13-3847 | 6 Pin | \$50.58 |

| 11 Line Cylinder Assemblies | | | |
|--|--------------------------------------|--|----------|
| Option | Number | Specify Finish US4 or 15 | Price |
| 10 | C11-1 | For all Except 50 Function | \$145.00 |
| 10, 8L, 7L, 6500 Lever Cylinder Assemblies | | | |
| Option | Number | Specify Finish US4 or 15 | Price |
| 10 | C10-1 | For all Except 50 Function | \$145.00 |
| 8, 9 Knob Line Cylinder Assemblies | | | |
| Option | Number | Specify Finish US4 or 15 | Price |
| 10 | C8-1 | For all Except 50 Function | \$145.00 |
| 8X Knob Line Cylinder Assemblies | | | |
| Option | Number | Specify Finish US4 or 15 | Price |
| 10 | C8X-1 | For all Except 50 Function | \$145.00 |
| 6 Line Cylinder Assemblies | | | |
| Option | Number | Specify Finish US4 or 15 | Price |
| 10 | C6-1 | 6 Pin (S and N Knobs) For All Except 50 Function | \$145.00 |
| 10 | C6-1B | 6 Pin (B Knob) For All Except 50 Function | |
| Auxiliary Locks Cylinder Assemblies | | | |
| Option | Number | Specify Finish US4 or 15 | Price |
| 10 | C480-1 | 474, 484 | \$145.00 |
| 10 | C480-2 | 485, 487 | |
| 10 | C480-3 | 475, 486 | |
| 10 | C460-1 | 464 | |
| 10 | C460-2 | 465 | |
| 10 | C750-1 | 758, 858 | |
| Note: Above Cylinder Assembly prices do not include masterkeying. | | | |
| 7600 Integrallock Cylinders (All functions except 26, 27, and 50) | | | |
| Option | Part # | Specify Finish US4 or 15 | Price |
| 10 | *C7600-1 | Signature | \$188.00 |
| 10-21 | *C7600-1 | Construction & Signature | \$220.00 |
| Bored Lock Cylinder Plug & Sidepin Assemblies | | | |
| Plug No. | Specify Finish US4 or 15 | | Price |
| 13-3851 | For 8L, 10, 11, 6500, 6L Lever Lines | | \$102.29 |
| 13-3850 | For 8, 9 Knob Lines | | |
| 13-3849 | For 460, 480 Series | | |
| Bored Lock Cylinder Body | | | |
| Cyl. Body No. | | | Price |
| 13-3710 | For 6L, 8L, 10, 11, 6500 Lever Lines | | \$51.15 |
| 13-3852 | For 8, 9 Knob Lines | | |
| 13-3854 | For 460/480 Series | | |

CK-34 CYLINDERS & KEYING

SARGENT®

ASSA ABLOY

DEGREE KEY SYSTEM DG1 LARGE FORMAT IC CORE RIM & MORTISE CYLS. DG2 MORTISE & RIM CYLINDERS

USA & Canada Prices Effective June 3, 2019

Degree DG1 Large Format Interchangeable Core Cylinders

Note: Mortise & Rim cylinder housings include #97 Rossette are available in the following finishes: 3, 4, 9, 10, 10B, 10BE, 10BL, 14, 15, 20D 26, 26D, BSP, WSP. Bored Cylinder Assemblies, cylinder plugs/barrels are available in the following finishes: 4, 15.

| DG1-6300 Series Large Format Interchangeable Core (LFIC) Cylinders | | |
|--|---|-------------|
| Option | Description | Price |
| DG1-60 | Degree DG1 Large Format Interchangeable Plastic Disposable Construction Core | No addition |
| DG1-63 | Degree DG1 Large Format Interchangeable Core Cylinder - includes masterkeying charges | \$77.00 |
| DG1-64 | Degree DG1 Large Format Interchangeable Construction Core Cylinder | \$77.00 |

Note: Price includes Masterkeying

| Cut Master Keys | | |
|-----------------|-----------|-------------|
| Options | Number | Description |
| DG1 | DG6272CTL | Control key |
| DG1 | DG6272MK | Masterkey |

\$9.00

| Degree DG1 LFIC Mortise & Rim Cylinders - Includes Master & Grand Master Keying Charges | Specify Finish Price |
|---|---------------------------------------|
| Number | Cylinder Size |
| DG1-63 | 34, 42, 43, 44, & 46 - 6 Pin Only |
| DG1-63-50 | 43 & 44 - Hotel type Mortise cylinder |

\$166.00
\$195.00

| Degree DG1 LFIC ONLY - Includes Master & Grand Master Keying Charges | Specify Finish Price |
|--|----------------------|
| Number | Cylinder Size |
| DG1-6300 | 6-Pin only |

\$77.00

| Degree DG1 LFIC ONLY - Unassembled | Specify Finish Price |
|------------------------------------|----------------------|
| Number | Cylinder Size |
| DG1-65-6300 | 6-Pin only |

\$67.00

| Degree DG1 LFIC Mortise & Rim body only | Specify Finish Price |
|---|---------------------------------------|
| Number | Cylinder Size |
| DG1-60 | 34, 42, 43, 44, & 46 - 6 Pin Only |
| DG1-60-50 | 43 & 44 - Hotel type Mortise cylinder |

\$89.00
\$118.00

| *Cylinders with following Cams | | |
|--------------------------------|--|-------------|
| Cam No. | Description | |
| 101 | For Adams Rite 1850, 4700 | No Addition |
| 105 | Sargent Short Cams I/S 78/82 (16 & 92) functions | |
| 106 | For Schlage "L" | |
| 113 | For 4370 Key Switch Coverleaf Cam | |
| 112 | "Open" Misc. – Wide Straight Cam | |

Note: *Cams must be ordered with cylinders – permanently attached at the factory.

| DG2 Rim and Mortise Cylinder 6 Pin | | |
|------------------------------------|------------------------------|----------|
| Option | Specify finish when ordering | Price |
| DG2 | 34 | \$147.00 |
| DG2 | 41, 42, 43, 44, 46 | |

Note: Price does not include Masterkeying

| Mortise Cylinders with following suffix cam no. | | |
|---|--|-------------|
| Cam No. | Description | |
| 101 | For Adams Rite 1850, 4700 | No Addition |
| 105 | Sargent Short Cams I/S 78/82/16/92 functions | |
| 106 | For Schlage "L" | |
| 113 | For 4370 Key Switch Coverleaf Cam | |
| 112 | "Open" Misc. – Wide Straight Cam | |

| Degree Series Mortise Cylinder Exposed Barrel Only | | |
|--|------------|----------------------|
| Number | Size | Specify Finish Price |
| DG2-78 | 41, 42, 43 | \$176.00 |

DEGREE™ KEY SYSTEM DG1 MORTISE, RIM, BORED LOCK, DEADBOLTS, INTEGRALOCK, AND PADLOCK CYLINDERS

USA & Canada Prices Effective June 3, 2019

Note: Mortise & Rim cylinder housings include #97 Rossette are available in the following finishes: 3, 4, 9, 10, 10B, 10BE, 10BL, 14, 15, 20D, 26, 26D, BSP, WSP. Bored Cylinder Assemblies, cylinder plugs/barrels are available in the following finishes: 4, 15.

| DG1 Rim and Mortise Cylinder 6 Pin | | |
|------------------------------------|------------------------------|---------|
| Option | Specify finish when ordering | Price |
| DG1 | 34 | \$89.00 |
| DG1 | 41, 42, 43, 44, 46 | \$89.00 |

Note: Price does not include Masterkeying

| Mortise Cylinders with following suffix cam number | | |
|--|--|-------------|
| 101 | For Adams Rite 1850, 4700 | No Addition |
| 105 | Sargent Short Cams I/S 78/82/16/92 functions | |
| 106 | For Schlage "L" | |
| 113 | For 4370 Key Switch Coverleaf Cam | |
| 112 | "Open" Misc. – Wide Straight Cam | |

| DG1 Hotel Type Mortise Cylinders – Consult Factory for existing system compatibility | | Price |
|--|--|----------|
| DG1 50-43/50-44 | Hotel Cylinder (7850, 7950, 8250 only) | \$118.00 |

| Degree Series Mortise Cylinders, Exposed Barrel Only | | Specify Finish When Ordering Price |
|--|------------|------------------------------------|
| DG1-78 | 42, 43, 44 | \$118.00 |

| T-Zone (11Line) and 10L Cylinder Assemblies | | | |
|---|--------|--|----------|
| Option | Number | Description | Price |
| *DG1 | C11-1 | T-Zone cylinder - all functions except 50 function | \$87.00 |
| *DG1 | C11-2 | 11 Line 50 function | \$128.00 |
| *DG1 | C10-1 | 10, 7L, & 6500 lever lock cylinder- all functions except 50 function | \$87.00 |
| *DG1 | C10-2 | 10 Line 50 function | \$105.00 |

| 7L, 8L, 8XL & 9L Knob Lock Cylinder Assemblies and Components | | | |
|---|-------|---|----------|
| *DG1 | C8-1 | 7, 8, 9 Knob Locks - all functions except 50 function | \$87.00 |
| *DG1 | C8-2 | 8L Knob Locks - 50 function | \$128.00 |
| DG1 | C8X-1 | 8X Knob Lock - All except 50 function | \$87.00 |

| 6L Knob Lock Cylinder Assemblies and Components | | | |
|---|-------|---|---------|
| *DG1 | C6-1 | 6 Line knob lock (S & N knobs) - all functions except 50 function | \$87.00 |
| *DG1 | C6-1B | 6L Knob Lock cylinder (B knob) - all functions except 50 function | |

| 460/470/480 Cylinder Assemblies and Components | | | |
|--|--------|-------------------|---------|
| DG1 | C460-1 | 464 cylinder | \$87.00 |
| DG1 | C460-2 | 465 cylinder | |
| DG1 | C480-1 | 474, 484 cylinder | |
| DG1 | C480-2 | 485, 487 | |
| DG1 | C480-3 | 475, 486 cylinder | |

| 7600 Integralock Cylinder Assemblies and Components | | | |
|---|---------|-------------------------------------|----------|
| *DG1 | C7600-1 | 7600 Integra functions 04, 05, & 37 | \$130.00 |

| 758/858 Padlock Cylinder Assemblies and Components | | | |
|--|--------|-------------------|---------|
| *DG1 | C750-1 | 758, 858 cylinder | \$87.00 |

CK-34 CYLINDERS & KEYING

SARGENT®

ASSA ABLOY

DEGREE KEY SYSTEM DG1 LARGE FORMAT IC CORE RIM & MORTISE CYLS. DG2 MORTISE & RIM CYLINDERS

USA & Canada Prices Effective June 3, 2019

Degree DG1 Large Format Interchangeable Core Cylinders

Note: Mortise & Rim cylinder housings include #97 Rossette are available in the following finishes: 3, 4, 9, 10, 10B, 10BE, 10BL, 14, 15, 20D 26, 26D, BSP, WSP. Bored Cylinder Assemblies, cylinder plugs/barrels are available in the following finishes: 4, 15.

| DG1-6300 Series Large Format Interchangeable Core (LFIC) Cylinders | | |
|--|---|-------------|
| Option | Description | Price |
| DG1-60 | Degree DG1 Large Format Interchangeable Plastic Disposable Construction Core | No addition |
| DG1-63 | Degree DG1 Large Format Interchangeable Core Cylinder - includes masterkeying charges | \$77.00 |
| DG1-64 | Degree DG1 Large Format Interchangeable Construction Core Cylinder | \$77.00 |

Note: Price includes Masterkeying

| Cut Master Keys | | | |
|-----------------|-----------|-------------|------------|
| Options | Number | Description | Price Each |
| DG1 | DG6272CTL | Control key | \$9.00 |
| DG1 | DG6272MK | Masterkey | |

| Degree DG1 LFIC Mortise & Rim Cylinders - Includes Master & Grand Master Keying Charges | Specify Finish Price | |
|---|---------------------------------------|----------|
| Number | Cylinder Size | |
| DG1-63 | 34, 42, 43, 44, & 46 - 6 Pin Only | \$166.00 |
| DG1-63-50 | 43 & 44 - Hotel type Mortise cylinder | \$195.00 |

| Degree DG1 LFIC ONLY - Includes Master & Grand Master Keying Charges | Specify Finish Price | |
|--|----------------------|---------|
| Number | Cylinder Size | |
| DG1-6300 | 6-Pin only | \$77.00 |

| Degree DG1 LFIC ONLY - Unassembled | Specify Finish Price | |
|------------------------------------|----------------------|---------|
| Number | Cylinder Size | |
| DG1-65-6300 | 6-Pin only | \$57.00 |

| Degree DG1 LFIC Mortise & Rim body only | Specify Finish Price | |
|---|---------------------------------------|----------|
| Number | Cylinder Size | |
| DG1-60 | 34, 42, 43, 44, & 46 - 6 Pin Only | \$89.00 |
| DG1-60-50 | 43 & 44 - Hotel type Mortise cylinder | \$118.00 |

| *Cylinders with following Cams | | |
|--------------------------------|--|-------------|
| Cam No. | Description | |
| 101 | For Adams Rite 1850, 4700 | No Addition |
| 105 | Sargent Short Cams I/S 78/82 (16 & 92) functions | |
| 106 | For Schlage "L" | |
| 113 | For 4370 Key Switch Coverleaf Cam | |
| 112 | "Open" Misc. - Wide Straight Cam | |

Note: *Cams must be ordered with cylinders - permanently attached at the factory.

| DG2 Rim and Mortise Cylinder 6 Pin | | |
|------------------------------------|------------------------------|----------|
| Option | Specify finish when ordering | Price |
| DG2 | 34 | \$147.00 |
| DG2 | 41, 42, 43, 44, 46 | |

Note: Price does not include Masterkeying

| Mortise Cylinders with following suffix cam no. | | |
|---|--|-------------|
| Cam No. | Description | |
| 101 | For Adams Rite 1850, 4700 | No Addition |
| 105 | Sargent Short Cams I/S 78/82/16/92 functions | |
| 106 | For Schlage "L" | |
| 113 | For 4370 Key Switch Coverleaf Cam | |
| 112 | "Open" Misc. - Wide Straight Cam | |

| Degree Series Mortise Cylinder Exposed Barrel Only | | |
|--|------------|----------------------|
| Number | Size | Specify Finish Price |
| DG2-78 | 41, 42, 43 | \$176.00 |

DEGREE KEY SYSTEM DG2 BORED LOCK, DEADBOLTS, INTEGRALOCK, AND PADLOCK CYLINDERS DG2 LARGE FORMAT IC CORE CYLINDERS

USA & Canada Prices Effective June 3, 2019

| DG2 Degree Level T-Zone (11 Line), 10L, 8L, 7L, 6L, 6500 Lever Lock Cylinder Assemblies and Components | | Specify Finish Price |
|---|-------------|----------------------------|
| Option | Description | |

| | | |
|-----------|--|----------|
| DG2 C11-1 | T-Zone cylinder - all functions except 50 function | \$145.00 |
| DG2 C10-1 | 10, 8L, 7L, 6500 lever lock cylinder- all functions except 50 function | |

| 7L, 8L, & 9L Knob Lock Cylinder Assemblies and Components | | Price |
|---|-------------|-------|
| Option | Description | |

| | | |
|-----------|--|----------|
| DG2 C8-1 | 7, 8, 9 Knob Locks - all functions except 50 function" | \$145.00 |
| DG2 C8X-1 | Cylinder – 8X Knob Locks | |

| 6L Knob Lock Cylinder Assemblies and Components | | Price |
|---|-------------|-------|
| Option | Description | |

| | | |
|-----------|---|----------|
| DG2 C6-1 | 6 Line knob lock (S & N knobs) - all functions except 50 function | \$145.00 |
| DG2 C6-1B | 6L Knob Lock cylinder (B knob) - all functions except 50 function | |

| 460/470/480 Cylinder Assemblies and Components | | Specify Finish Price | 7600 Integralock Cylinder Assemblies and Components | | Specify Finish Price |
|--|-------------|----------------------------|---|------|----------------------------|
| Number | Description | | Number | Size | |

| | | | | | |
|------------|--------------|----------|-------------|-------------------------------------|----------|
| DG2 C460-1 | 464 cylinder | \$145.00 | DG2 C7600-1 | 7600 Integra functions 04, 05, & 37 | \$188.00 |
|------------|--------------|----------|-------------|-------------------------------------|----------|

DG2 C460-2 465 cylinder

DG2 C480-1 474, 484 cylinder

DG2 C480-2 485, 487 cylinder

DG2 C480-3 475, 486 cylinder"

| 758/858 Padlock Cylinder Assemblies and Components | | Specify Finish Price |
|--|------|----------------------------|
| Number | Size | |

DG2 C750-1 758, 858 cylinder \$145.00

| DG2-6300 Series Large Format Interchangeable Core (LFIC) Cylinders | | Price |
|--|-------------|-------|
| Option | Description | |

DG2-60 Degree DG2 Large Format Interchangeable Plastic Disposable Construction Core No Addition

DG2-63 Degree DG2 Large Format Interchangeable Core Cylinder - includes masterkeying charges \$135.00

DG2-64 Degree DG2 Large Format Interchangeable Construction Core Cylinder \$77.00

Note: Price includes Masterkeying

| Cut Master Keys | | Price Each |
|-----------------|--------|-------------|
| Options | Number | Description |

DG2 DS6272CTL Control key \$17.00

DG2 DS6272MK Masterkey

| Degree DG2 LFIC Mortise & Rim Cylinders - Includes Master & Grand Master Keying Charges | | Specify Finish Price |
|---|---------------|-------------------------|
| Number | Cylinder Size | |

DG2-63 34, 42, 43, 44, & 46 - 6 Pin Only \$224.00

| Degree DG2 LFIC ONLY - Includes Master & Grand Master Keying Charges | | Specify Finish Price |
|--|---------------|-------------------------|
| Number | Cylinder Size | |

DG2-6300 6-Pin only \$135.00

| Degree DG2 LFIC ONLY - Unassembled | | Specify Finish Price |
|------------------------------------|---------------|-------------------------|
| Number | Cylinder Size | |

DG2-65-6300 6-Pin only \$125.00

| Degree DG2 LFIC Mortise & Rim body only - Includes Master & Grand Master Keying Charges | | Specify Finish Price |
|---|---------------|-------------------------|
| Option Number | Cylinder Size | |

DG2-60 34, 42, 43, 44, & 46 - 6 Pin Only \$89.00

| *Cylinders with following Cams | | |
|--------------------------------|--|--|
|--------------------------------|--|--|

101 For Adams Rite 1850, 4700

105 Sargent Short Cams I/S 78/82 (16 & 92) functions

106 For Schlage "L"

113 For 4370 Key Switch Coverleaf Cam

112 "Open" Misc. – Wide Straight Cam

115 Sargent Removable (63-) Hotel (50-) Cam for 50-60/63-40 series cylinders

No Addition

Note: *Cams must be ordered with cylinders – permanently attached at the factory.

CK-36 CYLINDERS & KEYING

SARGENT®

ASSA ABLOY

DEGREE KEY SYSTEM DG3 MORTISE, RIM AND BORED LOCK, D.BOLTS, INTEGRALOCK, AND PADLOCK CYLINDERS

USA & Canada Prices Effective June 3, 2019

Note: Mortise & Rim cylinder housings include #97 Rosette are available in the following finishes: 3, 4, 9, 10, 10B, 10BE, 10BL, 14, 15, 20D, 26, 26D, BSP, WSP. Bored Cylinder Assemblies, cylinder plugs/barrels are available in the following finishes: 4, 15.

| Rim and Mortise Cylinder 6 Pin | | Price |
|--------------------------------|------------------------------|----------|
| Option | Specify finish when ordering | |
| DG3 | 34 | \$171.00 |
| DG3 | 41, 42, 43, 44, 46 | |

Note: Price does not include Masterkeying

| Mortise Cylinders with following suffix cam no. | | Add/cyl |
|---|--|-------------|
| Cam No. | | |
| 101 | For Adams Rite 1850, 4700 | No Addition |
| 105 | Sargent Short Cams I/S 78/82 (16 & 92) functions | |
| 106 | For Schlage "L" | |
| 113 | For 4370 Key Switch Coverleaf Cam | |
| 112 | "Open" Misc. – Wide Straight Cam | |

| DG3 Degree Level T-Zone (11 Line), 10L, 8L, 7L, 6L, 6500 Lever Lock Cylinder Assemblies and Components | | Specify Finish Price |
|---|--|----------------------|
| Option | Description | |
| DG3 C11-1 | T-Zone cylinder - all functions except 50 function | \$169.00 |
| DG3 C10-1 | 10, 8L, 7L, 6500 lever lock cylinder- all functions except 50 function | |

| 8L, 8X & 9L Knob Lock Cylinder Assemblies and Components | | Specify Finish Price |
|--|---|----------------------|
| Option | Description | |
| DG3 C8-1 | 9, 8L Knob Locks - all functions except 50 function | \$169.00 |
| DG3 C8X-1 | 8X knob lock except 50 function | |

| 6L Knob Lock Cylinder Assemblies and Components | | Specify Finish Price |
|---|---|----------------------|
| Option | Description | |
| DG3 C6-1 | 6 Line knob lock (S & N knobs) - all functions except 50 function | \$169.00 |
| DG3 C6-1B | 6L Knob Lock cylinder (B knob) - all functions except 50 function | |

| 460/470/480 Cylinder Assemblies and Components | | Specify Finish Price | 7600 Integralock Cylinder Assemblies and Components | | Specify Finish Price |
|--|-------------------|----------------------|---|-------------------------------------|----------------------|
| Number | Description | | Number | Size | |
| DG3 C460-1 | 464 cylinder | \$169.00 | DG3 C7600-1 | 7600 Integra functions 04, 05, & 37 | \$212.00 |
| DG3 C460-2 | 465 cylinder | | | | |
| DG3 C480-1 | 474, 484 cylinder | | | | |
| DG3 C480-2 | 485, 487 cylinder | | | | |
| DG3 C480-3 | 475, 486 cylinder | | | | |

DEGREE KEY SYSTEM DG3 LARGE FORMAT IC CORE CYLINDERS

USA & Canada Prices Effective June 3, 2019

| DG3-6300 Series Large Format Interchangeable Core (LFIC) Cylinders | | |
|--|---|-------------|
| Option | Description | Price |
| DG3-60 | Degree DG3 Large Format Interchangeable Plastic Disposable Construction Core | No addition |
| DG3-63 | Degree DG3 Large Format Interchangeable Core Cylinder - includes masterkeying charges | \$159.00 |
| DG3-64 | Degree DG3 Large Format Interchangeable Construction Core Cylinder | \$77.00 |

Note: Price includes Masterkeying
Above options not available with 50 hotel function
DG3 cores must be used with DG3- housings to maintain the UL437 listing

| Cut Master Keys | | | |
|-----------------|--------|-------------|------------|
| Options | Number | Description | Price Each |
| DG3 DS6272CTL | | Control key | \$17.00 |
| DG3 DS6272MK | | Masterkey | |

| Degree DG3 LFIC Mortise & Rim Cylinders - Includes Master & Grand Master Keying Charges | | | Specify Finish Price |
|---|-----------------------------------|--|----------------------|
| Number | Cylinder Size | | |
| DG3-63 | 34, 42, 43, 44, & 46 - 6 Pin Only | | \$248.00 |

| Degree DG3 LFIC ONLY - Includes Master & Grand Master Keying Charges | | | Specify Finish Price |
|--|---------------|--|----------------------|
| Number | Cylinder Size | | |
| DG3-6300 | 6-Pin only | | \$159.00 |

| Degree DG3 LFIC Mortise & Rim body only | | | Specify Finish Price |
|---|-----------------------------------|--|----------------------|
| Option Number | Cylinder Size | | |
| DG3-60 | 34, 42, 43, 44, & 46 - 6 Pin Only | | \$89.00 |

| *Cylinders with following Cams | | | |
|--------------------------------|--|--|-------------|
| 101 | For Adams Rite 1850, 4700 | | No Addition |
| 104 | Adams Rite 4070, 4350, 4250, 4516, 4150 | | |
| 105 | Sargent Short Cams I/S 78/82 (16 & 92) functions | | |
| 106 | For Schlage "L" | | |
| 113 | For 4370 Key Switch Coverleaf Cam | | |
| 112 | "Open" Misc. - Wide Straight Cam | | |

Note: *Cams must be ordered with cylinders – permanently attached at the factory.

| Retrofit Parts/Tail Pieces required with hardware not ordered to accept Degreee Series 6300 core | | |
|--|--|------------|
| 08-5265 | 10-60-63 8 Line Knob Parts Pack | \$39.00 |
| 10-3429 | 10, 7, 6500 Tail Piece & Retainer Pack | \$8.99 |
| 11-5003 | 11 Line "T-Zone" Tail Piece & Retainer Pack | \$8.23 |
| 13-5178 | 11-60-63-34 Rim Cylinder Parts Pack | \$35.01 |
| 16-2508 | 460 Series Cam Assembly | \$3.64 |
| 17-2632 | 758/858 Tail Piece & Retainer Pack | \$10.26 |
| 431-6 | Shear Tool used to modify existing 60- Mortise cylinder housings to accept 11-6300 & DG1, DG2 -6300 series cores | \$417.00 |
| 436-1 | Top Loading Kit | \$670.00 |
| 437DGM | Master Degree Pinning Kit | \$1,371.00 |
| 437DG1 | Degree DG1 Pinning Kit | \$865.00 |

CK-38 CYLINDERS & KEYING

SARGENT®

ASSA ABLOY

DEGREE™ KEY SYSTEM DEGREE PINS AND PARTS

USA & Canada Prices Effective June 3, 2019

| Conical Bottom Pins | | |
|---------------------|------|---------------------|
| Part No. | Size | Price |
| DG-0027 | 0 | |
| DG-0021 | 1 | |
| DG-0022 | 2 | \$17.00 |
| DG-0023 | 3 | (100 pins per pack) |
| DG-0024 | 4 | |
| DG-0025 | 5 | |
| DG-0026 | 6 | |

| Driver Pins | | |
|-------------|------|---------------------|
| Part No. | Size | Price |
| DG-0051 | 1 | |
| DG-0052 | 2 | \$8.00 |
| DG-0053 | 3 | (100 pins per pack) |
| DG-0054 | 4 | |
| DG-0055 | 5 | |
| DG-0246 | 6 | |
| DG-0041 | 9 | |
| DG-0042 | 8 | \$36.00 |
| DG-0043 | 7 | (100 pins per pack) |
| DG-0044 | 6 | |
| DG-0045 | 5 | |
| DG-0246 | 6 | |
| DG-0247 | 7 | |
| DG-0248 | 8 | \$17.00 |
| DG-0249 | 9 | (100 pins per pack) |
| DG-0250 | 10 | |
| DG-0251 | 11 | |
| DG-0252 | 12 | |

| Driver Pins for Bump Resistance | | |
|---------------------------------|------|---------------------|
| Part No. | Size | Price |
| DG-0037 | 10 | |
| DG-0031 | 9 | |
| DG-0032 | 8 | \$16.00 |
| DG-0033 | 7 | (100 pins per pack) |
| DG-0034 | 6 | |
| DG-0035 | 5 | |
| DG-0036 | 4 | |

| DG2 & DG3 Bottom Pins – First 5 Positions | | |
|---|------|---------------------|
| Part No. | Size | Price |
| DG-0111 | 1L | |
| DG-0112 | 2L | |
| DG-0113 | 3L | |
| DG-0114 | 4L | |
| DG-0115 | 5L | |
| DG-0116 | 6L | |
| DG-0121 | 1C | |
| DG-0122 | 2C | \$39.00 |
| DG-0123 | 3C | (100 pins per pack) |
| DG-0124 | 4C | |
| DG-0125 | 5C | |
| DG-0126 | 6C | |
| DG-0131 | 1R | |
| DG-0132 | 2R | |
| DG-0133 | 3R | |
| DG-0134 | 4R | |
| DG-0135 | 5R | |
| DG-0136 | 6R | |

| Miscellaneous Parts | | |
|---------------------|---------------------------|---------------------------|
| Part No. | Description | Price (100 pins per pack) |
| DG-0016 | Screw | \$18.00 |
| DG-0017 | Compression Spring | \$35.00 |
| DG-0059 | Sidebar Spring | \$8.00 |
| DG-0060 | Slider Spring | \$10.00 |
| DG-0097 | Compression Spring - LFIC | \$35.00 |

| Cams for Degree Mortise Cylinders in Sargent Keyways | | |
|--|---|---------|
| Part No. | Description | Price |
| DG-0001 | Standard cam | |
| DG-0002 | Short cam (-105) used with Sargent mortise functions 16 & 92 on the inside cylinder | |
| DG-0004 | Adams Rite cam (-101) 1850, 4700 | |
| DG-0005 | Adams Rite short cam (-104) 4070, 4350, 4250, 4516, 4150 | \$11.92 |
| DG-0006 | 4370 Keyswitch cam (-113) | |
| DG-0007 | Schlage "L" cam (-106) | |
| DG-0008 | "Open" miscellaneous cam (-112) | |
| DG-2808 | Hotel cam (-115) used in 78/8250 functions | |

TABLE OF CONTENTS

USA & Canada Prices Effective June 3, 2019

| | | | |
|--|----------------------|--|-----------------------|
| Bored Locks - How to Order | BL-1 | 6500-Line Grade 2 Lever Cylindrical Lock..... | BL-36 |
| T-Zone (11 Line)..... | BL-2 - BL-21 | DL Series | BL-37 to BL-45 |
| T-Zone Options | BL-2 | DL Series – A, B, E, F, J, L, P, W Levers..... | BL-37 |
| T-Zone B, L, P Levers..... | BL-3 | DL Series – Coastal Series..... | BL-38 |
| T-Zone Options | BL-4 | DL Series – Studio Collection Levers (Except Gramercy Series)..... | BL-39 |
| T-Zone J Levers..... | BL-5 | DL Series – Studio Collection Levers (Wooster Square)..... | BL-40 |
| T-Zone Lockbody Assemblies..... | BL-6 to BL-9 | DL Series – Studio Collection Levers (Wooster Square & Grant Park)..... | BL-41 |
| T-Zone Levers & Roses | BL-10 | DL Series – Studio Collection Levers - Gramercy Series..... | BL-42 |
| T-Zone SL Levers | BL-11 | DL Series – Studio Collection Levers - Gramercy Series..... | BL-43 |
| T-Zone Locking Sleeve Assemblies..... | BL-12 to BL-13 | DL Series – SIMPLI™ Roseless Trim Coastal Series | BL-44 |
| T-Zone Locking Sleeve, Latch & Bearing Assemblies..... | BL-14 | DL Series – SIMPLI™ Roseless Trim Studio Collection Levers..... | BL-45 |
| T-Zone Parts | BL-15 | 8X Line Grade 1 Knob Lock | BL-46 - BL-47 |
| 10-Line Grade 1 Lever Lock | BL-16 - BL-27 | 8X Line Grade 1 Options | BL-46 |
| 10-Line Options..... | BL-16 | 8X Line Grade 1 Knob Lock & Strikes | BL-47 |
| 10-Line: B, L, P Levers | BL-17 | 6-Line Grade 2 Knob Lock..... | BL-48 - BL-51 |
| 10-Line Options..... | BL-18 | 6-Line Options..... | BL-48 |
| 10-Line: J Lever | BL-19 | 6-Line – Knob Design..... | BL-49 |
| 10-Line Coastal Series Options | BL-20 | 6-Line Latches/Parts | BL-50 |
| 10-Line Coastal Series Y, G Levers..... | BL-21 | 6-Line Parts..... | BL-51 |
| 10-Line Levers..... | BL-22 | | |
| 10-Line Coastal Series Levers..... | BL-23 | | |
| 10-Line Roses, Latches, Assemblies..... | BL-24 | | |
| 10-Line Lockbody Assemblies | BL-25 | | |
| 10-Line FW Lockbody Assemblies..... | BL-26 | | |
| 10-Line Parts..... | BL-27 | | |
| 7-Line Grade 2 Lever Lock | BL-28 - BL-35 | | |
| 7-Line Options..... | BL-28 | | |
| 7-Line: B, L, P Levers | BL-29 | | |
| 7-Line Coastal Series Options | BL-30 | | |
| 7-Line Coastal Series Y, G Levers..... | BL-31 | | |
| 7-Line Levers..... | BL-32 | | |
| 7-Line Coastal Series Levers | BL-33 | | |
| 7-Line Lockbody Assemblies | BL-34 | | |
| 7-Line Rose/Latches/Parts | BL-35 | | |

How to Order

| Step | Description | Example |
|----------------|--|--------------------------------------|
| Quantity | Each | 10 Ea. |
| Option | Consult catalog for options available | 10 Ea. 28- |
| Line | 11, 10, 9, 8X, 7, 6, DL, RDL & 6500 | 10 Ea. 28- 11 |
| Function | Consult catalog for functions available | 10 Ea. 28- 11 G05 |
| Design | Consult catalog for designs available | 10 Ea. 28- 11G05 LL |
| Finish | Consult catalog for finishes available | 10 Ea. 28- 11G05 LL US26D |
| Hand | Consult catalog for handing requirements | 10 Ea. 28- 11G05 LL US26D RH |
| Split Finishes | Specify outside finish first | 10 Ea. 28- 11G05 LL US26D/10B |

ANSI Finish and Function Comparison

| Function | | Finish | | |
|----------|------|---------|------|---|
| SARGENT | ANSI | SARGENT | ANSI | Description |
| U15 | F75 | US3 | 605 | Polished Brass |
| U65 | F76 | US4 | 606 | Satin Brass |
| G75 | F78 | US9 | 611 | Polished Bronze |
| G75-2 | F79 | US10 | 612 | Satin Bronze |
| G30 | F80 | US10B | 613 | Oxidized Satin Bronze / Oil Rubbed |
| G05 | F81 | US10BE | 613E | Dark Oxidized Satin Bronze - Equivalent |
| G24 | F82 | US10BL | 616 | Oxidized Satin Bronze / Lacquered |
| G37 | F84 | US14 | 618 | Polished Nickel, clear coated |
| G87 | F85 | US15 | 619 | Satin Nickel Plate |
| G04 | F86 | US20D | 622 | Dark Statuary Bronze / Powder coated |
| G17 | F87 | US26 | 625 | Polished Chrome |
| G16 | F88 | US26D | 626 | Satin Chrome |
| G13 | F89 | US32 | 629 | Polished Stainless Steel |
| G54 | F90 | US32D | 630 | Satin Stainless Steel |
| G26 | F91 | BSP | n/a | Black Suede Powder Coat |
| G44 | F92 | WSP | n/a | White Suede Powder Coat |
| G50 | F93 | NL | | No Lacquer |

Notes:

For locks with non-ferrous material for marine use, please contact the factory.

BL-2 BORED LOCKS

SARGENT®

OPTIONS

ASSA ABLOY

USA & Canada Prices Effective June 3, 2019

| Options | Description | Price |
|---------|---|------------------------|
| 10▲ | SARGENT Signature Key System | \$58.00 / cyl. |
| 11▲ | SARGENT XC Key System (not available with 10, 22, SC, SE options) | No addition |
| 1160▲ | Sargent XC Large Format Interchangeable Plastic Disposable Construction Core | No addition |
| 1163▲ | Sargent XC Large Format Interchangeable Core Cylinder - Includes masterkeying charges | \$77.00 |
| 1164▲ | Sargent XC Large Format Interchangeable Construction Core Cylinder | \$77.00 |
| 1170 | Small Format interchangeable disposable construction core - to accept 7 Pin XC permanent core | No addition |
| 11727P | Small Format interchangeable keyed construction core - to accept 7 Pin XC permanent core | \$69.00 |
| 11737P | Small Format interchangeable core - to accept 7 pin XC permanent core | \$69.00 /cyl. |
| 21▲ | SARGENT Construction Key System (lost ball) Standard on all new systems est. since 5/1/96 | \$16.00 / cyl. |
| 22 | SARGENT Construction Key System (split key) To be used on pre-est. split key system only | \$32.00 / cyl. |
| 23 | Lockset x 3-3/4" Backset | \$10.00 |
| 25 | Lockset x 5" Backset | \$17.00 |
| 28 | Lockset x ANSI A-156.115 Strike – 1-1/4" Lip Standard Lip Lengths 1-1/8" or 1-3/8" Lip Lengths 1-5/8", 1-7/8", 2-1/8", 2-3/8", 2-5/8", 2-7/8" | No addition \$11.00 |
| 30▲ | Lever to accept Schlage cylinder - no cylinder provided | No addition |
| 31▲ | For 2-1/4" to 2-1/2" thick doors, centered in door prep, no paneling. Consult factory for other door thicknesses available by special application. | \$260.00 |
| 36 | 6 Lobe security head screws | \$14.00 |
| 37 | Spanner head screws | \$9.00 |
| 41▲ | Lockset x 3/4" Throw (04, 05, 13, 15-3, 16, 17, 30, 37, 38 Functions) | \$98.00 |
| 60▲ | SARGENT Large Format Interchangeable Plastic Disposable Construction Core | No addition |
| 63▲ | SARGENT Large Format Interchangeable Core Cylinder includes master and grandmaster keying charge | \$77.00 / cyl. |
| 64▲ | SARGENT Large Format Interchangeable Construction Core Cylinder | \$77.00 |
| 6573▲ | Small Format 6 Pin Uncombined Core | \$59.00 / cyl. |
| 65737P▲ | Small Format 7 Pin Uncombined Core | \$59.00 / cyl. |
| 70▲ | Small Format Interchangeable disposable plastic construction core | No addition |
| 72▲ | Small Format Interchangeable 6-pin Construction Core (7-Pin w/11- option) | \$69.00 |
| 73▲ | Small Format Interchangeable Core, 6-Pin Includes MK and GMK keying charges | \$69.00 / cyl. |
| 737P▲ | Small Format Interchangeable Core, 7-Pin Includes MK and GMK keying charges | \$69.00 / cyl. |
| 74 | Lead Lining I/S Rose, O/S Rose, and Latch Tube | \$198.00 /lock |
| 75 | Tactile Warning - Milled on backside of inside lever | \$37.00 |
| 76 | Tactile Warning - Milled on backside of outside lever | \$37.00 |
| 77 | Tactile Warning - Milled on backside of both levers | \$74.00 |
| 80▲ | Levers to accept KESO and Keso F1 cylinders – no cylinders provided | -\$87.00/cyl. |
| 82▲ | SARGENT KESO Security Cylinder (existing Key Systems only) | \$84.00 /cyl. |
| F182▲ | SARGENT KESO Security Cylinder – patented –New Key Systems | \$84.00 /cyl. |
| 85 | Tactile Warning - Abrasive coating on inside lever | \$45.00 |
| 86 | Tactile Warning - Abrasive coating on outside lever | \$45.00 |
| 87 | Tactile Warning - Abrasive coating on both levers | \$90.00 |
| BR | SARGENT Bump Resistant Cyls. (N/A w/10, 22, 30, 60, 63, 64, 70, 72, 73, 737P, KESO, SC, SE) | \$23.00 /cyl. |
| DG1 | Patented Degree DG1 Key System | No Addition |
| DG160 | Hardware prepared for DG1-6300 Lg. Format IC cores, supplied with temporary plastic construction cores | No addition |
| DG163 | Patented Degree DG1 Large Format Interchangeable Core Cylinder - Includes master keying charges | \$77.00 |
| DG164 | Hardware prepared for DG1-6300 Lg. Format IC cores, supplied with temporary keyed construction cores | \$77.00 |
| DG2 | Patented Degree DG2 Key System incorporating a locking sidebar | \$58.00/cyl. |
| DG260 | Hardware prepared for DG2-6300 Lg. Format IC cores, supplied with temporary plastic construction cores | No addition |
| DG263 | Patented Degree DG2 Large Format Interchangeable Core Cylinder - Includes master keying charges | \$135.00 |
| DG264 | Hardware prepared for DG2-6300 Lg. Format IC cores, supplied with temporary keyed construction cores | \$77.00 |
| DG3 | Patented Degree DG3 Key System incorporating a locking sidebar and UL437 listed | \$82.00/cyl. |
| DG360 | Hardware prepared for DG3-6300 Lg. Format IC cores, supplied with temporary plastic construction cores | No addition |
| DG363 | Patented Degree DG3 Large Format Interchangeable Core Cylinder - Includes master keying charges | \$159.00 |
| DG364 | Hardware prepared for DG3-6300 Lg. Format IC cores, supplied with temporary keyed construction cores | \$77.00 |
| LC | Less Cylinder | -\$87.00/cyl. |
| SC▲ | Schlage C keyway cylinder "0" bitted | No addition |
| SE▲ | Schlage E keyway cylinder "0" bitted | No addition |
| SF | L Lever to accept Schlage Large Format Interchangeable Core (supplied less core, tailpiece included) | No Addition |
| SG | MicroShield® – an antimicrobial powder coat | \$67.00 |
| SL | High Security Lever attachment (not available on non-keyed functions) | No addition |
| STC | STC 55 Acoustical Door System | No addition |
| VC | Lock provided to accept ASSA V-10 Interchangeable Core Cylinders. V-10 cylinders are available from ASSA, Inc @ 800-235-7482 | No addition |
| WBS | Wrought Box Strike | No Addition |
| YC | L or P Lever to accept Yale® 6-pin fixed core cylinder | No addition |
| YC7P | L or P Lever to accept Yale® 7-pin fixed core cylinder | No addition |
| YRC | L or P Lever to accept Yale® 6-pin LFIC | No addition |
| YRC7P | L or P Lever to accept Yale® 7-pin LFIC | No addition |
| ▲ | Options not available in 50 function. | |
| CPC | Clear Powder Coat over 26D – 11G05 x OL x 26D x CPC All orders will continue to be handled as a "special" when CPC is ordered. | \$62.00 |

ASSA ABLOY, the global leader
in door opening solutions

Copyright © 2002-2019 Sargent Manufacturing Company, an ASSA ABLOY Group company. All rights reserved.
Reproduction in whole or in part without the express written permission of Sargent Manufacturing Company is prohibited.
Contact us at: 800-727-5477 or visit www.sargentlock.com. In Canada contact us at: 800-461-3007 or visit www.assaabloydss.ca

Rose Design:

- O Rose - 2-3/4" Dia. – Shown
- B Rose - 2-3/4" Dia. – Shown
- L Rose - 3-1/2" Dia.
- E Rose - 3-1/8" Sq. – Shown

Lever Design:

- B – Shown
- L – Shown
- P – Shown



OL



EB



BP

| Function | | Finish | |
|------------------------|------------------------------------|------------------|-----------------------------------|
| | | 10BE/26D/BSP/WSP | 03/04/09/10/10B/10BL/14/15/20D/26 |
| Single Cylinder | | | |
| 11G04 | Storeroom/Closet | | |
| 11G05 | Entry/Office | \$664.00 | \$680.00 |
| 11G37 | Classroom | | |
| 11G24 | Entry | \$678.00 | \$694.00 |
| 11G44 | Service Station | | |
| 11G50 | Hotel | \$745.00 | \$761.00 |
| 11G54 | Dormitory | | |
| Double Cylinder | | | |
| 11G16 | Classroom Security/Public Entrance | | |
| 11G17 | Utility/Asylum/Institutional | \$779.00 | \$795.00 |
| 11G30 | Communicating | | |
| * 11G38 | Classroom Security | | |
| Non Keyed | | | |
| 11U15 | Passage | \$494.00 | \$510.00 |
| 11G13 | Exit | | |
| 11G15-3 | Exit | | |
| 11U65 | Privacy | \$563.00 | \$579.00 |
| 11U68 | Hospital/Privacy | | |
| 11U93 | Dummy Trim | \$222.00 | \$230.00 |
| 11U94 | Dummy Trim | \$436.00 | \$452.00 |
| 11U94-2 | Dummy Trim | \$441.00 | \$457.00 |

Note: Split finishes are available, price as higher finish. Order outside/inside and handing must be specified. Strike and latch front will match inside finish for RH/LH and outside finish for RHR/LHR.

| Strokes – See catalog for available lip lengths | | Specify Finish |
|---|---|---------------------|
| 800 | ANSI A115.2 T Strike (Standard) Lip Lengths available: 1", 1-1/4" (Standard), 1-1/2", 1-3/4", 2" | Refer to page BL-47 |
| 808 | ANSI A115.2 – 4-7/8" Strike (Option 28-) Lip Lengths available: 1-1/8", 1-1/4" (Standard), 1-3/8", 1-5/8", 1-7/8", 2-1/8", 2-3/8", 2-5/8", 2-7/8" | Refer to page BL-47 |
| AM-0044 | Strike Box (Standard) | \$10.80 |
| 77-1141 | Strike Box (Option 28-) | \$10.80 |

*Not available on B rose design

BL-4 BORED LOCKS

SARGENT®

Tone™ J OPTIONS

ASSA ABLOY

USA & Canada Prices Effective June 3, 2019

| Options | Description | Price |
|-----------|---|------------------------|
| 10▲ | SARGENT Signature Key System | \$58.00 / cyl. |
| 11▲ | SARGENT XC Key System (not available with 10, 22, SC, SE options) | No addition |
| 1160▲ | Sargent XC Large Format Interchangeable Plastic Disposable Construction Core | No addition |
| 1163▲ | Sargent XC Large Format Interchangeable Core Cylinder - Includes masterkeying charges | \$77.00 |
| 1164▲ | Sargent XC Large Format Interchangeable Construction Core Cylinder | \$77.00 |
| 21▲ | SARGENT Construction Key System (lost ball) Standard on all new systems est. since 5/1/96 | \$16.00 / cyl. |
| 22 | SARGENT Construction Key System (split key) To be used on pre-est. split key system only | \$32.00 / cyl. |
| 23 | Lockset x 3-3/4" Backset | \$10.00 |
| 25 | Lockset x 5" Backset | \$17.00 |
| 28 | Lockset x ANSI A-156.115 Strike – 1-1/4" Lip Standard Lip Lengths 1-1/8" or 1-3/8" Lip Lengths 1-5/8", 1-7/8", 2-1/8", 2-3/8", 2-5/8", 2-7/8" | No addition \$11.00 |
| 30▲ | Lever to accept Schlage cylinder - no cylinder provided | No addition |
| 31▲ | For 2-1/4" to 2-1/2" thick doors, centered in door prep, no paneling. Consult factory for other door thicknesses available by special application. | \$260.00 |
| 36 | 6 Lobe security head screws | \$14.00 |
| 37 | Spanner head screws | \$9.00 |
| 41▲ | Lockset x 3/4" Throw (04, 05, 13, 15-3, 16, 17, 30, 37, 38 Functions) | \$98.00 |
| 60▲ | SARGENT Large Format Interchangeable Plastic Disposable Construction Core | No addition |
| 63▲ | SARGENT Large Format Interchangeable Core Cylinder includes master and grandmaster keying charge | \$77.00 / cyl. |
| 64▲ | SARGENT Large Format Interchangeable Construction Core Cylinder | \$77.00 |
| 6573▲ | Small Format 6 Pin Uncombined Core | \$59.00 / cyl. |
| 65737P▲ | Small Format 7 Pin Uncombined Core | \$59.00 / cyl. |
| 70▲ | Small Format Interchangeable disposable plastic construction core | No addition |
| 72▲ | Small Format Interchangeable 6-pin Construction Core (7-Pin w/11- option) | \$69.00 |
| 73▲ | Small Format Interchangeable Core, 6-Pin Includes MK and GMK keying charges | \$69.00 / cyl. |
| 737P▲ | Small Format Interchangeable Core, 7-Pin (refer to CK-12 for available keyways) Includes MK and GMK keying charges | \$69.00 / cyl. |
| 74 | Lead Lining I/S Rose, O/S Rose, and Latch Tube | \$198.00 /lock |
| 75 | Tactile Warning - Milled on backside of inside lever | \$37.00 |
| 76 | Tactile Warning - Milled on backside of outside lever | \$37.00 |
| 77 | Tactile Warning - Milled on backside of both levers | \$74.00 |
| 80▲ | Levers to accept KESO and Keso F1 cylinders – no cylinders provided | -\$87.00/cyl. |
| F182▲ | SARGENT KESO Security Cylinder – patented –New Key Systems | \$84.00 /cyl. |
| 82▲ | SARGENT KESO Security Cylinder (existing Key Systems only) | \$84.00 /cyl. |
| 85 | Tactile Warning - Abrasive coating on inside lever | \$45.00 |
| 86 | Tactile Warning - Abrasive coating on outside lever | \$45.00 |
| 87 | Tactile Warning - Abrasive coating on both levers | \$90.00 |
| BR | SARGENT Bump Resistant Cyls. (N/A w/10, 22, 30, 60, 63, 64, 70, 72, 73, 737P, KESO, SC, SE) | \$23.00 /cyl. |
| DG1 | Patented Degree DG1 Key System | No Addition |
| DG160 | Hardware prepared for DG1-6300 Lg. Format IC cores, supplied with temporary plastic construction cores | No addition |
| DG163 | Patented Degree DG1 Large Format Interchangeable Core Cylinder - Includes master keying charges | \$77.00 |
| DG164 | Hardware prepared for DG1-6300 Lg. Format IC cores, supplied with temporary keyed construction cores | \$77.00 |
| DG2 | Patented Degree DG2 Key System incorporating a locking sidebar | \$58.00/cyl. |
| DG260 | Hardware prepared for DG2-6300 Lg. Format IC cores, supplied with temporary plastic construction cores | No addition |
| DG263 | Patented Degree DG2 Large Format Interchangeable Core Cylinder - Includes master keying charges | \$135.00 |
| DG264 | Hardware prepared for DG2-6300 Lg. Format IC cores, supplied with temporary keyed construction cores | \$77.00 |
| DG3 | Patented Degree DG3 Key System incorporating a locking sidebar and UL437 listed | \$82.00/cyl. |
| DG360 | Hardware prepared for DG3-6300 Lg. Format IC cores, supplied with temporary plastic construction cores | No addition |
| DG363 | Patented Degree DG3 Large Format Interchangeable Core Cylinder - Includes master keying charges | \$159.00 |
| DG364 | Hardware prepared for DG3-6300 Lg. Format IC cores, supplied with temporary keyed construction cores | \$77.00 |
| LC | Less Cylinder | -\$87.00/cyl. |
| SC▲ | Schlage C keyway cylinder "0" bitted | No addition |
| SE▲ | Schlage E keyway cylinder "0" bitted | No addition |
| SG | MicroShield® – an antimicrobial powder coat | \$67.00 |
| SL | High Security Lever attachment (not available on non-keyed functions) | No addition |
| STC | STC 55 Acoustical Door System | No addition |
| VC | Lock provided to accept ASSA V-10 Interchangeable Core Cylinders. V-10 cylinders are available from ASSA, Inc @ 800-235-7482 | No addition |
| WBS | Wrought Box Strike | No Addition |
| ▲ Options | not available in 50 function. | |
| CPC | Clear Powder Coat over 26D – 11G05 x OL x 26D x CPC All orders will continue to be handled as a "special" when CPC is ordered. | \$62.00 |

Rose Design:

- O Rose - 2-3/4" Dia.
- B Rose - 2-3/4" Dia.
- L Rose - 3-1/2" Dia. – Shown
- E Rose - 3-1/8" Sq.

Lever Design:

J – Shown



LJ

| Function | | Finish | |
|------------------------|------------------------------------|------------------|-----------------------------------|
| | | 10BE/26D/BSP/WSP | 03/04/09/10/10B/10BL/14/15/20D/26 |
| Single Cylinder | | | |
| 11G04 | Storeroom/Closet | | |
| 11G05 | Entry/Office | \$682.00 | \$698.00 |
| 11G37 | Classroom | | |
| 11G24 | Entry | \$700.00 | \$716.00 |
| 11G44 | Service Station | | |
| 11G50 | Hotel | \$764.00 | \$780.00 |
| 11G54 | Dormitory | | |
| Double Cylinder | | | |
| 11G16 | Classroom Security/Public Entrance | | |
| 11G17 | Utility/Asylum/Institutional | \$798.00 | \$814.00 |
| 11G30 | Communicating | | |
| 11G38 | Classroom Security | | |
| Non Keyed | | | |
| 11U15 | Passage | \$516.00 | \$532.00 |
| 11G13 | Exit | | |
| 11G15-3 | Exit | \$587.00 | \$603.00 |
| 11U65 | Privacy | | |
| 11U68 | Hospital/Privacy | | |
| 11U93 | Dummy Trim | \$231.00 | \$239.00 |
| 11U94 | Dummy Trim | \$456.00 | \$472.00 |
| 11U94-2 | Dummy Trim | \$461.00 | \$477.00 |

Note: Split finishes are available, price as higher finish. Order outside/inside and handing must be specified. Strike and latch front will match inside finish for RH/LH and outside finish for RHR/LHR.

| Strokes – See catalog for available lip lengths | | Specify Finish |
|---|---|---------------------|
| 800 | ANSI A115.2 T Strike (Standard) Lip Lengths available: 1", 1-1/4" (Standard), 1-1/2", 1-3/4", 2" | Refer to page BL-47 |
| 808 | ANSI A115.2 – 4-7/8" Strike (Option 28-) Lip Lengths available: 1-1/8", 1-1/4" (Standard), 1-3/8", 1-5/8", 1-7/8", 2-1/8", 2-3/8", 2-5/8", 2-7/8" | Refer to page BL-47 |
| AM-0044 | Strike Box (Standard) | \$10.80 |
| 77-1141 | Strike Box (Option 28-) | \$10.80 |

BL-6 BORED LOCKS

SARGENT®

Tone™ LOCK BODY ASSEMBLIES

ASSA ABLOY

USA & Canada Prices Effective June 3, 2019

| Lock Body Assemblies - For non-cylinder and standard cylinder and 10-, 21-, 22-, 30- SC-, SE- | | |
|--|----------|----------|
| Part No | Function | Price |
| 11-2294 | 04 | |
| * 11-2295 | 05 | \$311.51 |
| 11-2304 | 37 | |
| * 11-2301 | 24 | |
| * 11-2305 | 44 | \$337.22 |
| * 11-2307 | 54 | |
| * 11-2306 | 50 | \$343.62 |
| 11-2299 | 16 | |
| 11-2300 | 17 | \$362.90 |
| 11-2303 | 30 | |
| 11-2311 | 38 | |
| 11-2297 | 15 | \$231.21 |
| 11-2296 | 13 | |
| 11-2298 | 15-3 | \$272.99 |
| * 11-2308 | 65, 68 | |
| Lock Body Assemblies - 41- Option For non-cylinder and standard cylinder and 10-, 21-, 22-, 30- SC-, SE- | | |
| Part No | Function | Price |
| 11-2337 | 04 | |
| * 11-2338 | 05 | \$356.46 |
| 11-2342 | 37 | |
| 11-2341 | 16 | \$407.85 |
| 11-2340 | 15-3 | \$317.91 |
| 11-2339 | 15 | \$276.16 |
| Lock Body Assemblies - For Removable (60-) and Interchangeable Core (70-) Cylinder Functions | | |
| Part No | Function | Price |
| 11-2349 | 04 | |
| * 11-2350 | 05 | \$321.16 |
| 11-2355 | 37 | |
| * 11-2353 | 24 | |
| * 11-2356 | 44 | \$346.81 |
| * 11-2358 | 54 | |
| 11-2351 | 16 | |
| 11-2352 | 17 | \$372.52 |
| 11-2354 | 30 | |
| 11-2361 | 38 | |
| Lock Body Assemblies - 41- Option - For Removable (60-) and Interchangeable Core (70-) Cylinder Functions | | |
| Part No | Function | Price |
| 11-2380 | 04 | |
| * 11-2381 | 05 | \$366.10 |
| 11-2383 | 37 | |
| * 11-2382 | 16 | \$417.49 |

Note: Lockbodies are shipped with bearing assembly, inside & outside sleeve, and inside & outside collar.

* Specify finish when ordering.

Lock Body Assemblies - For 82- KESO cylinder functions

| Part No | Function | Price |
|-----------|----------|----------|
| 11-2426 | 04 | |
| * 11-2427 | 05 | \$327.56 |
| 11-2432 | 37 | |
| * 11-2430 | 24 | |
| * 11-2434 | 44 | \$353.26 |
| * 11-2435 | 54 | |
| 11-2428 | 16 | |
| 11-2429 | 17 | |
| 11-2431 | 30 | \$378.94 |
| 11-2433 | 38 | |

Lock Body Assemblies - For 41- Option - For 82- KESO cylinder functions

| Part No | Function | Price |
|-----------|----------|----------|
| 11-2585 | 04 | |
| * 11-2586 | 05 | \$372.52 |
| 11-2588 | 37 | |
| * 11-2587 | 16 | \$423.91 |

Note: Lockbodies are shipped with bearing assembly, inside & outside sleeve, and inside & outside collar.

* Specify finish when ordering

BL-8 BORED LOCKS

SARGENT®

TZone™ SL LOCK BODY ASSEMBLIES

ASSA ABLOY

USA & Canada Prices Effective June 3, 2019

| SL-Lock Body Assemblies - For non-cylinder and standard cylinder and 10-, 21-, 22-, 30- SC-, SE- | | |
|--|----------|----------|
| Part No | Function | Price |
| 11-2672 | 04 | |
| * 11-2673 | 05 | \$311.51 |
| 11-2678 | 37 | |
| * 11-2676 | 24 | |
| * 11-2680 | 44 | \$337.22 |
| * 11-2682 | 54 | |
| * 11-2681 | 50 | \$343.62 |
| 11-2674 | 16 | |
| 11-2675 | 17 | |
| 11-2677 | 30 | \$362.90 |
| 11-2679 | 38 | |
| SL-Lock Body Assemblies - 41- Option For non-cylinder and standard cylinder and 10-, 21-, 22-, 30- SC-, SE- | | |
| Part No | Function | Price |
| 11-2696 | 04 | |
| * 11-2697 | 05 | \$356.46 |
| 11-2699 | 37 | |
| 11-2698 | 16 | \$407.85 |
| SL-Lock Body Assemblies - For removable (60-) core cylinder functions | | |
| Part No | Function | Price |
| 11-2700 | 04 | |
| * 11-2701 | 05 | \$321.16 |
| 11-2706 | 37 | |
| * 11-2704 | 24 | |
| * 11-2708 | 44 | \$346.83 |
| * 11-2709 | 54 | |
| 11-2702 | 16 | |
| 11-2703 | 17 | |
| 11-2705 | 30 | \$372.52 |
| 11-2707 | 38 | |
| SL-Lock Body Assemblies - 41- Option - For removable (60-) core cylinder functions | | |
| Part No | Function | Price |
| 11-2722 | 04 | |
| * 11-2723 | 05 | \$366.10 |
| 11-2725 | 37 | |
| * 11-2724 | 16 | \$417.49 |
| SL-Lock Body Assemblies - For interchangeable (70-) core cylinder functions | | |
| Part No | Function | Price |
| 11-2775 | 04 | |
| * 11-2776 | 05 | \$321.16 |
| 11-2781 | 37 | |
| * 11-2779 | 24 | |
| * 11-2783 | 44 | \$346.81 |
| * 11-2784 | 54 | |
| 11-2777 | 16 | |
| 11-2778 | 17 | |
| 11-2780 | 30 | \$372.52 |
| 11-2782 | 38 | |
| SL-Lock Body Assemblies - 41- Option - For interchangeable (70-) core cylinder functions | | |
| Part No | Function | Price |
| 11-2813 | 04 | |
| * 11-2814 | 05 | \$366.10 |
| 11-2816 | 37 | |
| * 11-2815 | 16 | \$417.49 |

Note: Lockbodies are shipped with bearing assembly, inside & outside sleeve, and inside & outside collar.

* Specify finish when ordering.

SL-Lock Body Assemblies - For 82- KESO cylinder functions

| Part No | Function | Price |
|-----------|----------|----------|
| 11-2843 | 04 | |
| * 11-2844 | 05 | \$327.56 |
| 11-2849 | 37 | |
| * 11-2847 | 24 | |
| * 11-2851 | 44 | \$353.26 |
| * 11-2852 | 54 | |
| 11-2845 | 16 | |
| 11-2846 | 17 | |
| 11-2848 | 30 | \$378.94 |
| 11-2850 | 38 | |

SL-Lock Body Assemblies - For 41- Option - For 82- KESO cylinder functions

| Part No | Function | Price |
|-----------|----------|----------|
| 11-2865 | 04 | |
| * 11-2866 | 05 | \$372.52 |
| 11-2868 | 37 | |
| * 11-2867 | 16 | \$423.91 |

Note: Lockbodies are shipped with bearing assembly, inside & outside sleeve, and inside & outside collar.

* Specify finish when ordering

BL-10 BORED LOCKS

SARGENT®

LEVERS & ROSES

ASSA ABLOY

USA & Canada Prices Effective June 3, 2019

| Levers | | Finish | |
|----------|--|--|---------|
| Part No. | Description (Inside or Outside) | 03/04/09/10/10B/10BE/10BL/ 14/15/20D/26/26D/BSP/WSP | |
| 11-0041 | L lever, plain | | |
| 11-0043 | L lever, std. cylinder, button and emergency release | | |
| 11-0044 | L lever, 60- option SARGENT removable core | | |
| 11-0045 | L lever, 70- option interchangeable core | | |
| 11-0046 | L lever, 30- option to accept Schlage cyl | | |
| 11-0047 | L lever, VC- option | | |
| 11-0048 | L lever, 82- option to accept KESO | | |
| 11-0399 | L lever, SF- option Schlage LFIC | | |
| 11-0441 | L lever, YC- or YC-7P- option to accept Yale® 6- or 7-pin fixed core cylinder | | |
| 11-0443 | L lever, YRC- option to accept Yale® 6-pin LFIC | | |
| 11-0445 | L lever, YRC-7P- option to accept Yale® 7-pin LFIC | | |
| 11-0061 | B lever, plain | | |
| 11-0063 | B lever, std. cylinder, button and emergency release | | \$81.00 |
| 11-0064 | B lever, 60- option SARGENT removable core | | |
| 11-0065 | B lever, 70- option interchangeable core | | |
| 11-0066 | B lever, 30- option to accept Schlage cyl | | |
| 11-0067 | B lever, VC- option | | |
| 11-0068 | B lever, 82- option to accept KESO | | |
| 11-0101 | P lever, plain | | |
| 11-0103 | P lever, std. cylinder, button and emergency release | | |
| 11-0104 | P lever, 60- option SARGENT removable core | | |
| 11-0105 | P lever, 70- option interchangeable core | | |
| 11-0106 | P lever, 30- option to accept Schlage cyl | | |
| 11-0107 | P lever, VC- option | | |
| 11-0108 | P lever, 82- option to accept KESO | | |
| 11-0447 | P lever, YC- or YC-7P- option to accept Yale® 6- or 7-pin fixed core cylinder | | |
| 11-0449 | P lever, YRC- option to accept Yale® 6-pin LFIC | | |
| 11-0451 | P lever, YRC-7P- option to accept Yale® 7-pin LFIC | | |
| 11-2558 | J lever, plain | | |
| 11-2560 | J lever, std. cylinder, button and emergency release | | |
| 11-2561 | J lever, 60- option SARGENT removable core | | |
| 11-2562 | J lever, 70- option interchangeable core | | \$87.00 |
| 11-2563 | J lever, 30- option to accept Schlage cyl | | |
| 11-2564 | J lever, VC- option | | |
| 11-2565 | J lever, 82- option to accept KESO | | |
| Note: | For handicapped levers, consult factory Standard Cylinder includes 10, 21, 22, SC, SE options | | |

| Roses | | Finish | |
|----------|--|---------------------|---------------------------------------|
| Part No. | Description | 10BE/26D BSP/WSP | 03/04/09/10/10B/ 10BL/14/15/20D/26 |
| 11-2444 | O rose assy, inside or outside - all except O/S 15-3, 93, 94 and I/S 38 functions | | |
| 11-2482 | O rose assy, outside - 15-3 function | | |
| 11-2887 | O rose assy, inside - 38 function | | |
| 11-2448 | O rose assy, inside or outside - 93, 94 functions | \$40.12 | \$46.55 |
| 11-2445 | B rose assy, inside or outside - all except O/S 15-3, 93, 94 functions | | |
| 11-2483 | B rose assy, outside - 15-3 function | | |
| 11-2449 | B rose assy, inside or outside - 93, 94 functions | | |
| 11-2447 | E rose assy, inside or outside - all except O/S 15-3, 93, 94 and I/S 38 functions | | |
| 11-2484 | E rose assy, outside - 15-3 function | \$43.35 | \$49.74 |
| 11-2889 | E rose assy, inside - 38 function | | |
| 11-2451 | E rose assy, inside or outside - 93, 94 functions | | |
| 11-2446 | L rose assy, inside or outside - all except O/S 15-3, 93, 94 and I/S 38 functions | | |
| 11-2450 | L rose assy, inside or outside - 93, 94 functions | \$46.55 | \$53.00 |
| 11-2485 | L rose assy, outside - 15-3 function | | |
| 11-2888 | L rose assy, inside - 38 function | | |

USA & Canada Prices Effective June 3, 2019

| SL-Levers | | Finish |
|-----------|--|--|
| Part No. | Description (Inside or Outside) | 03/04/09/10/10B/10BE/ 10BL/14/15/20D/26/26D/BSP/WSP |
| 11-0301 | SL-L lever, std. cylinder and emergency release (65) | |
| 11-0302 | SL-L lever, 60- option SARGENT removable core | |
| 11-0303 | SL-L lever, 70- option interchangeable core | |
| 11-0304 | SL-L lever, 30- option to accept Schlage cyl | |
| 11-0305 | SL-L lever, VC- option | |
| 11-0306 | SL-L lever, 82- option to accept KESO | |
| 11-0401 | SL- L Lever, SF- option Schlage LFIC | |
| 11-0317 | SL-B lever, std. cylinder and emergency release (65) | |
| 11-0318 | SL-B lever, 60- option SARGENT removable core | |
| 11-0319 | SL-B lever, 70- option interchangeable core | |
| 11-0320 | SL-B lever, 30- option to accept Schlage cyl | \$81.00 |
| 11-0321 | SL-B lever, VC- option | |
| 11-0322 | SL-B lever, 82- option to accept KESO | |
| 11-0349 | SL-P lever, std. cylinder and emergency release (65) | |
| 11-0350 | SL-P lever, 60- option SARGENT removable core | |
| 11-0351 | SL-P lever, 70- option interchangeable core | |
| 11-0352 | SL-P lever, 30- option to accept Schlage cyl | |
| 11-0353 | SL-P lever, VC- option | |
| 11-0354 | SL-P lever, 82- option to accept KESO | |
| 11-2869 | SL-J lever, std. cylinder and emergency release (65) | |
| 11-2870 | SL-J lever, 60- option SARGENT removable core | |
| 11-2871 | SL-J lever, 70- option interchangeable core | \$87.00 |
| 11-2872 | SL-J lever, 30- option to accept Schlage cyl | |
| 11-2873 | SL-J lever, VC- option | |
| 11-2874 | SL-J lever, 82- option to accept KESO | |

Note: For handicapped levers, consult factory
Standard cylinder includes 10, 21, 22, SC, SE options

BL-12 BORED LOCKS

SLEEVE ASSEMBLIES

SARGENT®

ASSA ABLOY

USA & Canada Prices Effective June 3, 2019

| Locking Sleeve Assemblies for standard cylinder functions. 10-, 21-, 22-, 30-, SC, SE- | | Price |
|---|---|--------------|
| Part No | Description | |
| 11-2009 | Locking sleeve assy - 04, 05, 16, 44 function, outside | \$157.36 |
| 11-2010 | Locking sleeve assy - 13 function, outside | \$83.50 |
| 11-2011 | Locking sleeve assy - 16, 38 function, inside | \$208.75 |
| 11-2012 | Locking sleeve assy - 17 function, outside | \$154.14 |
| 11-2013 | Locking sleeve assy - 17 function, inside | \$150.92 |
| 11-2014 | Locking sleeve assy - 30, 37 function, outside | \$154.14 |
| 11-2015 | Locking sleeve assy - 30 function, inside | \$150.92 |
| 11-2016 | Locking sleeve assy - 50 function, outside | \$157.36 |
| 11-2017 | Locking sleeve assy - 38, 54 function, outside | \$176.61 |
| 11-2055 | Locking sleeve assy - 65 function, outside | \$134.88 |
| 11-2909 | Locking sleeve assy - 24 function, outside | \$157.36 |
| 11-2028 | Locking sleeve assy, 41- option, 3/4" throw latch -4, 05, 16 function, outside | \$163.79 |
| 11-2029 | Locking sleeve assy, 41- option, 3/4" throw latch -16 function, inside | \$208.75 |
| 11-2030 | Locking sleeve assy, 41- option, 3/4" throw latch -37 function, outside | \$154.14 |

Note: for 41- option locking sleeves used with other cylinder options, consult factory for part number.

| Locking Sleeve Assemblies for 63- (60-) option removable core & 73- (70-) option interchangeable core | | Price |
|--|--|--------------|
| Part No | Description | |
| 11-2031 | Locking sleeve assy - 04, 05, 16, 44 function, outside | \$160.57 |
| 11-2032 | Locking sleeve assy - 16, 38 function, inside | \$154.14 |
| 11-2033 | Locking sleeve assy - 17 function, outside | \$154.14 |
| 11-2034 | Locking sleeve assy - 17 function, inside | \$154.14 |
| 11-2035 | Locking sleeve assy - 30, 37 function, outside | \$154.14 |
| 11-2036 | Locking sleeve assy - 30 function, inside | \$147.71 |
| 11-2037 | Locking sleeve assy - 38, 54 function, outside | \$173.42 |
| 11-2911 | Locking sleeve assy - 24 function, outside | \$160.57 |

Note: for 63- or 73- option locking sleeve used with 31- or 41- options, consult factory for part number.

| Locking Sleeve Assemblies for 82- option KESO | | |
|--|--|----------|
| Part No | Description | Price |
| 11-2069 | Locking sleeve assy - 04, 05, 16, 44 function, outside | \$160.57 |
| 11-2070 | Locking sleeve assy - 16, 38 function, inside | \$154.14 |
| 11-2071 | Locking sleeve assy - 17, outside | \$154.14 |
| 11-2072 | Locking sleeve assy - 17, inside | \$154.14 |
| 11-2073 | Locking sleeve assy - 30, 37, outside | \$154.14 |
| 11-2074 | Locking sleeve assy - 30, inside | \$147.74 |
| 11-2075 | Locking sleeve assy - 38, 54, outside | \$173.42 |
| 11-2915 | Locking sleeve assy - 24 function, outside | \$160.57 |

| Locking Sleeve Assemblies for VC- option interchangeable core | | |
|--|--|----------|
| Part No | Description | Price |
| 11-2039 | Locking sleeve assy - 04, 05, 16, 44 function, outside | \$157.36 |
| 11-2040 | Locking sleeve assy - 16, 38 function, inside | \$115.61 |
| 11-2041 | Locking sleeve assy - 17 function, outside | \$154.14 |
| 11-2042 | Locking sleeve assy - 17 function, inside | \$154.14 |
| 11-2043 | Locking sleeve assy - 30, 37 function, outside | \$154.14 |
| 11-2044 | Locking sleeve assy - 30 function, inside | \$150.92 |
| 11-2045 | Locking sleeve assy - 38, 54 function, outside | \$163.79 |
| 11-2913 | Locking sleeve assy - 24 function, outside | \$157.36 |

| Non-Locking Sleeve Assemblies (for standard cylinder functions, 10-, 21-, 22-, 30-, SC, SE-) | | |
|---|--|----------|
| Part No | Description | Price |
| 11-2151 | Non-locking sleeve assy - 04, 13 function, inside | \$73.86 |
| * 11-2152 | Non-locking sleeve assy - 05 function, inside | \$112.41 |
| 11-2153 | Non-locking sleeve assy - 15, 15-3, 37 function, inside - 15 function, outside | \$73.86 |
| * 11-2154 | Non-locking sleeve assy - 44 function, inside | \$112.41 |
| * 11-2155 | Non-locking sleeve assy - 50 function, inside | \$122.05 |
| * 11-2156 | Non-locking sleeve assy - 54, 65 function, inside | \$112.41 |
| * 11-2157 | Non-locking sleeve assy - 24function, inside | \$157.36 |

| | | |
|-----------|--|----------|
| 11-2166 | Non-locking sleeve assy, 41- option 3/4" throw latch -04 function, inside | \$73.86 |
| * 11-2167 | Non-locking sleeve assy, 41- option 3/4" throw latch -05 function, inside | \$112.41 |
| 11-2168 | Non-locking sleeve assy, 41- option 3/4" throw latch -15, 15-3, 37 function, inside/15 function outside | \$77.07 |

*Specify finish when ordering

| SL-Locking Sleeve Assemblies for standard cylinder functions, 10-, 21-, 22-, 30-, SC, SE- | | |
|--|---|----------|
| Part No | Description | Price |
| 11-2597 | SL-Locking sleeve assy - 04, 05, 16, 24, 44 function, outside | \$157.36 |
| 11-2598 | SL-Locking sleeve assy - 16, 38 function, inside | \$208.75 |
| 11-2599 | SL-Locking sleeve assy - 17 function, outside | \$154.14 |
| 11-2600 | SL-Locking sleeve assy - 17 function, inside | \$150.92 |
| 11-2601 | SL-Locking sleeve assy - 30, 37 function, outside | \$154.14 |
| 11-2602 | SL-Locking sleeve assy - 30 function, inside | \$150.92 |
| 11-2603 | SL-Locking sleeve assy - 50 function, outside | \$157.36 |
| 11-2604 | SL-Locking sleeve assy - 38, 54 function, outside | \$176.61 |
| 11-2614 | SL-Locking sleeve assy, 41- option, 3/4" throw latch -04, 05, 16 function, outside | \$163.79 |
| 11-2615 | SL-Locking sleeve assy, 41- option, 3/4" throw latch -16 function, inside | \$208.75 |
| 11-2616 | SL-Locking sleeve assy, 41- option, 3/4" throw latch -37 function, outside | \$154.14 |

Note: for 41- option locking sleeves used with other cylinder options, consult factory for part number.

| SL-Locking Sleeve Assemblies for 63- or 73- option removable or interchangeable core | | |
|---|---|----------|
| Part No | Description | Price |
| 11-2617 | SL-Locking sleeve assy - 04, 05, 16, 24, 44 function, outside | \$160.57 |
| 11-2618 | SL-Locking sleeve assy - 16, 38 function, inside | \$154.14 |
| 11-2619 | SL-Locking sleeve assy - 17 function, outside | \$154.14 |
| 11-2620 | SL-Locking sleeve assy - 17 function, inside | \$154.14 |
| 11-2621 | SL-Locking sleeve assy - 30, 37 function, outside | \$154.14 |
| 11-2622 | SL-Locking sleeve assy - 30 function, inside | \$147.74 |
| 11-2623 | SL-Locking sleeve assy - 38, 54 function, outside | \$173.42 |

Note: for 63- or 73- option locking sleeve used with 31- or 41- options, consult factory for part number.

BL-14 BORED LOCKS

SARGENT®



SL-SLEEVE, LATCH, & BEARING ASSEMBLIES

ASSA ABLOY

USA & Canada Prices Effective June 3, 2019

| SL-Locking Sleeve Assemblies for 82- option KESO | | |
|---|---|--|
| Part No | Description | Price |
| 11-2653 | SL-Locking sleeve assy - 04, 05, 16, 24, 44 function, outside | \$160.57 |
| 11-2654 | SL-Locking sleeve assy - 16, 38 function, inside | \$154.14 |
| 11-2655 | SL-Locking sleeve assy - 17, outside | \$154.14 |
| 11-2656 | SL-Locking sleeve assy - 17, inside | \$154.14 |
| 11-2657 | SL-Locking sleeve assy - 30, 38, outside | \$154.14 |
| 11-2658 | SL-Locking sleeve assy - 30, inside | \$147.74 |
| 11-2659 | SL-Locking sleeve assy - 38, 54, outside | \$173.42 |
| SL-Locking Sleeve Assemblies for VC- option interchangeable core | | |
| Part No | Description | Price |
| 11-2635 | SL-Locking sleeve assy - 04, 05, 16, 24, 44 function, outside | \$157.36 |
| 11-2636 | SL-Locking sleeve assy - 16, 38 function, inside | \$115.61 |
| 11-2637 | SL-Locking sleeve assy - 17 function, outside | \$154.14 |
| 11-2638 | SL-Locking sleeve assy - 17 function, inside | \$154.14 |
| 11-2639 | SL-Locking sleeve assy - 30, 37 function, outside | \$154.14 |
| 11-2640 | SL-Locking sleeve assy - 30 function, inside | \$150.92 |
| 11-2641 | SL-Locking sleeve assy - 38, 54 function, outside | \$163.79 |
| Latch Assemblies (specify finish when ordering) | | |
| Part # | Description | Finish 03/04/09/10/10B/10BE/10BL/20D/32/32D/BSP/WSP Price |
| 11-2106 | 2-3/4" BS, Guarded latch assy 04, 05, 13, 15-3, 16, 17, 30, 37, 38 function | \$128.46 |
| 11-2108 | 2-3/4" BS, Guarded latch assy 24 function | \$128.46 |
| 11-2110 | 2-3/4" BS, Guarded latch assy 44, 50, 54 function | \$128.46 |
| 11-2107 | 2-3/4" BS, Unguarded latch assy 15 function | \$128.46 |
| 11-2111 | 2-3/4" BS, Unguarded latch assy 65, 68 function | \$128.46 |
| 11-2112 | 2-3/4" BS, Unguarded latch assy 94-2 function | \$128.46 |
| 11-2113 | 23- Option, 3-3/4" BS, Guarded latch assy 04, 05, 13, 15-3, 16, 17, 30, 37, 38 function | \$143.08 |
| 11-2115 | 23- Option, 3-3/4" BS, Guarded latch assy 24 function | \$143.08 |
| 11-2117 | 23- Option, 3-3/4" BS, Guarded latch assy 44, 50, 54 function | \$143.08 |
| 11-2114 | 23- Option, 3-3/4" BS, Unguarded latch assy 15 function | \$143.08 |
| 11-2118 | 23- Option, 3-3/4" BS, Unguarded latch assy 65, 68 function | \$143.08 |
| 11-2119 | 23- Option, 3-3/4" BS, Unguarded latch assy 94-2 function | \$143.08 |
| 11-2120 | 25- Option, 5" BS, Guarded latch assy 04, 05, 13, 15-3, 16, 17, 30, 37, 38 function | \$150.35 |
| 11-2122 | 25- Option, 5" BS, Guarded latch assy 24 function | \$150.35 |
| 11-2124 | 25- Option, 5" BS, Guarded latch assy 44, 50, 54 function | \$150.35 |
| 11-2121 | 25- Option, 5" BS, Unguarded latch assy 15 function | \$150.35 |
| 11-2125 | 25- Option, 5" BS, Unguarded latch assy 65, 68 function | \$150.35 |
| 11-2126 | 25- Option, 5" BS, Unguarded latch assy 94-2 function | \$150.35 |
| 08-2517 | 41- Option, 3/4" throw, 2-3/4" BS, Guarded latch assy 04, 05, 15, 15-3, 16, 37, 38 function | \$198.47 |
| Bearing Assemblies | | |
| Part No | Description | Price |
| 11-2899 | Bearing assy 04, 05, 13, 15, 15-3, 16, 17, 24, 30, 37, 38, 44, 50, 54, 65, 68 function | \$160.57 |
| 11-2004 | Bearing assy, 31- option, 04, 05, 13, 15, 15-3, 16, 17, 24, 30, 37, 38, 44, 50, 54, 65, 68 function | \$202.31 |
| 11-2005 | Bearing assy, 41- option, 3/4" throw latch 04, 05, 15, 15-3, 16, 37, 38, 68 function | \$179.84 |

| Miscellaneous Parts *specify finish when ordering | | Price |
|---|--|----------|
| * 01-0225 | Cup Washer | \$3.68 |
| * 01-1018 | Countersunk Flat head Screw 10-24 x 1/2" (2" Dr) | \$0.97 |
| 01-1027 | Countersunk Flat head Screw 10-24 x 3/8" (1-3/4" Dr) | \$0.85 |
| * 01-1316 | Spanner set screw - for lever only (bit size #6) | \$3.58 |
| 01-1424 | 6-Lobe security set screw for lever only 1/4-28 x .1675" (bit size T-20) | \$5.29 |
| 01-2201 | Wood Screw #4 x 1/2" | \$0.81 |
| 01-3337 | Machine Screw #4-40 x 1/2" | \$4.30 |
| * 01-4373 | Countersunk Flat Head Screw 1/4-20 x 2-3/4" | \$5.08 |
| 01-4530 | 6-Lobe Security Tool (Torx™) – to assemble lever set screw | \$11.14 |
| * 01-5000 | Countersunk Flat Head Screw 8-32 x 3/4" | \$0.81 |
| * 01-5001 | Subfront Screws (6010 kit) | \$1.11 |
| 01-9109 | Machine Screw #6-32 x 3/8" | \$0.80 |
| * 08-0562 | Subfront (6010 kit) | \$63.70 |
| 11-0031 | Collar inside | \$6.44 |
| 11-0032 | Collar outside | \$9.35 |
| 11-0394 | Aligning pin - standard | \$14.57 |
| 11-0396 | Aligning pin (2-1/4" DOOR) | \$14.57 |
| 11-0397 | Aligning pin (2-1/2" DOOR) | \$14.57 |
| 11-0138 | Installation wrench – to assemble rose & collars | \$8.49 |
| 11-0171 | Cylinder tailpiece - interchangeable core - 6 pin | \$1.66 |
| 11-0172 | Cylinder tailpiece - interchangeable core - 7 pin and 6 pin Sargent removable core | \$1.66 |
| 11-0174 | Anchor Plate | \$0.74 |
| 11-0263 | Threaded Plunger | \$17.52 |
| 11-0266 | Screwdriver | \$5.96 |
| 11-0276 | Cylinder Tailpiece Pack for 11-IC Cores | \$5.96 |
| 11-0403 | Tailpiece (11 Line) for Schlage SF prefix | \$4.50 |
| * 11-2263 | Thumbturn – 68 function | \$42.94 |
| 11-2495 | Mounting Flange Assy. (93 & 94 function) | \$116.78 |
| 11-2496 | Mounting Flange Assy. (94 function) | \$116.78 |
| 11-2501 | Tube Assy. (94-2 function) | \$218.96 |
| 11-2520 | Screw pack | \$17.65 |
| * 11-2521 | 93 & 94 function screw pack | \$22.48 |
| 11-2522 | 36- Screw pack | \$41.76 |
| * 11-2523 | 36- 93 & 94 function screw pack | \$73.87 |
| 11-2524 | 37- Screw pack | \$41.76 |
| * 11-2525 | 37- 93 & 94 function screw pack | \$73.87 |
| 11-2526 | 28- screw pack | \$17.65 |
| 11-2527 | 28-36- screw pack | \$41.76 |
| 11-2528 | 28-37- screw pack | \$41.76 |
| 11-2529 | 41- screw pack | \$17.65 |
| 11-2530 | 41-36 screw pack | \$41.76 |
| 11-2531 | 41-37 screw pack | \$41.76 |
| 11-2578 | Tailpiece pack for 30- option cylinder | \$7.12 |
| 11-5003 | 11 Line "T-Zone" Tail Piece & Retainer Pack | \$8.23 |
| 11-5004 | Cylinder spacer for 6-Pin fixed core Yale® cylinder | \$9.42 |
| 11-5005 | Cylinder tailpiece pack for Yale® 6 or 7-pin LFIC | \$2.04 |
| 13-1385 | Cylinder tailpiece – adapts 10L cylinder to 11L cylinder - standard cylinder | \$2.06 |
| 14-0057 | Emergency key privacy function only | \$1.68 |
| 14-0299 | Lockout key – 50 function | \$4.95 |
| * C11-3 | Emergency Release Cyl. (65 function) | \$52.96 |

BL-16 BORED LOCKS

SARGENT®

ASSA ABLOY

10-LINE OPTIONS



USA & Canada Prices Effective June 3, 2019

| Options | Description | Price |
|---------|--|----------------|
| 1 | Adapter plates for 1-3/8" thick door | \$26.00 |
| 10▲ | SARGENT Signature Key System | \$58.00 / cyl. |
| 11▲ | SARGENT XC Key System (not available with 10, 22, SC, SE options) | No addition |
| 1160▲ | Sargent XC Large Format Interchangeable Plastic Disposable Construction Core | No addition |
| 1163▲ | Sargent XC Large Format Interchangeable Core Cylinder - Includes masterkeying charges | \$77.00 |
| 1164▲ | Sargent XC Large Format Interchangeable Construction Core Cylinder | \$77.00 |
| 1170 | Small Format interchangeable disposable construction core - to accept 7 Pin XC permanent core | No addition |
| 11727P | Small Format interchangeable keyed construction core - to accept 7 Pin XC permanent core | \$69.00 |
| 11737P | Small Format interchangeable core - to accept 7 pin XC permanent core | \$69.00 / cyl. |
| 20 | 2-3/8" backset with 1" front | No addition |
| 21▲ | SARGENT Construction Key System (lost ball) Standard on new systems est. since 5/1/96 | \$16.00 / cyl. |
| 22▲ | SARGENT Construction Key System (split key) For pre-established key systems only | \$32.00 / cyl. |
| 23 | Lockset x 3 - 3/4" Backset | \$10.00 |
| 25 | Lockset x 5" Backset | \$15.00 |
| 28 | Lockset x ANSI A-156.115 Strike – 1-1/4" Lip Standard | |
| | Lip Lengths 1-1/8" or 1-3/8" | No addition |
| | Lip Lengths 1-5/8", 1-7/8", 2-1/8", 2-3/8", 2-5/8", 2-7/8" | \$11.00 |
| 30▲ | Lever to accept Schlage cylinder - no cylinder provided | No addition |
| 36 | 6 Lobe security head screws | \$14.00 |
| 37 | Spanner head screws | \$9.00 |
| 41 | 3/4" Throw with latch | \$98.00 |
| 60▲ | SARGENT Large Format Interchangeable Plastic Disposable Construction Core | No addition |
| 63▲ | SARGENT Large Format IC Core Cylinder includes master and grandmaster keying charge | \$77.00 / cyl |
| 64▲ | SARGENT Large Format Interchangeable Construction Core Cylinder | \$77.00 |
| 6573▲ | Small Format 6 Pin Uncombined Core | \$59.00 / cyl. |
| 65737P▲ | Small Format 7 Pin Uncombined Core | \$59.00 / cyl. |
| 70▲ | Small Format Interchangeable disposable plastic construction core | No addition |
| 72▲ | Small Format interchangeable 6-pin Construction Core (7-Pin w/11-Option) | \$69.00 |
| 73▲ | Small Format Interchangeable Core, 6-Pin Includes MK and GMK keying charges | \$69.00 / cyl. |
| 737P▲ | Small Format Interchangeable Core, 7-Pin Includes MK and GMK keying charges | \$69.00 / cyl. |
| 74 | Lead Lining I/S Rose, O/S Rose, and Latch Tube | \$198.00 /lock |
| 75 | Tactile Warning - Milled on backside of inside lever | \$37.00 |
| 76 | Tactile Warning - Milled on backside of outside lever | \$37.00 |
| 77 | Tactile Warning - Milled on backside of both levers | \$74.00 |
| 80▲ | Levers to accept KESO and Keso F1 cylinders – no cylinders provided | -\$87.00/cyl. |
| F182▲ | SARGENT KESO Security Cylinder – patented – new key systems | \$84.00/cyl. |
| 82▲ | SARGENT KESO Security Cylinder (L,B,P levers only) | \$84.00 / cyl. |
| 85 | Tactile Warning - Abrasive coating on inside lever | \$45.00 |
| 86 | Tactile Warning - Abrasive coating on outside lever | \$45.00 |
| 87 | Tactile Warning - Abrasive coating on both levers | \$90.00 |
| BR | SARGENT Bump Resistant Cyls. (N/A w/10, 22, 30, 60, 63, 64, 70, 72, 73, 737P, KESO, SC, SE) | \$23.00 /cyl. |
| DG1 | Patented Degree DG1 Key System | No Addition |
| DG160 | Hardware prepared for DG1-6300 Lg. Format IC cores, supplied with temporary plastic construction cores | No addition |
| DG163 | Patented Degree DG1 Large Format Interchangeable Core Cylinder - Includes master keying charges | \$77.00 |
| DG164 | Hardware prepared for DG1-6300 Lg. Format IC cores, supplied with temporary keyed construction cores | \$77.00 |
| DG2 | Patented Degree DG2 Key System incorporating a locking sidebar | \$58.00/cyl. |
| DG260 | Hardware prepared for DG2-6300 Lg. Format IC cores, supplied with temporary plastic construction cores | No addition |
| DG263 | Patented Degree DG2 Large Format Interchangeable Core Cylinder - Includes master keying charges | \$135.00 |
| DG264 | Hardware prepared for DG2-6300 Lg. Format IC cores, supplied with temporary keyed construction cores | \$77.00 |
| DG3 | Patented Degree DG3 Key System incorporating a locking sidebar and UL437 listed | \$82.00/cyl. |
| DG360 | Hardware prepared for DG3-6300 Lg. Format IC cores, supplied with temporary plastic construction cores | No addition |
| DG363 | Patented Degree DG3 Large Format Interchangeable Core Cylinder - Includes master keying charges | \$159.00 |
| DG364 | Hardware prepared for DG3-6300 Lg. Format IC cores, supplied with temporary keyed construction cores | \$77.00 |
| FW | Freewheeling Locking Levers L, B, P levers only, not available w/10G70, 10G71 functions | \$8.00 |
| RX | Request to Exit (available with 04, 05, 37, 15, 70-12v & 24v, and 71-12v & 24v) functions | |
| | Handing required when ordering – How to order: RX-10G05 x LL x 26D x RH | \$190.00 |
| LC | Less Cylinder | -\$87.00/cyl. |
| SC▲ | Schlage C Keyway cylinder, 0 bitted | No addition |
| SE▲ | Schlage E Keyway cylinder, 0 bitted | No addition |
| SF | L Lever to accept Schlage Large Format Interchangeable Core (supplied less core, tailpiece included) | No Addition |
| SG | MicroShield® – an antimicrobial powder coat | \$67.00 |
| WBS | Wrought Box Strike | No Addition |

▲ Options NOT available with 50 function.

CPC Clear Powder Coat over 26D – 10G05 x GL x 26D x CPC \$62.00
All orders will continue to be handled as a "special" when CPC is ordered.

USA & Canada Prices Effective June 3, 2019

| Rose Design: | | Lever Design: | |  |  |  |
|---|---|-------------------------------------|----------|---|--|---|
| G Rose L Rose | | L – Lever B – Lever P – Lever | | GL | LB | GP |
| | | | | “G” Rose with “L” Lever | “L” Rose with “B” Lever | “G” Rose with “P” Lever |
| Function | | Finish | | | | |
| Single Cylinder | | 10BE/26D/BSP/WSP | | 03/04/09/10/10B/10BL/14/15/2 | | |
| 10G04 | Storeroom/Closet | | | | | |
| 10G05 | Entry/Office | | \$648.00 | | | \$664.00 |
| 10G37 | Classroom | | | | | |
| 10G24 | Entry | | \$662.00 | | | \$678.00 |
| 10G44 | Service Station | | | | | |
| 10G50 | Hotel | | \$719.00 | | | \$735.00 |
| 10G54 | Dormitory | | | | | |
| Double Cylinder | | | | | | |
| 10G16 | Classroom Security/Public Entrance | | | | | |
| 10G17 | Utility/Asylum/Institutional | | | | | |
| 10G26 | Storeroom | | \$745.00 | | | \$761.00 |
| 10G30 | Communicating | | | | | |
| 10G38 | Classroom security | | | | | |
| Non Keyed | | | | | | |
| 10U15 | Passage | | \$465.00 | | | \$481.00 |
| 10G13 | Exit | | | | | |
| 10G15-3 | Exit | | | | | |
| 10U65 | Privacy | | \$546.00 | | | \$562.00 |
| 10U68 | Hospital Privacy | | | | | |
| 10U93 | 1/2 Dummy Trim | | \$201.00 | | | \$209.00 |
| 10U94 | Dummy Trim | | \$403.00 | | | \$419.00 |
| 10U94-2 | Dummy Trim | | \$408.00 | | | \$424.00 |
| Electro-Mechanical | | | | | | |
| 10G70-12V / 10G70-24V | Fail Safe | | \$944.00 | | | \$960.00 |
| 10G71-12V / 10G71-24V | Fail Secure | | | | | |
| Strikes - See catalog for available lip lengths | | Specify Finish | | | | |
| 800 | ANSI A115.2 T Strike (Standard) Lip Lengths available: 1", 1-1/4" (Standard), 1-1/2", 1-3/4", 2" | | | | | Refer to page BL-47 |
| 808 | ANSI A115.2 – 4-7/8" Strike (Option 28-) Lip Lengths available: 1-1/8", 1-1/4" (Standard), 1-3/8", 1-5/8", 1-7/8", 2-1/8", 2-3/8", 2-5/8", 2-7/8" | | | | | Refer to page BL-47 |
| AM-0044 | Strike Box (Standard) | | | | | \$10.80 |
| 77-1141 | Strike Box (Option 28-) | | | | | \$10.80 |

Note: Split finishes are available, price as higher finish. Order outside/inside and handing must be specified. Strike and latch front will match inside finish for RH/LH and outside finish for RHR/LHR.

BL-18 BORED LOCKS

SARGENT®



ASSA ABLOY

10-LINE OPTIONS

USA & Canada Prices Effective June 3, 2019

| Options | Description | Price |
|---------|--|----------------|
| 1 | Adapter plates for 1-3/8" thick door | \$26.00 |
| 10▲ | SARGENT Signature Key System | \$58.00 / cyl. |
| 11▲ | SARGENT XC Key System (not available with 10, 22, SC, SE options) | No addition |
| 1160▲ | Sargent XC Large Format Interchangeable Plastic Disposable Construction Core | No addition |
| 1163▲ | Sargent XC Large Format Interchangeable Core Cylinder - Includes masterkeying charges | \$77.00 |
| 1164▲ | Sargent XC Large Format Interchangeable Construction Core Cylinder | \$77.00 |
| 20 | 2-3/8" backset with 1" front | No addition |
| 21▲ | SARGENT Construction Key System (lost ball) Standard on new systems est. since 5/1/96 | \$16.00 / cyl. |
| 22▲ | SARGENT Construction Key System (split key) For pre-established key systems only | \$32.00 / cyl. |
| 23 | Lockset x 3 - 3/4" Backset | \$10.00 |
| 25 | Lockset x 5" Backset | \$15.00 |
| 28 | Lockset x ANSI A-156.115 Strike – 1-1/4" Lip Standard Lip Lengths 1-1/8" or 1-3/8" | No addition |
| | Lip Lengths 1-5/8", 1-7/8", 2-1/8", 2-3/8", 2-5/8", 2-7/8" | \$11.00 |
| 30 | 10 Line lever to accept Schlage cylinder - no cylinder provided | No addition |
| 36 | 6 Lobe security head screws | \$14.00 |
| 37 | Spanner head screws | \$9.00 |
| 41 | 3/4" Throw with latch | \$98.00 |
| 60▲ | SARGENT Large Format Interchangeable Plastic Disposable Construction Core | No addition |
| 63▲ | SARGENT Large Format Interchangeable Core Cylinder includes master and grandmaster keying charge | \$77.00 / cyl. |
| 64▲ | SARGENT Large Format Interchangeable Construction Core Cylinder | \$77.00 |
| 74 | Lead Lining I/S Rose, O/S Rose, and Latch Tube | \$198.00 /lock |
| 75 | Tactile Warning - Milled on backside of inside lever | \$37.00 |
| 76 | Tactile Warning - Milled on backside of outside lever | \$37.00 |
| 77 | Tactile Warning - Milled on backside of both levers | \$74.00 |
| 85 | Tactile Warning - Abrasive coating on inside lever | \$45.00 |
| 86 | Tactile Warning - Abrasive coating on outside lever | \$45.00 |
| 87 | Tactile Warning - Abrasive coating on both levers | \$90.00 |
| BR | SARGENT Bump Resistant Cyls. (N/A w/10, 22, 30, 60, 63, 64, 70, 72, 73, 737P, KESO, SC, SE) | \$23.00 /cyl. |
| DG1 | Patented Degree DG1 Key System | No Addition |
| DG160 | Hardware prepared for DG1-6300 Lg. Format IC cores, supplied with temporary plastic construction cores | No addition |
| DG163 | Patented Degree DG1 Large Format Interchangeable Core Cylinder - Includes master keying charges | \$77.00 |
| DG164 | Hardware prepared for DG1-6300 Lg. Format IC cores, supplied with temporary keyed construction cores | \$77.00 |
| DG2 | Patented Degree DG2 Key System incorporating a locking sidebar | \$58.00/cyl. |
| DG260 | Hardware prepared for DG2-6300 Lg. Format IC cores, supplied with temporary plastic construction cores | No addition |
| DG263 | Patented Degree DG2 Large Format Interchangeable Core Cylinder - Includes master keying charges | \$135.00 |
| DG264 | Hardware prepared for DG2-6300 Lg. Format IC cores, supplied with temporary keyed construction cores | \$77.00 |
| DG3 | Patented Degree DG3 Key System incorporating a locking sidebar and UL437 listed | \$82.00/cyl. |
| DG360 | Hardware prepared for DG3-6300 Lg. Format IC cores, supplied with temporary plastic construction cores | No addition |
| DG363 | Patented Degree DG3 Large Format Interchangeable Core Cylinder - Includes master keying charges | \$159.00 |
| DG364 | Hardware prepared for DG3-6300 Lg. Format IC cores, supplied with temporary keyed construction cores | \$77.00 |
| LC | Less Cylinder | -\$87.00/cyl. |
| RX | Request to Exit (available with 04, 05, 37, 15, 70-12v & 24v, and 71-12v & 24v) functions Handing required when ordering – How to order: RX-10G05 x LL x 26D x RH | \$190.00 |
| SC▲ | Schlage C Keyway cylinder, 0 bitted | No Addition |
| SE▲ | Schlage E Keyway cylinder, 0 bitted | No Addition |
| SG | MicroShield® – an antimicrobial powder coat | \$67.00 |
| WBS | Wrought Box Strike | No Addition |
| ▲ | Options <u>NOT</u> available with 50 function. | |
| CPC | Clear Powder Coat over 26D – 10G05 x LJ x 26D x CPC All orders will continue to be handled as a "special" when CPC is ordered. | \$62.00 |

USA & Canada Prices Effective June 3, 2019

| Function | | Finish | |
|--|---|---|--|
| | | 10BE/26D/BSP/WSP | 03/04/09/10/10B/10BL/14/15/20D/26 |
| Rose Design: G Rose L Rose | | Lever Design: J – Lever | |
| | |  LJ “L” Rose with “J” Lever |  GJ “G” Rose with “J” Lever |
| Single Cylinder | | | |
| 10G04 | Storeroom | | |
| 10G05 | Office | \$667.00 | \$683.00 |
| 10G37 | Classroom | | |
| 10G24 | Dormitory | \$685.00 | \$701.00 |
| 10G44 | Service Station | | |
| 10G50 | Hotel | \$753.00 | \$769.00 |
| 10G54 | Dormitory | | |
| Double Cylinder | | | |
| 10G16 | Public Entrance | | |
| 10G17 | Asylum | | |
| 10G26 | Storeroom | \$787.00 | \$803.00 |
| 10G30 | Communicating | | |
| 10G38 | Classroom Security | | |
| Non Keyed | | | |
| 10U15 | Passage | \$484.00 | \$500.00 |
| 10G13 | Exit | | |
| 10G15-3 | Exit | \$554.00 | \$570.00 |
| 10U65 | Privacy | | |
| 10U93 | 1/2 Dummy Trim | \$210.00 | \$218.00 |
| 10U94 | Dummy Trim | \$425.00 | \$441.00 |
| 10U94-2 | Dummy Trim | \$430.00 | \$446.00 |
| Electro-Mechanical | | | |
| 10G70-12V / 10G70-24V | Fail Safe | \$961.00 | \$977.00 |
| 10G71-12V / 10G71-24V | Fail Secure | | |
| Strikes - See catalog for available lip lengths | | Specify Finish | |
| 800 | ANSI A115.2 T Strike (Standard) Lip Lengths available: 1", 1-1/4" (Standard), 1-1/2", 1-3/4", 2" | | Refer to page BL-47 |
| 808 | ANSI A115.2 – 4-7/8" Strike (Option 28-) Lip Lengths available: 1-1/8", 1-1/4" (Standard), 1-3/8", 1-5/8", 1-7/8", 2-1/8", 2-3/8", 2-5/8", 2-7/8" | | Refer to page BL-47 |
| AM -0044 | Strike Box (Standard) | | \$10.80 |
| 77-1141 | Strike Box (Option 28-) | | \$10.80 |

Note: Split finishes are available, price as higher finish. Order outside/inside and handing must be specified. Strike and latch front will match inside finish for RH/LH and outside finish for RHR/LHR.

10-LINE COASTAL SERIES OPTIONS

USA & Canada Prices Effective June 3, 2019

| Options | Description | Price |
|---------|--|----------------|
| 1 | Adapter plates for 1-3/8" thick door | \$26.00 |
| 10▲ | SARGENT Signature Key System | \$58.00 / cyl. |
| 11▲ | SARGENT XC Key System (not available with 10, 22, SC, SE options) | No addition |
| 1160▲ | Sargent XC Large Format Interchangeable Plastic Disposable Construction Core | No addition |
| 1163▲ | Sargent XC Large Format Interchangeable Core Cylinder - Includes masterkeying charges | \$77.00 |
| 1164▲ | Sargent XC Large Format Interchangeable Construction Core Cylinder | \$77.00 |
| 1170 | Small Format interchangeable disposable construction core - to accept 7 Pin XC permanent core | No addition |
| 11727P | Small Format interchangeable keyed construction core - to accept 7 Pin XC permanent core | 69 |
| 11737P | Small Format interchangeable core - to accept 7 pin XC permanent core | \$69.00 |
| 20 | 2-3/8" backset with 1" front | No addition |
| 21▲ | SARGENT Construction Key System (lost ball) Standard on new systems est. since 5/1/96 | \$16.00 / cyl. |
| 22▲ | SARGENT Construction Key System (split key) For pre-established key systems only | \$32.00 / cyl. |
| 23 | Lockset x 3 - 3/4" Backset | \$10.00 |
| 25 | Lockset x 5" Backset | \$15.00 |
| 28 | Lockset x ANSI A-156.115 Strike – 1-1/4" Lip Standard Lip Lengths 1-1/8" or 1-3/8" | No addition |
| | Lip Lengths 1-5/8", 1-7/8", 2-1/8", 2-3/8", 2-5/8", 2-7/8" | \$11.00 |
| 30 | Lever to accept Schlage cylinder - no cylinder provided | No addition |
| 36 | 6 Lobe security head screws | \$14.00 |
| 37 | Spanner head screws | \$9.00 |
| 41 | 3/4" Throw with latch | \$98.00 |
| 60▲ | SARGENT Large Format Interchangeable Plastic Disposable Construction Core | No addition |
| 63▲ | SARGENT Large Format Interchangeable Core Cylinder includes master and grandmaster keying charge | \$77.00 / cyl. |
| 64▲ | SARGENT Large Format Interchangeable Construction Core Cylinder | \$77.00 |
| 70 | Small Format interchangeable disposable plastic construction core | No addition |
| 72 | Small Format interchangeable 6-Pin construction core | \$69.00 |
| 73 | Small Format interchangeable core 6-pin Includes MK and GMK keying charges | \$69.00 |
| 737P | Small Format interchangeable core 7-pin (refer to CK-12 for available keyways) Includes MK and GMK keying charges | \$69.00 |
| 74 | Lead Lining I/S Rose, O/S Rose, and Latch Tube | \$198.00 /lock |
| 80▲ | Levers to accept KESO and Keso F1 cylinders – no cylinders provided | -\$87.00/cyl. |
| F182▲ | SARGENT KESO Security Cylinder – patented – new key systems | \$84.00 /cyl. |
| 82▲ | SARGENT KESO Security Cylinder (L,B,P levers only) | \$84.00 / cyl. |
| 85 | Tactile Warning - Abrasive coating on inside lever | \$45.00 |
| 86 | Tactile Warning - Abrasive coating on outside lever | \$45.00 |
| 87 | Tactile Warning - Abrasive coating on both levers | \$90.00 |
| BR | SARGENT Bump Resistant Cyls. (N/A w/10, 22, 30, 60, 63, 64, 70, 72, 73, 737P, KESO, SC, SE) | \$23.00 /cyl. |
| DG1 | Patented Degree DG1 Key System | No Addition |
| DG160 | Hardware prepared for DG1-6300 Lg. Format IC cores, supplied with temporary plastic construction cores | No addition |
| DG163 | Patented Degree DG1 Large Format Interchangeable Core Cylinder - Includes master keying charges | \$77.00 |
| DG164 | Hardware prepared for DG1-6300 Lg. Format IC cores, supplied with temporary keyed construction cores | \$77.00 |
| DG2 | Patented Degree DG2 Key System incorporating a locking sidebar | \$58.00/cyl. |
| DG260 | Hardware prepared for DG2-6300 Lg. Format IC cores, supplied with temporary plastic construction cores | No addition |
| DG263 | Patented Degree DG2 Large Format Interchangeable Core Cylinder - Includes master keying charges | \$135.00 |
| DG264 | Hardware prepared for DG2-6300 Lg. Format IC cores, supplied with temporary keyed construction cores | \$77.00 |
| DG3 | Patented Degree DG3 Key System incorporating a locking sidebar and UL437 listed | \$82.00/cyl. |
| DG360 | Hardware prepared for DG3-6300 Lg. Format IC cores, supplied with temporary plastic construction cores | No addition |
| DG363 | Patented Degree DG3 Large Format Interchangeable Core Cylinder - Includes master keying charges | \$159.00 |
| DG364 | Hardware prepared for DG3-6300 Lg. Format IC cores, supplied with temporary keyed construction cores | \$77.00 |
| FW | Freewheeling Locking Levers – Not available w/10G70, 10G71 functions | \$8.00 |
| LC | Less Cylinder | -\$87.00/cyl. |
| RX | Request to Exit (available with 04, 05, 37, 15, 70-12v & 24v, and 71-12v & 24v) functions Handing required when ordering – How to order: RX-10G05 x LL x 26D x RH | \$190.00 |
| SC▲ | Schlage C Keyway cylinder, 0 bitted | No Addition |
| SE▲ | Schlage E Keyway cylinder, 0 bitted | No Addition |
| SG | MicroShield® – an antimicrobial powder coat | \$67.00 |
| WBS | Wrought Box Strike | No Addition |
| ▲ | Options <u>NOT</u> available with 50 function. | |
| CPC | Clear Powder Coat over 26D – 10G05 x GY x 26D x CPC All orders will continue to be handled as a "special" when CPC is ordered. | \$62.00 |

USA & Canada Prices Effective June 3, 2019

| | | | |
|---|--|---|--|
| Rose Design: G – Rose L – Rose | Lever Design: *Y – Lever *G – Lever *Handed – Specify hand when ordering |  <p>GY “G” Rose with “Y” Lever</p> |  <p>GG “G” Rose with “G” Lever</p> |
|---|--|---|--|

| Function | Finish | |
|--|------------------|------------------------------|
| | 10BE/26D/BSP/WSP | 03/04/09/10/10B/10BL/14/15/2 |
| Single Cylinder | | |
| 10G04 Storeroom/Closet | | |
| 10G05 Entry/Office | \$667.00 | \$683.00 |
| 10G37 Classroom | | |
| 10G24 Entry | \$685.00 | \$701.00 |
| 10G44 Service Station | | |
| 10G50 Hotel | \$753.00 | \$769.00 |
| 10G54 Dormitory | | |
| Double Cylinder | | |
| 10G16 Classroom Security/Public Entrance | | |
| 10G17 Utility/Asylum/Institutional | | |
| 10G26 Storeroom | \$787.00 | \$803.00 |
| 10G30 Communicating | | |
| 10G38 Classroom security | | |
| Non Keyed | | |
| 10U15 Passage | \$484.00 | \$500.00 |
| 10G13 Exit | | |
| 10G15-3 Exit | | |
| 10U65 Privacy | \$554.00 | \$570.00 |
| 10U68 Hospital Privacy | | |
| 10U93 1/2 Dummy Trim | \$210.00 | \$218.00 |
| 10U94 Dummy Trim | \$425.00 | \$441.00 |
| 10U94-2 Dummy Trim | \$430.00 | \$446.00 |
| Electro-Mechanical | | |
| 10G70-12V / 10G70-24V Fail Safe | \$961.00 | \$977.00 |
| 10G71-12V / 10G71-24V Fail Secure | | |

| Strikes - See catalog for available lip lengths | | Specify Finish |
|---|--|---------------------|
| 800 | ANSI A115.2 T Strike (Standard) Lip Lengths available: 1", 1-1/4" (Standard), 1-1/2", 1-3/4", 2" | Refer to page BL-47 |
| 808 | ANSI A115.2 – 4-7/8" Strike (Option 28-) Lip Lengths available: 1-1/8", 1-1/4" (Standard), 1-3/8", 1-5/8", 1-7/8", 2-1/8", 2-3/8", 2-5/8", 2-7/8" | Refer to page BL-47 |
| AM-0044 | Strike Box (Standard) | \$10.80 |
| 77-1141 | Strike Box (Option 28-) | \$10.80 |

Note: Split finishes are available, price as higher finish. Order outside/inside and handing must be specified. Strike and latch front will match inside finish for RH/LH and outside finish for RHR/LHR.

BL-22 BORED LOCKS

SARGENT®

10-LINE LEVERS

ASSA ABLOY

USA & Canada Prices Effective June 3, 2019

| <u>Lever Handles</u> | | Finish |
|----------------------|---|--|
| Part # | Description (Inside or Outside) | 03/04/09/10/10B/10BE/10BL/14/15/20D/26/26D/BSP/WSP |
| 10-0501 | "L" design, Passage | |
| 10-0502 | "L" design, Cylinder, Emergency Release (65) | |
| 10-0503 | "L" design, All Buttons | |
| 10-0504 | "L" design prepared for SARGENT Removable core cylinder | |
| 10-0506 | "L" design prepared for SARGENT KESO 82- cylinder | |
| 10-0507 | "L" design prepared for SF- option Schlage LFIC | |
| 10-0505 | "L" design prepared for Interchangeable core cylinder 70- | |
| 10-0545 | "P" design, Passage | |
| 10-0546 | "P" design, Cylinder, Emergency Release (65) | |
| 10-0547 | "P" design, Turn Button, T-Turn and 30- option | |
| 10-0548 | "P" design prepared for SARGENT Removable core cylinder | |
| 10-0550 | "P" design prepared for SARGENT KESO 82- cylinder | |
| 10-0549 | "P" design prepared for Interchangeable core cylinder 72- | \$71.00 |
| 10-0523 | "B" design, Passage | |
| 10-0524 | "B" design, Cylinder, Emergency Release (65) | |
| 10-0525 | "B" design, Turn Button, T-Turn and 30- option | |
| 10-0526 | "B" design prepared for SARGENT Removable core cylinder | |
| 10-0528 | "B" design prepared for SARGENT KESO 82- cylinder | |
| 10-0527 | "B" design prepared for Interchangeable core cylinder 72- | |
| 10-2204 | "J" design, Passage | |
| 10-2205 | "J" design, Cylinder, Emergency Release (65) | \$79.00 |
| 10-2206 | "J" design, Turn Button, T-Turn and 30- option | |
| 10-2207 | "J" design prepared for SARGENT Removable core cylinder 60- | |

| <u>Lever Handles w/Handicap Warning</u> | | Finish |
|---|---|--|
| Part # | Description (Inside or Outside) | 03/04/09/10/10B/10BE/10BL/14/15/20D/26/26D/BSP/WSP |
| 10-0512 | "L" design, Passage | |
| 10-0513 | "L" design, Cylinder, Emergency Release (65) | |
| 10-0514 | "L" design, Turn Button, T-Turn and 30- option | |
| 10-0515 | "L" design prepared for SARGENT Removable core cylinder | |
| 10-0516 | "L" design prepared for SARGENT Interchangeable 72- core cylinder | |
| 10-0517 | "L" design prepared for SARGENT KESO 82- cylinder | |
| 10-0518 | "L" design prepared for LFIC/SC SFIC | |
| 10-0556 | "P" design, Passage | |
| 10-0557 | "P" design, Cylinder, Emergency Release (65) | |
| 10-0558 | "P" design, Turn Button, T-Turn and 30- option | |
| 10-0559 | "P" design prepared for SARGENT Removable core cylinder | |
| 10-0560 | "P" design prepared for SARGENT Interchangeable 72- core cylinder | |
| 10-0561 | "P" design prepared for SARGENT KESO 82- cylinder | \$109.00 |
| 10-2245 | "J" design, Passage | |
| 10-2246 | "J" design, Cylinder, Emergency Release (65) | |
| 10-2247 | "J" design, Turn Button, T-Turn and 30- option | |
| 10-2248 | "J" design prepared for SARGENT Removable core cylinder | |
| 10-0534 | "B" design, Passage | |
| 10-0535 | "B" design, Cylinder, Emergency Release (65) | |
| 10-0536 | "B" design, Turn Button, T-Turn and 30- option | |
| 10-0537 | "B" design prepared for SARGENT Removable core cylinder | |
| 10-0538 | "B" design prepared for SARGENT Interchangeable 72- core cylinder | |
| 10-0539 | "B" design prepared for SARGENT KESO 82- cylinder | |

10-LINE COASTAL SERIES LEVERS

USA & Canada Prices Effective June 3, 2019

| Lever Handles - Coastal Series Design | | Finish |
|--|---|---|
| Part # | Description (Inside or Outside) | 03/04/09/10/10B/10BE/10BL/14/15/20D/26/26D/BSP/WSP |
| 10-0611 | "Y" design, Passage - Left | |
| 10-0612 | "Y" design, Passage - Right | |
| 10-0613 | "Y" design, Cylinder and emergency release (65) - Left | |
| 10-0614 | "Y" design, Cylinder and emergency release (65) - Right | |
| 10-0615 | "Y" design, Turn Button, T-Turn and 30- option - Left | |
| 10-0616 | "Y" design, Turn Button, T-Turn and 30- option - Right | |
| 10-0617 | "Y" design prepared for SARGENT Removable core cylinder - Left | |
| 10-0618 | "Y" design prepared for SARGENT Removable core cylinder - Right | |
| 10-0619 | "Y" design prepared for SARGENT Interchangeable 72- core cylinder - Left | |
| 10-0620 | "Y" design prepared for SARGENT Interchangeable 72- core cylinder - Right | |
| 10-0621 | "Y" design prepared for SARGENT KESO 82- cylinder - Left | |
| 10-0622 | "Y" design prepared for SARGENT KESO 82- cylinder - Right | |
| 10-0567 | "G" design, Passage - Left | \$71.00 |
| 10-0568 | "G" design, Passage - Right | |
| 10-0569 | "G" design, Cylinder and emergency release (65)- Left | |
| 10-0570 | "G" design, Cylinder and emergency release (65)- Right | |
| 10-0571 | "G" design, Turn Button, T-Turn and 30- option - Left | |
| 10-0572 | "G" design, Turn Button, T-Turn and 30- option - Right | |
| 10-0573 | "G" design prepared for SARGENT Removable core cylinder - Left | |
| 10-0574 | "G" design prepared for SARGENT Removable core cylinder - Right | |
| 10-0575 | "G" design prepared for SARGENT Interchangeable 72- core cylinder - Left | |
| 10-0576 | "G" design prepared for SARGENT Interchangeable 72- core cylinder - Right | |
| 10-0577 | "G" design prepared for SARGENT KESO 82- cylinder - Left | |
| 10-0578 | "G" design prepared for SARGENT KESO 82- cylinder - Right | |

| Lock Replacement Kits - For 7600 Integra Locks (See catalog) | | Finish | |
|---|--|--|---------------------|
| Number | Description | 10BE/26D BSP/WSP10BL/20D/26 | 03/04/10/10B |
| * 6010 | For replacing 7600 with C768 or C769 strike Specify 6010 x 800 to replace 762 strike. | \$92.00 | \$101.00 |
| 6011 | Lock replacement units – larger cover plates | \$211.00 | \$225.00 |
| 6012 | Lock replacement units – larger cover plates | | |

* Retro fits lock fronts with front face of 4-1/4" x 1-1/4" and strikes 2-3/4" high (800) and 4-7/8" high (808).

Note: Must specify if intending to use with 10-Line lockset.

BL-24 BORED LOCKS

SARGENT®

10-LINE ROSES/LATCHES/ASSEMBLIES

ASSA ABLOY

USA & Canada Prices Effective June 3, 2019

| Roses | 10BE/26D/BSP/WSP | 03/04/09/10/10B/10BL/14/15/20D/26 |
|---|---|--|
| 10-0798 Inside and outside Rose Scalp – L | \$44.61 | \$66.89 |
| 10-0790 Inside and outside Rose Scalp – G | \$61.75 | \$84.09 |
| 10-3048 Inside Rose Spring Assy. (not finished) | \$77.24 | \$77.24 |
| 10-3049 Outside Rose Spring Assy. (not finished) | \$78.37 | \$78.37 |
| 10-3050 Rose Spring Assy. (10G15-3) function only | \$61.75 | \$84.09 |
| Latch Units | | |
| Standard 2-3/4" Backset | | 03/04/09/10/10B/10BE/10BL/20D/32D/BSP/WSP |
| 10-3192 Guarded Latch | | \$59.26 |
| 10-2022 Unguarded Latch | | \$56.17 |
| 20 Option 2-3/8" Backset | | 03/04/09/10/10B/10BE/10BL/20D/32D/BSP/WSP |
| 10-3186 Guarded Latch 2-3/8" | | \$71.40 |
| 10-3187 Unguarded Latch 2-3/8" | | \$67.08 |
| 23 Option 3-3/4" Backset | | 03/04/09/10/10B/10BE/10BL/20D/32D/BSP/WSP |
| 10-2053 Guarded Latch | | \$85.56 |
| 10-2054 Unguarded Latch | | \$82.95 |
| 25 Option 5" Backset | | 03/04/09/10/10B/10BE/10BL/20D/32D/BSP/WSP |
| 10-2058 Guarded Latch | | \$98.73 |
| 10-2057 Unguarded Latch | | \$96.11 |
| 41 Option 2-3/4" Backset with 3/4" Throw | | 04/26D |
| 10-2634 Guarded Latch | | \$131.02 |
| Extension Only | | |
| 10-2059 3-3/4" Extension (add to 2-3/4" BS Latchbolt) 23- option | | \$52.68 |
| 10-2060 5" Extension (add to 2-3/4" BS Latchbolt) 25- option | | \$52.68 |
| 10-0048 Extension Cover Sleeve (Plastic) | | \$4.48 |
| Lock Body Assemblies For non-cylinder and standard cylinder and 10-, 21-, 22-, 30-, SC-, & SE- options | | |
| Part # | Function | Specify Finish |
| 10-2538 | 04 | |
| * 10-2543 | 05 | |
| 10-2547 | 13 | |
| 10-2548 | 15 | |
| 10-3054 | 15-3 | |
| 10-2550 | 16 | |
| 10-2555 | 17 | |
| * 10-2560 | 24 | \$277.92 |
| 10-3095 | 26 | |
| 10-2565 | 30 | |
| 10-2570 | 37 | |
| 10-3035 | 38 | |
| * 10-2575 | 44 | |
| * 10-2579 | 50 | |
| * 10-2581 | 54 | |
| * 10-3044 | 68 – emergency turn button not included | |
| 10-2587 | 70 | |
| 10-2592 | 71 | \$498.99 |

10-LINE LOCKBODY ASSEMBLIES

USA & Canada Prices Effective June 3, 2019

Lock Body Assemblies To Accept SARGENT Removable Core Cylinders (60-, 63-, 64-Options)

| Part # | Function | Specify Finish |
|-----------|----------|----------------|
| 10-2539 | 04 | |
| * 10-2544 | 05 | |
| 10-2551 | 16 | |
| 10-2556 | 17 | |
| * 10-2561 | 24 | |
| 10-3096 | 26 | \$284.79 |
| 10-2566 | 30 | |
| 10-2571 | 37 | |
| 10-3036 | 38 | |
| * 10-2576 | 44 | |
| * 10-2582 | 54 | |
| 10-2588 | 70 | |
| 10-2593 | 71 | \$505.86 |

Lock Body Assemblies To Accept SARGENT KESO Cylinder (82-Option)

| Part # | Function | Specify Finish |
|-----------|----------|----------------|
| 10-2541 | 04 | |
| * 10-2546 | 05 | |
| 10-2553 | 16 | |
| 10-2558 | 17 | |
| * 10-2563 | 24 | |
| 10-3098 | 26 | \$289.97 |
| 10-2568 | 30 | |
| 10-2573 | 37 | |
| 10-3038 | 38 | |
| * 10-2578 | 44 | |
| * 10-2584 | 54 | |
| 10-2590 | 70 | |
| 10-2595 | 71 | \$511.03 |

Lock Body Assemblies To Accept Arrow, Best, Falcon Interchangeable core Cylinders

| Part # | Function | (70-, 72-, 65-73-, 65-73-7P, 73, 73-7P)* | Specify Finish |
|-----------|----------|--|----------------|
| 10-2540 | 04 | | |
| * 10-2545 | 05 | | |
| 10-2552 | 16 | | |
| 10-2557 | 17 | | |
| * 10-2562 | 24 | | |
| 10-3097 | 26 | | \$289.97 |
| 10-2567 | 30 | | |
| 10-2572 | 37 | | |
| 10-3037 | 38 | | |
| * 10-2577 | 44 | | |
| * 10-2583 | 54 | | |
| 10-2589 | 70 | | |
| 10-2594 | 71 | | \$511.03 |

* Order by Finish 03/04/09/10/10B/10BE/10BL/15/20D/26/26D

BL-26 BORED LOCKS

SARGENT®

10-LINE FW LOCKBODY ASSEMBLIES

ASSA ABLOY

USA & Canada Prices Effective June 3, 2019

| Freewheel Lock body Assy for non-cylinder and standard cylinder (10, 11, 21, 22, SC, SE option) | | Specify Finish |
|--|--|----------------|
| Part # | Function | |
| 10-2686 | 04 | |
| * 10-2691 | 05 | |
| 10-3085 | 13 | |
| 10-3086 | 16 | |
| 10-3090 | 17 | |
| * 10-2707 | 24 | |
| 10-3099 | 26 | \$290.40 |
| 10-3103 | 30 | |
| 10-2717 | 37 | |
| * 10-3112 | 44 | |
| * 10-3116 | 50 | |
| * 10-3117 | 54 | |
| * 10-3121 | 65, 68 – order emergency button separately | |
| Freewheel Lockbody Assy to accept SARGENT Removable Core Cylinders (51, 52, 60, 63, 64 option) | | |
| 10-2687 | 04 | |
| * 10-2692 | 05 | |
| 10-3087 | 16 | |
| 10-3091 | 17 | |
| * 10-2708 | 24 | |
| 10-3100 | 26 | \$297.26 |
| 10-3104 | 30 | |
| 10-2718 | 37 | |
| * 10-3113 | 44 | |
| * 10-3118 | 54 | |
| Freewheel Lockbody Assy to accept Interchangeable Core Cylinders (65-73, 65-73-7P, 70, 72, 73, 73-7P option) | | |
| 10-2688 | 04 | |
| * 10-2693 | 05 | |
| 10-3088 | 16 | |
| 10-3092 | 17 | |
| * 10-2709 | 24 | |
| 10-3101 | 26 | \$302.42 |
| 10-3105 | 30 | |
| 10-2719 | 37 | |
| 10-3114 | 44 | |
| * 10-3119 | 54 | |
| Freewheel Lockbody Assy to accept SARGENT KESO cylinder (82 option) | | |
| 10-3083 | 04 | |
| * 10-3084 | 05 | |
| 10-3089 | 16 | |
| 10-3093 | 17 | |
| * 10-3094 | 24 | |
| 10-3102 | 26 | \$302.42 |
| 10-3106 | 30 | |
| 10-3107 | 37 | |
| * 10-3115 | 44 | |
| * 10-3120 | 54 | |
| Lock Body Assemblies For SF option | | |
| 10-3157 | 04 | |
| * 10-3158 | 05 | |
| 10-3159 | 16 | |
| 10-3160 | 17 | |
| * 10-3161 | 24 | |
| 10-3162 | 26 | \$284.79 |
| 10-3163 | 30 | |
| 10-3164 | 37 | |
| 10-3165 | 38 | |
| * 10-3166 | 44 | |
| * 10-3167 | 54 | |
| 10-3168 | 70 | \$505.86 |
| 10-3169 | 71 | |
| Lock Body Assemblies For FW&SF option | | |
| 10-3175 | 04 | |
| * 10-3176 | 05 | |
| 10-3177 | 16 | |
| 10-3178 | 17 | |
| * 10-3179 | 24 | |
| 10-3180 | 26 | \$297.26 |
| 10-3181 | 30 | |
| 10-3182 | 37 | |
| 10-3183 | 38 | |
| * 10-3184 | 44 | |
| * 10-3185 | 54 | |

| Miscellaneous | | Price |
|---------------|--|---------|
| 01-0949 | Washer only (30- option) for cylinder (order 2 per lock) | \$0.81 |
| 01-4414 | Screw Phillips Pan-head #6 x 3/4" (order 4 per lock) | \$0.32 |
| *08-2842 | Dummy Front (94-2 function) | \$19.36 |
| 10-0019 | Cylinder Spacer (white plastic disk) | \$0.64 |
| 10-0042 | Lockout Key (50 function-for inside push button only) | \$3.59 |
| 10-0043 | Push Pin Tool | \$0.54 |
| 10-0055 | Spring (13 function) | \$0.91 |
| 10-0056 | Lever Catch Plug Key - 13 function (long push pin tool) | \$2.56 |
| 10-0195 | Retractor spring for lockbody (all functions, inside lockbody - 2 per lock) | \$0.79 |
| 10-0239 | 6-Pin Tailpiece (Removable & Interchangeable Cores) | \$1.85 |
| 10-0240 | 7-Pin Tailpiece (Interchangeable Core) | \$1.79 |
| 10-0288 | Lead Lining Plate for Rose (1) | \$12.47 |
| 10-0312 | Cylinder Retainer (required for cylinder lever - standard) - plastic | \$1.56 |
| 10-0792 | Spacer Bushing | \$2.36 |
| 10-0833 | Screw Retainer | \$0.33 |
| *10-2052 | Screw Pack (Standard) - for (2) latchbolt, (2) strike, & (2) surface screws | \$4.69 |
| *10-2070 | Screw Pack (28 Option) - for (2) latchbolt, (2) strike, & (2) surface screws | \$1.88 |
| 10-2071 | Screw Pack (Dummy Trim - 94 & 94-2 function) | \$1.56 |
| 10-2078 | Key Cam Ext. & Pin Assy. (Removable Core - standard) | \$19.03 |
| 10-2090 | Cyl. Retainer & Washer Pack (30- Option) | \$8.61 |
| 10-2185 | Key Cam Ext. & Pin Assy. (Removable Core - 54 function only) | \$19.03 |
| 10-3122 | 10U93 Support Plate | \$56.02 |
| 10-3123 | 10U94 Outside Support Plate | \$57.55 |
| 10-3124 | 10U94 Inside Support Plate | \$66.64 |
| 10-3138 | Cylinder Tailpiece Pack for 11-IC cores | \$6.18 |
| 10-3188 | Adapter plate pack, 1-3/8 dr (1 pack required per lock) | \$45.01 |
| 10-3428 | Tailpiece Pack, SF-Option | \$9.38 |
| 13-0896 | Cylinder tailpiece - 10 Line 50 function only | \$1.85 |
| 14-0057 | Emergency Release Key (65 function only) | \$1.68 |
| 14-0299 | Lockout Key (10G50 function-for inside button) | \$4.95 |
| *C10-3 | Emergency Release Cylinder (65 function) | \$52.96 |

* Order by Finish 3, 4, 9, 10,10B, 15, 26, 26D

Note: See page BL-23 for replacement kits for 7600 Integra Locks. Must specify if intending to use with 10-Line lockset.

BL-28 BORED LOCKS

SARGENT®



7-LINE OPTIONS

ASSA ABLOY

USA & Canada Prices Effective June 3, 2019

| Options | Description | Price |
|---------|--|----------------|
| 1- | 7 Line Lock for 1-3/8" door (Shim Kits) | No addition |
| 10 | SARGENT Signature Key System | \$58.00 / cyl. |
| 11 | SARGENT XC Key System (not available with 10, 22, SC, SE options) | No addition |
| 1160 | Sargent XC Large Format Interchangeable Plastic Disposable Construction Core | No addition |
| 1163 | Sargent XC Large Format Interchangeable Core Cylinder - Includes masterkeying charges | \$77.00 |
| 1164 | Sargent XC Large Format Interchangeable Construction Core Cylinder | \$77.00 |
| 1170 | Small Format interchangeable disposable construction core - to accept 7 Pin XC permanent core | No addition |
| 11727P | Small Format interchangeable keyed construction core - to accept 7 Pin XC permanent core | 69 |
| 11737P | Small Format interchangeable core - to accept 7 pin XC permanent core | \$69.00 |
| 14 | 505 Full Lip Strike | No addition |
| 20 | 2-3/8" Backset Latch w/shim kits to fit 1-3/8" door | No addition |
| 21 | SARGENT Construction Key System (lost ball) Standard on all new systems est. since 5/1/96 | \$16.00 / cyl. |
| 22 | SARGENT Construction Key System (split key) To be used on pre-est. split key systems only | \$32.00 / cyl. |
| 28 | Lockset x ANSI A-156.115 Strike – 1-1/4" Lip Standard | |
| | Lip Lengths 1-1/8" or 1-3/8" | No addition |
| | Lip Lengths 1-5/8", 1-7/8", 2-1/8", 2-3/8", 2-5/8", 2-7/8" | \$11.00 |
| 30 | 7 Line Lever to accept Schlage cylinder - no cylinder provided | No addition |
| 36 | 6 Lobe Security Head Screws | \$14.00 |
| 37 | Spanner Head Screws | \$9.00 |
| 60 | SARGENT Large Format Interchangeable Plastic Disposable Construction Core | No addition |
| 63 | SARGENT Large Format Interchangeable Core Cylinder | |
| | includes master and grandmaster keying charge | \$77.00 / cyl. |
| 64 | SARGENT Large Format Interchangeable Construction Core Cylinder | \$77.00 |
| 6573 | Small Format 6-Pin Uncombined Cores | \$59.00 / cyl. |
| 65737P | Small Format 7-Pin Uncombined Cores | \$59.00 / cyl. |
| 70 | Small Format Interchangeable disposable plastic construction core | No addition |
| 72 | Small Format Interchangeable 6 Pin Construction core (7-Pin w/11- option) | \$66.00 |
| 73 | Small Format Interchangeable Core, 6-Pin | |
| | Includes MK and GMK keying charges | \$69.00 / cyl. |
| 737P | Small Format Interchangeable Core, 7-Pin | |
| | Includes MK and GMK keying charges | \$69.00 / cyl. |
| 74 | Lead Lining I/S Rose, O/S Rose, and Latch Tube | \$198.00 |
| 75 | Tactile Warning - Milled on backside of inside lever | \$37.00 |
| 76 | Tactile Warning - Milled on backside of outside lever | \$37.00 |
| 77 | Tactile Warning - Milled on backside of both levers | \$74.00 |
| 80 | Levers to accept KESO and Keso F1 cylinders – no cylinders provided | -\$87.00/cyl. |
| F182 | SARGENT KESO Security Cylinder – patented – new key systems | \$84.00 /cyl. |
| 82 | SARGENT KESO Security Cylinder – existing key systems ONLY | \$84.00 /cyl. |
| 85 | Tactile Warning - Abrasive coating on inside lever | \$45.00 |
| 86 | Tactile Warning - Abrasive coating on outside lever | \$45.00 |
| 87 | Tactile Warning - Abrasive coating on both levers | \$90.00 |
| BR | SARGENT Bump Resistant Cyls. (N/A w/10, 22, 30, 60, 63, 64, 70, 72, 73, 737P, KESO, SC, SE) | \$23.00 /cyl. |
| DG1 | Patented Degree DG1 Key System | No Addition |
| DG160 | Hardware prepared for DG1-6300 Lg. Format IC cores, supplied with temporary plastic construction cores | No addition |
| DG163 | Patented Degree DG1 Large Format Interchangeable Core Cylinder - Includes master keying charges | \$77.00 |
| DG164 | Hardware prepared for DG1-6300 Lg. Format IC cores, supplied with temporary keyed construction cores | \$77.00 |
| DG2 | Patented Degree DG2 Key System incorporating a locking sidebar | \$58.00/cyl. |
| DG260 | Hardware prepared for DG2-6300 Lg. Format IC cores, supplied with temporary plastic construction cores | No addition |
| DG263 | Patented Degree DG2 Large Format Interchangeable Core Cylinder - Includes master keying charges | \$135.00 |
| DG264 | Hardware prepared for DG2-6300 Lg. Format IC cores, supplied with temporary keyed construction cores | \$77.00 |
| DG3 | Patented Degree DG3 Key System incorporating a locking sidebar and UL437 listed | \$82.00/cyl. |
| DG360 | Hardware prepared for DG3-6300 Lg. Format IC cores, supplied with temporary plastic construction cores | No addition |
| DG363 | Patented Degree DG3 Large Format Interchangeable Core Cylinder - Includes master keying charges | \$159.00 |
| DG364 | Hardware prepared for DG3-6300 Lg. Format IC cores, supplied with temporary keyed construction cores | \$77.00 |
| FW | Freewheeling Locking Levers – 04, 05, 37, 65 Functions | \$8.00 |
| LC | Less Cylinder | -\$87.00/cyl. |
| SC | Schlage C Keyway Cylinder, 0-bitted | No addition |
| SE | Schlage E Keyway Cylinder, 0-bitted | No addition |
| SF | L Lever to accept Schlage Large Format Interchangeable Core (supplied less core, tailpiece included) | No addition |
| SG | MicroShield® – an antimicrobial powder coat | |
| \$67.00 | | |
| WBS | Wrought Box Strike | No Addition |
| CPC | Clear Powder Coat over 26D – 7G05 x LL x 26D x CPC All orders will continue to be handled as a "special" when CPC is ordered. | \$62.00 |

USA & Canada Prices Effective June 3, 2019

| Rose Design: | | Lever Design: | |  |  |  |
|------------------|---|---------------|--|---|--|---|
| L – Rose | | L – Lever | | LL | LB | LP |
| | | B – Lever | | | | |
| | | P – Lever | | | | |
| | | | | “L” Rose with “L” Lever | “L” Rose with “B” Lever | “L” Rose with “P” Lever |
| Function | | | | Finish | | |
| Cylinder | | | | 10BE/26D BSP/WSP | 03/04/09/10/10B, 10BL/14/15/20D/26 | |
| 7G04 | Storeroom/Closet | | | | | |
| 7G05 | Entrance/Office | | | \$286.00 | \$302.00 | |
| 7G37 | Classroom | | | | | |
| Non Keyed | | | | | | |
| 7U15 | Passage | | | \$207.00 | \$223.00 | |
| 7G15-3 | Communicating | | | | | |
| 7U65 | Privacy | | | \$228.00 | \$244.00 | |
| 7U68 | Hospital/Privacy | | | | | |
| 7U93 | Single Lever Pull | | | \$116.00 | \$124.00 | |
| 7U94 | Double lever pull | | | | | |
| 7U94-2 | Double lever pull x Latchbolt Plate | | | \$219.00 | \$235.00 | |
| Strikes | | | | | | Specify Finish |
| 505 | Full Lip Strike (not available in longer lip lengths) | | | | | \$16.30 |
| 800 | ANSI A115.2 T Strike (Standard) | | | | | |
| | Lip Lengths available: 1”, 1-1/4” (Standard), 1-1/2”, 1-3/4”, 2” | | | | | Refer to page BL-47 |
| 808 | ANSI A115.2 – 4-7/8” Strike (Option 28-) | | | | | |
| | Lip Lengths available: 1-1/8”, 1-1/4” (Standard), 1-3/8”, 1-5/8”, 1-7/8”, 2-1/8”, 2-3/8”, 2-5/8”, 2-7/8” | | | | | Refer to page BL-47 |
| AM-0044 | Strike Box (Standard) | | | | | \$10.80 |
| 77-1141 | Strike Box (Option 28-) | | | | | \$10.80 |

NOTE: Split finishes are available, price as higher finish. Order outside/inside and handing must be specified. Strike and latch front will match inside finish for RH/LH and outside finish for RHR/LHR.

7-LINE COASTAL SERIES OPTIONS



USA & Canada Prices Effective June 3, 2019

| Options | Description | Price |
|---------|---|------------------------|
| 1- | 7 Line Lock for 1-3/8" door (Shim Kits) | No addition |
| 10 | SARGENT Signature Key System | \$58.00 / cyl. |
| 11 | SARGENT XC Key System (not available w/10, 22, 30, 60, 63, 64, SC, SE, VA, VS options) | No addition |
| 1160 | Sargent XC Large Format Interchangeable Plastic Disposable Construction Core | No addition |
| 1163 | Sargent XC Large Format Interchangeable Core Cylinder - Includes masterkeying charges | \$77.00 |
| 1164 | Sargent XC Large Format Interchangeable Construction Core Cylinder | \$77.00 |
| 1170 | Small Format interchangeable disposable construction core - to accept 7 Pin XC permanent core | No addition |
| 11727P | Small Format interchangeable keyed construction core - to accept 7 Pin XC permanent core | 69 |
| 11737P | Small Format interchangeable core - to accept 7 pin XC permanent core | \$69.00 |
| 14 | 505 Full Lip Strike | No addition |
| 20 | 2-3/8" Backset Latch w/shim kits to fit 1-3/8" door | No addition |
| 21 | SARGENT Construction Key System (lost ball) Standard on all new systems est. since 5/1/96 | \$16.00 / cyl. |
| 22 | SARGENT Construction Key System (split key) To be used on pre-est. split key systems only | \$32.00 / cyl. |
| 28 | Lockset x ANSI A-156.115 Strike – 1-1/4" Lip Standard Lip Lengths 1-1/8" or 1-3/8" Lip Lengths 1-5/8", 1-7/8", 2-1/8", 2-3/8", 2-5/8", 2-7/8" | No addition \$11.00 |
| 30 | 7 Line Lever to accept Schlage cylinder - no cylinder provided | No addition |
| 36 | 6 Lobe Security Head Screws | \$14.00 |
| 37 | Spanner Head Screws | \$9.00 |
| 60 | SARGENT Large Format Interchangeable Plastic Disposable Construction Core | No addition |
| 63 | SARGENT Large Format Interchangeable Core Cylinder includes master and grandmaster keying charge | \$77.00 / cyl. |
| 64 | SARGENT Large Format Interchangeable Construction Core Cylinder | \$77.00 |
| 6573 | Small Format 6-Pin Uncombined Cores | \$59.00 / cyl. |
| 65737P | Small Format 7-Pin Uncombined Cores | \$59.00 / cyl. |
| 70 | Small Format Interchangeable disposable plastic construction core | No addition |
| 72 | Small Format Interchangeable 6 Pin Construction core (7-Pin w/11- option) | \$66.00 |
| 73 | Small Format Interchangeable Core, 6-Pin Includes MK and GMK keying charges | \$69.00 / cyl. |
| 737P | Small Format Interchangeable Core, 7-Pin Includes MK and GMK keying charges | \$69.00 / cyl. |
| 74 | Lead Lining I/S Rose, O/S Rose, and Latch Tube | \$198.00 |
| 80 | Levers to accept KESO and Keso F1 cylinders – no cylinders provided | -\$87.00/cyl. |
| F182 | SARGENT KESO Security Cylinder – patented – new key systems | \$84.00 /cyl. |
| 82 | SARGENT KESO Security Cylinder – existing key systems ONLY | \$84.00 /cyl. |
| 85 | Tactile Warning - Abrasive coating on inside lever | \$45.00 |
| 86 | Tactile Warning - Abrasive coating on outside lever | \$45.00 |
| 87 | Tactile Warning - Abrasive coating on both levers | \$90.00 |
| BR | SARGENT Bump Resistant Cyls. (N/A w/10, 22, 30, 60, 63, 64, 70, 72, 73, 737P, KESO, SC, SE) | \$23.00 /cyl. |
| DG1 | Patented Degree DG1 Key System | No Addition |
| DG160 | Hardware prepared for DG1-6300 Lg. Format IC cores, supplied with temporary plastic construction cores | No addition |
| DG163 | Patented Degree DG1 Large Format Interchangeable Core Cylinder - Includes master keying charges | \$77.00 |
| DG164 | Hardware prepared for DG1-6300 Lg. Format IC cores, supplied with temporary keyed construction cores | \$77.00 |
| DG2 | Patented Degree DG2 Key System incorporating a locking sidebar | \$58.00/cyl. |
| DG260 | Hardware prepared for DG2-6300 Lg. Format IC cores, supplied with temporary plastic construction cores | No addition |
| DG263 | Patented Degree DG2 Large Format Interchangeable Core Cylinder - Includes master keying charges | \$135.00 |
| DG264 | Hardware prepared for DG2-6300 Lg. Format IC cores, supplied with temporary keyed construction cores | \$77.00 |
| DG3 | Patented Degree DG3 Key System incorporating a locking sidebar and UL437 listed | \$82.00/cyl. |
| DG360 | Hardware prepared for DG3-6300 Lg. Format IC cores, supplied with temporary plastic construction cores | No addition |
| DG363 | Patented Degree DG3 Large Format Interchangeable Core Cylinder - Includes master keying charges | \$159.00 |
| DG364 | Hardware prepared for DG3-6300 Lg. Format IC cores, supplied with temporary keyed construction cores | \$77.00 |
| FW | Freewheeling Locking Levers – 04, 05, 37, 65 Functions | \$8.00 |
| LC | Less Cylinder | -\$87.00/cyl. |
| SC | Schlage C Keyway Cylinder, 0-bitted | No addition |
| SE | Schlage E Keyway Cylinder, 0-bitted | No addition |
| SG | MicroShield® – an antimicrobial powder coat | \$67.00 |
| WBS | Wrought Box Strike | No Addition |

CPC Clear Powder Coat over 26D – 7G05 x LY x 26D x CPC \$62.00
All orders will continue to be handled as a "special" when CPC is ordered.

7-LINE COASTAL SERIES

USA & Canada Prices Effective June 3, 2019

| Rose Design: L – Rose | Lever Design: *Y – Lever *G – Lever |  |  |
|--|---|---|---|
| *Handed – specify hand when ordering | | LY “L” Rose with “Y” Lever | LG “L” Rose with “G” Lever |
| Function Cylinder | | Finish | |
| | | 10BE/26D BSP/WSP | 03/04/09/10/10B/ 10BL/14/15/20D/26 |
| 7G04 | Storeroom/Closet | | |
| 7G05 | Entry/Office | \$304.00 | \$320.00 |
| 7G37 | Classroom | | |
| Non Keyed | | | |
| 7U15 | Passage | \$225.00 | \$241.00 |
| 7G15-3 | Communicating | | |
| 7U65 | Privacy | \$246.00 | \$262.00 |
| 7U68 | Hospital/Privacy | | |
| 7U93 | Single Lever Pull | \$134.00 | \$142.00 |
| 7U94 | Double lever pull | | |
| 7U94-2 | Double lever pull x Latchbolt Plate | \$237.00 | \$253.00 |
| Strikes - See catalog for available lip lengths | | Specify Finish | |
| 505 | Full Lip strike (not available in longer lip lengths) | | \$16.30 |
| 800 | ANSI A115.2 T Strike (Standard) Lip Lengths available: 1", 1-1/4" (Standard), 1-1/2", 1-3/4", 2" | | Refer to page BL-47 |
| 808 | ANSI A115.2 – 4-7/8" Strike (Option 28-) Lip Lengths available: 1-1/8", 1-1/4" (Standard), 1-3/8", 1-5/8", 1-7/8", 2-1/8", 2-3/8", 2-5/8", 2-7/8" | | Refer to page BL-47 |
| AM-0044 | Strike Box (Standard) | | \$10.80 |
| 77-1141 | Strike Box (Option 28-) | | \$10.80 |

NOTE: Split finishes are available, price as higher finish. Order outside/inside and handing must be specified. Strike and latch front will match inside finish for RH/LH and outside finish for RHR/LHR.

BL-32 BORED LOCKS

7-LINE LEVERS

SARGENT®

ASSA ABLOY

USA & Canada Prices Effective June 3, 2019

| Lever Handles | | Finish |
|---|--|---|
| Part # | Description (Inside or Outside) | 03/04/09/10/10B/10BE/10BL/14/15/20D/26/26D/BSP/WSP |
| 10-0501 | "L" design, Passage | |
| 10-0502 | "L" design, Cylinder, Emergency Release (65) | |
| 10-0503 | "L" design, Turn Button and 30- option | |
| 10-0504 | "L" design, prepared for SARGENT Removable core cylinder | |
| 10-0505 | "L" design, prepared for Interchangeable core cylinder 72- | |
| 10-0506 | "L" design, prepared for SARGENT Keso (82) cylinder | |
| 10-0545 | "P" design, Passage | |
| 10-0546 | "P" design, Cylinder, Emergency Release (65) | |
| 10-0547 | "P" design, Turn Button and 30- option | |
| 10-0548 | "P" design, prepared for SARGENT Removable core cylinder | \$71.00 |
| 10-0549 | "P" design, prepared for Interchangeable core cylinder 72- | |
| 10-0550 | "P" design, prepared for SARGENT Keso (82) cylinder | |
| 10-0523 | "B" design, Passage | |
| 10-0524 | "B" design, Cylinder, Emergency Release (65) | |
| 10-0525 | "B" design, Turn Button and 30- option | |
| 10-0526 | "B" design, prepared for SARGENT Removable core cylinder | |
| 10-0527 | "B" design, prepared for Interchangeable core cylinder 72- | |
| 10-0528 | "B" design, prepared for SARGENT Keso (82) cylinder | |
| Lever Handles w/Handicap Warning | | Finish |
| Part # | Description (Inside or Outside) | 03/04/09/10/10B/10BE/10BL/14/15/20D/26/26D/BSP/WSP |
| 10-0512 | "L" design, Passage | |
| 10-0513 | "L" design, Cylinder, Emergency Release (65) | |
| 10-0514 | "L" design, Turn Button, T-Turn and 30- option | |
| 10-0515 | "L" design, prepared for SARGENT Removable core cylinder | |
| 10-0516 | "L" design, prepared for SARGENT Interchangeable 72- core cylinder | |
| 10-0556 | "P" design, Passage | |
| 10-0557 | "P" design, Cylinder, Emergency Release (65) | |
| 10-0558 | "P" design, Turn Button, T-Turn and 30- option | \$109.00 |
| 10-0559 | "P" design, prepared for SARGENT Removable core cylinder | |
| 10-0560 | "P" design, prepared for SARGENT Interchangeable 72- core cylinder | |
| 10-0534 | "B" design, Passage | |
| 10-0535 | "B" design, Cylinder, Emergency Release (65) | |
| 10-0536 | "B" design, Turn Button, T-Turn and 30- option | |
| 10-0537 | "B" design, prepared for SARGENT Removable core cylinder | |
| 10-0538 | "B" design, prepared for SARGENT Interchangeable 72- core cylinder | |

| Lever Handles - Coastal Series Design | | Finish |
|---------------------------------------|--|--|
| Part # | Description (Inside or Outside) | 03/04/09/10/10B/10BE/10BL/14/15/20D/26/26D/BSP/WSP |
| 10-0611 | "Y" design, Passage - Left | |
| 10-0612 | "Y" design, Passage - Right | |
| 10-0613 | "Y" design, Cylinder and emergency release (65) - Left | |
| 10-0614 | "Y" design, Cylinder and emergency release (65) - Right | |
| 10-0615 | "Y" design, Turn Button, T-Turn and 30- option - Left | |
| 10-0616 | "Y" design, Turn Button, T-Turn and 30- option - Right | |
| 10-0617 | "Y" design, prepared for SARGENT Removable core cylinder - Left | |
| 10-0618 | "Y" design, prepared for SARGENT Removable core cylinder - Right | |
| 10-0619 | "Y" design, prepared for SARGENT Interchangeable 72- core cylinder - Left | |
| 10-0620 | "Y" design, prepared for SARGENT Interchangeable 72- core cylinder - Right | |
| 10-0621 | "Y" design, prepared for SARGENT Keso (82) cylinder - Left | |
| 10-0622 | "Y" design, prepared for SARGENT Keso (82) cylinder - Right | |
| 10-0567 | "G" design, Passage - Left | \$71.00 |
| 10-0568 | "G" design, Passage - Right | |
| 10-0569 | "G" design, Cylinder and emergency release (65) - Left | |
| 10-0570 | "G" design, Cylinder and emergency release (65) - Right | |
| 10-0571 | "G" design, Turn Button, T-Turn and 30- option - Left | |
| 10-0572 | "G" design, Turn Button, T-Turn and 30- option - Right | |
| 10-0573 | "G" design, prepared for SARGENT Removable core cylinder - Left | |
| 10-0574 | "G" design, prepared for SARGENT Removable core cylinder - Right | |
| 10-0575 | "G" design, prepared for SARGENT Interchangeable 72- core cylinder - Left | |
| 10-0576 | "G" design, prepared for SARGENT Interchangeable 72- core cylinder - Right | |
| 10-0577 | "G" design, prepared for SARGENT Keso (82) cylinder - Left | |
| 10-0578 | "G" design, prepared for SARGENT Keso (82) cylinder - Right | |

BL-34 BORED LOCKS

SARGENT®

7-LINE ASSEMBLIES

ASSA ABLOY

USA & Canada Prices Effective June 3, 2019

| <u>Lock Body Assemblies Standard Cylinder and non cylinder Functions</u> | | |
|--|---|----------|
| Part # | Function | Price |
| 07-2650 | 04 | |
| * 07-2660 | 05 | |
| 07-2670 | 15 | |
| 07-2675 | 15-3 | \$138.42 |
| 07-2680 | 37 | |
| * 07-2690 | 65, 68 – order emergency release separately | |
| <u>Lock Body Assemblies To Accept SARGENT Removable Core Cylinders (60-, 63-, 64-Options)</u> | | |
| Part # | Function | Price |
| 07-2651 | 04 | |
| * 07-2661 | 05 | \$154.14 |
| 07-2681 | 37 | |
| <u>Lock Body Assemblies To Accept Arrow, Best, Falcon Interchangeable Cores</u> | | |
| Part # | Function | Price |
| 07-2652 | 04 | |
| * 07-2662 | 05 | \$169.82 |
| 07-2682 | 37 | |
| <u>Lock Body Assemblies To Accept SARENT Keso (82-) Cylinders</u> | | |
| Part # | Function | Price |
| 07-2653 | 04 | |
| * 07-2663 | 05 | \$153.38 |
| 07-2683 | 37 | |
| <u>FW-Lock Body Assemblies Standard Cylinder and non cylinder Functions</u> | | |
| Part # | Function | Price |
| 07-2654 | 04 | |
| * 07-2664 | 05 | |
| 07-2684 | 37 | \$149.87 |
| * 07-2691 | 65, 68 | |
| <u>FW-Lock Body Assemblies To Accept SARENT Removable Core Cylinders (60-, 63-, 64- Options)</u> | | |
| Part # | Function | Price |
| 07-2655 | 04 | |
| * 07-2665 | 05 | \$163.39 |
| 07-2685 | 37 | |
| <u>FW-Lock Body Assemblies To Accept SARENT Interchangeable Core Cylinders (70-, 72-, 73- Options)</u> | | |
| Part # | Function | Price |
| 07-2656 | 04 | |
| * 07-2666 | 05 | \$179.57 |
| 07-2686 | 37 | |
| <u>FW-Lock Body Assemblies To Accept SARENT Keso (82-) Cylinders</u> | | |
| Part # | Function | Price |
| 07-2657 | 04 | |
| * 07-2667 | 05 | \$163.39 |
| 07-2687 | 37 | |

7-LINE ROSES/LATCHES/PARTS

USA & Canada Prices Effective June 3, 2019

| Roses | | 10BE/26D BSP/WSP | 03/04/09/10/10B/ 10BL/14/15/20D/26 |
|---------------------------------|--|--|---|
| 07-0111 | Rose Scalp (all) | \$34.25 | \$42.82 |
| 07-2428 | Outside Rose Spring Assy. (15-3) | \$39.97 | \$49.95 |
| Latch Units | | 03/10/10B/ 10BE/32D/BSP/WSP | |
| Standard 2-3/4" Backset | | | |
| 07-2430 | Deadlocking Latch | | \$31.62 |
| 07-2432 | Latch | | |
| 20 Option 2-3/8" Backset | | | |
| 07-2431 | Deadlocking Latch | | \$31.62 |
| 07-2433 | Latch | | |
| Miscellaneous Parts | | | |
| Part # | Description | Price | |
| 01-0949 | Washer only – for Schlage cylinder (30 option) (2 required per lock) | \$0.81 | |
| 01-4414 | Screw Pan Head (#6-3/4"), (2 per lock) – surface screws | \$0.32 | |
| 07-0100 | Spacer - Cardboard | \$0.67 | |
| 07-0102 | I/S Support Plate (1-3/4" door) | \$6.09 | |
| 07-0105 | O/S Support Plate (1-3/4" door) | \$6.09 | |
| 07-0112 | Inside Rose Spring Assy. (94, 94-2) | \$29.91 | |
| 07-0113 | Outside Rose Spring Assy. (93, 94, 94-2) | \$31.40 | |
| 07-2425 | Inside Rose Spring Assy. (all except 94, 94-2) | \$45.67 | |
| 07-2426 | Outside Rose Spring Assy. (all except 93, 94, 94-2, 15-3) | \$45.67 | |
| 07-2648 | 1-3/8" Door Mounting Kit (1 plate & 2 spacers) (1 & 20 option) | \$9.58 | |
| 07-2446 | Thru-Bolt Mounting Pack (standard screw pack - hollow & long screw) | \$7.64 | |
| * 07-2447 | Dummy Thru-Bolt Mounting Pack (US3 or26D finish only) | \$4.55 | |
| * 08-2842 | Blank Front Assembly - 94-2 function | \$19.36 | |
| 10-0019 | Cylinder Spacer - white plastic disk | \$0.64 | |
| 10-0032 | Cylinder Retainer (Standard except IC, RC & KESO Cores) | \$1.56 | |
| 10-0043 | Push pin tool | \$0.54 | |
| 10-0077 | Lever catch spring | \$1.56 | |
| 10-0197 | Lever Retainer | \$0.72 | |
| 10-0239 | 6-pin tailpiece (removable & interchangeable core) | \$1.85 | |
| 10-0240 | 7-pin tailpiece (interchangeable core) | \$1.79 | |
| * 10-2052 | Standard Screw Pack - all functions (for strike & front and surface screws) | \$4.69 | |
| * 10-2070 | Screwpack (28- option) - all functions (for strike & front and surface screws) | \$1.88 | |
| 10-2071 | Screw pack (dummy trim 94 & 94-2 function) | \$1.56 | |
| 10-2090 | Cylinder retainer & washer pack (30 option) | \$8.61 | |
| 10-3138 | Cylinder tailpiece for 11- IC Core | \$6.18 | |

*Specify finish when ordering.

BL-36 BORED LOCKS

SARGENT®

6500



KL shown

Rose Design:
K (Shown)

Lever Design:
B
L
P

ASSA ABLOY

Price Book No. 33

USA & Canada Prices Effective June 3, 2019

Expect Longer Lead times (Approx 8 weeks): split finishes,
65G15-3, KB & KP trims.

| Options | Description | Price |
|---------|--|----------------|
| 10 | SARGENT Signature Key System | \$58.00 / cyl. |
| 11 | SARGENT XC Key System (not available with 10, 22, SC, SE options) | No addition |
| 1160 | Sargent XC Large Format Interchangeable Plastic Disposable Construction Core | No addition |
| 1163 | Sargent XC Large Format Interchangeable Core Cylinder - Includes masterkeying charges | \$77.00 |
| 1164 | Sargent XC Large Format Interchangeable Construction Core Cylinder | \$77.00 |
| 1170 | Small Format interchangeable disposable construction core - to accept 7 Pin XC permanent core | No addition |
| 11727P | Small Format interchangeable keyed construction core - to accept 7 Pin XC permanent core | \$69.00 |
| 11737P | Small Format interchangeable core - to accept 7 pin XC permanent core | \$69.00 /cyl. |
| 14 | 505 Full Lip Strike | No addition |
| 20 | 2-3/8" Backset Latch – Fits 1-3/8" Door | No addition |
| 21 | SARGENT Construction Key System (lost ball) Standard on all new systems est. since 5/1/96 | \$16.00 / cyl. |
| 22 | SARGENT Construction Key System (split key) To be used on pre-est. split key systems only | \$32.00 / cyl. |
| 28 | Lockset x ANSI A115.2 Strike #808 – 1-1/4" standard lip Lip Lengths 1-1/8" , or 1-3/8" | No addition |
| | Lip Lengths 1-5/8", 1-7/8", 2-1/8", 2-3/8", 2-5/8", 2-7/8" | \$11.00 |
| 60 | SARGENT Large Format Interchangeable Plastic Disposable Construction Core | No addition |
| 63 | SARGENT Large Format Interchangeable Core Cylinder includes master and grandmaster keying charge | \$77.00 / cyl. |
| 64 | SARGENT Large Format Interchangeable Construction Core Cylinder | \$77.00 |
| 6573 | Small Format 6 Pin Uncombined Interchangeable Core | \$59.00 / cyl. |
| 65737P | Small Format 7 Pin Uncombined Interchangeable Core | \$59.00 / cyl. |
| 70 | Small Format Interchangeable disposable plastic construction core | No addition |
| 72 | Small Format Interchangeable 6 Pin Construction Core (7-Pin w/11- option) | See page CK-2 |
| 73 | Small Format Interchangeable Core, 6-Pin Includes MK and GMK keying charges | \$69.00 / cyl. |
| 737P | Small Format Interchangeable Core, 7-Pin Includes MK and GMK keying charges | \$69.00 / cyl. |
| 85 | Tactile Warning - Abrasive coating on inside lever | \$45.00 |
| 86 | Tactile Warning - Abrasive coating on outside lever | \$45.00 |
| 87 | Tactile Warning - Abrasive coating on both levers | \$90.00 |
| BR | SARGENT Bump Resistant Cyls. (N/A w/10, 22, 30, 60, 63, 64, 70, 72, 73, 737P, KESO, SC, SE) | \$23.00 /cyl. |
| DG1 | Patented Degree DG1 Key System | No Addition |
| DG160 | Hardware prepared for DG1-6300 Lg. Format IC cores, supplied with temporary plastic construction cores | No addition |
| DG163 | Patented Degree DG1 Large Format Interchangeable Core Cylinder - Includes master keying charges | \$77.00 |
| DG164 | Hardware prepared for DG1-6300 Lg. Format IC cores, supplied with temporary keyed construction cores | \$77.00 |
| DG2 | Patented Degree DG2 Key System incorporating a locking sidebar | \$58.00/cyl. |
| DG260 | Hardware prepared for DG2-6300 Lg. Format IC cores, supplied with temporary plastic construction cores | No addition |
| DG263 | Patented Degree DG2 Large Format Interchangeable Core Cylinder - Includes master keying charges | \$135.00 |
| DG264 | Hardware prepared for DG2-6300 Lg. Format IC cores, supplied with temporary keyed construction cores | \$77.00 |
| DG3 | Patented Degree DG3 Key System incorporating a locking sidebar and UL437 listed | \$82.00/cyl. |
| DG360 | Hardware prepared for DG3-6300 Lg. Format IC cores, supplied with temporary plastic construction cores | No addition |
| DG363 | Patented Degree DG3 Large Format Interchangeable Core Cylinder - Includes master keying charges | \$159.00 |
| DG364 | Hardware prepared for DG3-6300 Lg. Format IC cores, supplied with temporary keyed construction cores | \$77.00 |
| LC | Less Cylinder | -\$87.00/cyl. |
| SC | Schlage C keyway cylinder, O-bitted | No addition |
| SE | Schlage E keyway cylinder, O-bitted | No addition |

| Function Cylinder | | Finish 10BE/26D | Finish 03/04/10/10B/26 |
|-------------------|-----------|-----------------|------------------------|
| 65G04 | Storeroom | | |
| 65G05 | Office | \$284.00 | \$286.00 |
| 65G37 | Classroom | | |

| Non Keyed | | | |
|-----------|----------------------------|----------|----------|
| 65U15 | Passage | \$197.00 | \$199.00 |
| 65G15-3 | Exit or Twin Communicating | \$224.00 | \$226.00 |
| 65U65 | Privacy | \$224.00 | \$226.00 |
| 65U93 | Single Lever Pull | \$90.00 | \$91.00 |
| 65U94 | Double Lever Pull | \$175.00 | \$177.00 |

NOTE: Split finishes are available, price as higher finish. Order outside/inside and handing must be specified. Strike and latch front will match inside finish for RH/LH and outside finish for RHR/LHR.

| Latchbolts | | | 10B/10BE/32/32D |
|------------|-----------|----------------------------|-----------------|
| 05-2182 | Guarded | (Standard 2-3/4" Backset) | \$37.19 |
| 05-2183 | Unguarded | (Standard 2-3/4" Backset) | \$32.21 |
| 05-2184 | Guarded | (20 Option 2-3/8" Backset) | \$36.12 |
| 05-2185 | Unguarded | (20 Option 2-3/8" Backset) | \$32.21 |

| Strikes | | Specify Finish |
|---------|--|---------------------|
| 808 | ANSI A115.2 – 4-7/8" Strike (Option 28-)Lip Lengths available: 1-1/8", 1-1/4" (Standard), 1-3/8", 1-5/8", 1-7/8", 2-1/8", 2-3/8", 2-5/8", 2-7/8" | Refer to page BL-47 |
| 505 | Full Lip Strike | \$16.30 |
| 77-1141 | Strike Box – for 808 Strike | \$10.80 |
| 05-3124 | Cylinder tailpiece for 11- IC core | \$9.53 |

USA & Canada Prices Effective June 3, 2019



TOL

Rose: TO, CO, O, E2
TR•, CR•, LN•, E3•
Lever: A*, B, E, F, J, L, P, W

How to order: 28-DLU65 x TOL x 26D
Option: 28
Function: DLU65
Rose: TO
Lever: L
Finish: 26D

***Specify hand when ordering**

•Roses available with DLU93 & DLU94 functions only

| Options | Description | Price |
|---------|--|-------------|
| 12 | 3 Hour UL Latch | Add \$6.00 |
| 13 | Lockset x Front & Strike with 1/4" Radius and 2-3/8" Backset | No addition |
| 14 | 505 Full Lip Strike | No addition |
| 20 | 2-3/8" backset latch with 1" front | No addition |
| 28 | Lockset x ANSI A-156.115 Strike – 1-1/4" Lip Standard | No addition |
| | Lip Lengths 1-1/8" or 1-3/8" | No addition |
| | Lip Lengths 1-5/8", 1-7/8", 2-1/8", 2-3/8", 2-5/8", 2-7/8" | \$14.00 |
| 31 | 1-7/8" to 2" thick door – only centered in door | No addition |
| SG | MicroShield® an antimicrobial powder coat | \$67.00 |
| TB | Through-bolting (for DLU93 function only) | Add \$29.00 |
| WBS | Wrought Box Strike | No Addition |

| Non-Keyed Functions | | 10BE/26D BSP/WSP | 03/04/09/10/10B/10BL/ 14/15/20D/26/32/32D |
|---------------------|----------------------------|---------------------|--|
| DLU15 | Passage | \$228.00 | \$238.00 |
| DLU15-3 | Exit or Twin Communicating | \$228.00 | \$238.00 |
| DLU65 | Privacy | \$243.00 | \$253.00 |
| * DLU93 | Single Lever Pull | \$100.00 | \$105.00 |
| ** DLU94 | Double Lever Pull | \$190.00 | \$200.00 |

* DLU93 is only available with TB option

** DLU94 is not available with any above options

| Latchbolts | Description | 10BE/26D/BSP/WSP |
|------------|--------------------------------------|------------------|
| DL-2000 | Latch - 2 3/8" backset (15 function) | \$30.57 |
| DL-2001 | Latch - 2 3/4" backset (15 function) | \$30.57 |
| DL-2002 | Latch - 2 3/8" backset (65 function) | \$30.57 |
| DL-2003 | Latch - 2 3/4" backset (65 function) | \$30.57 |

| Part# | Description | Price |
|---------|-------------|--------|
| 82-1038 | Set Screw | \$1.88 |

BL-38 BORED LOCKS

SARGENT®

DL COASTAL SERIES

ASSA ABLOY

USA & Canada Prices Effective June 3, 2019



TOY

Rose: TO, CO, O, E2
TR•, CR•, LN•, E3•
Lever: G*, R, S*, Y*

How to order: 28-DLU65 x TOC x 26D
Option: 28
Function: DLU65
Rose: TO
Lever: C
Finish: 26D

***Specify hand when ordering**

•Roses available with DLU93 & DLU94 functions only

| Options | Description | Price |
|---------|--|-------------|
| 12 | 3 Hour UL Latch | \$6.00 |
| 13 | Lockset x Front & Strike with 1/4" Radius and 2-3/8" Backset | No Addition |
| 14 | 505 Full Lip Strike | No addition |
| 20 | 2-3/8" backset latch with 1" front | No addition |
| 28 | Lockset x ANSI A-156.115 Strike – 1-1/4" Lip Standard | No addition |
| | Lip Lengths 1-1/8" or 1-3/8" | No addition |
| | Lip Lengths 1-5/8", 1-7/8", 2-1/8", 2-3/8", 2-5/8", 2-7/8" | \$14.00 |
| 31 | 1-7/8" to 2" thick door – only centered in door | No addition |
| SG | MicroShield® an antimicrobial powder coat | \$67.00 |
| TB | Through-bolting (for DLU93 function only) | \$29.00 |
| WBS | Wrought Box Strike | No Addition |

| Non-Keyed Functions | | 10BE/26D BSP/WSP | 03/04/09/10/10B/ 10BL/14/15/20D/26 |
|---------------------|----------------------------|---------------------|---------------------------------------|
| DLU15 | Passage | \$228.00 | \$238.00 |
| DLU15-3 | Exit or Twin Communicating | \$228.00 | \$238.00 |
| DLU65 | Privacy | \$243.00 | \$253.00 |
| * DLU93 | Single Lever Pull | \$100.00 | \$105.00 |
| ** DLU94 | Double Lever Pull | \$190.00 | \$200.00 |

* DLU93 is only available with TB option

** DLU94 is not available with any above options

USA & Canada Prices Effective June 3, 2019



TOMC



COMN



OMH

Rose: TO, CO, O, E2
TR, CR, LN, E3 – available with DLU93 & DLU94 functions only.

How to order: 28-DLU65 x TOMC x 26D

Option: 28

Studio Collection Levers (except Gramercy, Grant Park, Wooster Square Series)

Function: DLU65

***Specify hand when ordering.**

Rose: TO

– Following levers not available in 32 & 32D: MA, MC, MH, MK, MM, MN, MO, MP, MQ, MS, MT, MU, MV, MX, MY, MZ, NS, NU

Lever: MC

Finish: 26D

| Options | Description | Price |
|---------|--|-------------|
| 12 | 3 Hour UL Latch | \$6.00 |
| 13 | Lockset x Front & Strike with 1/4" Radius and 2-3/8" Backset | No Addition |
| 14 | 505 Full Lip Strike | No addition |
| 20 | 2-3/8" backset latch with 1" front | No addition |
| 28 | Lockset x ANSI A-156.115 Strike – 1-1/4" Lip Standard | No addition |
| | Lip Lengths 1-1/8" or 1-3/8" | No addition |
| | Lip Lengths 1-5/8", 1-7/8", 2-1/8", 2-3/8", 2-5/8", 2-7/8" | \$14.00 |
| 31 | 1-7/8" to 2" thick door – only centered in door | No addition |
| SG | MicroShield® an antimicrobial powder coat | \$67.00 |
| TB | Through-bolting (for DLU93 function only) | \$29.00 |
| WBS | Wrought Box Strike | No Addition |

| Non-Keyed Functions | | 10BE/26D BSP/WSP | 03/04/09/10/10B/10BL/ 14/15/20D/26/32/32D |
|---------------------|----------------------------|---------------------|--|
| DLU15 | Passage | \$228.00 | \$238.00 |
| DLU15-3 | Exit or Twin Communicating | \$228.00 | \$238.00 |
| DLU65 | Privacy | \$243.00 | \$253.00 |
| * DLU93 | Single Lever Pull | \$100.00 | \$105.00 |
| ** DLU94 | Double Lever Pull | \$190.00 | \$200.00 |

* DLU93 is only available with TB option

** DLU94 is not available with any above options

BL-40 BORED LOCKS

SARGENT®

DL SERIES – STUDIO COLLECTION WOOSTER SQUARE

ASSA ABLOY

USA & Canada Prices Effective June 3, 2019



H001



H002

Rose: TO, CO, O, E2
TR, CR, LN, E3, E4 – available with DLU93 & DLU94 functions only.

Levers: H001, H002

***Specify hand when ordering.**

How to order: 28-DLU65 x E4H001 x 26D

Option: 28

Function: DLU65

Rose: E4

Lever: H001

Finish: 26D

| Options | Description | Price |
|---------|--|-------------|
| 12 | 3 Hour UL Latch | \$6.00 |
| 13 | Lockset x Front & Strike with 1/4" Radius and 2-3/8" Backset | No Addition |
| 14 | 505 Full Lip Strike | No addition |
| 20 | 2-3/8" backset latch with 1" front | No addition |
| 28 | Lockset x ANSI A-156.115 Strike – 1-1/4" Lip Standard | No addition |
| | Lip Lengths 1-1/8" or 1-3/8" | No addition |
| | Lip Lengths 1-5/8", 1-7/8", 2-1/8", 2-3/8", 2-5/8", 2-7/8" | \$14.00 |
| 31 | 1-7/8" to 2" thick door – only centered in door | No addition |
| SG | MicroShield® an antimicrobial powder coat | \$67.00 |
| TB | Through-bolting (for DLU93 function only) | \$29.00 |
| WBS | Wrought Box Strike | No Addition |

| Non-Keyed Functions | | 10BE/26D BSP/WSP | 03/04/09/10/10B/10BL/ 14/15/20D/26/32/32D |
|---------------------|----------------------------|---------------------|--|
| DLU15 | Passage | \$238.00 | \$248.00 |
| DLU15-3 | Exit or Twin Communicating | \$238.00 | \$248.00 |
| DLU65 | Privacy | \$253.00 | \$263.00 |
| * DLU93 | Single Lever Pull | \$109.00 | \$114.00 |
| ** DLU94 | Double Lever Pull | \$201.00 | \$211.00 |

* DLU93 is only available with TB option

** DLU94 is not available with any above options

DL STUDIO COLLECTION WOOSTER SQUARE & GRANT PARK

USA & Canada Prices Effective June 3, 2019



H004



H005

Rose: TO, CO, O, E2
TR, CR, LN, E3, E4 – available with DLU93 & DLU94 functions only.
Levers: H003, H004, H005, H006, H007, ▲H008, ▲H009, H010, ▲H011

How to order: 28-DLU65 x E4H004 x 26D
Option: 28
Function: DLU65
Rose: E4
Lever: H003
Finish: 26D

* Specify hand when ordering.

▲ Levers not available with DLU65 function.

| Options | Description | Price |
|---------|--|-------------|
| 12 | 3 Hour UL Latch | \$6.00 |
| 13 | Lockset x Front & Strike with 1/4" Radius and 2-3/8" Backset | No Addition |
| 14 | 505 Full Lip Strike | No addition |
| 20 | 2-3/8" backset latch with 1" front | No addition |
| 28 | Lockset x ANSI A-156.115 Strike – 1-1/4" Lip Standard | No addition |
| | Lip Lengths 1-1/8" or 1-3/8" | No addition |
| | Lip Lengths 1-5/8", 1-7/8", 2-1/8", 2-3/8", 2-5/8", 2-7/8" | \$14.00 |
| 31 | 1-7/8" to 2" thick door – only centered in door | No addition |
| SG | MicroShield® an antimicrobial powder coat | \$67.00 |
| TB | Through-bolting (for DLU93 function only) | \$29.00 |
| WBS | Wrought Box Strike | No Addition |

| Non-Keyed Functions | | 10BE/26D BSP/WSP | 03/04/09/10/10B/10BL/ 14/15/20D/26/32/32D |
|---------------------|----------------------------|---------------------|--|
| DLU15 | Passage | \$315.00 | \$325.00 |
| DLU15-3 | Exit or Twin Communicating | \$315.00 | \$325.00 |
| DLU65 | Privacy | \$328.00 | \$338.00 |
| * DLU93 | Single Lever Pull | \$186.00 | \$191.00 |
| ** DLU94 | Double Lever Pull | \$278.00 | \$288.00 |

* DLU93 is only available with TB option

** DLU94 is not available with any above options

BL-42 BORED LOCKS

SARGENT®

DL SERIES – STUDIO COLLECTION GRAMERCY SERIES

ASSA ABLOY

USA & Canada Prices Effective June 3, 2019



REM



RAM**



RGM



RAS

Rose Design:

CO
O
TO
E2
TR*
CR*
LN*
E3*

Lever Design:

REM
RAM
RAS
RGM

How to order Gramercy Series Levers:

Option: 14 x Function: DLU15 x Rose: Q x Lever: RAS x Finish: 29BK29 x Hand: RH

See below for available finishes:

Lever Design Available Finishes

| | |
|---------|----------------|
| REM-RGM | 2929 or 3030 |
| RAM | 2930* |
| RAS | 29BK29, 30BK30 |

*Two-tone - grip of lever is 32D, balance of lever is 32. Rose/escutcheon and lock finish will be 32.

See catalog for finish description.

**RAM is not available in 10BE/BSP/WSP finish.

*Roses available with DLU93 & DLU94 functions only

| Options | Description | Price |
|---------|--|-------------|
| 12 | 3 Hour UL Latch | \$6.00 |
| 13 | Lockset x Front & Strike with 1/4" Radius and 2-3/8" Backset | No Addition |
| 14 | 505 Full Lip Strike | No addition |
| 20 | 2-3/8" backset latch with 1" front | No addition |
| 28 | Lockset x ANSI A-156.115 Strike – 1-1/4" Lip Standard | No addition |
| | Lip Lengths 1-1/8" or 1-3/8" | No addition |
| | Lip Lengths 1-5/8", 1-7/8", 2-1/8", 2-3/8", 2-5/8", 2-7/8" | \$14.00 |
| 31 | 1-7/8" to 2" thick door – only centered in door | No addition |
| SG | MicroShield® an antimicrobial powder coat | \$67.00 |
| TB | Through-bolting (for DLU93 function only) | \$29.00 |
| WBS | Wrought Box Strike | No Addition |

| Non-Keyed Functions | | 10BE/BSP/WSP/629/630 |
|---------------------|----------------------------|----------------------|
| DLU15 | Passage | \$248.00 |
| DLU15-3 | Exit or Twin Communicating | \$248.00 |
| DLU65 | Privacy | \$263.00 |
| * DLU93 | Single Lever Pull | \$114.00 |
| ** DLU94 | Double Lever Pull | \$211.00 |

* DLU93 is only available with TB option

** DLU94 is not available with any above options.

DL SERIES – STUDIO COLLECTION GRAMERCY SERIES

USA & Canada Prices Effective June 3, 2019



RAL



RAG



RCM

Rose Design:

CO
O
TO
E2
TR•
CR•
LN•
E3•

Lever Design:

RAL
RAG
RCM

How to order Gramercy Series Levers:

Option: **28** x Function: **DLU15-3** x Rose: **TQ** x Lever: **RAL** x Finish: **30BN30** x Hand: **BH**

See below for available finish:

Lever Design Available Finishes

| | |
|-----|-----------------------------------|
| RAL | 29BK29, 29BN29, 30BK30, or 30BN30 |
| RAG | 2929 or 3030 |
| RCM | 2929, 3030, or 2930* |

See catalog for finish description.

•Roses available with DLU93 & DLU94 functions only

| Options | Description | Price |
|---------|--|-------------|
| 12 | 3 Hour UL Latch | \$6.00 |
| 13 | Lockset x Front & Strike with 1/4" Radius and 2-3/8" Backset | No Addition |
| 14 | 505 Full Lip Strike | No addition |
| 20 | 2-3/8" backset latch with 1" front | No addition |
| 28 | Lockset x ANSI A-156.115 Strike – 1-1/4" Lip Standard | No addition |
| | Lip Lengths 1-1/8" or 1-3/8" | No addition |
| | Lip Lengths 1-5/8", 1-7/8", 2-1/8", 2-3/8", 2-5/8", 2-7/8" | \$14.00 |
| 31 | 1-7/8" to 2" thick door – only centered in door | No addition |
| SG | MicroShield® an antimicrobial powder coat | \$67.00 |
| TB | Through-bolting (for DLU93 function only) | \$29.00 |
| WBS | Wrought Box Strike | No Addition |

| Non-Keyed Functions | | 10BE/BSP/WSP/629/630 |
|---------------------|----------------------------|----------------------|
| DLU15 | Passage | \$325.00 |
| DLU15-3 | Exit or Twin Communicating | \$325.00 |
| DLU65 | Privacy | \$338.00 |
| * DLU93 | Single Lever Pull | \$191.00 |
| ** DLU94 | Double Lever Pull | \$288.00 |

* DLU93 is only available with TB option

** DLU94 is not available with any above options.

BL-44 BORED LOCKS

SARGENT®

SIMPLI™ ROSELESS TRIM RDL SERIES COASTAL SERIES

ASSA ABLOY

USA & Canada Prices Effective June 3, 2019

Lever: G*, R, S*, Y*



RY

Collar: R

Lever: Y

*Specify hand when ordering

How to order: 28-RDLU65 x R** Y x RH x 26D

Option: 28

Function: RDLU65

Rose: R**

Lever: Y

Hand: RH

Finish: 26D

**Specify "R" for Bored Locks compatible with roseless collar.

| Options | Description | Price |
|---------|--|-------------|
| 1- | For doors 1-3/8" (35mm) thick | No addition |
| ▲ 13 | Lockset x Front & Strike with 1/4" Radius and 2-3/8" Backset | No addition |
| ▲ 14 | 505 Full Lip Strike | No addition |
| ▲ 20 | 2-3/8" backset latch with 1" front | No addition |
| ▲ 28 | Lockset x ANSI A-156.115 Strike – 1-1/4" Lip Standard | No addition |
| | Lip Lengths 1-1/8" or 1-3/8" | No addition |
| | Lip Lengths 1-5/8", 1-7/8", 2-1/8", 2-3/8", 2-5/8", 2-7/8" | \$14.00 |
| SG | MicroShield® an antimicrobial powder coat (not available with 10B) | \$67.00 |
| ▲ WBS | Wrought Box Strike | No Addition |

| | | 10BE/26D | 03/04/09/ 10/10B/10BL/ 14/15/20D/26 |
|---------------------|----------------------------|----------|---|
| Non-Keyed Functions | | BSP/WSP | |
| RDLU15 | Passage | \$262.00 | \$272.00 |
| RDLU15-3 | Exit or Twin Communicating | \$262.00 | \$272.00 |
| RDLU65 | Privacy | \$279.00 | \$289.00 |
| RDLU93 | Single Lever Pull | \$114.00 | \$119.00 |
| RDLU94 | Double Lever Pull | \$216.00 | \$226.00 |

▲ Options not available with RDLU93 and RDLU94 functions.

SIMPLÍ™ ROSELESS TRIM RDL SERIES STUDIO COLLECTION LEVERS

USA & Canada Prices Effective June 3, 2019



RME

Collar: R
Lever: ME



RMI

Collar: R
Lever: MI



RMO

Collar: R
Lever: MO

Aventura Series: MB, ME, MF, MG, MI, MW, NF
 Centro Series: MD, MJ, ND, NJ
 Notting Hill Series: MQ*, MM*, MY*
 Odeon Series: MH*, MS*, MU*, MV*, MX*, NS*, NU*
 Rialto Series: MO, MZ*
 Following levers not available in 32 & 32D: MH, MM, MO,
 MQ, MS, MU, MV, MX, MY, MZ, NS, NU

How to order: 28-RDLU65 x R** MZ x LH x 26D
 Option: 28
 Function: RDLU65
 Rose: R**
 Lever: MZ
 Hand: LH
 Finish: 26D

*Specify hand when ordering

**Specify "R" for Bored Locks compatible with roseless collar.

| Options | Description | Price |
|---------|--|-------------|
| 1- | For doors 1-3/8" (35mm) thick | No addition |
| ▲ 13 | Lockset x Front & Strike with 1/4" Radius and 2-3/8" Backset | No addition |
| ▲ 14 | 505 Full Lip Strike | No addition |
| ▲ 20 | 2-3/8" backset latch with 1" front | No addition |
| ▲ 28 | Lockset x ANSI A-156.115 Strike – 1-1/4" Lip Standard | No addition |
| | Lip Lengths 1-1/8" or 1-3/8" | No addition |
| | Lip Lengths 1-5/8", 1-7/8", 2-1/8", 2-3/8", 2-5/8", 2-7/8" | \$14.00 |
| SG | MicroShield® an antimicrobial powder coat (not available with 10B) | \$67.00 |
| ▲ WBS | Wrought Box Strike | No Addition |

| Non-Keyed | Functions | 10BE/26D BSP/WSP | 03/04/09/10/10B/ 10BL/14/15/ 20D/26/32/32D |
|-----------|----------------------------|---------------------|--|
| RDLU15 | Passage | \$262.00 | \$272.00 |
| RDLU15-3 | Exit or Twin Communicating | \$262.00 | \$272.00 |
| RDLU65 | Privacy | \$279.00 | \$289.00 |
| RDLU93 | Single Lever Pull | \$114.00 | \$119.00 |
| RDLU94 | Double Lever Pull | \$216.00 | \$226.00 |

▲ Options not available with RDLU93 and RDLU94 functions.

BL-46 BORED LOCKS

SARGENT®

8X-LINE OPTIONS

ASSA ABLOY

USA & Canada Prices Effective June 3, 2019

| Options | Description | Price |
|---------|---|----------------|
| 10 | SARGENT Signature Key System | \$58.00 / cyl. |
| 11 | SARGENT XC Key System (not available with 10, 22, 30, SC, SE, KESO options) | No addition |
| 21 | SARGENT Construction Key System (lost ball) Standard on all new systems est. since 5/1/96 | \$16.00 / cyl. |
| 22 | SARGENT Construction Key System (split key) To be used on pre-est. split key system only | \$32.00 / cyl. |
| 28 | Lockset x ANSI Strike – 1-1/4" Lip Standard | |
| | Lip Lengths 1-1/8" or 1-3/8" | \$5.00 |
| | Lip Lengths 1-5/8", 1-7/8", 2-1/8", 2-3/8", 2-5/8", 2-7/8" | \$11.00 |
| 36 | 6 Lobe security head screws | \$14.00 |
| 37 | Spanner head screws | \$14.00 |
| DG1 | Patented Degree DG1 Key System | No Addition |
| DG2 | Patented Degree DG2 Key System incorporating a locking sidebar | \$58.00/cyl. |
| DG3 | Patented Degree DG3 Key System incorporating a locking sidebar and UL437 listed | \$82.00/cyl. |
| LC | Less Cylinder | -\$87.00/cyl. |
| WBS | Wrought Box Strike | No Addition |

L - Rose - 3-1/8" Dia.
B - Knob - 2-1/4" Dia.



USA & Canada Prices Effective June 3, 2019

| <u>Function</u> | | |
|---|---|--|
| Single Cylinder | | 03/10BE/32D |
| 8XG04 | Storeroom | |
| 8XG05 | Office | \$744.00 |
| 8XG37 | Classroom | |
| Double Cylinder | | |
| 8XG17 | Asylum | \$810.00 |
| Non Keyed | | |
| 8XU15 | Passage | \$599.00 |
| 8XU65 | Privacy | \$673.00 |
| 8XU93 | Dummy Trim | \$258.00 |
| Strikes- Ordered Separate | | 03/04/10/10B/10BE/10BL 20D/32/32D/BSP/WSP |
| Number | Description | |
| 800 | ANSI T Strike Curved Lip | |
| | Furnished with Lip Length 1-1/4" standard | \$24.00 |
| | Lip Lengths 1" | \$34.00 |
| | Lip Lengths 1-1/2", 1-3/4", 2" | \$44.00 |
| 808 | ANSI Strike Curved Lip | |
| | With 1-1/4" Lip C to E Standard | \$34.00 |
| | Lip Lengths 1-1/8", 1-3/8" | \$44.00 |
| | Lip Lengths 1-5/8", 1-7/8", 2-1/8", 2-3/8", 2-5/8", 2-7/8" | \$52.00 |
| AM-0044 | Strike box – 800 strike | \$10.80 |
| 77-1141 | Strike box – 808 strike | \$10.80 |
| Please Note: Specifying lip lengths other than listed above requires extra cost and lead times. Refer to Option pages for appropriate Add if ordered with lockset. | | |
| Miscellaneous | | |
| Number | Description | 03/10BE/32D |
| 08-5285 | Screw Pack (includes 2 strikes, 2 latchbolts and 2 through-bolt screws) | \$4.80 |

BL-48 BORED LOCKS

SARGENT®

ASSA ABLOY

6-LINE OPTIONS

USA & Canada Prices Effective June 3, 2019

| Options | Variations | Price |
|---------|---|----------------|
| 10▲ | SARGENT Signature Key System | \$58.00 / cyl. |
| 11▲ | SARGENT XC Key System (not available with 10, 22, SC, SE options) | No addition |
| 13 | Lockset x Front & Strike 2-1/4" with 1/4" Radius (2-3/8" Backset Only) | No addition |
| 14 | 1/4" radius full lip strike | No addition |
| 15 | Drive-In Guarded latchbolt (2-3/8" Backset Only) | No addition |
| 17 | Lockset x 2-3/4" Backset x 2-1/4" x 1" Front | \$3.00 |
| 21▲ | SARGENT Construction Key System (lost ball) Standard on all new systems est. since 5/1/96 | \$16.00 / cyl. |
| 22▲ | SARGENT Construction Key System (split key) To be used on pre-est. split key systems only | \$32.00 / cyl. |
| 23 | Lockset x 3-3/4" Backset x 2-1/4" x 1-1/8" Front | \$10.00 |
| 24 | Lockset x 2-3/4" Backset x 2-1/4" x 1-1/8" Front | No addition |
| 28 | Lockset x ANSI A-156.115 Strike - #808 – 1-1/4" Lip Standard | |
| | Lip Lengths 1-1/8", or 1-3/8" | No addition |
| | Lip Lengths 1-5/8", 1-7/8", 2-1/8", 2-3/8", 2-5/8", 2-7/8" | \$11.00 |
| 36 | 6 Lobe security head screws | \$14.00 |
| 37 | Spanner head screws | \$9.00 |
| BR | SARGENT Bump Resistant Cyls. (N/A w/10, 22, 30, 70, 72, 73, 737P, KESO, SC, SE) | \$23.00 /cyl. |
| LC | Less Cylinder | -\$87.00/cyl. |
| SC | Schlage C Keyway Cylinder, 0-bitted | No addition |
| SE | Schlage E Keyway Cylinder, 0-bitted | No addition |
| SG | MicroShield® – an antimicrobial powder coat | \$67.00 |
| WBS | Wrought Box Strike | No Addition |

▲ Options not available for 50 function

6-LINE – KNOB DESIGN

USA & Canada Prices Effective June 3, 2019



| <u>Function</u> | | O, B - Rose / B, S, Knob Finish | |
|-----------------|--------------------|------------------------------------|-----------------|
| Single Cylinder | | 10BE/26D | 03/04/10/10B/26 |
| 6G04 | Storeroom | | |
| 6G05 | Office | \$275.00 | \$280.00 |
| 6G37 | Classroom | | |
| 6G24 | Dormitory | | |
| 6G38-2 | Twin Communicating | \$326.00 | \$332.00 |
| 6G50 | Hotel | | |
| Non Keyed | | | |
| 6U15 | Passage | \$176.00 | \$186.00 |
| 6G15 | Passage | | |
| 6G15-3 | Exit | \$200.00 | \$208.00 |
| 6U65 | Privacy | | |
| 6G75-2 | Twin Communicating | \$204.00 | \$215.00 |
| 6U93 | Single Knob Pull | \$85.00 | \$88.00 |
| 6U94 | Double Knob Pull | \$171.00 | \$182.00 |

NOTE: Split finishes are available, price as higher finish. Order outside/inside and handing must be specified. Strike and latch front will match inside finish for RH/LH and outside finish for RHR/LHR.

| <u>Strikes</u> | | | |
|----------------|--|----------|---------------------|
| Number | Description | | |
| 800 | ANSI Strike Curved Lip Furnished with Lip Length 1-1/4" Standard Lip Lengths 1" Lip Lengths 1-1/2", 1-3/4", 2" | | Refer to page BL-47 |
| 808 | ANSI Curved Lip (28- Option) Lip Length 1-1/4" Standard Lip Lengths 1-1/8" or 1-3/8" Lip Lengths 1-5/8", 1-7/8", 2-1/8", 2-5/8", 2-7/8" | | Refer to page BL-47 |
| AM-0044 | Strike box – standard | | \$10.80 |
| 77-1141 | Strike box – 808 strike | | \$10.80 |
| Number | Description | 10BE/32D | 03/04/10/10B/32 |
| 506 | Full Lip Strike (14 Option) | \$16.00 | \$19.00 |

* Handed – please specify hand when ordering.

BL-50 BORED LOCKS

SARGENT®

6-LINE LATCHES/DOOR KIT

ASSA ABLOY

USA & Canada Prices Effective June 3, 2019

| Latch Tubes | | Specify Finish | |
|---|-------------------|---------------------------|---------------------|
| Standard 2 - 3/8" Backset x 2 - 1/4" x 1" Front | | 03/10/10B/10BE/32D | |
| 06-5083 | Guarded | | \$40.05 |
| 06-5225 | Unguarded | | \$33.10 |
| 13 Option - 2 - 3/8" Backset x 2 - 1/4" x 1" x 1/4" Radius Front | | 03/10/10B/10BE/32D | |
| 06-5085 | Guarded | | \$40.05 |
| 06-5227 | Unguarded | | \$33.10 |
| 15- Option - Drive - in 2-3/8" Backset | | 32D | |
| 06-5100 | Guarded | | \$40.05 |
| 17 Option - 2 - 3/4" Backset x 2 - 1/4" x 1" Front | | 03/10/10B/10BE/32D | |
| 06-5102 | Guarded | | \$45.03 |
| 06-5234 | Unguarded | | \$38.07 |
| 23 Option - 3 - 3/4" Backset x 2 - 1/4" x 1 - 1/8" Front | | 03/10/10B/10BE/32D | |
| 06-5096 | Guarded | | \$45.03 |
| 06-5232 | Unguarded | | \$38.07 |
| 24 Option - 2 - 3/4" Backset x 2 - 1/4" x 1 - 1/8" Front | | 03/10/10B/10BE/32D | |
| 06-5094 | Guarded | | \$40.05 |
| 06-5231 | Unguarded | | \$33.10 |
| Latch Tube Sleeve | | | |
| 06-0578 | | | \$3.32 |
| Miscellaneous | | 10BE/26D | 03/10/10B/26 |
| 530 | Rabbeted Door Kit | \$59.00 | \$70.00 |

USA & Canada Prices Effective June 3, 2019

Note: All parts listed below are for product manufacturing after January, 2003

| <u>Part No.</u> | | <u>Price</u> |
|-----------------|----------------------------------|--------------|
| AM-0044 | Strike Box (Standard) | \$10.80 |
| 01-1156 | Mounting Screw | \$0.71 |
| .01-1168 | Mounting Screw | \$0.67 |
| .01-1169 | Mounting Screw | \$1.09 |
| *01-5000 | Mounting Screw | \$0.81 |
| *06-0500 | Cylinder Knob "B" O/S + I/S | \$32.47 |
| *06-0501 | Button Knob "B" O/S + I/S | \$32.47 |
| *06-0502 | Plain Knob "B" O/S + I/S | \$32.47 |
| *06-0503 | Cylinder Knob "S" O/S + I/S | \$32.47 |
| *06-0504 | Button Knob "S" O/S + I/S | \$32.47 |
| *06-0505 | Plain Knob "S" O/S + I/S | \$32.47 |
| *06-0512 | Knob Collar "B" | \$6.96 |
| .06-0525 | Knob Catch Stop | \$3.49 |
| *06-0528 | Knob Collar "S" | \$6.96 |
| *06-2675 | Screw Pack (Except 75-2, 93, 94) | \$5.31 |
| .06-5003 | Mtg. Plate (B+O Rose) | \$8.28 |
| *06-5005 | Outside Rose "B" | \$21.53 |
| *06-5006 | Outside Rose "O" | \$21.53 |
| *06-5011 | Lockbody (B, S-Knob) 15 | \$134.13 |
| *06-5012 | Lockbody (S-Knob) 05 | \$134.13 |
| *06-5013 | Lockbody (S-Knob) 24 | \$134.13 |
| *06-5016 | Lockbody (S-Knob) 04 | \$134.13 |
| *06-5017 | Lockbody (B, S-Knob) 15-3 | \$134.13 |

| <u>Part No.</u> | | <u>Price</u> |
|-----------------|----------------------------------|--------------|
| *06-5018 | Lockbody (S-Knob) 38-2 | \$134.13 |
| *06-5019 | Lockbody (S-Knob) 65 | \$134.13 |
| *06-5020 | Lockbody (S-Knob) 75-2 | \$134.13 |
| *06-5040 | Lockbody (B-Knob) 05 | \$120.87 |
| *06-5041 | Lockbody (B-Knob) 24 | \$120.87 |
| *06-5043 | Lockbody (B-Knob) 50 | \$120.87 |
| *06-5044 | Lockbody (B-Knob) 65 | \$120.87 |
| *06-5045 | Lockbody (B-Knob) 75-2 | \$120.87 |
| *06-5054 | Blank Rose "B" (15-3 function) | \$16.56 |
| .06-5056 | Lockset Screw Pack (Standard) | \$4.30 |
| .06-5057 | Turn Knob Assembly Screw Pack | \$6.96 |
| *06-5058 | Dummy Trim Lg Rose Screw Pk | \$1.81 |
| .06-5059 | Dummy Trim Reg Rose Screw Pk | \$1.81 |
| .06-5069 | Mounting Plate "E, L" | \$41.40 |
| *06-5129 | Inside "O" Rose Assy | \$21.53 |
| *06-5130 | Inside "B" Rose Assy | \$21.53 |
| 06-5147 | Pin Asy. - Rem. Core | \$27.35 |
| *06-5215 | Lockbody (S-Knob) 37 | \$134.12 |
| *06-5240 | Lockbody (B-Knob) 37 | \$120.87 |
| *06-5241 | Lockbody (B-Knob) 38-2 | \$120.87 |
| *06-5349 | Turn Button Assembly | \$2.07 |
| 14-0299 | Lock-Out Key (50 function) | \$4.95 |
| 14-0300 | Emergency Key (65 function only) | \$0.50 |

Note: Rose designs "B" and "O" are not interchangeable with "E" and "L" designs. They require different lock bodies.

*Specify hardware finish required. Consult catalog for available finishes

USA & Canada Prices Effective June 3, 2019

MORTISE LOCKS 7800/8200

How to Order/ANSI Finish & Function Comparison ML-1

8200-Line

| | |
|--|-------|
| Options | ML-2 |
| 8200: Rose x A, E, F, W Lever | ML-3 |
| Options | ML-4 |
| NAC 8200: Rose x A, E, F, W Lever | ML-5 |
| Options | ML-6 |
| 8200: Rose x B, L, P Levers | ML-7 |
| Options | ML-8 |
| NAC 8200: Rose x B, L, P Levers | ML-9 |
| Options | ML-10 |
| 8200: Rose x J Lever | ML-11 |
| Options | ML-12 |
| NAC 8200: Rose x J Lever | ML-13 |
| Options | ML-14 |
| 8200: LE1, LE2, LE3, LE4 | |
| Escutcheon x A, B, E, F, J, L, P, W Levers | ML-15 |
| Options | ML-16 |
| NAC 8200: LE1, LE2, LE3, LE4 | |
| Escutcheon x A, B, E, F, J, L, P, W Levers | ML-17 |
| Options | ML-18 |
| 8200: LW1 Escutcheon x A, B, E, F, J, L, P, W Levers | ML-19 |
| Options | ML-20 |
| NAC 8200: LW1 | |
| Escutcheon x A, B, E, F, J, L, P, W Levers | ML-21 |
| Options | ML-22 |
| 8200: WT Escutcheon x A, B, E, F, J, L, P, W Lever | ML-23 |
| Options | ML-24 |
| NAC 8200: WT | |
| Escutcheon x A, B, E, F, J, L, P, W Lever | ML-25 |
| Options | ML-26 |
| 8200: LS Escutcheon x A, B, E, F, J, L, P, W Levers | ML-27 |
| 8200 Freewheeling Options | ML-28 |
| 8200: Freewheeling FE | |
| Escutcheon x A, B, E, F, J, L, P, W Levers | ML-29 |
| Options | ML-30 |
| 8200: Coastal Series Design - Rose x Lever | ML-31 |
| Options | ML-32 |
| NAC 8200: Coastal Series Design - Rose x Lever | ML-33 |
| Options | ML-34 |
| 8200: Coastal Series Design - Escutcheon x Lever | ML-35 |
| Options | ML-36 |
| NAC 8200: Coastal Series Design - Escutcheon x Lever | ML-37 |
| Options | ML-38 |
| 8200 Studio Collection | ML-39 |
| Options | ML-40 |
| 8200 Studio Collection | ML-41 |
| 8200 Studio Collection Options | ML-42 |

| | |
|---|-------|
| 8200 Studio Collection x Rose | ML-43 |
| Options | ML-44 |
| 8200 Studio Collection | ML-45 |
| 8200 Studio Collection Options | ML-46 |
| 8200 Studio Collection x Rose | ML-47 |
| 8200 Studio Collection Options | ML-48 |
| NAC 8200 Studio Collection x Rose | ML-49 |
| 8200 Studio Collection Options | ML-50 |
| 8200 Studio Collection x Rose | ML-51 |
| 8200 Studio Collection Options | ML-52 |
| 8200 Studio Collection x Escutcheon | ML-53 |
| 8200 Studio Collection Options | ML-54 |
| 8200 Studio Collection x Escutcheon | ML-55 |
| 8200 Studio Collection Options | ML-56 |
| NAC 8200 Studio Collection x Escutcheon | ML-57 |
| 8200 Gramercy Series Options | ML-58 |
| 8200 Gramercy Series x Rose | ML-59 |
| 8200 Gramercy Series Options | ML-60 |
| NAC 8200 Gramercy Series x Rose | ML-61 |
| 8200 Gramercy Series Options | ML-62 |
| 8200 Gramercy Series x Rose | ML-63 |
| 8200 Gramercy Series Options | ML-64 |
| NAC 8200 Gramercy Series x Rose | ML-65 |
| 8200 Gramercy Series Options | ML-66 |
| 8200 Gramercy Series x Escutcheon | ML-67 |
| 8200 Gramercy Series Options | ML-68 |
| NAC 8200 Gramercy Series x Escutcheon | ML-69 |
| 8200 Gramercy Series Options | ML-70 |
| 8200 Gramercy Series x Escutcheon | ML-71 |
| 8200 Gramercy Series Options | ML-72 |
| NAC 8200 Gramercy Series x Escutcheon | ML-73 |
| 8200 Roseless – Coastal Series Options | ML-74 |
| R8200: Coastal Series Design – Roseless Collar | ML-75 |
| 8200 Roseless – Studio Collection Options | ML-76 |
| R8200 Studio Collection – Roseless Collar | ML-77 |
| 8200 Roseless – Studio Collection & Coastal Options | ML-78 |
| NAC R8200 Studio Collection & Coastal – Roseless Collar | ML-79 |

7800-Line

| | |
|---------------------------------------|-------|
| Options | ML-80 |
| 7800: Rose x B, C Knob | ML-81 |
| Options | ML-82 |
| 7800: KW1, KE1, KE2, KE3, KE4 | |
| Escutcheon x B, C Knob | ML-83 |
| Options | ML-84 |
| 7800: WT Escutcheon x B, C Knob | ML-85 |
| Options | ML-86 |
| 7800: KS Escutcheon x K Knob | ML-87 |
| Options | ML-88 |
| 7800: SL Rose x D Knob | ML-89 |
| 8200 Deadlocks | ML-90 |

USA & Canada Prices Effective June 3, 2019

Distributor Bulk Pack Trim Program

| | |
|--|-------|
| Features | ML-91 |
| 8200/7800 Distributor Bulk Pack - Lockbodies | ML-92 |
| 8200 Trim Packs | ML-93 |
| 8200 7800 Trim Packs | ML-94 |
| 7800/8200 Lockbodies | ML-95 |

7800/8200 Working Trim Sets

| | |
|--------------------------------------|--------|
| 8200 Trim Set Program Features | ML-96 |
| 8200 Inside Trim Set..... | ML-97 |
| 8200 Inside Trim Set..... | ML-98 |
| 8200 Inside trim Set | ML-99 |
| 8200 Inside Trim Set..... | ML-100 |
| 8200 Outside Trim Set | ML-101 |
| 8200 Outside Trim Set | ML-102 |
| 8200 Outside Trim Set..... | ML-103 |
| 7800 Inside Trim Set..... | ML-104 |
| 7800 Inside Trim Set..... | ML-105 |
| 7800 Outside Trim Set | ML-106 |
| 7800 Outside Trim Set | ML-107 |

7800/8200 Assemblies & Parts

| | |
|--|--------|
| 8200 Levers..... | ML-108 |
| 8200 Levers..... | ML-109 |
| 8200 Milled Levers & 7800 Knobs | ML-110 |
| 8200/7800 Inside Escutcheons | ML-111 |
| 8200/7800 Inside Escutcheons | ML-112 |
| 8200/7800 Outside Escutcheons | ML-113 |
| 8200/7800 Outside Escutcheons | ML-114 |
| 7800/8200 Roses/Turns | ML-115 |
| 7800/8200 Mounting Kits | ML-116 |
| 8200 Strikes & 7700/8100 Spindles/Strikes..... | ML-117 |

8200/7800 Parts

| | |
|-------------------------|--------|
| 01-0010 to 82-0009..... | ML-118 |
| 82-0017 to 82-3085..... | ML-119 |
| 82-3088 to 97-0478..... | ML-120 |

MORTISE LOCKS 7900

| | |
|--|--------|
| How to Order/ANSI Finish & Function Comparison | ML-121 |
|--|--------|

7900 Mortise Lock

| | |
|--|--------|
| 7900 Series Lever Locks Options | ML-122 |
| 7900 Series Rose x Levers | ML-123 |
| 7900 Series LW1 Escutcheon Lever Locks Options..... | ML-124 |
| 7900 Series LW1 Escutcheon Lever Locks | ML-125 |
| 7900 Series WT Escutcheon Lever Locks Options | ML-126 |
| 7900 Series WT Escutcheon Lever Locks | ML-127 |
| 7900 Series WT Escutcheon Lever Locks Options | ML-128 |
| 7900 Series WT Escutcheon Lever Locks | ML-129 |
| 7900 Series WT Escutcheon Lever Locks Options | ML-130 |
| 7900 Series WT Escutcheon Lever Locks | ML-131 |
| 7900 Series Studio Collection Lever Locks Options..... | ML-132 |
| 7900 Series Studio Collection Lever Locks | ML-133 |

| | |
|---|--------|
| 7900 Series Studio Collection Lever Locks Options..... | ML-134 |
| 7900 Series Studio Collection Lever Locks | ML-135 |
| 7900 Series Studio Collection Lever Locks Options..... | ML-136 |
| 7900 Series Studio Collection Lever Locks | ML-137 |
| 7900 Series Studio Collection Lever Locks Options..... | ML-138 |
| 7900 Series Studio Collection Lever Locks | ML-139 |
| 7900 Series Studio Collection Lever Locks Options..... | ML-140 |
| 7900 Series Studio Collection Lever Locks | ML-141 |
| 7900 Series Studio Collection Lever Locks Options..... | ML-142 |
| 7900 Series Studio Collection Lever Locks | ML-143 |
| 7900 Series Studio Collection Lever Locks Options | ML-144 |
| 7900 Series Studio Collection Lever Locks | ML-145 |
| 7900 Series Studio Collection Lever Locks Options | ML-146 |
| 7900 Series Studio Collection | ML-147 |

Escutcheon Lever Locks

| | |
|---|--------|
| 7900 Series Knob Locks Options..... | ML-148 |
| 7900 Series Rose x B Knob..... | ML-149 |
| 7900 Series KW1 Escutcheon Knob Lock Options..... | ML-150 |
| 7900 Series KW1 Escutcheon Knob Lock | ML-151 |
| 7900 Series WT Escutcheon Knob Lock Options..... | ML-152 |
| 7900 Series WT Escutcheon Knob Lock | ML-153 |
| 7900 Series Lockbodies | ML-154 |

HIGH SECURITY MORTISE LOCK 9200

| | |
|---|--------|
| How to Order - ANSI Finish & Function | |
| Comparison 9200 and M9200 - Levers..... | ML-155 |

9200 and M9200 - Levers

| | |
|--|--------|
| Options-9200..... | ML-156 |
| 9200: LN, L, Rose x B, J, L, P Levers | ML-157 |
| Options-9200..... | ML-158 |
| 9200: SN, SL, Rose x B, J, L, P Levers..... | ML-159 |
| Options | ML-160 |
| 9200: LE3, LE4 Escutcheon x B, J, L, P Levers..... | ML-161 |
| Options-9200..... | ML-162 |
| 9200: LS Escutcheon x B, J, L, P Levers | ML-163 |

9200 & M9200 - Knobs

| | |
|--|--------|
| Options-9200..... | ML-164 |
| 9200: SL, SN, Rose x K Knob | ML-165 |
| Options-9200..... | ML-166 |
| 9200: LS Escutcheon x K Knob | ML-167 |
| Options-9200..... | ML-168 |
| 9200: SL Rose x D Knob | ML-169 |
| Options-9200 Rose BHD Knob | ML-170 |
| 9200: 9200 Rose BHD Knob..... | ML-171 |
| Options-9200 Behavioral Health (BHW) | ML-172 |
| 9200 Behavioral Health (BHW) | ML-173 |
| 9200 Deadlock/Lock Bodies..... | ML-174 |
| 9200 Parts..... | ML-175 |
| 9200 Inside Trim Set..... | ML-176 |
| 9200 Outside Trim Set | ML-177 |

USA & Canada Prices Effective June 3, 2019

How to Order

| Step | Description | Example |
|---|--|---|
| Quantity | Each | 10 Ea. |
| Option | Consult catalog for options available | 10 Ea. 75- |
| Product Series | 8200 Levers, 7800 Knobs | 10 Ea. 75-82 |
| Function | Consult catalog for functions available | 10 Ea. 75-8205 |
| Trim | Consult catalog for trims available | 10 Ea. 75-8205 LNL |
| Finish | Consult catalog for finishes available | 10 Ea. 75-8205 LNL US26D |
| Hand | Consult catalog for handing requirements | 10 Ea. 75-8205 LNL US26D RH |
| Options | Consult factory for options available | 10 Ea. 75-8205 LNL US26D RH x 1 ^{3/8"} Lip Strike |
| When ordering split finishes specify outside finish first | | 10 Ea. 75-8205 LNL US3 x US26D RH |

To price split trim/finish, defaults to higher price.

Locksets in combinations not listed should be figured by adding together the prices of the component parts.

If by any method of figuring, lower prices can be obtained than set prices shown, set prices will prevail.

It is not permissible to take full deduction for omission of a component from a lockset.

Prices are for 1-3/4" door. For other door thicknesses not listed herein, please consult factory.

ANSI Finish and Function Comparison

| Function | | Finish | | |
|----------|---------|---------|------|---|
| SARGENT | ANSI | SARGENT | ANSI | Description |
| 15 | F01 | US3 | 605 | Polished brass, clear coated |
| 68 | F02 | US4 | 606 | Satin brass, clear coated |
| 05, 55 | F04 | US9 | 611 | Polished bronze, clear coated |
| 37 | F05 | US10 | 612 | Satin Bronze, clear coated |
| 89 | F06 | US10B | 613 | Oxidized Satin Bronze/Oil Rubbed |
| 04 | F07 | US10BE | 613E | Dark Oxidized Satin Bronze - Equivalent |
| 47 | F08/F10 | US10BL | --- | Oxidized Satin Bronze, clear coated |
| 14 | | US14 | 618 | Bright nickel, clear coated |
| 16 | F09 | US15 | 619 | Satin nickel, clear coated |
| 46 | F11 | US20D | --- | Statuary dark bronze, clear coated |
| 45 | F12 | US26 | 625 | Polished chrome |
| 25 | F13 | US26D | 626 | Satin chrome |
| 26 | F14 | US32 | 629 | Polished stainless steel |
| 50 | F15 | US32D | 630 | Satin stainless steel |
| 22 | F16 | BSP | --- | Black Suede Powder Coat |
| 21 | F17 | WSP | --- | White Suede Powder Coat |
| 20 | F18 | | | |
| 66 | F19 | | | |
| 43 | F20 | | | |
| 24 | F21 | | | |
| 65 | F22 | | | |
| 67 | F26 | | | |
| 03 | F29 | | | |
| 17 | F30 | | | |
| 13 | F31 | | | |
| 38 | F32 | | | |
| 39 | F33 | | | |
| 40 | F34 | | | |
| 48 | F35 | | | |

Refer to ML-89 for multi-function cross-reference

ML-2 MORTISE LOCKS

SARGENT®

ASSA ABLOY

OPTIONS

USA & Canada Prices Effective June 3, 2019

| Options | Description | Price |
|----------|--|---|
| 1▲ | 8200 Line with 1-1/16" wide front for 1-3/8" doors. | \$58.00 |
| 3 | Stainless steel hub (not available with 8289, 8291 & 8292 functions) | \$63.00 |
| 10▲ | SARGENT Signature Key System | \$58.00 / cyl. |
| 11†▲ | SARGENT XC Key System (not available w/10, KESO, SC, SE) | No addition |
| 1160 | SARGENT XC Large Format Interchangeable Plastic Disposable Construction Core | No addition |
| 1163 | SARGENT XC Large Format Interchangeable Core Cylinder - Includes masterkeying charges | \$77.00 |
| 1164 | SARGENT XC Large Format Interchangeable Construction Core Cylinder | \$77.00 |
| 1170 | Small Format interchangeable disposable construction core - to accept 7 Pin XC permanent core | No addition |
| 11727P | Small Format interchangeable keyed construction core - to accept 7 Pin XC permanent core | \$69.00 |
| 11737P | Small Format interchangeable core - to accept 7 pin XC permanent core | \$69.00 / cyl. |
| 21▲† | SARGENT Construction Key System (lost ball) Standard on all new systems established since 5/1/96 | \$16.00 / cyl. |
| 22▲† | SARGENT Construction Key System (split key) To be used on pre-established split key systems only | \$32.00 / cyl. |
| 23 | Locksets with flat 4 7/8" ANSI strike | No addition |
| 31 | Thick Doors - Extended Lip Required - Specify Length C to E - Cylinders - IMPORTANT- See catalog 7800/8200 option page for cylinder limitations - Below charges DO NOT include additional charges for special cylinder requirements Doors up to 2-1/2" thick - lock centered Doors 2-5/8" to 6" thick OR doors 1-3/4" thick w/max 1" paneling one side. For example: Specify 1-3/4" door with panel (Side) on inside or outside | No addition Non Keyed function \$50.00 Keyed function \$100.00 |
| 36 | 6 Lobe security head screws | \$23.00 |
| 37 | Spanner head screws | \$16.00 |
| 49 | Visual Status Indicator - Available with 30, 36, 37 function - Rose Trims CR, E, L, LN, O, TR - Available with 26, 29, 38, 39 40, 41 functions - Rose Trim 8200 LN | \$92.00 \$92.00 |
| 49 | Occupancy Indicator with emergency Release - Available with 65, 66, 68 functions; Rose Trims 7800 CR, E, L, LN, O, TR | \$92.00 |
| 50 | Secured Indicator Rose- doors 1-5/8" to 2-1/4" thick- Avail.w/24,25,26,28,29,30,36,37,38,39,40,41,43,45,50,51,52,57,58,67 functions | \$62.00 |
| 60 | SARGENT Large Format Interchangeable Plastic Disposable Construction Core | No addition |
| 63 | SARGENT Large Format Interchangeable core cylinder, includes master keying charges | \$77.00 / cyl |
| 64 | SARGENT Large Format Interchangeable Construction Core Cylinder | \$77.00 |
| 6573▲† | Small Format 6-Pin Uncombined Core (Refer to CK-12) | \$59.00 / cyl. |
| 65737P▲† | Small Format 7-Pin Uncombined Core (Refer to CK-12) | \$59.00 / cyl. |
| 68 | 8200 Line furnished with lever handle outside x knob inside (Excludes SLD Detention Knob) | Defaults to 8200 Lever Lock Price |
| 69 | 8200 Line furnished with lever handle inside x knob inside (Excludes SLD Detention Knob) | Defaults to 8200 Lever Lock Price |
| 70▲† | Small Format interchangeable disposable plastic construction core | No addition |
| 72▲† | Small Format interchangeable 6-Pin construction core | \$69.00 |
| 73▲† | Small Format interchangeable core 6-pin Includes MK and GMK keying charges | \$69.00 / cyl |
| 737P▲† | Small Format interchangeable core 7-pin (refer to CK-12 for available keyways) Includes MK and GMK keying charges | \$69.00 / cyl |
| 74 | Lock case wrapped in lead - handing required (roses not available) | \$272.00 |
| 75 | Tactile Warning - Milled Inside Lever | \$72.00 |
| 76 | Tactile Warning - Milled Outside Lever | \$72.00 |
| 77 | Tactile Warning - Milled Outside and Inside Lever | \$144.00 |
| 81▲† | Cylinder to accept Keso (83) and Keso F1 (F183) removable core - no core provided | No addition |
| F182† | SARGENT Keso Security Cylinder - patented - new key systems | \$84.00 / cyl. |
| F183▲† | SARGENT Keso Security Removable Core Cylinder - patented - new key systems | \$120.00 / cyl. |
| 82† | SARGENT Keso Security Cylinder (For existing systems only) | \$84.00 / cyl. |
| 83▲† | SARGENT Keso Security Removable Core Cylinder (For existing systems only) | \$120.00 / cyl. |
| 84▲† | SARGENT Keso Security Removable Construction Core Cylinder | See CK-18 |
| 85 | Tactile Warning - Abrasive Coating on Inside Lever | \$45.00 |
| 86 | Tactile Warning - Abrasive Coating on Outside Lever | \$45.00 |
| 87 | Tactile Warning - Abrasive Coating on Outside & Inside Lever | \$90.00 |
| AV | Anti Vandal Pull Trim (available in 32D finish), (Not available with 8270, 8271, 8272, 8273 functions) | \$212.00 |
| BR | SARGENT Bump Resistant Cylinders (N/A w/10, 22, 30, 60, 63, 64, 70, 72, 73, 737P, KESO, SC, & SE options) | \$23.00 /cyl. |
| DG1 | Patented Degree DG1 Key System | No Addition |
| DG160 | Hardware prepared for DG1-6300 Lg. Format IC cores, supplied with temporary plastic construction cores | No addition |
| DG163 | Patented Degree DG1 Large Format Interchangeable Core Cylinder - Includes master keying charges | \$77.00 |
| DG164 | Hardware prepared for DG1-6300 Lg. Format IC cores, supplied with temporary keyed construction cores | \$77.00 |
| DG2 | Patented Degree DG2 Key System incorporating a locking sidebar | \$58.00/cyl. |
| DG260 | Hardware prepared for DG2-6300 Lg. Format IC cores, supplied with temporary plastic construction cores | No addition |
| DG263 | Patented Degree DG2 Large Format Interchangeable Core Cylinder - Includes master keying charges | \$135.00 |
| DG264 | Hardware prepared for DG2-6300 Lg. Format IC cores, supplied with temporary keyed construction cores | \$77.00 |
| DG3 | Patented Degree DG3 Key System incorporating a locking sidebar and UL437 listed | \$82.00/cyl. |
| DG360 | Hardware prepared for DG3-6300 Lg. Format IC cores, supplied with temporary plastic construction cores | No addition |
| DG363 | Patented Degree DG3 Large Format Interchangeable Core Cylinder - Includes master keying charges | \$159.00 |
| DG364 | Hardware prepared for DG3-6300 Lg. Format IC cores, supplied with temporary keyed construction cores | \$77.00 |
| DX | Deadbolt Monitoring (not available with 50, 74) | \$182.00 |
| LB | Extra large thumbturn | \$16.00 |
| LC | Less Cylinder | -\$89.00/cyl. |
| LX | Latchbolt Monitor - available with all non-deadbolt functions; not available with DX option | \$185.00 |
| OBS | Open Back Strike | \$73.00 |
| RX | Request to Exit | \$190.00 |
| SC▲† | Schlage "C" Keyway cylinder, (Number 41 Cylinder Only, 0 bitted) | No addition |
| SE▲† | Schlage "E" Keyway cylinder, (Number 41 Cylinder Only, 0 bitted) | No addition |
| SG | MicroShield® - an antimicrobial powder coat finish | \$67.00 |
| WBS | Wrought Box Strike | No addition |

NOTES: ▲ Options not avail. with a standard 50 function lockout cylinder. † Not avail. with 60, 63, 64 options

| | | |
|-----|--|---------|
| CPC | Clear Powder Coat over 26D/32D - 8205 x LNA x RH x 32D x CPC All orders will continue to be handled as a "special" when CPC is ordered. | \$62.00 |
|-----|--|---------|

ASSA ABLOY

8200

USA & Canada
Prices Effective
June 3, 2019



Rose: O, E, L, LN (Shown) Levers: A, E, F, W (All Shown)

| Function | | Finish | |
|---|------------------------------------|------------------|--|
| | | 10BE/26D/BSP/WSP | 03/04/09/10/10B/10BL/14/15/20D/26/32/32D |
| Single Cyl | | | |
| 8204 | Storeroom or Closet | | |
| 8205 | Office or Entry | \$1,006.00 | \$1,030.00 |
| 8237 | Classroom | | |
| 8255 | Office or Entry | | |
| <hr/> | | | |
| 8206 | Storeroom or Service | | |
| 8231 | Utility | | |
| 8236 | Closet | | |
| 8256 | Office or Inner Entry | \$1,031.00 | \$1,055.00 |
| 8257, 8258, 8267 | Institutional Privacy | | |
| 8289 | Holdback | | |
| 8291 | All Purpose Holdback | | |
| <hr/> | | | |
| Single Cyl With Deadbolt | | | |
| 8224 | Room Door | | |
| 8225 | Dormitory or Exit | | |
| 8227 | Closet or Storeroom | | |
| 8228, 8230 | Dummy Trim Deadlock | \$1,060.00 | \$1,084.00 |
| 8235 | Storeroom | | |
| 8243 | Apartment Corridor | | |
| 8245 | Dormitory or Exit | | |
| 8247 | Front Door or Apartment Corridor | | |
| 8251 | Storeroom Deadbolt | | |
| 8250 | Hotel Guest Lock | \$1,092.00 | \$1,116.00 |
| <hr/> | | | |
| Double Cyl No Deadbolt | | | |
| 8216 | Apartment or Exit or Public Toilet | | |
| 8217 | Asylum or Institutional | | |
| 8238 | Classroom Security Intruder | \$1,108.00 | \$1,132.00 |
| 8259 | School Security | | |
| 8290 | Classroom Security Holdback | | |
| 8292 | All Purpose Holdback | | |
| <hr/> | | | |
| Double Cyl With Deadbolt | | | |
| 8226 | Store Door | | |
| 8229 | Dummy Trim Deadlock | | |
| 8239, 8240 | Classroom Security Intruder | | |
| 8241 | Classroom Security | \$1,129.00 | \$1,153.00 |
| 8246 | Dormitory or Exit | | |
| 8248 | Store Door | | |
| 8249 | Security Deadbolt | | |
| 8252 | Institutional | | |
| <hr/> | | | |
| Electro Mechanical Single Cyl – Specify 12V or 24V | | | |
| 8270-12V / 8270-24V | Fail Safe | \$1,202.00 | \$1,226.00 |
| 8271-12V / 8271-24V | Fail Secure | | |
| <hr/> | | | |
| Electro Mechanical Double Cyl – Specify 12V or 24V | | | |
| 8272-12V / 8272-24V | Fail Safe | \$1,259.00 | \$1,283.00 |
| 8273-12V / 8273-24V | Fail Secure | | |
| <hr/> | | | |
| Non Keyed | | | |
| 8213 | Communication or Exit | \$806.00 | \$830.00 |
| 8215 | Passage or Closet | | |
| 8265 | Privacy Bedroom or Bath (Latch) | \$887.00 | \$911.00 |
| 8266, 8268 | Privacy Bedroom or Bath (Deadbolt) | \$983.00 | \$1,007.00 |
| 8293* | Single Dummy Trim | \$333.00 | \$345.00 |
| 8294 | Double Dummy Trim | \$665.00 | \$689.00 |
| 8295 | Single Dummy Trim w/Lockbody | \$427.00 | \$439.00 |
| 8296 | Double Dummy Trim w/Lockbody | \$763.00 | \$787.00 |
| 8297 | Double Dummy w/Active Trim | \$846.00 | \$870.00 |

**A" Lever Only—Specify hand and if for inside or outside of door, when ordering.

ML-4 MORTISE LOCKS

SARGENT®

OPTIONS USA & Canada Prices Effective June 3, 2019

ASSA ABLOY

| Options | Description | Price |
|----------|--|---|
| 1▲ | 8200 Line with 1-1/16" wide front for 1-3/8" doors. | \$58.00 |
| 3 | Stainless steel hub (not available with 8289, 8291 & 8292 functions) | \$63.00 |
| 10▲ | SARGENT Signature Key System | \$58.00 / cyl. |
| 11†▲ | SARGENT XC Key System (not available w/10, KESO, SC, SE) | No addition |
| 1160 | SARGENT XC Large Format Interchangeable Plastic Disposable Construction Core | No addition |
| 1163 | SARGENT XC Large Format Interchangeable Core Cylinder - Includes masterkeying charges | \$77.00 |
| 1164 | SARGENT XC Large Format Interchangeable Construction Core Cylinder | \$77.00 |
| 1170 | Small Format interchangeable disposable construction core - to accept 7 Pin XC permanent core | No addition |
| 11727P | Small Format interchangeable keyed construction core - to accept 7 Pin XC permanent core | \$69.00 |
| 11737P | Small Format interchangeable core - to accept 7 pin XC permanent core | \$69.00 / cyl. |
| 21▲† | SARGENT Construction Key System (lost ball) Standard on all new systems established since 5/1/96 | \$16.00 / cyl. |
| 22▲† | SARGENT Construction Key System (split key) To be used on pre-established split key systems only | \$32.00 / cyl. |
| 23 | Locksets with flat 4 7/8" ANSI strike | No addition |
| 31 | Thick Doors - Extended Lip Required - Specify Length C to E IMPORTANT: See 7800/8200 Catalog Option Page for Cylinder Limits - DOES NOT include additional Charges for Special Cylinder Requirements | No addition |
| | Doors up to 2-1/2" thick - lock centered • Doors 2-5/8" to 6" thick OR doors 1-3/4" thick w/max 1" paneling one side. For example: Specify 1-3/4" door with panel (Side) on inside or outside | Non Keyed function \$50.00 Keyed function \$100.00 |
| 36 | 6 Lobe security head screws | \$23.00 |
| 37 | Spanner head screws | \$16.00 |
| 49 | Visual Status Indicator - Available with 30, 36, 37 function - Rose Trims CR, E, L, LN, O, TR - Available with 26, 29, 38, 39 40, 41 functions - Rose Trim 8200 LN | \$92.00 |
| 49 | Occupancy Indicator with emergency Release - Available with 65, 66, 68 functions; Rose Trims 7800 CR, E, L, LN, O, TR | \$92.00 |
| 50 | Secured Indicator Rose- doors 1-5/8" to 2-1/4" thick- Avail.w/24,25,26,28,29,30,36,37,38,39,40,41,43,45,50,51,52,57,58,67 functions | \$62.00 |
| 60 | SARGENT Large Format Interchangeable Plastic Disposable Construction Core | No addition |
| 63 | SARGENT Large Format Interchangeable core cylinder, includes master keying charges | \$77.00 / cyl |
| 64 | SARGENT Large Format Interchangeable Construction Core Cylinder | \$77.00 |
| 6573▲† | Small Format 6-Pin Uncombined Core (Refer to CK-12) | \$59.00 / cyl. |
| 65737P▲† | Small Format 7-Pin Uncombined Core (Refer to CK-12) | \$59.00 / cyl. |
| 68 | 8200 Line furnished with lever handle outside x knob inside (Excludes SLD Detention Knob) | Defaults to 8200 Lever Lock Price |
| 69 | 8200 Line furnished with lever handle inside x knob outside (Excludes SLD Detention Knob) | Defaults to 8200 Lever Lock Price |
| 70▲† | Small Format interchangeable disposable plastic construction core | No addition |
| 72▲† | Small Format interchangeable 6-Pin construction core | \$69.00 |
| 73▲† | Small Format interchangeable core 6-pin Includes MK and GMK keying charges | \$69.00 / cyl |
| 737P▲† | Small Format interchangeable core 7-pin (refer to CK-12 for available keyways) Includes MK and GMK keying charges | \$69.00 / cyl |
| 74 | Lock case wrapped in lead - handing required (roses not available) | \$272.00 |
| 75 | Tactile Warning - Milled Inside Lever | \$72.00 |
| 76 | Tactile Warning - Milled Outside Lever | \$72.00 |
| 77 | Tactile Warning - Milled Outside and Inside Lever | \$144.00 |
| 81▲† | Cylinder to accept Keso (83) and Keso F1 (F183) removable core - no core provided | No addition |
| F182† | SARGENT Keso Security Cylinder - patented - new key systems | \$84.00 / cyl. |
| F183▲† | SARGENT Keso Security Removable Core Cylinder - patented - new key systems | \$120.00 / cyl. |
| 82† | SARGENT Keso Security Cylinder (For existing systems only) | \$84.00 / cyl. |
| 83▲† | SARGENT Keso Security Removable Core Cylinder (For existing systems only) | \$120.00 / cyl. |
| 84▲† | SARGENT Keso Security Removable Construction Core Cylinder | See CK-18 |
| 85 | Tactile Warning - Abrasive Coating on Inside Lever | \$45.00 |
| 86 | Tactile Warning - Abrasive Coating on Outside Lever | \$45.00 |
| 87 | Tactile Warning - Abrasive Coating on Outside & Inside Lever | \$90.00 |
| AV | Anti Vandal Pull Trim (available in 32D finish), (Not available with 8270, 8271, 8272, 8273 functions) | \$212.00 |
| BR | SARGENT Bump Resistant Cylinders (N/A w/10, 22, 30, 60, 63, 64, 70, 72, 73, 737P, KESO, SC, & SE options) | \$23.00 /cyl. |
| DG1 | Patented Degree DG1 Key System | No Addition |
| DG160 | Hardware prepared for DG1-6300 Lg. Format IC cores, supplied with temporary plastic construction cores | No addition |
| DG163 | Patented Degree DG1 Large Format Interchangeable Core Cylinder - Includes master keying charges | \$77.00 |
| DG164 | Hardware prepared for DG1-6300 Lg. Format IC cores, supplied with temporary keyed construction cores | \$77.00 |
| DG2 | Patented Degree DG2 Key System incorporating a locking sidebar | \$58.00/cyl. |
| DG260 | Hardware prepared for DG2-6300 Lg. Format IC cores, supplied with temporary plastic construction cores | No addition |
| DG263 | Patented Degree DG2 Large Format Interchangeable Core Cylinder - Includes master keying charges | \$135.00 |
| DG264 | Hardware prepared for DG2-6300 Lg. Format IC cores, supplied with temporary keyed construction cores | \$77.00 |
| DG3 | Patented Degree DG3 Key System incorporating a locking sidebar and UL437 listed | \$82.00/cyl. |
| DG360 | Hardware prepared for DG3-6300 Lg. Format IC cores, supplied with temporary plastic construction cores | No addition |
| DG363 | Patented Degree DG3 Large Format Interchangeable Core Cylinder - Includes master keying charges | \$159.00 |
| DG364 | Hardware prepared for DG3-6300 Lg. Format IC cores, supplied with temporary keyed construction cores | \$77.00 |
| IDP | Integrated Door Position Switch | \$100.00 |
| LB | Extra large thumbturn | \$16.00 |
| LC | Less Cylinder | -\$89.00/cyl. |
| OBS | Open Back Strike | \$73.00 |
| PHR | Deadbolt Privacy Function (available w/deadbolt function only) | \$100.00 |
| R01 | Mercury and Lenel compatible 1KΩ/2KΩ resistance supervision | \$100.00 |
| R03 | Software House compatible 1KΩ/2KΩ resistance supervision | \$100.00 |
| R04 | AMAG compatible 4-state supervision | \$100.00 |
| SC▲† | Schlage "C" Keyway cylinder, (Number 41 Cylinder Only, 0 bitted) | No addition |
| SE▲† | Schlage "E" Keyway cylinder, (Number 41 Cylinder Only, 0 bitted) | No addition |
| SG | MicroShield® - an antimicrobial powder coat finish | \$67.00 |
| WBS | Wrought Box Strike | No addition |

NOTES: ▲ Options not avail. with a standard 50 function lockout cylinder. † Not avail. with 60, 63, 64 options

CPC Clear Powder Coat over 26D/32D - NAC-82271-12V x LNA x RH x 32D x CPC \$62.00
All orders will continue to be handled as a "special" when CPC is ordered.

USA & Canada
Prices Effective
June 3, 2019



Rose: O, E, L, LN (Shown) Levers: A, E, F, W (All Shown)

| NAC 8200 Electrified Mortise Locks with High Security Monitoring | | | | 10BE/26D/ BSP/WSP | 03/04/09/10/ 10B/10BL/14/15/ 20D/26/32/32D |
|--|----------------|------------------------|--------------------------------------|----------------------|--|
| Option | Function | Trim - Proximity Entry | Description | | |
| NAC | 82270-12V/-24V | Rose x Lever Design | Fail Safe w/Cylinder Override | \$1,377.00 | \$1,401.00 |
| NAC | 82271-12V/-24V | Rose x Lever Design | Fail Secure w/Cylinder Override | | |
| NAC | 82280-12V/-24V | Rose x Lever Design | Fail Safe w/Deadbolt w/Cyl.Override | \$1,452.00 | \$1,476.00 |
| NAC | 82281-12V/-24V | Rose x Lever Design | Fail Secure w/D.bolt w/Cyl.Override | | |
| NAC | 82274-12V/-24V | Rose x Lever Design | Fail Safe - No Cylinder | \$1,322.00 | \$1,346.00 |
| NAC | 82275-12V/-24V | Rose x Lever Design | Fail Secure - No Cylinder | | |
| NAC | 82284-12V/-24V | Rose x Lever Design | Fail Safe w/Deadbolt - No Cylinder | \$1,397.00 | \$1,421.00 |
| NAC | 82285-12V/-24V | Rose x Lever Design | Fail Secure w/Deadbolt - No Cylinder | | |

Note: Consult catalog for ordering information.
Specify hand and voltage (12v or 24v) when ordering.

ML-6 MORTISE LOCKS

SARGENT®

ASSA ABLOY

OPTIONS

USA & Canada Prices Effective June 3, 2019

| Options | Description | Price |
|----------|--|--|
| 1▲ | 8200 Line with 1-1/16" wide front for 1-3/8" doors. | \$58.00 |
| 3 | Stainless steel hub (not available with 8289, 8291 & 8292 functions) | \$63.00 |
| 10▲ | SARGENT Signature Key System | \$58.00 / cyl. |
| 11†▲ | SARGENT XC Key System (not available with 10, 22, SC, SE options) | No addition |
| 1160 | SARGENT XC Large Format Interchangeable Plastic Disposable Construction Core | No addition |
| 1163 | SARGENT XC Large Format Interchangeable Core Cylinder - Includes masterkeying charges | \$77.00 |
| 1164 | SARGENT XC Large Format Interchangeable Construction Core Cylinder | \$77.00 |
| 1170 | Small Format interchangeable disposable construction core - to accept 7 Pin XC permanent core | No addition |
| 11727P | Small Format interchangeable keyed construction core - to accept 7 Pin XC permanent core | \$69.00 |
| 11737P | Small Format interchangeable core - to accept 7 pin XC permanent core | \$69.00 / cyl. |
| 21▲† | SARGENT Construction Key System (lost ball) Standard on all new systems established since 5/1/96 | \$16.00 / cyl. |
| 22▲† | SARGENT Construction Key System (split key) To be used on pre-established split key systems only | \$32.00 / cyl. |
| 23 | Locksets with flat 4 7/8" ANSI strike | No addition |
| 31 | Thick Doors - Extended Lip Required - Specify Length C to E - Cylinders - IMPORTANT- See catalog 7800/8200 option page for cylinder limitations - Below charges DO NOT include additional charges for special cylinder requirements Doors up to 2-1/2" thick - lock centered Doors 2-5/8" to 6" thick OR doors 1-3/4" thick w/max 1" paneling one side. For example: Specify 1-3/4" door with panel (Side) on inside or outside | No addition Non Keyed function \$50.00 Keyed function \$100.00 |
| 36 | 6 Lobe security head screws | \$23.00 |
| 37 | Spanner head screws | \$16.00 |
| 49 | Visual Status Indicator - Available with 30, 36, 37 function - Rose Trims 7800 CR, E, L, LN, O, TR - Available with 26, 29, 38, 39 40, 41 functions - Rose Trim 8200 LN | \$92.00 |
| 49 | Occupancy Indicator with emergency Release - Available with 65, 66, 68 functions; Rose Trims 7800 CR, E, L, LN, O, TR | \$92.00 |
| 50 | Secured Indicator Rose- doors 1-5/8" to 2-1/4" thick- Avail.w/24,25,26,28,29,30,36,37,38,39,40,41,43,45,50,51,52,57,58,67 functions | \$62.00 |
| 60 | SARGENT Large Format Interchangeable Plastic Disposable Construction Core | No addition |
| 63 | SARGENT Large Format Interchangeable core cylinder, includes master keying charges | \$77.00 / cyl. |
| 64 | SARGENT Large Format Interchangeable Construction Core Cylinder | \$77.00 |
| 6573▲† | Small Format 6-Pin Uncombined Core (Refer to CK-12) | \$59.00 / cyl. |
| 65737P▲† | Small Format 7-Pin Uncombined Core (Refer to CK-12) | \$59.00 / cyl. |
| 68 | 8200 Line furnished with lever handle outside x knob inside (Excludes SLD Detention Knob) | Defaults to 8200 Lever Lock Price |
| 69 | 8200 Line furnished with lever handle inside x knob outside (Excludes SLD Detention Knob) | Defaults to 8200 Lever Lock Price |
| 70▲† | Small Format Interchangeable disposable plastic construction core | No addition |
| 72▲† | Small Format Interchangeable 6-pin construction core (7-pin with 11 option) | \$69.00 |
| 73▲† | Small Format 6-pin interchangeable core (refer to CK-8 for available keyways) | \$69.00 / cyl |
| 737P▲† | Small Format 7-pin interchangeable core (refer to CK-8 for available keyways) | \$69.00 / cyl |
| 74 | Lock case wrapped in lead - handing required (roses not available) | \$272.00 |
| 75 | Tactile Warning - Milled Inside Lever | \$72.00 |
| 76 | Tactile Warning - Milled Outside Lever | \$72.00 |
| 77 | Tactile Warning - Milled Outside and Inside Lever | \$144.00 |
| 81▲† | Cylinder to accept Keso (83) and Keso F1 (F183) removable core - no core provided | No addition |
| F182† | SARGENT Keso Security Cylinder - patented - new key systems | \$84.00 / cyl. |
| F183▲† | SARGENT Keso Security Removable Core Cylinder - patented - new key systems | \$120.00 / cyl. |
| 82† | SARGENT Keso Security Cylinder (For existing systems only) | \$84.00 / cyl. |
| 83▲† | SARGENT Keso Security Removable Core Cylinder (For existing systems only) | \$120.00 / cyl. |
| 84▲† | SARGENT Keso Security Removable Construction Core Cylinder | See CK-18 |
| 85 | Tactile Warning - Abrasive Coating on Inside Lever | \$45.00 |
| 86 | Tactile Warning - Abrasive Coating on Outside Lever | \$45.00 |
| 87 | Tactile Warning - Abrasive Coating on Outside & Inside Lever | \$90.00 |
| AV | Anti Vandal Pull Trim (available in 32D finish), (Not available with 8270, 8271, 8272, 8273 functions) | \$212.00 |
| BR | SARGENT Bump Resistant Cylinders (N/A w/10, 22, 30, 60, 63, 64, 70, 72, 73, 737P, KESO, SC, & SE options) | \$23.00 /cyl. |
| DG1 | Patented Degree DG1 Key System | No Addition |
| DG160 | Hardware prepared for DG1-6300 Lg. Format IC cores, supplied with temporary plastic construction cores | No addition |
| DG163 | Patented Degree DG1 Large Format Interchangeable Core Cylinder - Includes master keying charges | \$77.00 |
| DG164 | Hardware prepared for DG1-6300 Lg. Format IC cores, supplied with temporary keyed construction cores | \$77.00 |
| DG2 | Patented Degree DG2 Key System incorporating a locking sidebar | \$58.00/cyl. |
| DG260 | Hardware prepared for DG2-6300 Lg. Format IC cores, supplied with temporary plastic construction cores | No addition |
| DG263 | Patented Degree DG2 Large Format Interchangeable Core Cylinder - Includes master keying charges | \$135.00 |
| DG264 | Hardware prepared for DG2-6300 Lg. Format IC cores, supplied with temporary keyed construction cores | \$77.00 |
| DG3 | Patented Degree DG3 Key System incorporating a locking sidebar and UL437 listed | \$82.00/cyl. |
| DG360 | Hardware prepared for DG3-6300 Lg. Format IC cores, supplied with temporary plastic construction cores | No addition |
| DG363 | Patented Degree DG3 Large Format Interchangeable Core Cylinder - Includes master keying charges | \$159.00 |
| DG364 | Hardware prepared for DG3-6300 Lg. Format IC cores, supplied with temporary keyed construction cores | \$77.00 outside |
| DX | Deadbolt Monitoring (not available with 50, 74) | \$182.00 |
| LB | Extra large thumbturn | \$16.00 |
| LC | Less Cylinder | -\$89.00/cyl. |
| LX | Latchbolt Monitor - available with all non-deadbolt functions; not available with DX option | \$185.00 |
| OBS | Open Back Strike | \$73.00 |
| RX | Request to Exit | \$190.00 |
| SC▲† | Schlage "C" Keyway cylinder, (Number 41 Cylinder Only, 0 bitted) | No addition |
| SE▲† | Schlage "E" Keyway cylinder, (Number 41 Cylinder Only, 0 bitted) | No addition |
| SG | MicroShield® - an antimicrobial powder coat finish | \$67.00 |
| WBS | Wrought Box Strike | No addition |

NOTES: ▲ Options not avail. with a standard 50 function lockout cylinder. † Not avail. with 60, 63, 64 options

| | | |
|-----|---|---------|
| CPC | Clear Powder Coat over 26D/32D - 8205 x LNL x 32D x CPC All orders will continue to be handled as a "special" when CPC is ordered. | \$62.00 |
|-----|---|---------|

ASSA ABLOY

8200



LNB



LNL



LNP

USA & Canada
Prices Effective
June 3, 2019

Rose: O, E, L, LN (Shown) Levers: B, L, P (All shown)

| Function | | Finish | |
|---|------------------------------------|------------------|--|
| | | 10BE/26D/BSP/WSP | 03/04/09/10/10B/10BL/14/15/20D/26/32/32D |
| Single Cyl | | | |
| 8204 | Storeroom or Closet | | |
| 8205 | Office or Entry | | |
| 8237 | Classroom | \$979.00 | \$1,003.00 |
| 8255 | Office or Entry | | |
| <hr/> | | | |
| 8206 | Storeroom or Service | | |
| 8231 | Utility | | |
| 8236 | Closet | | |
| 8256 | Office or Inner Entry | \$996.00 | \$1,020.00 |
| 8257, 8258, 8267 | Institutional Privacy | | |
| 8289 | Holdback | | |
| 8291 | All Purpose Holdback | | |
| <hr/> | | | |
| Single Cyl With Deadbolt | | | |
| 8224 | Room Door | | |
| 8225 | Dormitory or Exit | | |
| 8227 | Closet or Storeroom | | |
| 8228, 8230 | Dummy Trim Deadlock | | |
| 8235 | Storeroom | \$1,025.00 | \$1,049.00 |
| 8243 | Apartment Corridor | | |
| 8245 | Dormitory or Exit | | |
| 8247 | Front Door or Apartment Corridor | | |
| 8251 | Storeroom Deadbolt | | |
| 8250 | Hotel Guest Lock | \$1,066.00 | \$1,090.00 |
| <hr/> | | | |
| Double Cyl No Deadbolt | | | |
| 8216 | Apartment or Exit or Public Toilet | | |
| 8217 | Asylum or Institutional | | |
| 8238 | Classroom Security Intruder | \$1,077.00 | \$1,101.00 |
| 8259 | School Security | | |
| 8290 | Classroom Security Holdback | | |
| 8292 | All Purpose Holdback | | |
| <hr/> | | | |
| Double Cyl With Deadbolt | | | |
| 8226 | Store Door | | |
| 8229 | Dummy Trim Deadlock | | |
| 8239, 8240 | Classroom Security Intruder | | |
| 8241 | Classroom Security | \$1,088.00 | \$1,112.00 |
| 8246 | Dormitory or Exit | | |
| 8248 | Store Door | | |
| 8249 | Security Deadbolt | | |
| 8252 | Institutional | | |
| <hr/> | | | |
| Electro Mechanical Single Cyl – Specify 12V or 24V | | | |
| 8270-12V / 8270-24V | Fail Safe | \$1,175.00 | \$1,199.00 |
| 8271-12V / 8271-24V | Fail Secure | | |
| <hr/> | | | |
| Electro Mechanical Double Cyl – Specify 12V or 24V | | | |
| 8272-12V / 8272-24V | Fail Safe | \$1,232.00 | \$1,256.00 |
| 8273-12V / 8273-24V | Fail Secure | | |
| <hr/> | | | |
| Non Keyed | | | |
| 8213 | Communication or Exit | \$773.00 | \$797.00 |
| 8215 | Passage or Closet | | |
| 8265 | Privacy Bedroom or Bath (Latch) | \$873.00 | \$897.00 |
| 8266, 8268 | Privacy Bedroom or Bath (Deadbolt) | \$954.00 | \$978.00 |
| 8293 | Single Dummy Trim | \$315.00 | \$327.00 |
| 8294 | Double Dummy Trim | \$635.00 | \$659.00 |
| 8295 | Single Dummy Trim w/Lockbody | \$413.00 | \$425.00 |
| 8296 | Double Dummy Trim w/Lockbody | \$730.00 | \$754.00 |
| 8297 | Double Dummy w/Active Trim | \$812.00 | \$836.00 |

ML-8 MORTISE LOCKS

SARGENT®

ASSA ABLOY

OPTIONS

USA & Canada Prices Effective June 3, 2019

| Options | Description | Price |
|----------|--|---|
| 1▲ | 8200 Line with 1-1/16" wide front for 1-3/8" doors. | \$58.00 |
| 3 | Stainless steel hub (not available with 8289, 8291 & 8292 functions) | \$63.00 |
| 10▲ | SARGENT Signature Key System | \$58.00 / cyl. |
| 11†▲ | SARGENT XC Key System (not available w/10, KESO, SC, SE) | No addition |
| 1160 | SARGENT XC Large Format Interchangeable Plastic Disposable Construction Core | No addition |
| 1163 | SARGENT XC Large Format Interchangeable Core Cylinder - Includes masterkeying charges | \$77.00 |
| 1164 | SARGENT XC Large Format Interchangeable Construction Core Cylinder | \$77.00 |
| 1170 | Small Format interchangeable disposable construction core - to accept 7 Pin XC permanent core | No addition |
| 11727P | Small Format interchangeable keyed construction core - to accept 7 Pin XC permanent core | \$69.00 |
| 11737P | Small Format interchangeable core - to accept 7 pin XC permanent core | \$69.00 /cyl. |
| 21▲† | SARGENT Construction Key System (lost ball) Standard on all new systems established since 5/1/96 | \$16.00 / cyl. |
| 22▲† | SARGENT Construction Key System (split key) To be used on pre-established split key systems only | \$32.00 / cyl. |
| 23 | Locksets with flat 4 7/8" ANSI strike | No addition |
| 31 | Thick Doors - Extended Lip Required - Specify Length C to E IMPORTANT: See 7800/8200 Catalog Option Page for Cylinder Limits – DOES NOT include additional Charges for Special Cylinder Requirements | No addition |
| | Doors up to 2-1/2" thick - lock centered • Doors 2-5/8" to 6" thick OR doors 1-3/4" thick w/max 1" paneling one side. For example: Specify 1-3/4" door with panel (Side) on inside or outside | Non Keyed function \$50.00 Keyed function \$100.00 |
| 36 | 6 Lobe security head screws | \$23.00 |
| 37 | Spanner head screws | \$16.00 |
| 49 | Visual Status Indicator – Available with 30, 36, 37 function – Rose Trims CR, E, L, LN, O, TR – Available with 26, 29, 38, 39 40, 41 functions – Rose Trim 8200 LN | \$92.00 |
| 49 | Occupancy Indicator with emergency Release – Available with 65, 66, 68 functions; Rose Trims 7800 CR, E, L, LN, O, TR | \$92.00 |
| 50 | Secured Indicator Rose– doors 1-5/8" to 2-1/4" thick– Avail.w/24,25,26,28,29,30,36,37,38,39,40,41,43,45,50,51,52,57,58,67 functions | \$62.00 |
| 60 | SARGENT Large Format Interchangeable Plastic Disposable Construction Core | No addition |
| 63 | SARGENT Large Format Interchangeable core cylinder, includes master keying charges | \$77.00 / cyl |
| 64 | SARGENT Large Format Interchangeable Construction Core Cylinder | \$77.00 |
| 6573▲† | Small Format 6-Pin Uncombined Core (Refer to CK-12) | \$59.00 / cyl. |
| 65737P▲† | Small Format 7-Pin Uncombined Core (Refer to CK-12) | \$59.00 / cyl. |
| 68 | 8200 Line furnished with lever handle outside x knob inside (Excludes SLD Detention Knob) | Defaults to 8200 Lever Lock Price |
| 69 | 8200 Line furnished with lever handle inside x knob outside (Excludes SLD Detention Knob) | Defaults to 8200 Lever Lock Price |
| 70▲† | Small Format interchangeable disposable plastic construction core | No addition |
| 72▲† | Small Format interchangeable 6-Pin construction core | \$69.00 |
| 73▲† | Small Format interchangeable core 6-pin Includes MK and GMK keying charges | \$69.00 / cyl |
| 737P▲† | Small Format interchangeable core 7-pin (refer to CK-12 for available keyways) Includes MK and GMK keying charges | \$69.00 / cyl |
| 74 | Lock case wrapped in lead – handing required (roses not available) | \$272.00 |
| 75 | Tactile Warning - Milled Inside Lever | \$72.00 |
| 76 | Tactile Warning - Milled Outside Lever | \$72.00 |
| 77 | Tactile Warning - Milled Outside and Inside Lever | \$144.00 |
| 81▲† | Cylinder to accept Keso (83) and Keso F1 (F183) removable core – no core provided | No addition |
| F182† | SARGENT Keso Security Cylinder – patented – new key systems | \$84.00 / cyl. |
| F183▲† | SARGENT Keso Security Removable Core Cylinder – patented – new key systems | \$120.00 / cyl. |
| 82† | SARGENT Keso Security Cylinder (For existing systems only) | \$84.00 / cyl. |
| 83▲† | SARGENT Keso Security Removable Core Cylinder (For existing systems only) | \$120.00 / cyl. |
| 84▲† | SARGENT Keso Security Removable Construction Core Cylinder | See CK-18 |
| 85 | Tactile Warning - Abrasive Coating on Inside Lever | \$45.00 |
| 86 | Tactile Warning - Abrasive Coating on Outside Lever | \$45.00 |
| 87 | Tactile Warning - Abrasive Coating on Outside & Inside Lever | \$90.00 |
| AV | Anti Vandal Pull Trim (available in 32D finish) (Not available with 8270, 8271, 8272, 8273 functions) | \$212.00 |
| BR | SARGENT Bump Resistant Cylinders (N/A w/10, 22, 30, 60, 63, 64, 70, 72, 73, 737P, KESO, SC, & SE options) | \$23.00 /cyl. |
| DG1 | Patented Degree DG1 Key System | No Addition |
| DG160 | Hardware prepared for DG1-6300 Lg. Format IC cores, supplied with temporary plastic construction cores | No addition |
| DG163 | Patented Degree DG1 Large Format Interchangeable Core Cylinder - Includes master keying charges | \$77.00 |
| DG164 | Hardware prepared for DG1-6300 Lg. Format IC cores, supplied with temporary keyed construction cores | \$77.00 |
| DG2 | Patented Degree DG2 Key System incorporating a locking sidebar | \$58.00/cyl. |
| DG260 | Hardware prepared for DG2-6300 Lg. Format IC cores, supplied with temporary plastic construction cores | No addition |
| DG263 | Patented Degree DG2 Large Format Interchangeable Core Cylinder - Includes master keying charges | \$135.00 |
| DG264 | Hardware prepared for DG2-6300 Lg. Format IC cores, supplied with temporary keyed construction cores | \$77.00 |
| DG3 | Patented Degree DG3 Key System incorporating a locking sidebar and UL437 listed | \$82.00/cyl. |
| DG360 | Hardware prepared for DG3-6300 Lg. Format IC cores, supplied with temporary plastic construction cores | No addition |
| DG363 | Patented Degree DG3 Large Format Interchangeable Core Cylinder - Includes master keying charges | \$159.00 |
| DG364 | Hardware prepared for DG3-6300 Lg. Format IC cores, supplied with temporary keyed construction cores | \$77.00 |
| IDP | Integrated Door Position Switch | \$100.00 |
| LB | Extra large thumbturn | \$16.00 |
| LC | Less Cylinder | -\$89.00/cyl. |
| OBS | Open Back Strike | \$73.00 |
| PHR | Deadbolt Privacy Function (available w/deadbolt function only) | \$100.00 |
| R01 | Mercury and Lenel compatible 1KΩ/2KΩ resistance supervision | \$100.00 |
| R03 | Software House compatible 1KΩ/2KΩ resistance supervision | \$100.00 |
| R04 | AMAG compatible 4-state supervision | \$100.00 |
| SC▲† | Schlage "C" Keyway cylinder, (Number 41 Cylinder Only, 0 bitted) | No addition |
| SE▲† | Schlage "E" Keyway cylinder, (Number 41 Cylinder Only, 0 bitted) | No addition |
| SG | MicroShield® – an antimicrobial powder coat finish | \$67.00 |
| WBS | Wrought Box Strike | No addition |

NOTES: ▲ Options not avail. with a standard 50 function lockout cylinder. † Not avail. with 60, 63, 64 options
CPC Clear Powder Coat over 26D/32D – NAC 82271-12V x LNA x HH x 32D x CPC \$62.00
All orders will continue to be handled as a "special" when CPC is ordered.

USA & Canada Prices Effective June 3, 2019



LNB



LNL



LNP

Rose: O, E, L, LN (Shown) Levers: B, L, P (All shown)

| NAC 8200 Electrified Mortise Locks with High Security Monitoring | | | | 10BE/26D/ BSP/WSP | 03/04/09/10/ 10B/10BL/14/15/ 20D/26/32/32D |
|--|----------------|------------------------|--------------------------------------|----------------------|--|
| Option | Function | Trim - Proximity Entry | Description | | |
| NAC | 82270-12V/-24V | Rose x Lever Design | Fail Safe w/Cylinder Override | \$1,350.00 | \$1,374.00 |
| NAC | 82271-12V/-24V | Rose x Lever Design | Fail Secure w/Cylinder Override | | |
| NAC | 82280-12V/-24V | Rose x Lever Design | Fail Safe w/Deadbolt w/Cyl.Override | \$1,425.00 | \$1,449.00 |
| NAC | 82281-12V/-24V | Rose x Lever Design | Fail Secure w/D.bolt w/Cyl.Override | | |
| NAC | 82274-12V/-24V | Rose x Lever Design | Fail Safe - No Cylinder | \$1,295.00 | \$1,319.00 |
| NAC | 82275-12V/-24V | Rose x Lever Design | Fail Secure - No Cylinder | | |
| NAC | 82284-12V/-24V | Rose x Lever Design | Fail Safe w/Deadbolt - No Cylinder | \$1,370.00 | \$1,394.00 |
| NAC | 82285-12V/-24V | Rose x Lever Design | Fail Secure w/Deadbolt - No Cylinder | | |

Note: Consult catalog for ordering information.

Specify hand and voltage (12v or 24v) when ordering

ML-10 MORTISE LOCKS

SARGENT®

ASSA ABLOY

OPTIONS

USA & Canada Prices Effective June 3, 2019

| Options | Description | Price |
|----------|--|---|
| 1▲ | 8200 Line with 1-1/16" wide front for 1-3/8" doors. | \$58.00 |
| 3 | Stainless steel hub (not available with 8289, 8291 & 8292 functions) | \$63.00 |
| 10▲ | SARGENT Signature Key System | \$58.00 / cyl. |
| 11†▲ | SARGENT XC Key System (not available with 10, 22, SC, SE options) | No addition |
| 1160 | SARGENT XC Large Format Interchangeable Plastic Disposable Construction Core | No addition |
| 1163 | SARGENT XC Large Format Interchangeable Core Cylinder - Includes masterkeying charges | \$77.00 |
| 1164 | SARGENT XC Large Format Interchangeable Construction Core Cylinder | \$77.00 |
| 1170 | Small Format interchangeable disposable construction core - to accept 7 Pin XC permanent core | No addition |
| 11727P | Small Format interchangeable keyed construction core - to accept 7 Pin XC permanent core | \$69.00 |
| 11737P | Small Format interchangeable core - to accept 7 pin XC permanent core | \$69.00 / cyl. |
| 21▲† | SARGENT Construction Key System (lost ball) Standard on all new systems established since 5/1/96 | \$16.00 / cyl. |
| 22▲† | SARGENT Construction Key System (split key) To be used on pre-established split key systems only | \$32.00 / cyl. |
| 23 | Locksets with flat 4 7/8" ANSI strike | No addition |
| 31 | Thick Doors - Extended Lip Required - Specify Length C to E - Cylinders - IMPORTANT- See catalog 7800/8200 option page for cylinder limitations - Below charges DO NOT include additional charges for special cylinder requirements Doors up to 2-1/2" thick - lock centered Doors 2-5/8" to 6" thick OR doors 1-3/4" thick w/max 1" paneling one side. For example: Specify 1-3/4" door with panel (Side) on inside or outside | No addition Non Keyed function \$50.00 Keyed function \$100.00 |
| 36 | 6 Lobe security head screws | \$23.00 |
| 37 | Spanner head screws | \$16.00 |
| 49 | Visual Status Indicator - Available with 30, 36, 37 function - Rose Trims CR, E, L, LN, O, TR - Available with 26, 29, 38, 39 40, 41 functions - Rose Trim 8200 LN | \$92.00 |
| 49 | Occupancy Indicator with emergency Release - Available with 65, 66, 68 functions; Rose Trims 7800 CR, E, L, LN, O, TR | \$92.00 |
| 50 | Secured Indicator Rose- doors 1-5/8" to 2-1/4" thick- Avail.w/24,25,26,28,29,30,36,37,38,39,40,41,43,45,50,51,52,57,58,67 functions | \$62.00 |
| 60 | SARGENT Large Format Interchangeable Plastic Disposable Construction Core | No addition |
| 63 | SARGENT Large Format Interchangeable core cylinder, includes master keying charges | \$77.00 / cyl. |
| 64 | SARGENT Large Format Interchangeable Construction Core Cylinder | \$77.00 |
| 6573▲† | Small Format 6-Pin Uncombined Core (Refer to CK-12) | \$59.00 / cyl. |
| 65737P▲† | Small Format 7-Pin Uncombined Core (Refer to CK-12) | \$59.00 / cyl. |
| 68 | 8200 Line furnished with lever handle outside x knob inside (Excludes SLD Detention Knob) | Defaults to 8200 Lever Lock Price |
| 69 | 8200 Line furnished with lever handle inside x knob inside (Excludes SLD Detention Knob) | Defaults to 8200 Lever Lock Price |
| 70▲† | Small Format interchangeable disposable plastic construction core | No addition |
| 72▲† | Small Format interchangeable 6-pin construction core (7-pin with 11 option) | \$69.00 |
| 73▲† | Small Format interchangeable core 6-pin Includes MK and GMK keying charges | \$69.00 / cyl |
| 737P▲† | Small Format interchangeable core 7-pin (refer to CK-12 for available keyways) Includes MK and GMK keying charges | \$69.00 cyl |
| 74 | Lock case wrapped in lead - handing required (roses not available) | \$272.00 |
| 75 | Tactile Warning - Milled Inside Lever | \$72.00 |
| 76 | Tactile Warning - Milled Outside Lever | \$72.00 |
| 77 | Tactile Warning - Milled Outside and Inside Lever | \$144.00 |
| 81▲† | Cylinder to accept Keso (83) and Keso F1 (F183) removable core - no core provided | No addition |
| F182† | SARGENT Keso Security Cylinder - patented - new key systems | \$84.00 cyl. |
| F183▲† | SARGENT Keso Security Removable Core Cylinder - patented - new key systems | \$120.00 / cyl. |
| 82† | SARGENT Keso Security Cylinder (For existing systems only) | \$84.00 / cyl. |
| 83▲† | SARGENT Keso Security Removable Core Cylinder (For existing systems only) | \$120.00 / cyl. |
| 84▲† | SARGENT Keso Security Removable Construction Core Cylinder | See CK-18 |
| 85 | Tactile Warning - Abrasive Coating on Inside Lever | \$45.00 |
| 86 | Tactile Warning - Abrasive Coating on Outside Lever | \$45.00 |
| 87 | Tactile Warning - Abrasive Coating on Outside & Inside Lever | \$90.00 |
| AV | Anti Vandal Pull Trim (available in 32D finish), (Not available with 8270, 8271, 8272, 8273 functions) | \$212.00 |
| BR | SARGENT Bump Resistant Cylinders (N/A w/10, 22, 30, 60, 63, 64, 70, 72, 73, 737P, KESO, SC, & SE options) | \$23.00 /cyl. |
| DG1 | Patented Degree DG1 Key System | No Addition |
| DG160 | Hardware prepared for DG1-6300 Lg. Format IC cores, supplied with temporary plastic construction cores | No addition |
| DG163 | Patented Degree DG1 Large Format Interchangeable Core Cylinder - Includes master keying charges | \$77.00 |
| DG164 | Hardware prepared for DG1-6300 Lg. Format IC cores, supplied with temporary keyed construction cores | \$77.00 |
| DG2 | Patented Degree DG2 Key System incorporating a locking sidebar | \$58.00/cyl. |
| DG260 | Hardware prepared for DG2-6300 Lg. Format IC cores, supplied with temporary plastic construction cores | No addition |
| DG263 | Patented Degree DG2 Large Format Interchangeable Core Cylinder - Includes master keying charges | \$135.00 |
| DG264 | Hardware prepared for DG2-6300 Lg. Format IC cores, supplied with temporary keyed construction cores | \$77.00 |
| DG3 | Patented Degree DG3 Key System incorporating a locking sidebar and UL437 listed | \$82.00/cyl. |
| DG360 | Hardware prepared for DG3-6300 Lg. Format IC cores, supplied with temporary plastic construction cores | No addition |
| DG363 | Patented Degree DG3 Large Format Interchangeable Core Cylinder - Includes master keying charges | \$159.00 |
| DG364 | Hardware prepared for DG3-6300 Lg. Format IC cores, supplied with temporary keyed construction cores | \$77.00 |
| DX | Deadbolt Monitoring (not available with 50, 74) | \$182.00 |
| LB | Extra large thumbturn | \$16.00 |
| LC | Less Cylinder | -\$89.00/cyl. |
| LX | Latchbolt Monitor - available with all non-deadbolt functions; not available with DX option | \$185.00 |
| OBS | Open Back Strike | \$73.00 |
| RX | Request to Exit | \$190.00 |
| SC▲† | Schlage "C" Keyway cylinder, (Number 41 Cylinder Only, 0 bitted) | No addition |
| SE▲† | Schlage "E" Keyway cylinder, (Number 41 Cylinder Only, 0 bitted) | No addition |
| SG | MicroShield® - an antimicrobial powder coat finish | \$67.00 |
| WBS | Wrought Box Strike | No addition |

NOTES: ▲ Options not avail. with a standard 50 function lockout cylinder. † Not avail. with 60, 63, 64 options

| | | |
|-----|---|---------|
| CPC | Clear Powder Coat over 26D/32D - 8205 x LNj x 32D x CPC All orders will continue to be handled as a "special" when CPC is ordered. | \$62.00 |
|-----|---|---------|



LNJ

USA & Canada Prices Effective June 3, 2019

Rose: O, E, L, LN (Shown) Lever: J (Shown)

| Function | | Finish | |
|---|------------------------------------|------------------|--|
| | | 10BE/26D/BSP/WSP | 03/04/09/10/10B/10BL/14/15/20D/26/32/32D |
| Single Cyl | | | |
| 8204 | Storeroom or Closet | | |
| 8205 | Office or Entry | | |
| 8237 | Classroom | \$851.00 | \$965.00 |
| 8255 | Office or Entry | | |
| <hr/> | | | |
| 8206 | Storeroom or Service | | |
| 8231 | Utility | | |
| 8236 | Closet | | |
| 8256 | Office or Inner Entry | \$868.00 | \$986.00 |
| 8257, 8258, 8267 | Institutional Privacy | | |
| 8289 | Holdback | | |
| 8291 | All Purpose Holdback | | |
| <hr/> | | | |
| Single Cyl With Deadbolt | | | |
| 8224 | Room Door | | |
| 8225 | Dormitory or Exit | | |
| 8227 | Closet or Storeroom | | |
| 8228, 8230 | Dummy Trim Deadlock | | |
| 8235 | Storeroom | \$899.00 | \$1,019.00 |
| 8243 | Apartment Corridor | | |
| 8245 | Dormitory or Exit | | |
| 8247 | Front Door or Apartment Corridor | | |
| 8251 | Storeroom Deadbolt | | |
| 8250 | Hotel Guest Lock | \$937.00 | \$1,063.00 |
| <hr/> | | | |
| Double Cyl No Deadbolt | | | |
| 8216 | Apartment or Exit or Public Toilet | | |
| 8217 | Asylum or Institutional | | |
| 8238 | Classroom Security Intruder | \$953.00 | \$1,075.00 |
| 8259 | School Security | | |
| 8290 | Classroom Security Holdback | | |
| 8292 | All Purpose Holdback | | |
| <hr/> | | | |
| Double Cyl With Deadbolt | | | |
| 8226 | Store Door | | |
| 8229 | Dummy Trim Deadlock | | |
| 8239, 8240 | Classroom Security Intruder | | |
| 8241 | Classroom Security | \$979.00 | \$1,107.00 |
| 8246 | Dormitory or Exit | | |
| 8248 | Store Door | | |
| 8249 | Security Deadbolt | | |
| 8252 | Institutional | | |
| <hr/> | | | |
| Electro Mechanical Single Cyl – Specify 12V or 24V | | | |
| 8270-12V / 8270-24V | Fail Safe | \$1,091.00 | \$1,230.00 |
| 8271-12V / 8271-24V | Fail Secure | | |
| <hr/> | | | |
| Electro Mechanical Double Cyl – Specify 12V or 24V | | | |
| 8272-12V / 8272-24V | Fail Safe | \$1,160.00 | \$1,306.00 |
| 8273-12V / 8273-24V | Fail Secure | | |
| <hr/> | | | |
| Non Keyed | | | |
| 8213 | Communication or Exit | \$646.00 | \$742.00 |
| 8215 | Passage or Closet | | |
| 8265 | Privacy Bedroom or Bath (Latch) | \$749.00 | \$855.00 |
| 8266, 8268 | Privacy Bedroom or Bath (Deadbolt) | \$833.00 | \$945.00 |
| 8293 | Single Dummy Trim | \$243.00 | \$284.00 |
| 8294 | Double Dummy Trim | \$494.00 | \$575.00 |
| 8295 | Single Dummy Trim w/Lockbody | \$346.00 | \$396.00 |
| 8296 | Double Dummy Trim w/Lockbody | \$597.00 | \$688.00 |
| 8297 | Double Dummy w/Active Trim | \$677.00 | \$776.00 |

ML-12 MORTISE LOCKS

SARGENT®

ASSA ABLOY

OPTIONS

USA & Canada Prices Effective June 3, 2019

| Options | Description | Price |
|---|--|---|
| 1▲ | 8200 Line with 1-1/16" wide front for 1-3/8" doors. | \$58.00 |
| 3 | Stainless steel hub (not available with 8289, 8291 & 8292 functions) | \$63.00 |
| 10▲ | SARGENT Signature Key System | \$58.00 / cyl. |
| 11▲ | SARGENT XC Key System (not available w/10, KESO, SC, SE) | No addition |
| 1160 | SARGENT XC Large Format Interchangeable Plastic Disposable Construction Core | No addition |
| 1163 | SARGENT XC Large Format Interchangeable Core Cylinder - Includes masterkeying charges | \$77.00 |
| 1164 | SARGENT XC Large Format Interchangeable Construction Core Cylinder | \$77.00 |
| 1170 | Small Format interchangeable disposable construction core - to accept 7 Pin XC permanent core | No addition |
| 11727P | Small Format interchangeable keyed construction core - to accept 7 Pin XC permanent core | \$69.00 |
| 11737P | Small Format interchangeable core - to accept 7 pin XC permanent core | \$69.00 / cyl. |
| 21▲† | SARGENT Construction Key System (lost ball) Standard on all new systems established since 5/1/96 | \$16.00 / cyl. |
| 22▲† | SARGENT Construction Key System (split key) To be used on pre-established split key systems only | \$32.00 / cyl. |
| 23 | Locksets with flat 4 7/8" ANSI strike | No addition |
| 31 | Thick Doors - Extended Lip Required - Specify Length C to E IMPORTANT: See 7800/8200 Catalog Option Page for Cylinder Limits – DOES NOT include additional Charges for Special Cylinder Requirements | No addition |
| | Doors up to 2-1/2" thick - lock centered • Doors 2-5/8" to 6" thick OR doors 1-3/4" thick w/max 1" paneling one side. For example: Specify 1-3/4" door with panel (Side) on inside or outside | Non Keyed function \$50.00 Keyed function \$100.00 |
| 36 | 6 Lobe security head screws | \$23.00 |
| 37 | Spanner head screws | \$16.00 |
| 49 | Visual Status Indicator – Available with 30, 36, 37 function – Rose Trims CR, E, L, LN, O, TR – Available with 26, 29, 38, 39 40, 41 functions – Rose Trim 8200 LN | \$92.00 |
| 49 | Occupancy Indicator with emergency Release – Available with 65, 66, 68 functions; Rose Trims 7800 CR, E, L, LN, O, TR | \$92.00 |
| 50 | Secured Indicator Rose– doors 1-5/8" to 2-1/4" thick– Avail.w/24,25,26,28,29,30,36,37,38,39,40,41,43,45,50,51,52,57,58,67 functions | \$62.00 |
| 60 | SARGENT Large Format Interchangeable Plastic Disposable Construction Core | No addition |
| 63 | SARGENT Large Format Interchangeable core cylinder, includes master keying charges | \$77.00 / cyl |
| 64 | SARGENT Large Format Interchangeable Construction Core Cylinder | \$77.00 |
| 6573▲† | Small Format 6-Pin Uncombined Core (Refer to CK-12) | \$59.00 / cyl. |
| 65737P▲† | Small Format 7-Pin Uncombined Core (Refer to CK-12) | \$59.00 / cyl. |
| 68 | 8200 Line furnished with lever handle outside x knob inside (Excludes SLD Detention Knob) | Defaults to 8200 Lever Lock Price |
| 69 | 8200 Line furnished with lever handle inside x knob outside (Excludes SLD Detention Knob) | Defaults to 8200 Lever Lock Price |
| 70▲† | Small Format interchangeable disposable plastic construction core | No addition |
| 72▲† | Small Format interchangeable 6-Pin construction core | \$69.00 |
| 73▲† | Small Format interchangeable core 6-pin Includes MK and GMK keying charges | \$69.00 / cyl |
| 737P▲† | Small Format interchangeable core 7-pin (refer to CK-12 for available keyways) Includes MK and GMK keying charges | \$69.00 / cyl |
| 74 | Lock case wrapped in lead – handing required (roses not available) | \$272.00 |
| 75 | Tactile Warning - Milled Inside Lever | \$72.00 |
| 76 | Tactile Warning - Milled Outside Lever | \$72.00 |
| 77 | Tactile Warning - Milled Outside and Inside Lever | \$144.00 |
| 81▲† | Cylinder to accept Keso (83) and Keso F1 (F183) removable core – no core provided | No addition |
| F182† | SARGENT Keso Security Cylinder – patented – new key systems | \$84.00 / cyl. |
| F183▲† | SARGENT Keso Security Removable Core Cylinder – patented – new key systems | \$120.00 / cyl. |
| 82† | SARGENT Keso Security Cylinder (For existing systems only) | \$84.00 / cyl. |
| 83▲† | SARGENT Keso Security Removable Core Cylinder (For existing systems only) | \$120.00 / cyl. |
| 84▲† | SARGENT Keso Security Removable Construction Core Cylinder | See CK-18 |
| 85 | Tactile Warning - Abrasive Coating on Inside Lever | \$45.00 |
| 86 | Tactile Warning - Abrasive Coating on Outside Lever | \$45.00 |
| 87 | Tactile Warning - Abrasive Coating on Outside & Inside Lever | \$90.00 |
| AV | Anti Vandal Pull Trim (available in 32D finish) (Not available with 8270, 8271, 8272, 8273 functions) | \$212.00 |
| BR | SARGENT Bump Resistant Cylinders (N/A w/10, 22, 30, 60, 63, 64, 70, 72, 73, 737P, KESO, SC, & SE options) | \$23.00 /cyl. |
| DG1 | Patented Degree DG1 Key System | No Addition |
| DG160 | Hardware prepared for DG1-6300 Lg. Format IC cores, supplied with temporary plastic construction cores | No addition |
| DG163 | Patented Degree DG1 Large Format Interchangeable Core Cylinder - Includes master keying charges | \$77.00 |
| DG164 | Hardware prepared for DG1-6300 Lg. Format IC cores, supplied with temporary keyed construction cores | \$77.00 |
| DG2 | Patented Degree DG2 Key System incorporating a locking sidebar | \$58.00/cyl. |
| DG260 | Hardware prepared for DG2-6300 Lg. Format IC cores, supplied with temporary plastic construction cores | No addition |
| DG263 | Patented Degree DG2 Large Format Interchangeable Core Cylinder - Includes master keying charges | \$135.00 |
| DG264 | Hardware prepared for DG2-6300 Lg. Format IC cores, supplied with temporary keyed construction cores | \$77.00 |
| DG3 | Patented Degree DG3 Key System incorporating a locking sidebar and UL437 listed | \$82.00/cyl. |
| DG360 | Hardware prepared for DG3-6300 Lg. Format IC cores, supplied with temporary plastic construction cores | No addition |
| DG363 | Patented Degree DG3 Large Format Interchangeable Core Cylinder - Includes master keying charges | \$159.00 |
| DG364 | Hardware prepared for DG3-6300 Lg. Format IC cores, supplied with temporary keyed construction cores | \$77.00 |
| IDP | Integrated Door Position Switch | \$100.00 |
| LB | Extra large thumbturn | \$16.00 |
| LC | Less Cylinder | -\$89.00/cyl. |
| OBS | Open Back Strike | \$73.00 |
| PHR | Deadbolt Privacy Function (available w/deadbolt function only) | \$100.00 |
| R01 | Mercury and Lenel compatible 1KΩ/2KΩ resistance supervision | \$100.00 |
| R03 | Software House compatible 1KΩ/2KΩ resistance supervision | \$100.00 |
| R04 | AMAG compatible 4-state supervision | \$100.00 |
| SC▲† | Schlage "C" Keyway cylinder, (Number 41 Cylinder Only, 0 bitted) | No addition |
| SE▲† | Schlage "E" Keyway cylinder, (Number 41 Cylinder Only, 0 bitted) | No addition |
| SG | MicroShield® – an antimicrobial powder coat finish | \$67.00 |
| WBS | Wrought Box Strike | No addition |
| NOTES: ▲ Options not avail. with a standard 50 function lockout cylinder. † Not avail. with 60, 63, 64 options | | |
| CPC | Clear Powder Coat over 26D/32D – NAC 82280-12V x LNA x RH x 32D x CPC All orders will continue to be handled as a "special" when CPC is ordered. | \$62.00 |

SARGENT®

ASSA ABLOY

ML-13 MORTISE LOCKS

NAC 8200 SERIES

USA & Canada Prices Effective June 3, 2019



LNJ

Rose: O, E, L, LN (Shown) Lever: J (Shown)

| NAC 8200 Electrified Mortise Locks with High Security Monitoring | | | | 10BE/26D/ BSP/WSP | 03/04/09/10/ 10B/10BL/14/15/ 20D/26/32/32D |
|--|----------------|------------------------|--------------------------------------|----------------------|--|
| Option | Function | Trim - Proximity Entry | Description | | |
| NAC | 82270-12V/-24V | Rose x Lever Design | Fail Safe w/Cylinder Override | \$1,266.00 | \$1,405.00 |
| NAC | 82271-12V/-24V | Rose x Lever Design | Fail Secure w/Cylinder Override | | |
| NAC | 82280-12V/-24V | Rose x Lever Design | Fail Safe w/Deadbolt w/Cyl.Override | \$1,341.00 | \$1,480.00 |
| NAC | 82281-12V/-24V | Rose x Lever Design | Fail Secure w/D.bolt w/Cyl.Override | | |
| NAC | 82274-12V/-24V | Rose x Lever Design | Fail Safe - No Cylinder | \$1,211.00 | \$1,350.00 |
| NAC | 82275-12V/-24V | Rose x Lever Design | Fail Secure - No Cylinder | | |
| NAC | 82284-12V/-24V | Rose x Lever Design | Fail Safe w/Deadbolt - No Cylinder | \$1,286.00 | \$1,425.00 |
| NAC | 82285-12V/-24V | Rose x Lever Design | Fail Secure w/Deadbolt - No Cylinder | | |

Note: Consult catalog for ordering information.

Specify hand and voltage (12v or 24v) when ordering

ML-14 MORTISE LOCKS

SARGENT®

ASSA ABLOY

OPTIONS

USA & Canada Prices Effective June 3, 2019

| Options | Description | Price |
|----------|---|---|
| 1▲ | 8200 Line with 1-1/16" wide front for 1-3/8" doors. | \$58.00 |
| 3 | Stainless steel hub (not available with 8289, 8291 & 8292 functions) | \$63.00 |
| 10▲ | SARGENT Signature Key System | \$58.00 / cyl. |
| 11†▲ | SARGENT XC Key System (not available with 10, 22, SC, SE options) | No addition |
| 1160 | SARGENT XC Large Format Interchangeable Plastic Disposable Construction Core | No addition |
| 1163 | SARGENT XC Large Format Interchangeable Core Cylinder - Includes masterkeying charges | \$77.00 |
| 1164 | SARGENT XC Large Format Interchangeable Construction Core Cylinder | \$77.00 |
| 1170 | Small Format interchangeable disposable construction core - to accept 7 Pin XC permanent core | No addition |
| 11727P | Small Format interchangeable keyed construction core - to accept 7 Pin XC permanent core | \$69.00 |
| 11737P | Small Format interchangeable core - to accept 7 pin XC permanent core | \$69.00 / cyl. |
| 21▲† | SARGENT Construction Key System (lost ball) Standard on all new systems established since 5/1/96 | \$16.00 / cyl. |
| 22▲† | SARGENT Construction Key System (split key) To be used on pre-established split key systems only | \$32.00 / cyl. |
| 23 | Locksets with flat 4-7/8" ANSI strike | No addition |
| 31 | Thick Doors - Extended Lip Required - Specify Length C to E - Cylinders - IMPORTANT- See catalog 7800/8200 option page for cylinder limitations - Below charges DO NOT include additional charges for special cylinder requirements | No addition |
| | Doors up to 2-1/2" thick - lock centered | No addition |
| | Doors 2-5/8" to 6" thick OR doors 1-3/4" thick w/max 1" paneling one side. For example: Specify 1-3/4" door with panel (Side) on inside or outside | Non Keyed function \$50.00 Keyed function \$100.00 |
| 36 | 6 Lobe security head screws | \$23.00 |
| 37 | Spanner head screws | \$16.00 |
| 60 | SARGENT Large Format Interchangeable Plastic Disposable Construction Core | No addition |
| 63 | SARGENT Large Format Interchangeable core cylinder, includes master keying charges | \$77.00 / cyl. |
| 64 | SARGENT Large Format Interchangeable Construction Core Cylinder | \$77.00 |
| 6573▲† | Small Format 6-Pin Uncombined Core (Refer to CK-12) | \$59.00 / cyl. |
| 65737P▲† | Small Format 7-Pin Uncombined Core (Refer to CK-12) | \$59.00 / cyl. |
| 68 | 8200 Line furnished with lever handle outside x knob inside (Excludes SLD Detention Knob) | Defaults to 8200 Lever Lock Price |
| 69 | 8200 Line furnished with lever handle inside x knob outside (Excludes SLD Detention Knob) | Defaults to 8200 Lever Lock Price |
| 70▲† | Small Format Interchangeable disposable plastic construction core | No addition |
| 72▲† | Small Format Interchangeable 6-pin construction core (7-pin with 11 option) | \$69.00 |
| 73▲† | Small Format interchangeable core 6-pin Includes MK and GMK keying charges | \$69.00 / cyl |
| 737P▲† | Small Format interchangeable core 7-pin (refer to CK-12 for available keyways) Includes MK and GMK keying charges | \$69.00 / cyl |
| 75 | Tactile Warning - Milled Inside Lever (Not available with A lever) | \$72.00 |
| 76 | Tactile Warning - Milled Outside Lever (Not available with A lever) | \$72.00 |
| 77 | Tactile Warning - Milled Outside and Inside Lever (Not available with A lever) | \$144.00 |
| 81▲† | Cylinder to accept Keso (83) and Keso F1 (F183) removable core – no core provided | No addition |
| F182† | SARGENT Keso Security Cylinder – patented – new key systems | \$84.00 / cyl. |
| F183▲† | SARGENT Keso Security Removable Core Cylinder – patented – new key systems | \$120.00 / cyl. |
| 82† | SARGENT Keso Security Cylinder (For existing systems only) | \$84.00 / cyl. |
| 83▲† | SARGENT Keso Security Removable Core Cylinder (for existing systems only) | \$120.00 / cyl. |
| 84▲† | SARGENT Keso Security Removable Construction Core Cylinder | See CK-18 |
| 85 | Tactile Warning - Abrasive Coating on Inside Lever | \$45.00 |
| 86 | Tactile Warning - Abrasive Coating on Outside Lever | \$45.00 |
| 87 | Tactile Warning - Abrasive Coating on Outside & Inside Lever | \$90.00 |
| AV | Anti Vandal Pull Trim (available in 32D finish), (Not available with 8270, 8271, 8272, 8273 functions) | \$212.00 |
| BR | SARGENT Bump Resistant Cylinders (N/A w/10, 22, 30, 60, 63, 64, 70, 72, 73, 737P, KESO, SC, & SE options) | \$23.00 / cyl. |
| DG1 | Patented Degree DG1 Key System | No Addition |
| DG160 | Hardware prepared for DG1-6300 Lg. Format IC cores, supplied with temporary plastic construction cores | No addition |
| DG163 | Patented Degree DG1 Large Format Interchangeable Core Cylinder - Includes master keying charges | \$77.00 |
| DG164 | Hardware prepared for DG1-6300 Lg. Format IC cores, supplied with temporary keyed construction cores | \$77.00 |
| DG2 | Patented Degree DG2 Key System incorporating a locking sidebar | \$58.00/cyl. |
| DG260 | Hardware prepared for DG2-6300 Lg. Format IC cores, supplied with temporary plastic construction cores | No addition |
| DG263 | Patented Degree DG2 Large Format Interchangeable Core Cylinder - Includes master keying charges | \$135.00 |
| DG264 | Hardware prepared for DG2-6300 Lg. Format IC cores, supplied with temporary keyed construction cores | \$77.00 |
| DG3 | Patented Degree DG3 Key System incorporating a locking sidebar and UL437 listed | \$82.00/cyl. |
| DG360 | Hardware prepared for DG3-6300 Lg. Format IC cores, supplied with temporary plastic construction cores | No addition |
| DG363 | Patented Degree DG3 Large Format Interchangeable Core Cylinder - Includes master keying charges | \$159.00 |
| DG364 | Hardware prepared for DG3-6300 Lg. Format IC cores, supplied with temporary keyed construction cores | \$77.00 |
| EMA* | "Lock" directional arrow engraving provided for outside LE1 escutcheon trim only | \$44.00 |
| EMB* | "Lock" directional arrow engraving provided for inside LE1 escutcheon trim only | \$44.00 |
| EMC* | "Lock" directional arrow engraving provided for both sides of LE1 escutcheon trim | \$88.00 |
| DX | Deadbolt Monitoring (not available with 50, 74) | \$182.00 |
| LB | Extra large thumbturn | \$16.00 |
| LC | Less Cylinder | -\$89.00/cyl. |
| LX | Latchbolt Monitor – available with all non-deadbolt functions; not available with DX option | \$185.00 |
| OBS | Open Back Strike | \$73.00 |
| RX | Request to Exit | \$190.00 |
| SC▲† | Schlage "C" Keyway cylinder, (Number 41 Cylinder Only, 0 bitted) | No addition |
| SE▲† | Schlage "E" Keyway cylinder, (Number 41 Cylinder Only, 0 bitted) | No addition |
| SG | MicroShield® – an antimicrobial powder coat finish | \$67.00 |
| VNA | Status indicator provided for the outside LE1 escutcheon trim only | \$92.00 |
| VNB | Status indicator provided for the inside LE1 escutcheon trim only | \$92.00 |
| VNC | Status indicators provided for both sides of LE1 escutcheon trim | \$184.00 |
| WBS | Wrought Box Strike | No addition |

NOTES: ▲ Options not avail. with a standard 50 function lockout cylinder. † Not avail. with 60, 63, 64 options

CPC Clear Powder Coat over 26D/32D – 8205 x LE1L x RH x 32D x CPC \$62.00
All orders will continue to be handled as a "special" when CPC is ordered.

ASSA ABLOY, the global leader
in door opening solutions

Copyright © 2002-2019 Sargent Manufacturing Company, an ASSA ABLOY Group company. All rights reserved.
Reproduction in whole or in part without the express written permission of Sargent Manufacturing Company is prohibited.
Contact us at: 800-727-5477 or visit www.sargentlock.com. In Canada contact us at: 800-461-3007 or visit www.assaabloydss.ca

ASSA ABLOY

8200

USA & Canada
Prices Effective
June 3, 2019

LE1 Escutcheon Prices shown
LE2, LE3, LE4 Escutcheons – refer to below for add
• A-B-E-F-J-L-P-W Levers



| Function | Finish | |
|---|------------------|--|
| | 10BE/26D/BSP/WSP | 03/04/09/10/10B/10BL/14/15/20D/26/32/32D |
| Single Cyl | | |
| 8204 Storeroom or Closet | | |
| 8205 Office or Entry | | |
| 8237 Classroom | \$1,054.00 | \$1,078.00 |
| 8255 Office or Entry | | |
| 8206 Storeroom or Service | | |
| 8231 Utility | | |
| 8236 Closet | | |
| 8256 Office or Inner Entry | | |
| 8257, 8258, 8267 Institutional Privacy | \$1,075.00 | \$1,099.00 |
| 8289 Holdback | | |
| 8291 All Purpose Holdback | | |
| Single Cyl With Deadbolt | | |
| 8224 Room Door | | |
| 8225 Dormitory or Exit | | |
| 8227 Closet or Storeroom | | |
| 8228, 8230 Dummy Trim Deadlock | | |
| 8235 Storeroom | \$1,104.00 | \$1,128.00 |
| 8243 Apartment Corridor | | |
| 8245 Dormitory or Exit | | |
| 8247 Front Door or Apartment Corridor | | |
| 8251 Storeroom Deadbolt | | |
| 8250 Hotel Guest Lock | \$1,145.00 | \$1,169.00 |
| Double Cyl No Deadbolt | | |
| 8216 Apartment or Exit or Public Toilet | | |
| 8217 Asylum or Institutional | | |
| 8238 Classroom Security Intruder | \$1,154.00 | \$1,178.00 |
| 8259 School Security | | |
| 8290 Classroom Security Holdback | | |
| 8292 All Purpose Holdback | | |
| Double Cyl With Deadbolt | | |
| 8226 Store Door | | |
| 8229 Dummy Trim Deadlock | | |
| 8239, 8240 Classroom Security Intruder | | |
| 8241 Classroom Security | \$1,179.00 | \$1,203.00 |
| 8246 Dormitory or Exit | | |
| 8248 Store Door | | |
| 8249 Security Deadbolt | | |
| 8252 Institutional | | |
| Electro Mechanical Single Cyl – Specify 12V or 24V | | |
| 8270-12V / 8270-24V Fail Safe | \$1,250.00 | \$1,274.00 |
| 8271-12V / 8271-24V Fail Secure | | |
| Electro Mechanical Double Cyl – Specify 12V or 24V | | |
| 8272-12V / 8272-24V Fail Safe | \$1,307.00 | \$1,331.00 |
| 8273-12V / 8273-24V Fail Secure | | |
| Non Keyed | | |
| 8213 Communication or Exit | \$843.00 | \$867.00 |
| 8215 Passage or Closet | | |
| 8265 Privacy Bedroom or Bath (Latch) | \$942.00 | \$966.00 |
| 8266, 8268 Privacy Bedroom or Bath (Deadbolt) | \$997.00 | \$1,021.00 |
| 8293* Single Dummy Trim | \$348.00 | \$360.00 |
| 8294 Double Dummy Trim | \$695.00 | \$719.00 |
| 8295 Single Dummy Trim w/Lockbody | \$444.00 | \$456.00 |
| 8296 Double Dummy Trim w/Lockbody | \$792.00 | \$816.00 |
| 8297 Double Dummy w/Active Trim | \$874.00 | \$898.00 |

**A" Lever Only—Specify hand and if for inside or outside of door, when ordering.

| Escutcheon Variations | Escutcheon | Description | Price |
|-----------------------|------------|--|-------------|
| Standard Cylinder | LE2 | x concealed mounting | \$29.00 |
| Non-Keyed Function | LE2 | x concealed mounting | \$29.00 |
| Cylinder Barrel Only | LE3 | x exposed screws (not avail. in double cyl. functions) | \$82.00 Set |
| Non-Keyed Function | LE3 | x exposed screws | \$29.00 |
| Cylinder Barrel Only | LE4 | x concealed mounting (not avail. in double cyl. functions) | \$82.00 |
| Non-Keyed Function | LE4 | x concealed mounting | \$29.00 |

ML-16 MORTISE LOCKS

SARGENT®

OPTIONS

ASSA ABLOY

USA & Canada Prices Effective June 3, 2019

| Options | Description | Price |
|--------------------|--|---|
| 1▲ | 8200 Line with 1-1/16" wide front for 1-3/8" doors. | \$58.00 |
| 3 | Stainless steel hub (not available with 8289, 8291 & 8292 functions) | \$63.00 |
| 10▲ | SARGENT Signature Key System | \$58.00 / cyl. |
| 11†▲ | SARGENT XC Key System (not available w/10, KESO, SC, SE) | No addition |
| 1160 | SARGENT XC Large Format Interchangeable Plastic Disposable Construction Core | No addition |
| 1163 | SARGENT XC Large Format Interchangeable Core Cylinder - Includes masterkeying charges | \$77.00 |
| 1164 | SARGENT XC Large Format Interchangeable Construction Core Cylinder | \$77.00 |
| 1170 | Small Format interchangeable disposable construction core - to accept 7 Pin XC permanent core | No addition |
| 11727P | Small Format interchangeable keyed construction core - to accept 7 Pin XC permanent core | \$69.00 |
| 11737P | Small Format interchangeable core - to accept 7 pin XC permanent core | \$69.00 / cyl. |
| 21▲† | SARGENT Construction Key System (lost ball) Standard on all new systems established since 5/1/96 | \$16.00 / cyl. |
| 22▲† | SARGENT Construction Key System (split key) To be used on pre-established split key systems only | \$32.00 / cyl. |
| 23 | Locksets with flat 4 7/8" ANSI strike | No addition |
| 31 | Thick Doors - Extended Lip Required - Specify Length C to E IMPORTANT: See 7800/8200 Catalog Option Page for Cylinder Limits – DOES NOT include additional Charges for Special Cylinder Requirements Doors up to 2-1/2" thick - lock centered • Doors 2-5/8" to 6" thick OR doors 1-3/4" thick w/max 1" paneling one side. For example: Specify 1-3/4" door with panel (Side) on inside or outside | No addition Non Keyed function \$50.00 Keyed function \$100.00 |
| 36 | 6 Lobe security head screws | \$23.00 |
| 37 | Spanner head screws | \$16.00 |
| 60 | SARGENT Large Format Interchangeable Plastic Disposable Construction Core | No addition |
| 63 | SARGENT Large Format Interchangeable core cylinder, includes master keying charges | \$77.00 / cyl |
| 64 | SARGENT Large Format Interchangeable Construction Core Cylinder | \$77.00 |
| 6573▲† | Small Format 6-Pin Uncombined Core (Refer to CK-12) | \$59.00 / cyl. |
| 65737P▲† | Small Format 7-Pin Uncombined Core (Refer to CK-12) | \$59.00 / cyl. |
| 68 | 8200 Line furnished with lever handle outside x knob inside (Excludes SLD Detention Knob) | Defaults to 8200 Lever Lock Price |
| 69 | 8200 Line furnished with lever handle inside x knob outside (Excludes SLD Detention Knob) | Defaults to 8200 Lever Lock Price |
| 70▲† | Small Format interchangeable disposable plastic construction core | No addition |
| 72▲† | Small Format interchangeable 6-Pin construction core | \$69.00 |
| 73▲† | Small Format interchangeable core 6-pin Includes MK and GMK keying charges | \$69.00 / cyl |
| 737P▲† | Small Format interchangeable core 7-pin (refer to CK-12 for available keyways) Includes MK and GMK keying charges | \$69.00 / cyl |
| 75 | Tactile Warning - Milled Inside Lever | \$72.00 |
| 76 | Tactile Warning - Milled Outside Lever | \$72.00 |
| 77 | Tactile Warning - Milled Outside and Inside Lever | \$144.00 |
| 81▲† | Cylinder to accept Keso (83) and Keso F1 (F183) removable core – no core provided | No addition |
| F182† | SARGENT Keso Security Cylinder – patented – new key systems | \$84.00 / cyl. |
| F183▲† | SARGENT Keso Security Removable Core Cylinder – patented – new key systems | \$120.00 / cyl. |
| 82† | SARGENT Keso Security Cylinder (For existing systems only) | \$84.00 / cyl. |
| 83▲† | SARGENT Keso Security Removable Core Cylinder (For existing systems only) | \$120.00 / cyl. |
| 84▲† | SARGENT Keso Security Removable Construction Core Cylinder | See CK-18 |
| 85 | Tactile Warning - Abrasive Coating on Inside Lever | \$45.00 |
| 86 | Tactile Warning - Abrasive Coating on Outside Lever | \$45.00 |
| 87 | Tactile Warning - Abrasive Coating on Outside & Inside Lever | \$90.00 |
| AV | Anti Vandal Pull Trim (available in 32D finish), (Not available with 8270, 8271, 8272, 8273 functions) | \$212.00 |
| BR | SARGENT Bump Resistant Cylinders (N/A w/10, 22, 30, 60, 63, 64, 70, 72, 73, 737P, KESO, SC, & SE options) | \$23.00 /cyl. |
| DG1 | Patented Degree DG1 Key System | No Addition |
| DG160 | Hardware prepared for DG1-6300 Lg. Format IC cores, supplied with temporary plastic construction cores | No addition |
| DG163 | Patented Degree DG1 Large Format Interchangeable Core Cylinder - Includes master keying charges | \$77.00 |
| DG164 | Hardware prepared for DG1-6300 Lg. Format IC cores, supplied with temporary keyed construction cores | \$77.00 |
| DG2 | Patented Degree DG2 Key System incorporating a locking sidebar | \$58.00/cyl. |
| DG260 | Hardware prepared for DG2-6300 Lg. Format IC cores, supplied with temporary plastic construction cores | No addition |
| DG263 | Patented Degree DG2 Large Format Interchangeable Core Cylinder - Includes master keying charges | \$135.00 |
| DG264 | Hardware prepared for DG2-6300 Lg. Format IC cores, supplied with temporary keyed construction cores | \$77.00 |
| DG3 | Patented Degree DG3 Key System incorporating a locking sidebar and UL437 listed | \$82.00/cyl. |
| DG360 | Hardware prepared for DG3-6300 Lg. Format IC cores, supplied with temporary plastic construction cores | No addition |
| DG363 | Patented Degree DG3 Large Format Interchangeable Core Cylinder - Includes master keying charges | \$159.00 |
| DG364 | Hardware prepared for DG3-6300 Lg. Format IC cores, supplied with temporary keyed construction cores | \$77.00 |
| EMA* | "Lock" directional arrow engraving provided for outside LE1 escutcheon trim only | \$44.00 |
| EMB* | "Lock" directional arrow engraving provided for inside LE1 escutcheon trim only | \$44.00 |
| EMC* | "Lock" directional arrow engraving provided for both sides of LE1 escutcheon trim | \$88.00 |
| IDP | Integrated Door Position Switch | \$100.00 |
| LB | Extra large thumbturn | \$16.00 |
| LC | Less Cylinder | -\$89.00/cyl. |
| OBS | Open Back Strike | \$73.00 |
| PHR | Deadbolt Privacy Function (available w/deadbolt function only) | \$100.00 |
| R01 | Mercury and Lenel compatible 1KΩ/2KΩ resistance supervision | \$100.00 |
| R03 | Software House compatible 1KΩ/2KΩ resistance supervision | \$100.00 |
| R04 | AMAG compatible 4-state supervision | \$100.00 |
| SC▲† | Schlage "C" Keyway cylinder, (Number 41 Cylinder Only, 0 bitted) | No addition |
| SE▲† | Schlage "E" Keyway cylinder, (Number 41 Cylinder Only, 0 bitted) | No addition |
| SG | MicroShield® – an antimicrobial powder coat finish | \$67.00 |
| VNA | Status indicator provided for the outside LE1 escutcheon trim only | \$92.00 |
| VNB | Status indicator provided for the inside LE1 escutcheon trim only | \$92.00 |
| VNC | Status indicators provided for both sides of LE1 escutcheon trim | \$184.00 WBS |
| Wrought Box Strike | | No addition |

NOTES: ▲ Options not avail. with a standard 50 function lockout cylinder. † Not avail. with 60, 63, 64 options

| | | |
|-----|--|---------|
| CPC | Clear Powder Coat over 26D/32D – NAC 82280-24V x LE1A x RH x 32D x CPC All orders will continue to be handled as a "special" when CPC is ordered. | \$62.00 |
|-----|--|---------|

USA & Canada Prices Effective June 3, 2019

LE1 Escutcheon Prices shown
LE2, LE3, LE4 Escutcheons – refer to ML-8 for add
• A-B-E-F-J-L-P-W Levers



| NAC 8200 Electrified Mortise Locks with High Security Monitoring | | | | 10BE/26D/ BSP/WSP | 03/04/09/10/ 10B/10BL/14/15/ 20D/26/32/32D |
|--|----------------|------------------------|--------------------------------------|----------------------|--|
| Option | Function | Trim - Proximity Entry | Description | | |
| NAC | 82270-12V/-24V | Rose x Lever Design | Fail Safe w/Cylinder Override | \$1,425.00 | \$1,449.00 |
| NAC | 82271-12V/-24V | Rose x Lever Design | Fail Secure w/Cylinder Override | | |
| NAC | 82280-12V/-24V | Rose x Lever Design | Fail Safe w/Deadbolt w/Cyl.Override | \$1,500.00 | \$1,524.00 |
| NAC | 82281-12V/-24V | Rose x Lever Design | Fail Secure w/D.bolt w/Cyl.Override | | |
| NAC | 82274-12V/-24V | Rose x Lever Design | Fail Safe - No Cylinder | \$1,370.00 | \$1,394.00 |
| NAC | 82275-12V/-24V | Rose x Lever Design | Fail Secure - No Cylinder | | |
| NAC | 82284-12V/-24V | Rose x Lever Design | Fail Safe w/Deadbolt - No Cylinder | \$1,445.00 | \$1,469.00 |
| NAC | 82285-12V/-24V | Rose x Lever Design | Fail Secure w/Deadbolt - No Cylinder | | |

Note: Consult catalog for ordering information.
Specify hand and voltage (12v or 24v) when ordering

ML-18 MORTISE LOCKS

SARGENT®

ASSA ABLOY

OPTIONS

USA & Canada Prices Effective June 3, 2019

| Options | Description | Price |
|----------|---|--|
| 1▲ | 8200 Line with 1-1/16" wide front for 1-3/8" doors. | \$58.00 |
| 3 | Stainless steel hub (not available with 8289, 8291 & 8292 functions) | \$63.00 |
| 10▲ | SARGENT Signature Key System | \$58.00 / cyl. |
| 11†▲ | SARGENT XC Key System (not available with 10, 22, SC, SE options) | No addition |
| 1160 | SARGENT XC Large Format Interchangeable Plastic Disposable Construction Core | No addition |
| 1163 | SARGENT XC Large Format Interchangeable Core Cylinder - Includes masterkeying charges | \$77.00 |
| 1164 | SARGENT XC Large Format Interchangeable Construction Core Cylinder | \$77.00 |
| 1170 | Small Format interchangeable disposable construction core - to accept 7 Pin XC permanent core | No addition |
| 11727P | Small Format interchangeable keyed construction core - to accept 7 Pin XC permanent core | \$69.00 |
| 11737P | Small Format interchangeable core - to accept 7 pin XC permanent core | \$69.00 /cyl. |
| 21▲† | SARGENT Construction Key System (lost ball) Standard on all new systems established since 5/1/96 | \$16.00 / cyl. |
| 22▲† | SARGENT Construction Key System (split key) To be used on pre-established split key systems only | \$32.00 / cyl. |
| 23 | Locksets with flat 4-7/8" ANSI strike | No addition |
| 31 | Thick Doors - Extended Lip Required - Specify Length C to E | |
| | - Cylinders - IMPORTANT- See catalog 7800/8200 option page for cylinder limitations | |
| | - Below charges DO NOT include additional charges for special cylinder requirements | |
| | Doors up to 2-1/2" thick - lock centered | No addition |
| | Doors 2-5/8" to 6" thick OR doors 1-3/4" thick w/max 1" paneling one side. | |
| | For example: Specify 1-3/4" door with panel (Side) on inside or outside | Non Keyed function \$50.00 Keyed function \$100.00 |
| 36 | 6 Lobe security head screws | \$23.00 |
| 37 | Spanner head screws | \$16.00 |
| 60 | SARGENT Large Format Interchangeable Plastic Disposable Construction Core | No addition |
| 63 | SARGENT Large Format Interchangeable core cylinder, includes master keying charges | \$77.00 / cyl. |
| 64 | SARGENT Large Format Interchangeable Construction Core Cylinder | \$77.00 |
| 6573▲† | Small Format 6-Pin Uncombined Core (Refer to CK-12) | \$59.00 / cyl. |
| 65737P▲† | Small Format 7-Pin Uncombined Core (Refer to CK-12) | \$59.00 / cyl. |
| 68 | 8200 Line furnished with lever handle outside x knob inside (Excludes SLD Detention Knob) | Defaults to 8200 Lever Lock Price |
| 69 | 8200 Line furnished with lever handle inside x knob outside (Excludes SLD Detention Knob) | Defaults to 8200 Lever Lock Price |
| 70▲† | Small Format Interchangeable disposable plastic construction core | No addition |
| 72▲† | Small Format Interchangeable 6-pin construction core (7-pin with 11 option) | \$69.00 |
| 73▲† | Small Format interchangeable core 6-pin Includes MK and GMK keying charges | \$69.00 / cyl |
| 737P▲† | Small Format interchangeable core 7-pin (refer to CK-12 for available keyways) Includes MK and GMK keying charges | \$69.00 / cyl |
| 75 | Tactile Warning - Milled Inside Lever (Not available with A lever) | \$72.00 |
| 76 | Tactile Warning - Milled Outside Lever (Not available with A lever) | \$72.00 |
| 77 | Tactile Warning - Milled Outside and Inside Lever (Not available with A lever) | \$144.00 |
| 81▲† | Cylinder to accept Keso (83) and Keso F1 (F183) removable core – no core provided | No addition |
| F182† | SARGENT Keso Security Cylinder – patented – new key systems | \$84.00 / cyl. |
| F183▲† | SARGENT Keso Security Removable Core Cylinder – patented – new key systems | \$120.00 / cyl. |
| 82† | SARGENT Keso Security Cylinder (For existing systems only) | \$84.00 / cyl. |
| 83▲† | SARGENT Keso Security Removable Core Cylinder (For existing systems only) | \$120.00 / cyl. |
| 84▲† | SARGENT Keso Security Removable Construction Core Cylinder | See CK-18 |
| 85 | Tactile Warning - Abrasive Coating on Inside Lever | \$45.00 |
| 86 | Tactile Warning - Abrasive Coating on Outside Lever | \$45.00 |
| 87 | Tactile Warning - Abrasive Coating on Outside & Inside Lever | \$90.00 |
| AV | Anti Vandal Pull Trim (available in 32D finish), (Not available with 8270, 8271, 8272, 8273 functions) | \$212.00 |
| BR | SARGENT Bump Resistant Cylinders (N/A w/10, 22, 30, 60, 63, 64, 70, 72, 73, 737P, KESO, SC, & SE options) | \$23.00 /cyl. |
| DG1 | Patented Degree DG1 Key System | No Addition |
| DG160 | Hardware prepared for DG1-6300 Lg. Format IC cores, supplied with temporary plastic construction cores | No addition |
| DG163 | Patented Degree DG1 Large Format Interchangeable Core Cylinder - Includes master keying charges | \$77.00 |
| DG164 | Hardware prepared for DG1-6300 Lg. Format IC cores, supplied with temporary keyed construction cores | \$77.00 |
| DG2 | Patented Degree DG2 Key System incorporating a locking sidebar | \$58.00/cyl. |
| DG260 | Hardware prepared for DG2-6300 Lg. Format IC cores, supplied with temporary plastic construction cores | No addition |
| DG263 | Patented Degree DG2 Large Format Interchangeable Core Cylinder - Includes master keying charges | \$135.00 |
| DG264 | Hardware prepared for DG2-6300 Lg. Format IC cores, supplied with temporary keyed construction cores | \$77.00 |
| DG3 | Patented Degree DG3 Key System incorporating a locking sidebar and UL437 listed | \$82.00/cyl. |
| DG360 | Hardware prepared for DG3-6300 Lg. Format IC cores, supplied with temporary plastic construction cores | No addition |
| DG363 | Patented Degree DG3 Large Format Interchangeable Core Cylinder - Includes master keying charges | \$159.00 |
| DG364 | Hardware prepared for DG3-6300 Lg. Format IC cores, supplied with temporary keyed construction cores | \$77.00 |
| DX | Deadbolt Monitoring (not available with 50, 74) | \$182.00 |
| LB | Extra large thumbturn | \$16.00 |
| LC | Less Cylinder | -\$89.00/cyl. |
| LX | Latchbolt Monitor – available with all non-deadbolt functions; not available with DX option | \$185.00 |
| OBS | Open Back Strike | \$73.00 |
| RX | Request to Exit | \$190.00 |
| SC▲† | Schlage "C" Keyway cylinder, (Number 41 Cylinder Only, 0 bitted) | No addition |
| SE▲† | Schlage "E" Keyway cylinder, (Number 41 Cylinder Only, 0 bitted) | No addition |
| SG | MicroShield® – an antimicrobial powder coat finish | \$67.00 |
| WBS | Wrought Box Strike | No addition |

NOTES: ▲ Options not avail. with a standard 50 function lockout cylinder. † Not avail. with 60, 63, 64 options

| | | |
|-----|---|---------|
| CPC | Clear Powder Coat over 26D/32D – 8205 x LW1L x RH x 32D x CPC All orders will continue to be handled as a "special" when CPC is ordered. | \$62.00 |
|-----|---|---------|

LW1 Escutcheon
• A-B-E-F-J-L-P-W Levers



| Function | | Finish | |
|---|------------------------------------|------------------|--|
| | | 10BE/26D/BSP/WSP | 03/04/09/10/10B/10BL/14/15/20D/26/32/32D |
| Single Cyl | | | |
| 8204 | Storeroom or Closet | | |
| 8205 | Office or Entry | | |
| 8237 | Classroom | \$1,009.00 | \$1,033.00 |
| 8255 | Office or Entry | | |
| <hr/> | | | |
| 8206 | Storeroom or Service | | |
| 8231 | Utility | | |
| 8236 | Closet | \$1,033.00 | \$1,057.00 |
| 8256 | Office or Inner Entry | | |
| 8257, 8258, 8267 | Institutional Privacy | | |
| 8289 | Holdback | | |
| 8291 | All Purpose Holdback | | |
| Single Cyl With Deadbolt | | | |
| 8224 | Room Door | | |
| 8225 | Dormitory or Exit | | |
| 8227 | Closet or Storeroom | | |
| 8228, 8230 | Dummy Trim Deadlock | | |
| 8235 | Storeroom | \$1,061.00 | \$1,085.00 |
| 8243 | Apartment Corridor | | |
| 8245 | Dormitory or Exit | | |
| 8247 | Front Door or Apartment Corridor | | |
| 8251 | Storeroom Deadbolt | | |
| 8250 | Hotel Guest Lock | \$1,096.00 | \$1,120.00 |
| Double Cyl No Deadbolt | | | |
| 8216 | Apartment or Exit or Public Toilet | | |
| 8217 | Asylum or Institutional | | |
| 8238 | Classroom Security Intruder | \$1,114.00 | \$1,138.00 |
| 8259 | School Security | | |
| 8290 | Classroom Security Holdback | | |
| 8292 | All Purpose Holdback | | |
| Double Cyl With Deadbolt | | | |
| 8226 | Store Door | | |
| 8229 | Dummy Trim Deadlock | | |
| 8239, 8240 | Classroom Security Intruder | | |
| 8241 | Classroom Security | \$1,135.00 | \$1,159.00 |
| 8246 | Dormitory or Exit | | |
| 8248 | Store Door | | |
| 8249 | Security Deadbolt | | |
| 8252 | Institutional | | |
| Electro Mechanical Single Cyl – Specify 12V or 24V | | | |
| 8270-12V / 8270-24V | Fail Safe | \$1,205.00 | \$1,229.00 |
| 8271-12V / 8271-24V | Fail Secure | | |
| Electro Mechanical Double Cyl – Specify 12V or 24V | | | |
| 8272-12V / 8272-24V | Fail Safe | \$1,262.00 | \$1,286.00 |
| 8273-12V / 8273-24V | Fail Secure | | |
| Non Keyed | | | |
| 8213 | Communication or Exit | \$828.00 | \$852.00 |
| 8215 | Passage or Closet | | |
| 8265 | Privacy Bedroom or Bath (Latch) | \$913.00 | \$937.00 |
| 8266, 8268 | Privacy Bedroom or Bath (Deadbolt) | \$972.00 | \$996.00 |
| 8293* | Single Dummy Trim | \$320.00 | \$332.00 |
| 8294 | Double Dummy Trim | \$649.00 | \$673.00 |
| 8295 | Single Dummy Trim w/Lockbody | \$421.00 | \$433.00 |
| 8296 | Double Dummy Trim w/Lockbody | \$747.00 | \$771.00 |
| 8297 | Double Dummy w/Active Trim | \$828.00 | \$852.00 |

**A" Lever Only—Specify hand and if for inside or outside of door, when ordering.

ML-20 MORTISE LOCKS

SARGENT®

ASSA ABLOY

OPTIONS

USA & Canada Prices Effective June 3, 2019

| Options | Description | Price |
|---------------|--|--|
| 1▲ | 8200 Line with 1-1/16" wide front for 1-3/8" doors. | \$58.00 |
| 3 | Stainless steel hub (not available with 8289, 8291 & 8292 functions) | \$63.00 |
| 10▲ | SARGENT Signature Key System | \$58.00 / cyl. |
| 11†▲ | SARGENT XC Key System (not available w/10, KESO, SC, SE) | No addition |
| 1160 | SARGENT XC Large Format Interchangeable Plastic Disposable Construction Core | No addition |
| 1163 | SARGENT XC Large Format Interchangeable Core Cylinder - Includes masterkeying charges | \$77.00 |
| 1164 | SARGENT XC Large Format Interchangeable Construction Core Cylinder | \$77.00 |
| 1170 | Small Format interchangeable disposable construction core - to accept 7 Pin XC permanent core | No addition |
| 11727P | Small Format interchangeable keyed construction core - to accept 7 Pin XC permanent core | \$69.00 |
| 11737P | Small Format interchangeable core - to accept 7 pin XC permanent core | \$69.00 /cyl. |
| 21▲† | SARGENT Construction Key System (lost ball) Standard on all new systems established since 5/1/96 | \$16.00 / cyl. |
| 22▲† | SARGENT Construction Key System (split key) To be used on pre-established split key systems only | \$32.00 / cyl. |
| 23 | Locksets with flat 4 7/8" ANSI strike | No addition |
| 31 | Thick Doors - Extended Lip Required - Specify Length C to E IMPORTANT: See 7800/8200 Catalog Option Page for Cylinder Limits – DOES NOT include additional Charges for Special Cylinder Requirements | No addition |
| | Doors up to 2-1/2" thick - lock centered • Doors 2-5/8" to 6" thick OR doors 1-3/4" thick w/max 1" paneling one side. For example: Specify 1-3/4" door with panel (Side) on inside or outside | Non Keyed function \$50.00 Keyed function \$100.00 |
| 36 | 6 Lobe security head screws | \$23.00 |
| 37 | Spanner head screws | \$16.00 |
| 60 | SARGENT Large Format Interchangeable Plastic Disposable Construction Core | No addition |
| 63 | SARGENT Large Format Interchangeable core cylinder, includes master keying charges | \$77.00 / cyl |
| 64 | SARGENT Large Format Interchangeable Construction Core Cylinder | \$77.00 |
| 6573▲† | Small Format 6-Pin Uncombined Core (Refer to CK-12) | \$59.00 / cyl. |
| 65737P▲† | Small Format 7-Pin Uncombined Core (Refer to CK-12) | \$59.00 / cyl. |
| 68 | 8200 Line furnished with lever handle outside x knob inside (Excludes SLD Detention Knob) | Defaults to 8200 Lever Lock Price |
| 69 | 8200 Line furnished with lever handle inside x knob outside (Excludes SLD Detention Knob) | Defaults to 8200 Lever Lock Price |
| 70▲† | Small Format interchangeable disposable plastic construction core | No addition |
| 72▲† | Small Format interchangeable 6-Pin construction core | \$69.00 |
| 73▲† | Small Format interchangeable core 6-pin Includes MK and GMK keying charges | \$69.00 / cyl |
| 737P▲† | Small Format interchangeable core 7-pin (refer to CK-12 for available keyways) Includes MK and GMK keying charges | \$69.00 / cyl |
| 75 | Tactile Warning - Milled Inside Lever | \$72.00 |
| 76 | Tactile Warning - Milled Outside Lever | \$72.00 |
| 77 | Tactile Warning - Milled Outside and Inside Lever | \$144.00 |
| 81▲† | Cylinder to accept Keso (83) and Keso F1 (F183) removable core – no core provided | No addition |
| F182† | SARGENT Keso Security Cylinder – patented – new key systems | \$84.00 / cyl. |
| F183▲† | SARGENT Keso Security Removable Core Cylinder – patented – new key systems | \$120.00 / cyl. |
| 82† | SARGENT Keso Security Cylinder (For existing systems only) | \$84.00 / cyl. |
| 83▲† | SARGENT Keso Security Removable Core Cylinder (For existing systems only) | \$120.00 / cyl. |
| 84▲† | SARGENT Keso Security Removable Construction Core Cylinder | See CK-18 |
| 85 | Tactile Warning - Abrasive Coating on Inside Lever | \$45.00 |
| 86 | Tactile Warning - Abrasive Coating on Outside Lever | \$45.00 |
| 87 | Tactile Warning - Abrasive Coating on Outside & Inside Lever | \$90.00 |
| AV | Anti Vandal Pull Trim (available in 32D finish), (Not available with 8270, 8271, 8272, 8273 functions) | \$212.00 |
| BR | SARGENT Bump Resistant Cylinders (N/A w/10, 22, 30, 60, 63, 64, 70, 72, 73, 737P, KESO, SC, & SE options) | \$23.00 /cyl. |
| DG1 | Patented Degree DG1 Key System | No Addition |
| DG160 | Hardware prepared for DG1-6300 Lg. Format IC cores, supplied with temporary plastic construction cores | No addition |
| DG163 | Patented Degree DG1 Large Format Interchangeable Core Cylinder - Includes master keying charges | \$77.00 |
| DG164 | Hardware prepared for DG1-6300 Lg. Format IC cores, supplied with temporary keyed construction cores | \$77.00 |
| DG2 | Patented Degree DG2 Key System incorporating a locking sidebar | \$58.00/cyl. |
| DG260 | Hardware prepared for DG2-6300 Lg. Format IC cores, supplied with temporary plastic construction cores | No addition |
| DG263 | Patented Degree DG2 Large Format Interchangeable Core Cylinder - Includes master keying charges | \$135.00 |
| DG264 | Hardware prepared for DG2-6300 Lg. Format IC cores, supplied with temporary keyed construction cores | \$77.00 |
| DG3 | Patented Degree DG3 Key System incorporating a locking sidebar and UL437 listed | \$82.00/cyl. |
| DG360 | Hardware prepared for DG3-6300 Lg. Format IC cores, supplied with temporary plastic construction cores | No addition |
| DG363 | Patented Degree DG3 Large Format Interchangeable Core Cylinder - Includes master keying charges | \$159.00 |
| DG364 | Hardware prepared for DG3-6300 Lg. Format IC cores, supplied with temporary keyed construction cores | \$77.00 |
| IDP | Integrated Door Position Switch | \$100.00 |
| LB | Extra large thumbturn | \$16.00 |
| LC | Less Cylinder | -\$89.00/cyl. |
| OBS | Open Back Strike | \$73.00 |
| PHR | Deadbolt Privacy Function (available w/deadbolt function only) | \$100.00 |
| R01 | Mercury and Lenel compatible 1KΩ/2KΩ resistance supervision | \$100.00 |
| R03 | Software House compatible 1KΩ/2KΩ resistance supervision | \$100.00 |
| R04 | AMAG compatible 4-state supervision | \$100.00 |
| SC▲† | Schlage "C" Keyway cylinder, (Number 41 Cylinder Only, 0 bitting) | No addition |
| SE▲† | Schlage "E" Keyway cylinder, (Number 41 Cylinder Only, 0 bitting) | No addition |
| SG | MicroShield® – an antimicrobial powder coat finish | \$67.00 |
| WBS | Wrought Box Strike | No addition |
| NOTES: | ▲ Options not avail. with a standard 50 function lockout cylinder. † Not avail. with 60, 63, 64 options | |
| CPC | Clear Powder Coat over 26D/32D – NAC-82280-24V x LW1A x RH x 32D x CPC All orders will continue to be handled as a "special" when CPC is ordered. | \$62.00 |

USA & Canada Prices Effective June 3, 2019

LW1 Escutcheon
• A-B-E-F-J-L-P-W Levers



| NAC 8200 Electrified Mortise Locks with High Security Monitoring | | | | 10BE/26D/ BSP/WSP | 03/04/09/10/ 10B/10BL/14/15/ 20D/26/32/32D |
|--|----------------|------------------------|--------------------------------------|----------------------|--|
| Option | Function | Trim - Proximity Entry | Description | | |
| NAC | 82270-12V/-24V | Rose x Lever Design | Fail Safe w/Cylinder Override | \$1,380.00 | \$1,404.00 |
| NAC | 82271-12V/-24V | Rose x Lever Design | Fail Secure w/Cylinder Override | | |
| NAC | 82280-12V/-24V | Rose x Lever Design | Fail Safe w/Deadbolt w/Cyl.Override | \$1,455.00 | \$1,479.00 |
| NAC | 82281-12V/-24V | Rose x Lever Design | Fail Secure w/D.bolt w/Cyl.Override | | |
| NAC | 82274-12V/-24V | Rose x Lever Design | Fail Safe - No Cylinder | \$1,325.00 | \$1,349.00 |
| NAC | 82275-12V/-24V | Rose x Lever Design | Fail Secure - No Cylinder | | |
| NAC | 82284-12V/-24V | Rose x Lever Design | Fail Safe w/Deadbolt - No Cylinder | \$1,400.00 | \$1,424.00 |
| NAC | 82285-12V/-24V | Rose x Lever Design | Fail Secure w/Deadbolt - No Cylinder | | |

Note: Consult catalog for ordering information.
Specify hand and voltage (12v or 24v) when ordering

ML-22 MORTISE LOCKS

SARGENT®

ASSA ABLOY

OPTIONS

USA & Canada Prices Effective June 3, 2019

| Options | Description | Price |
|----------|--|---|
| 1▲ | 8200 Line with 1-1/16" wide front for 1-3/8" doors. | \$58.00 |
| 3 | Stainless steel hub (not available with 8289, 8291 & 8292 functions) | \$63.00 |
| 10▲ | SARGENT Signature Key System | \$58.00 / cyl. |
| 11†▲ | SARGENT XC Key System (not available with 10, 22, SC, SE options) | No addition |
| 1160 | SARGENT XC Large Format Interchangeable Plastic Disposable Construction Core | No addition |
| 1163 | SARGENT XC Large Format Interchangeable Core Cylinder - Includes masterkeying charges | \$77.00 |
| 1164 | SARGENT XC Large Format Interchangeable Construction Core Cylinder | \$77.00 |
| 1170 | Small Format interchangeable disposable construction core - to accept 7 Pin XC permanent core | No addition |
| 11727P | Small Format interchangeable keyed construction core - to accept 7 Pin XC permanent core | \$69.00 |
| 11737P | Small Format interchangeable core - to accept 7 pin XC permanent core | \$69.00 / cyl. |
| 21▲† | SARGENT Construction Key System (lost ball) Standard on all new systems established since 5/1/96 | \$16.00 / cyl. |
| 22▲† | SARGENT Construction Key System (split key) To be used on pre-established split key systems only | \$32.00 / cyl. |
| 23 | Locksets with flat 4-7/8" ANSI strike | No addition |
| 31 | Thick Doors - Extended Lip Required - Specify Length C to E - Cylinders - IMPORTANT- See catalog 7800/8200 option page for cylinder limitations - Below charges DO NOT include additional charges for special cylinder requirements Doors up to 2-1/2" thick - lock centered Doors 2-5/8" to 6" thick OR doors 1-3/4" thick w/max 1" paneling one side. For example: Specify 1-3/4" door with panel (Side) on inside or outside | No addition Non Keyed function \$50.00 Keyed function \$100.00 |
| 36 | 6 Lobe security head screws | \$23.00 |
| 37 | Spanner head screws | \$16.00 |
| 60 | SARGENT Large Format Interchangeable Plastic Disposable Construction Core | No addition |
| 63 | SARGENT Large Format Interchangeable core cylinder, includes master keying charges | \$77.00 / cyl. |
| 64 | SARGENT Large Format Interchangeable Construction Core Cylinder | \$77.00 |
| 6573▲† | Small Format 6-Pin Uncombined Core (Refer to CK-12) | \$59.00 / cyl. |
| 65737P▲† | Small Format 7-Pin Uncombined Core (Refer to CK-12) | \$59.00 / cyl. |
| 68 | 8200 Line furnished with lever handle outside x knob inside (Excludes SLD Detention Knob) | Defaults to 8200 Lever Lock Price |
| 69 | 8200 Line furnished with lever handle inside x knob outside (Excludes SLD Detention Knob) | Defaults to 8200 Lever Lock Price |
| 70▲† | Small Format interchangeable disposable plastic construction core | No addition |
| 72▲† | Small Format Interchangeable 6-pin construction core (7-pin with 11 option) | \$69.00 |
| 73▲† | Small Format interchangeable core 6-pin Includes MK and GMK keying charges | \$69.00 / cyl |
| 737P▲† | Small Format interchangeable core 7-pin (refer to CK-12 for available keyways) Includes MK and GMK keying charges | \$69.00 / cyl |
| 75 | Tactile Warning - Milled Inside Lever (Not available with A lever) | \$72.00 |
| 76 | Tactile Warning - Milled Outside Lever (Not available with A lever) | \$72.00 |
| 77 | Tactile Warning - Milled Outside and Inside Lever (Not available with A lever) | \$144.00 |
| 81▲† | Cylinder to accept Keso (83) and Keso F1 (F183) removable core – no core provided | No addition |
| F182† | SARGENT Keso Security Cylinder – patented – new key systems | \$84.00 / cyl. |
| F183▲† | SARGENT Keso Security Removable Core Cylinder – patented – new key systems | \$120.00 / cyl. |
| 82† | SARGENT Keso Security Cylinder (For existing systems only) | \$84.00 / cyl. |
| 83▲† | SARGENT Keso Security Removable Core Cylinder (For existing systems only) | \$120.00 cyl. |
| 84▲† | SARGENT Keso Security Removable Construction Core Cylinder | See CK-18 |
| 85 | Tactile Warning - Abrasive Coating on Inside Lever | \$45.00 |
| 86 | Tactile Warning - Abrasive Coating on Outside Lever | \$45.00 |
| 87 | Tactile Warning - Abrasive Coating on Outside & Inside Lever | \$90.00 |
| AV | Anti Vandal Pull Trim (available in 32D finish), (Not available with 8270, 8271, 8272, 8273 functions) | \$212.00 |
| BR | SARGENT Bump Resistant Cylinders (N/A w/10, 22, 30, 60, 63, 64, 70, 72, 73, 737P, KESO, SC, & SE options) | \$23.00 /cyl. |
| DG1 | Patented Degree DG1 Key System | No Addition |
| DG160 | Hardware prepared for DG1-6300 Lg. Format IC cores, supplied with temporary plastic construction cores | No addition |
| DG163 | Patented Degree DG1 Large Format Interchangeable Core Cylinder - Includes master keying charges | \$77.00 |
| DG164 | Hardware prepared for DG1-6300 Lg. Format IC cores, supplied with temporary keyed construction cores | \$77.00 |
| DG2 | Patented Degree DG2 Key System incorporating a locking sidebar | \$58.00/cyl. |
| DG260 | Hardware prepared for DG2-6300 Lg. Format IC cores, supplied with temporary plastic construction cores | No addition |
| DG263 | Patented Degree DG2 Large Format Interchangeable Core Cylinder - Includes master keying charges | \$135.00 |
| DG264 | Hardware prepared for DG2-6300 Lg. Format IC cores, supplied with temporary keyed construction cores | \$77.00 |
| DG3 | Patented Degree DG3 Key System incorporating a locking sidebar and UL437 listed | \$82.00/cyl. |
| DG360 | Hardware prepared for DG3-6300 Lg. Format IC cores, supplied with temporary plastic construction cores | No addition |
| DG363 | Patented Degree DG3 Large Format Interchangeable Core Cylinder - Includes master keying charges | \$159.00 |
| DG364 | Hardware prepared for DG3-6300 Lg. Format IC cores, supplied with temporary keyed construction cores | \$77.00 |
| DX | Deadbolt Monitoring (not available with 50, 74) | \$182.00 |
| LB | Extra large thumbturn | \$16.00 |
| LC | Less Cylinder | -\$89.00/cyl. |
| LX | Latchbolt Monitor – available with all non-deadbolt functions; not available with DX option | \$185.00 |
| OBS | Open Back Strike | \$73.00 |
| RX | Request to Exit | \$190.00 |
| SC▲† | Schlage "C" Keyway cylinder, (Number 41 Cylinder Only, 0 bitted) | No addition |
| SE▲† | Schlage "E" Keyway cylinder, (Number 41 Cylinder Only, 0 bitted) | No addition |
| SG | MicroShield® – an antimicrobial powder coat finish | \$67.00 |
| TL | SARGuide™ – Illuminated escutcheon – refer to catalog for function limitations – not available w/RX & DX option | \$214.00 |
| WBS | Wrought Box Strike | No addition |

NOTES: ▲ Options not avail. with a standard 50 function lockout cylinder. † Not avail. with 60, 63, 64 options

| | | |
|-----|--|---------|
| CPC | Clear Powder Coat over 26D/32D – 8205 x WTL x RH x 32D x CPC All orders will continue to be handled as a "special" when CPC is ordered. | \$62.00 |
|-----|--|---------|

WT Escutcheon
• A-B-E-F-J-L-P-W Levers



| Function | | Finish | |
|---|------------------------------------|------------------|--|
| | | 10BE/26D/BSP/WSP | 03/04/09/10/10B/10BL/14/15/20D/26/32/32D |
| Single Cyl | | | |
| 8204 | Storeroom or Closet | | |
| 8205 | Office or Entry | | |
| 8237 | Classroom | \$945.00 | \$969.00 |
| 8255 | Office or Entry | | |
| 8206 | Storeroom or Service | | |
| 8231 | Utility | | |
| 8236 | Closet | | |
| 8256 | Office or Inner Entry | \$968.00 | \$992.00 |
| 8257, 8258, 8267 | Institutional Privacy | | |
| 8289 | Holdback | | |
| 8291 | All Purpose Holdback | | |
| Single Cyl With Deadbolt | | | |
| 8224 | Room Door | | |
| 8225 | Dormitory or Exit | | |
| 8227 | Closet or Storeroom | | |
| 8228, 8230 | Dummy Trim Deadlock | | |
| 8235 | Storeroom | \$997.00 | \$1,021.00 |
| 8243 | Apartment Corridor | | |
| 8245 | Dormitory or Exit | | |
| 8247 | Front Door or Apartment Corridor | | |
| 8251 | Storeroom Deadbolt | | |
| 8250 | Hotel Guest Lock | \$1,035.00 | \$1,059.00 |
| Double Cyl No Deadbolt | | | |
| 8216 | Apartment or Exit or Public Toilet | | |
| 8217 | Asylum or Institutional | | |
| 8238 | Classroom Security Intruder | \$1,046.00 | \$1,070.00 |
| 8259 | School Security | | |
| 8290 | Classroom Security Holdback | | |
| 8292 | All Purpose Holdback | | |
| Double Cyl With Deadbolt | | | |
| 8226 | Store Door | | |
| 8229 | Dummy Trim Deadlock | | |
| 8239, 8240 | Classroom Security Intruder | | |
| 8241 | Classroom Security | \$1,069.00 | \$1,093.00 |
| 8246 | Dormitory or Exit | | |
| 8248 | Store Door | | |
| 8249 | Security Deadbolt | | |
| 8252 | Institutional | | |
| Electro Mechanical Single Cyl – Specify 12V or 24V | | | |
| 8270-12V / 8270-24V | Fail Safe | \$1,141.00 | \$1,165.00 |
| 8271-12V / 8271-24V | Fail Secure | | |
| Electro Mechanical Double Cyl – Specify 12V or 24V | | | |
| 8272-12V / 8272-24V | Fail Safe | \$1,198.00 | \$1,222.00 |
| 8273-12V / 8273-24V | Fail Secure | | |
| Non Keyed | | | |
| 8213 | Communication or Exit | \$779.00 | \$803.00 |
| 8215 | Passage or Closet | | |
| 8265 | Privacy Bedroom or Bath (Latch) | \$878.00 | \$902.00 |
| 8266, 8268 | Privacy Bedroom or Bath (Deadbolt) | \$935.00 | \$959.00 |
| 8293* | Single Dummy Trim | \$302.00 | \$314.00 |
| 8294 | Double Dummy Trim | \$599.00 | \$623.00 |
| 8295 | Single Dummy Trim w/Lockbody | \$397.00 | \$409.00 |
| 8296 | Double Dummy Trim w/Lockbody | \$696.00 | \$720.00 |
| 8297 | Double Dummy w/Active Trim | \$779.00 | \$803.00 |

* "A" Lever Only – Specify hand and if for inside or outside of door, when ordering.

ML-24 MORTISE LOCKS

SARGENT®

ASSA ABLOY

OPTIONS

USA & Canada Prices Effective June 3, 2019

| Options | Description | Price |
|---------------|--|---|
| 1▲ | 8200 Line with 1-1/16" wide front for 1-3/8" doors. | \$58.00 |
| 3 | Stainless steel hub (not available with 8289, 8291 & 8292 functions) | \$63.00 |
| 10▲ | SARGENT Signature Key System | \$58.00 / cyl. |
| 11†▲ | SARGENT XC Key System (not available w/10, KESO, SC, SE) | No addition |
| 1160 | SARGENT XC Large Format Interchangeable Plastic Disposable Construction Core | No addition |
| 1163 | SARGENT XC Large Format Interchangeable Core Cylinder - Includes masterkeying charges | \$77.00 |
| 1164 | SARGENT XC Large Format Interchangeable Construction Core Cylinder | \$77.00 |
| 1170 | Small Format interchangeable disposable construction core - to accept 7 Pin XC permanent core | No addition |
| 11727P | Small Format interchangeable keyed construction core - to accept 7 Pin XC permanent core | \$69.00 |
| 11737P | Small Format interchangeable core - to accept 7 pin XC permanent core | \$69.00 /cyl. |
| 21▲† | SARGENT Construction Key System (lost ball) Standard on all new systems established since 5/1/96 | \$16.00 / cyl. |
| 22▲† | SARGENT Construction Key System (split key) To be used on pre-established split key systems only | \$32.00 / cyl. |
| 23 | Locksets with flat 4 7/8" ANSI strike | No addition |
| 31 | Thick Doors - Extended Lip Required - Specify Length C to E IMPORTANT: See 7800/8200 Catalog Option Page for Cylinder Limits – DOES NOT include additional Charges for Special Cylinder Requirements Doors up to 2-1/2" thick - lock centered • Doors 2-5/8" to 6" thick OR doors 1-3/4" thick w/max 1" paneling one side. For example: Specify 1-3/4" door with panel (Side) on inside or outside | No addition Non Keyed function \$50.00 Keyed function \$100.00 |
| 36 | 6 Lobe security head screws | \$23.00 |
| 37 | Spanner head screws | \$16.00 |
| 60 | SARGENT Large Format Interchangeable Plastic Disposable Construction Core | No addition |
| 63 | SARGENT Large Format Interchangeable core cylinder, includes master keying charges | \$77.00 / cyl |
| 64 | SARGENT Large Format Interchangeable Construction Core Cylinder | \$77.00 |
| 6573▲† | Small Format 6-Pin Uncombined Core (Refer to CK-12) | \$59.00 / cyl. |
| 65737P▲† | Small Format 7-Pin Uncombined Core (Refer to CK-12) | \$59.00 / cyl. |
| 68 | 8200 Line furnished with lever handle outside x knob inside (Excludes SLD Detention Knob) | Defaults to 8200 Lever Lock Price |
| 69 | 8200 Line furnished with lever handle inside x knob outside (Excludes SLD Detention Knob) | Defaults to 8200 Lever Lock Price |
| 70▲† | Small Format interchangeable disposable plastic construction core | No addition |
| 72▲† | Small Format interchangeable 6-Pin construction core | \$69.00 |
| 73▲† | Small Format interchangeable core 6-pin Includes MK and GMK keying charges | \$69.00 / cyl |
| 737P▲† | Small Format interchangeable core 7-pin (refer to CK-12 for available keyways) Includes MK and GMK keying charges | \$69.00 / cyl |
| 75 | Tactile Warning - Milled Inside Lever | \$72.00 |
| 76 | Tactile Warning - Milled Outside Lever | \$72.00 |
| 77 | Tactile Warning - Milled Outside and Inside Lever | \$144.00 |
| 81▲† | Cylinder to accept Keso (83) and Keso F1 (F183) removable core – no core provided | No addition |
| F182† | SARGENT Keso Security Cylinder – patented – new key systems | \$84.00 / cyl. |
| F183▲† | SARGENT Keso Security Removable Core Cylinder – patented – new key systems | \$120.00 / cyl. |
| 82† | SARGENT Keso Security Cylinder (For existing systems only) | \$84.00 / cyl. |
| 83▲† | SARGENT Keso Security Removable Core Cylinder (For existing systems only) | \$120.00 / cyl. |
| 84▲† | SARGENT Keso Security Removable Construction Core Cylinder | See CK-18 |
| 85 | Tactile Warning - Abrasive Coating on Inside Lever | \$45.00 |
| 86 | Tactile Warning - Abrasive Coating on Outside Lever | \$45.00 |
| 87 | Tactile Warning - Abrasive Coating on Outside & Inside Lever | \$90.00 |
| AV | Anti Vandal Pull Trim (available in 32D finish), (Not available with 8270, 8271, 8272, 8273 functions) | \$212.00 |
| BR | SARGENT Bump Resistant Cylinders (N/A w/10, 22, 30, 60, 63, 64, 70, 72, 73, 737P, KESO, SC, & SE options) | \$23.00 /cyl. |
| DG1 | Patented Degree DG1 Key System | No Addition |
| DG160 | Hardware prepared for DG1-6300 Lg. Format IC cores, supplied with temporary plastic construction cores | No addition |
| DG163 | Patented Degree DG1 Large Format Interchangeable Core Cylinder - Includes master keying charges | \$77.00 |
| DG164 | Hardware prepared for DG1-6300 Lg. Format IC cores, supplied with temporary keyed construction cores | \$77.00 |
| DG2 | Patented Degree DG2 Key System incorporating a locking sidebar | \$58.00/cyl. |
| DG260 | Hardware prepared for DG2-6300 Lg. Format IC cores, supplied with temporary plastic construction cores | No addition |
| DG263 | Patented Degree DG2 Large Format Interchangeable Core Cylinder - Includes master keying charges | \$135.00 |
| DG264 | Hardware prepared for DG2-6300 Lg. Format IC cores, supplied with temporary keyed construction cores | \$77.00 |
| DG3 | Patented Degree DG3 Key System incorporating a locking sidebar and UL437 listed | \$82.00/cyl. |
| DG360 | Hardware prepared for DG3-6300 Lg. Format IC cores, supplied with temporary plastic construction cores | No addition |
| DG363 | Patented Degree DG3 Large Format Interchangeable Core Cylinder - Includes master keying charges | \$159.00 |
| DG364 | Hardware prepared for DG3-6300 Lg. Format IC cores, supplied with temporary keyed construction cores | \$77.00 |
| IDP | Integrated Door Position Switch | \$100.00 |
| LB | Extra large thumbturn | \$16.00 |
| LC | Less Cylinder | -\$89.00/cyl. |
| OBS | Open Back Strike | \$73.00 |
| PHR | Deadbolt Privacy Function (available w/deadbolt function only) | \$100.00 |
| R01 | Mercury and Lenel compatible 1KΩ/2KΩ resistance supervision | \$100.00 |
| R03 | Software House compatible 1KΩ/2KΩ resistance supervision | \$100.00 |
| R04 | AMAG compatible 4-state supervision | \$100.00 |
| SC▲† | Schlage "C" Keyway cylinder, (Number 41 Cylinder Only, 0 bitting) | No addition |
| SE▲† | Schlage "E" Keyway cylinder, (Number 41 Cylinder Only, 0 bitting) | No addition |
| SG | MicroShield® – an antimicrobial powder coat finish | \$67.00 |
| WBS | Wrought Box Strike | No addition |
| NOTES: | ▲ Options not avail. with a standard 50 function lockout cylinder. † Not avail. with 60, 63, 64 options | |
| CPC | Clear Powder Coat over 26D/32D – NAC-82280-24V x W1A x RH x 32D x CPC All orders will continue to be handled as a "special" when CPC is ordered. | \$62.00 |

USA & Canada
Prices Effective
June 3, 2019

WT Escutcheon
• A-B-E-F-J-L-P-W Levers



WTA



WTL



WTJ

| NAC 8200 Electrified Mortise Locks with High Security Monitoring | | | | 10BE/26D/ BSP/WSP | 03/04/09/10/ 10B/10BL/14/15/ 20D/26/32/32D |
|--|----------------|------------------------|--------------------------------------|----------------------|--|
| Option | Function | Trim - Proximity Entry | Description | | |
| NAC | 82270-12V/-24V | Rose x Lever Design | Fail Safe w/Cylinder Override | \$1,316.00 | \$1,340.00 |
| NAC | 82271-12V/-24V | Rose x Lever Design | Fail Secure w/Cylinder Override | | |
| NAC | 82280-12V/-24V | Rose x Lever Design | Fail Safe w/Deadbolt w/Cyl.Override | \$1,391.00 | \$1,415.00 |
| NAC | 82281-12V/-24V | Rose x Lever Design | Fail Secure w/D.bolt w/Cyl.Override | | |
| NAC | 82274-12V/-24V | Rose x Lever Design | Fail Safe - No Cylinder | \$1,261.00 | \$1,285.00 |
| NAC | 82275-12V/-24V | Rose x Lever Design | Fail Secure - No Cylinder | | |
| NAC | 82284-12V/-24V | Rose x Lever Design | Fail Safe w/Deadbolt - No Cylinder | \$1,336.00 | \$1,360.00 |
| NAC | 82285-12V/-24V | Rose x Lever Design | Fail Secure w/Deadbolt - No Cylinder | | |

Note: Consult catalog for ordering information.
Specify hand and voltage (12v or 24v) when ordering

ML-26 MORTISE LOCKS

SARGENT®

OPTIONS

ASSA ABLOY

USA & Canada Prices Effective June 3, 2019

| Options | Description | Price |
|---------|---|--|
| 3 | Stainless steel hub (not available with 8289, 8291 & 8292 functions) | \$63.00 |
| 10▲ | SARGENT Signature Key System | \$58.00 / cyl. |
| 11▲ | SARGENT XC Key System (not available with 10, 22, SC, SE options) | No addition |
| 21▲ | SARGENT Construction Key System (lost ball) Standard on all new systems established since 5/1/96 | \$16.00 / cyl. |
| 22▲ | SARGENT Construction Key System (split key) To be used on pre-established split key systems only | \$32.00 / cyl. |
| 23 | Locksets with flat 4-7/8" ANSI strike | No addition |
| 31 | Thick Doors - Extended Lip Required - Specify Length C to E - Cylinders - IMPORTANT- See catalog 7800/8200 option page for cylinder limitations - Below charges DO NOT include additional charges for special cylinder requirements | |
| | Doors up to 2-1/2" thick - lock centered | No addition |
| | Doors 2-5/8" to 6" thick OR doors 1-3/4" thick w/max 1" paneling one side. For example: Specify 1-3/4" door with panel (Side) on inside or outside | Non Keyed function \$50.00 Keyed function \$100.00 |
| 36 | 6 Lobe security head screws | \$23.00 |
| 68 | 8200 Line furnished with lever handle outside x knob inside (Excludes SLD Detention Knob) | Defaults to 8200 Lever Lock Price |
| 69 | 8200 Line furnished with lever handle inside x knob outside (Excludes SLD Detention Knob) | Defaults to 8200 Lever Lock Price |
| 75 | Tactile Warning - Milled Inside Lever (Not available with A lever) | \$72.00 |
| 76 | Tactile Warning - Milled Outside Lever (Not available with A lever) | \$72.00 |
| 77 | Tactile Warning - Milled Outside and Inside Lever (Not available with A lever) | \$144.00 |
| F182 | SARGENT Keso Security Cylinder – patented – new key systems | \$84.00 cyl. |
| 82 | SARGENT KESO Security Cylinder (For existing systems only) | \$84.00 cyl. |
| 85 | Tactile Warning - Abrasive Coating on Inside Lever | \$45.00 |
| 86 | Tactile Warning - Abrasive Coating on Outside Lever | \$45.00 |
| 87 | Tactile Warning - Abrasive Coating on Outside & Inside Lever | \$90.00 |
| BR | SARGENT Bump Resistant Cylinders (N/A w/10, 22, 30, 60, 63, 64, 70, 72, 73, 737P, KESO, SC, & SE options) | \$23.00 /cyl. |
| DX | Deadbolt Monitoring (not available with 74) | \$182.00 |
| LB | Extra large thumbturn | \$16.00 |
| LC | Less Cylinder | -\$89.00/cyl. |
| LX | Latchbolt Monitor – available with all non-deadbolt functions; not available with DX option | \$185.00 |
| OBS | Open Back Strike | \$73.00 |
| SC▲ | Schlage "C" Keyway cylinder, (Number 41 Cylinder Only, 0 bitted) | No addition |
| SE▲ | Schlage "E" Keyway cylinder, (Number 41 Cylinder Only, 0 bitted) | No addition |
| SG | MicroShield® – an antimicrobial powder coat finish | \$67.00 |
| WBS | Wrought Box Strike | No addition |

NOTES: ▲ Options not available with a standard 50 function lockout cylinder.

| | | |
|-----|--|---------|
| CPC | Clear Powder Coat over 26D/32D – 8205 x LSL x RH x 32D x CPC All orders will continue to be handled as a "special" when CPC is ordered. | \$62.00 |
|-----|--|---------|



LS

USA & Canada Prices Effective June 3, 2019

LS Escutcheon • A-B-E-F-J-L-P-W Levers

| Function | | Finish | |
|---------------------------------|------------------------------------|------------------|---|
| | | 10BE/26D/BSP/WSP | 03/04/09/10/10B/10BL/14/15/20D/26/32/32 |
| Single Cyl | | | |
| 8204 | Storeroom or Closet | | |
| 8205 | Office or Entry | \$1,592.00 | \$1,616.00 |
| 8237 | Classroom | | |
| 8255 | Office or Entry | | |
| <hr/> | | | |
| 8206 | Storeroom or Service | | |
| 8231 | Utility | | |
| 8236 | Closet | | |
| 8256 | Office or Inner Entry | \$1,618.00 | \$1,642.00 |
| 8257, 8258, 8267 | Institutional Privacy | | |
| 8289 | Holdback | | |
| 8291 | All Purpose Holdback | | |
| <hr/> | | | |
| Single Cyl With Deadbolt | | | |
| 8224 | Room Door | | |
| 8225 | Dormitory or Exit | | |
| 8235 | Storeroom | | |
| 8227 | Closet or Storeroom | \$1,640.00 | \$1,664.00 |
| 8228, 8230 | Dummy Trim Deadlock | | |
| 8243 | Apartment Corridor | | |
| 8245 | Dormitory or Exit | | |
| 8247 | Front Door or Apartment Corridor | | |
| 8251 | Storeroom Deadbot | | |
| 8250 | Hotel Guest Lock | \$1,682.00 | \$1,706.00 |
| <hr/> | | | |
| Double Cyl No Deadbolt | | | |
| 8216 | Apartment or Exit or Public Toilet | | |
| 8217 | Asylum or Institutional | | |
| 8238 | Classroom Security Intruder | \$1,696.00 | \$1,720.00 |
| 8259 | School Security | | |
| 8290 | Classroom Security Holdback | | |
| 8292 | All Purpose Holdback | | |
| <hr/> | | | |
| Double Cyl With Deadbolt | | | |
| 8226 | Store Door | | |
| 8229 | Dummy Trim Deadlock | | |
| 8239, 8240 | Classroom Security Intruder | | |
| 8241 | Classroom Security | \$1,713.00 | \$1,737.00 |
| 8246 | Dormitory or Exit | | |
| 8248 | Store Door | | |
| 8249 | Security Deadbot | | |
| 8252 | Institutional | | |
| <hr/> | | | |
| Non Keyed | | | |
| 8213 | Communication or Exit | \$1,407.00 | \$1,431.00 |
| 8215 | Passage or Closet | | |
| 8265 | Privacy Bedroom or Bath (Latch) | \$1,515.00 | \$1,539.00 |
| 8266, 8268 | Privacy Bedroom or Bath (Deadbolt) | \$1,581.00 | \$1,605.00 |
| 8293 | Single Dummy Trim | \$524.00 | \$536.00 |
| 8294 | Double Dummy Trim | \$1,051.00 | \$1,075.00 |
| 8295 | Single Dummy Trim w/Lockbody | \$671.00 | \$683.00 |
| 8296 | Double Dummy Trim w/Lockbody | \$1,198.00 | \$1,222.00 |
| 8297 | Double Dummy w/Active Trim | \$1,320.00 | \$1,344.00 |

NOTE

Available with size #41 cylinder only. Cylinder lip sits behind escutcheon.

Consult factory for 70, 71, 72, and 73 functions.

Locks supplied standard with 4 spanner head screws on escutcheon only.

ML-28 8200 FREEWHEELING

SARGENT®

ASSA ABLOY

OPTIONS

USA & Canada Prices Effective June 3, 2019

| Options | Description | Price |
|---------|---|-----------------|
| 1- | 8200 Line with 1-1/16" wide front for 1-3/8" door | \$58.00 |
| 3 | Stainless steel hub (not available with 8289, 8291 & 8292 functions) | \$63.00 |
| 10 | Signature Key System | \$58.00 /cyl. |
| 11† | SARGENT XC Key System (not available with 10, 22, SC, SE options) | No addition |
| 1160 | SARGENT XC Large Format Interchangeable Plastic Disposable Construction Core | No addition |
| 1163 | SARGENT XC Large Format Interchangeable Core Cylinder - Includes masterkeying charges | \$77.00 |
| 1164 | SARGENT XC Large Format Interchangeable Construction Core Cylinder | \$77.00 |
| 1170 | Small Format interchangeable disposable construction core - to accept 7 Pin XC permanent core | No addition |
| 11727P | Small Format interchangeable keyed construction core - to accept 7 Pin XC permanent core | 69 |
| 11737P | Small Format interchangeable core - to accept 7 pin XC permanent core | \$69.00 |
| 21† | SARGENT Construction Keying System (Lost Ball) standard on all new systems est. since 5/1/96 | \$16.00 /cyl. |
| 22† | SARGENT Construction Keying System (Split Key) to be used on pre-established split keys only | \$32.00 /cyl. |
| 23 | Locksets with flat 4-7/8" ANSI strike | No addition |
| 31◆ | Doors over 1-3/4" thick | Consult Factory |
| 36 | 6 Lobe security screws | \$23.00 |
| 37 | Spanner head security screws | \$16.00 |
| 60 | SARGENT Large Format Interchangeable Plastic Disposable Construction Core | No addition |
| 63 | SARGENT Large Format Interchangeable core cylinder, includes master keying charges | \$77.00 /cyl. |
| 64 | SARGENT Large Format Interchangeable Construction Core Cylinder | \$77.00 |
| 70 | Small Format interchangeable disposable plastic construction core (Not available with J lever) | No addition |
| 72 | Small Format interchangeable 6-Pin construction core (not available with J lever) | \$69.00 |
| 73 | Small Format interchangeable core 6-pin Includes MK and GMK keying charges (Not available with J lever) | \$69.00 |
| 737P | Small Format interchangeable core 7-pin (refer to CK-12 for available keyways) - Includes MK and GMK keying charges (Not available with J lever) | \$69.00 |
| 75 | Tactile Warning - Milled Inside Lever (Not available with A lever) | \$72.00 |
| 76 | Tactile Warning - Milled Outside Lever (Not available with A lever) | \$72.00 |
| 77 | Tactile Warning - Milled Outside and Inside Lever (Not available with A lever) | \$144.00 |
| F182† | SARGENT Keso Security Cylinder – patented – new key systems | \$84.00 /cyl. |
| 82† | SARGENT KESO Security Cylinder (For existing systems only) | \$84.00 /cyl. |
| 85 | Tactile Warning - Abrasive coating on inside lever | \$45.00 |
| 86 | Tactile Warning - Abrasive coating on outside lever | \$45.00 |
| 87 | Tactile Warning - Abrasive coating on both levers | \$90.00 |
| BR | SARGENT Bump Resistant Cylinders (N/A w/10, 22, 30, 60, 63, 64, 70, 72, 73, 737P, KESO, SC, & SE options) | \$23.00 /cyl. |
| DG1 | Patented Degree DG1 Key System | No Addition |
| DG160 | Hardware prepared for DG1-6300 Lg. Format IC cores, supplied with temporary plastic construction cores | No addition |
| DG163 | Patented Degree DG1 Large Format Interchangeable Core Cylinder - Includes master keying charges | \$77.00 |
| DG164 | Hardware prepared for DG1-6300 Lg. Format IC cores, supplied with temporary keyed construction cores | \$77.00 |
| DG2 | Patented Degree DG2 Key System incorporating a locking sidebar | \$58.00/cyl. |
| DG260 | Hardware prepared for DG2-6300 Lg. Format IC cores, supplied with temporary plastic construction cores | No addition |
| DG263 | Patented Degree DG2 Large Format Interchangeable Core Cylinder - Includes master keying charges | \$135.00 |
| DG264 | Hardware prepared for DG2-6300 Lg. Format IC cores, supplied with temporary keyed construction cores | \$77.00 |
| DG3 | Patented Degree DG3 Key System incorporating a locking sidebar and UL437 listed | \$82.00/cyl. |
| DG360 | Hardware prepared for DG3-6300 Lg. Format IC cores, supplied with temporary plastic construction cores | No addition |
| DG363 | Patented Degree DG3 Large Format Interchangeable Core Cylinder - Includes master keying charges | \$159.00 |
| DG364 | Hardware prepared for DG3-6300 Lg. Format IC cores, supplied with temporary keyed construction cores | \$77.00 |
| LB | Extra large thumbturn | \$16.00 |
| LC | Less Cylinder | -\$89.00/cyl. |
| OBS | Open Back Strike | \$73.00 |
| SG | MicroShield® – an antimicrobial powder coat finish | \$67.00 |
| WBS | Wrought Box Strike | No addition |

NOTES: † Not available with 60, 63, 64 options. ◆ Consult factory for availability of cylinders for thick doors.

| | | |
|-----|--|---------|
| CPC | Clear Powder Coat over 26D/32D – 8205 x FEL x RH x 32D x CPC All orders will continue to be handled as a "special" when CPC is ordered. | \$62.00 |
|-----|--|---------|

USA & Canada Prices Effective June 3, 2019

Trim is handed — Please specify hand when ordering.

FE Escutcheon • A-B-E-F-J-L-P-W Levers



| Function | | Finish | |
|---------------------------------|------------------------------------|------------------|-----------------------------------|
| | | 10BE/26D/BSP/WSP | 03/04/09/10/10B/10BL/14/15/20D/26 |
| Single Cyl | | | |
| 8204 | Storeroom or Closet | | |
| 8205 | Office or Entry | \$1,145.00 | \$1,169.00 |
| 8237 | Classroom | | |
| 8231 | Utility | | |
| 8236 | Closet | \$1,169.00 | \$1,193.00 |
| Single Cyl With Deadbolt | | | |
| 8224 | Room Door | | |
| 8225 | Dormitory or Exit | \$1,195.00 | \$1,219.00 |
| 8235 | Storeroom | | |
| 8251 | Storeroom Deadbolt | | |
| Double Cyl With Deadbolt | | | |
| 8216 | Apartment or Exit or Public Toilet | | |
| 8217 | Asylum or Institutional | \$1,242.00 | \$1,266.00 |
| 8238 | Classroom Security Intruder | | |
| Double Cyl With Deadbolt | | | |
| 8226 | Store Door | \$1,263.00 | \$1,287.00 |
| 8239, 8240 | Classroom Security Intruder | | |
| Non Keyed | | | |
| 8265 | Privacy Bedroom or Bath (Latch) | \$1,073.00 | \$1,097.00 |
| 8266 | Privacy Bedroom or Bath (Deadbolt) | \$1,103.00 | \$1,127.00 |

ML-30 MORTISE LOCKS

SARGENT®

ASSA ABLOY

OPTIONS

USA & Canada Prices Effective June 3, 2019

| Options | Description | Price |
|----------|---|--|
| 1▲ | 8200 Line with 1-1/16" wide front for 1-3/8" doors. | \$58.00 |
| 3 | Stainless steel hub (not available with 8289, 8291 & 8292 functions) | \$63.00 |
| 10▲ | SARGENT Signature Key System | \$58.00/ cyl. |
| 11†▲ | SARGENT XC Key System (not available with 10, 22, SC, SE options) | No addition |
| 1160 | SARGENT XC Large Format Interchangeable Plastic Disposable Construction Core | No addition |
| 1163 | SARGENT XC Large Format Interchangeable Core Cylinder - Includes masterkeying charges | \$77.00 |
| 1164 | SARGENT XC Large Format Interchangeable Construction Core Cylinder | \$77.00 |
| 1170 | Small Format interchangeable disposable construction core - to accept 7 Pin XC permanent core | No addition |
| 11727P | Small Format interchangeable keyed construction core - to accept 7 Pin XC permanent core | \$69.00 |
| 11737P | Small Format interchangeable core - to accept 7 pin XC permanent core | \$69.00/cyl. |
| 21▲† | SARGENT Construction Key System (lost ball) Standard on all new systems established since 5/1/96 | \$16.00/ cyl. |
| 22▲† | SARGENT Construction Key System (split key) To be used on pre-established split key systems only | \$32.00/ cyl. |
| 31 | Thick Doors - Extended Lip Required - Specify Length C to E - Cylinders - IMPORTANT- See catalog 7800/8200 option page for cylinder limitations - Below charges DO NOT include additional charges for special cylinder requirements | |
| | Doors up to 2-1/2" thick - lock centered | No addition |
| | Doors 2-5/8" to 6" thick OR doors 1-3/4" thick w/max 1" paneling one side. For example: Specify 1-3/4" door with panel (Side) on inside or outside | Non Keyed function \$50.00 Keyed function \$100.00 |
| 36 | 6 Lobe security head screws | \$23.00 |
| 37 | Spanner head screws | \$16.00 |
| 49 | Visual Status Indicator - Available with 30, 36, 37 function - Rose Trims CR, E, L, LN, O, TR - Available with 26, 29, 38, 39 40, 41 functions - Rose Trim 8200 LN | \$92.00 |
| 49 | Occupancy Indicator with emergency Release - Available with 65, 66, 68 functions; Rose Trims 7800 CR, E, L, LN, O, TR | \$92.00 |
| 50 | Secured Indicator Rose- doors 1-5/8" to 2-1/4" thick- Avail.w/ 24,25,26,28,29,30,36,37,38,39,40,41,43,45,50,51,52,67 functs. | \$62.00 |
| 60 | SARGENT Large Format Interchangeable Plastic Disposable Construction Core | No addition |
| 63 | SARGENT Large Format Interchangeable core cylinder, includes master keying charges | \$77.00/ cyl. |
| 64 | SARGENT Large Format Interchangeable Construction Core Cylinder | \$77.00 |
| 6573▲† | Small Format 6-Pin Uncombined Core (Refer to CK-12) | \$59.00/ cyl. |
| 65737P▲† | Small Format 7-Pin Uncombined Core (Refer to CK-12) | \$59.00/ cyl. |
| 68 | 8200 Line furnished with lever handle outside x knob inside (Excludes SLD Detention Knob) | Defaults to 8200 Lever Lock Price |
| 69 | 8200 Line furnished with lever handle inside x knob outside (Excludes SLD Detention Knob) | Defaults to 8200 Lever Lock Price |
| 70▲† | Small Format Interchangeable disposable plastic construction core | No addition |
| 72▲† | Small Format interchangeable core 6-pin Includes MK and GMK keying charges | \$69.00 |
| 73▲† | Small Format interchangeable core 6-pin Includes MK and GMK keying charges | \$69.00/ cyl |
| 737P▲† | Small Format interchangeable core 7-pin (refer to CK-12 for available keyways) Includes MK and GMK keying charges | \$69.00 cyl |
| 74 | Lock case wrapped in lead - handling required (roses not available) | \$272.00 |
| 81▲† | Cylinder to accept Keso (83) and Keso F1 (F183) removable core - no core provided | No addition |
| F182† | SARGENT Keso Security Cylinder - patented - new key systems | \$84.00/ cyl. |
| F183▲† | SARGENT Keso Security Removable Core Cylinder - patented - new key systems | \$120.00/ cyl. |
| 82† | SARGENT Keso Security Cylinder (For existing systems only) | \$84.00/ cyl. |
| 83▲† | SARGENT Keso Security Removable Core Cylinder (For existing systems only) | \$120.00/ cyl. |
| 84▲† | SARGENT Keso Security Removable Construction Core Cylinder | See CK-18 |
| 85 | Tactile Warning - Abrasive coating on inside lever | \$45.00 |
| 86 | Tactile Warning - Abrasive coating on outside lever | \$45.00 |
| 87 | Tactile Warning - Abrasive coating on both levers | \$90.00 |
| AV | Anti Vandal Pull Trim (available in 32D finish), (Not available with 8270, 8271, 8272, 8273 functions) | \$212.00 |
| BR | SARGENT Bump Resistant Cylinders (N/A w/10, 22, 30, 60, 63, 64, 70, 72, 73, 737P, KESO, SC, SE) | \$23.00/cyl. |
| DX | Deadbolt Monitoring (not available with 50, 74) | \$182.00 |
| DG1 | Patented Degree DG1 Key System | No Addition |
| DG160 | Hardware prepared for DG1-6300 Lg. Format IC cores, supplied with temporary plastic construction cores | No addition |
| DG163 | Patented Degree DG1 Large Format Interchangeable Core Cylinder - Includes master keying charges | \$77.00 |
| DG164 | Hardware prepared for DG1-6300 Lg. Format IC cores, supplied with temporary keyed construction cores | \$77.00 |
| DG2 | Patented Degree DG2 Key System incorporating a locking sidebar | \$58.00/cyl. |
| DG260 | Hardware prepared for DG2-6300 Lg. Format IC cores, supplied with temporary plastic construction cores | No addition |
| DG263 | Patented Degree DG2 Large Format Interchangeable Core Cylinder - Includes master keying charges | \$135.00 |
| DG264 | Hardware prepared for DG2-6300 Lg. Format IC cores, supplied with temporary keyed construction cores | \$77.00 |
| DG3 | Patented Degree DG3 Key System incorporating a locking sidebar and UL437 listed | \$82.00/cyl. |
| DG360 | Hardware prepared for DG3-6300 Lg. Format IC cores, supplied with temporary plastic construction cores | No addition |
| DG363 | Patented Degree DG3 Large Format Interchangeable Core Cylinder - Includes master keying charges | \$159.00 |
| DG364 | Hardware prepared for DG3-6300 Lg. Format IC cores, supplied with temporary keyed construction cores | \$77.00 |
| LB | Extra large thumbturn | \$16.00 |
| LC | Less Cylinder | -\$89.00/cyl. |
| LX | Latchbolt Monitor - available with all non-deadbolt functions; not available with DX option | \$185.00 |
| OBS | Open Back Strike | \$73.00 |
| RX | Request to Exit | \$190.00 |
| SC▲† | Schlage "C" Keyway cylinder, (Number 41 Cylinder Only, 0 bitted) | No addition |
| SE▲† | Schlage "E" Keyway cylinder, (Number 41 Cylinder Only, 0 bitted) | No addition |
| SG | MicroShield® - an antimicrobial powder coat finish | \$67.00 |
| T1 | Decorative thumbturn; backplate matches rose design chosen | No Addition |
| T2 | Decorative square thumbturn; backplate matches rose design chosen | No Addition |
| T3 | Decorative cylinder thumbturn; backplate matches rose design chosen | No Addition |
| WBS | Wrought Box Strike | No addition |

NOTES: ▲ Options not avail. with a standard 50 function lockout cylinder. † Not avail. with 60, 63, 64 options

CPC Clear Powder Coat over 26D/32D - 8205 x TRY x RH x 32D x CPC \$62.00
All orders will continue to be handled as a "special" when CPC is ordered.



USA & Canada Prices Effective June 3, 2019

TR Rose - 2" Dia • CR Rose - 2-3/16" Dia • G-R-S-Y Levers

Note: hands required when ordering G-S-Y Levers

TRY shown.

| Function | | Finish | |
|---|------------------------------------|------------------|-----------------------------------|
| | | 10BE/26D/BSP/WSP | 03/04/09/10/10B/10BL/14/15/20D/26 |
| Single Cyl | | | |
| 8204 | Storeroom or Closet | | |
| 8205 | Office or Entry | | |
| 8237 | Classroom | \$1,006.00 | \$1,030.00 |
| 8255 | Office or Entry | | |
| 8206 | Storeroom or Service | | |
| 8231 | Utility | | |
| 8236 | Closet | | |
| 8256 | Office or Inner Entry | \$1,031.00 | \$1,055.00 |
| 8257, 8258, 8267 | Institutional Privacy | | |
| 8289 | Holdback | | |
| 8291 | All Purpose Holdback | | |
| Single Cyl With Deadbolt | | | |
| 8224 | Room Door | | |
| 8225 | Dormitory or Exit | | |
| 8227 | Closet or Storeroom | | |
| 8228, 8230 | Dummy Trim Deadlock | | |
| 8235 | Storeroom | \$1,060.00 | \$1,084.00 |
| 8243 | Apartment Corridor | | |
| 8245 | Dormitory or Exit | | |
| 8247 | Front Door or Apartment Corridor | | |
| 8251 | Storeroom Deadbolt | | |
| 8250 | Hotel Guest Lock | \$1,092.00 | \$1,116.00 |
| Double Cyl No Deadbolt | | | |
| 8216 | Apartment or Exit or Public Toilet | | |
| 8217 | Asylum or Institutional | | |
| 8238 | Classroom Security Intruder | \$1,108.00 | \$1,132.00 |
| 8259 | School Security | | |
| 8290 | Classroom Security Holdback | | |
| 8292 | All Purpose Holdback | | |
| Double Cyl With Deadbolt | | | |
| 8226 | Store Door | | |
| 8229 | Dummy Trim Deadlock | | |
| 8239, 8240 | Classroom Security Intruder | | |
| 8241 | Classroom Security | \$1,129.00 | \$1,153.00 |
| 8246 | Dormitory or Exit | | |
| 8248 | Store Door | | |
| 8249 | Security Deadbolt | | |
| 8252 | Institutional | | |
| Electro Mechanical Single Cyl – Specify 12V or 24V | | | |
| 8270-12V / 8270-24V | Fail Safe | \$1,202.00 | \$1,226.00 |
| 8271-12V / 8271-24V | Fail Secure | | |
| Electro Mechanical Double Cyl – Specify 12V or 24V | | | |
| 8272-12V / 8272-24V | Fail Safe | \$1,259.00 | \$1,283.00 |
| 8273-12V / 8273-24V | Fail Secure | | |
| Non Keyed | | | |
| 8213 | Communication or Exit | \$806.00 | \$830.00 |
| 8215 | Passage or Closet | | |
| 8265 | Privacy Bedroom or Bath (Latch) | \$887.00 | \$911.00 |
| 8266, 8268 | Privacy Bedroom or Bath (Deadbolt) | \$983.00 | \$1,007.00 |
| 8293 | Single Dummy Trim | \$333.00 | \$345.00 |
| 8294 | Double Dummy Trim | \$665.00 | \$689.00 |
| 8295 | Single Dummy Trim w/Lockbody | \$427.00 | \$439.00 |
| 8296 | Double Dummy Trim w/Lockbody | \$763.00 | \$787.00 |
| 8297 | Double Dummy w/Active Trim | \$846.00 | \$870.00 |

ML-32 MORTISE LOCKS

SARGENT®

ASSA ABLOY

OPTIONS

USA & Canada Prices Effective June 3, 2019

| Options | Description | Price |
|---|--|--|
| 1▲ | 8200 Line with 1-1/16" wide front for 1-3/8" doors. | \$58.00 |
| 3 | Stainless steel hub (not available with 8289, 8291 & 8292 functions) | \$63.00 |
| 10▲ | SARGENT Signature Key System | \$58.00/ cyl. |
| 11†▲ | SARGENT XC Key System (not available w/10, KESO, SC, SE) | No addition |
| 1160 | SARGENT XC Large Format Interchangeable Plastic Disposable Construction Core | No addition |
| 1163 | SARGENT XC Large Format Interchangeable Core Cylinder - Includes masterkeying charges | \$77.00 |
| 1164 | SARGENT XC Large Format Interchangeable Construction Core Cylinder | \$77.00 |
| 1170 | Small Format interchangeable disposable construction core - to accept 7 Pin XC permanent core | No addition |
| 11727P | Small Format interchangeable keyed construction core - to accept 7 Pin XC permanent core | \$69.00 |
| 11737P | Small Format interchangeable core - to accept 7 pin XC permanent core | \$69.00/cyl. |
| 21▲† | SARGENT Construction Key System (lost ball) Standard on all new systems established since 5/1/96 | \$16.00/ cyl. |
| 22▲† | SARGENT Construction Key System (split key) To be used on pre-established split key systems only | \$32.00/ cyl. |
| 23 | Locksets with flat 4 7/8" ANSI strike | No addition |
| 31 | Thick Doors - Extended Lip Required - Specify Length C to E IMPORTANT: See 7800/8200 Catalog Option Page for Cylinder Limits - DOES NOT include additional Charges for Special Cylinder Requirements | No addition |
| | Doors up to 2-1/2" thick - lock centered • Doors 2-5/8" to 6" thick OR doors 1-3/4" thick w/max 1" paneling one side. For example: Specify 1-3/4" door with panel (Side) on inside or outside | Non Keyed function \$50.00 Keyed function \$100.00 |
| 36 | 6 Lobe security head screws | \$23.00 |
| 37 | Spanner head screws | \$16.00 |
| 49 | Visual Status Indicator - Available with 30, 36, 37 function - Rose Trims CR, E, L, LN, O, TR - Available with 26, 29, 38, 39 40, 41 functions - Rose Trim 8200 LN | \$92.00 |
| 49 | Occupancy Indicator with emergency Release - Available with 65, 66, 68 functions; Rose Trims 7800 CR, E, L, LN, O, TR | \$92.00 |
| 50 | Secured Indicator Rose- doors 1-5/8" to 2-1/4" thick- Avail.w/24,25,26,28,29,30,36,37,38,39,40,41,43,45,50,51,52,57,58,67 functions | \$62.00 |
| 60 | SARGENT Large Format Interchangeable Plastic Disposable Construction Core | No addition |
| 63 | SARGENT Large Format Interchangeable core cylinder, includes master keying charges | \$77.00/ cyl |
| 64 | SARGENT Large Format Interchangeable Construction Core Cylinder | \$77.00 |
| 6573▲† | Small Format 6-Pin Uncombined Core (Refer to CK-12) | \$59.00/ cyl. |
| 65737P▲† | Small Format 7-Pin Uncombined Core (Refer to CK-12) | \$59.00/ cyl. |
| 70▲† | Small Format interchangeable disposable plastic construction core | No addition |
| 72▲† | Small Format interchangeable 6-Pin construction core | \$69.00 |
| 73▲† | Small Format interchangeable core 6-pin Includes MK and GMK keying charges | \$69.00/ cyl |
| 737P▲† | Small Format interchangeable core 7-pin (refer to CK-12 for available keyways) Includes MK and GMK keying charges | \$69.00/ cyl |
| 81▲† | Cylinder to accept Keso (83) and Keso F1 (F183) removable core - no core provided | No addition |
| F182† | SARGENT Keso Security Cylinder - patented - new key systems | \$84.00/ cyl. |
| F183▲† | SARGENT Keso Security Removable Core Cylinder - patented - new key systems | \$120.00/ cyl. |
| 82† | SARGENT Keso Security Cylinder (For existing systems only) | \$84.00/ cyl. |
| 83▲† | SARGENT Keso Security Removable Core Cylinder (For existing systems only) | \$120.00/ cyl. |
| 84▲† | SARGENT Keso Security Removable Construction Core Cylinder | See CK-18 |
| 85 | Tactile Warning - Abrasive Coating on Inside Lever | \$45.00 |
| 86 | Tactile Warning - Abrasive Coating on Outside Lever | \$45.00 |
| 87 | Tactile Warning - Abrasive Coating on Outside & Inside Lever | \$90.00 |
| AV | Anti Vandal Pull Trim (available in 32D finish) (Not available with 8270, 8271, 8272, 8273 functions) | \$212.00 |
| BR | SARGENT Bump Resistant Cylinders (N/A w/10, 22, 30, 60, 63, 64, 70, 72, 73, 737P, KESO, SC, & SE options) | \$23.00/cyl. |
| DG1 | Patented Degree DG1 Key System | No Addition |
| DG160 | Hardware prepared for DG1-6300 Lg. Format IC cores, supplied with temporary plastic construction cores | No addition |
| DG163 | Patented Degree DG1 Large Format Interchangeable Core Cylinder - Includes master keying charges | \$77.00 |
| DG164 | Hardware prepared for DG1-6300 Lg. Format IC cores, supplied with temporary keyed construction cores | \$77.00 |
| DG2 | Patented Degree DG2 Key System incorporating a locking sidebar | \$58.00/cyl. |
| DG260 | Hardware prepared for DG2-6300 Lg. Format IC cores, supplied with temporary plastic construction cores | No addition |
| DG263 | Patented Degree DG2 Large Format Interchangeable Core Cylinder - Includes master keying charges | \$135.00 |
| DG264 | Hardware prepared for DG2-6300 Lg. Format IC cores, supplied with temporary keyed construction cores | \$77.00 |
| DG3 | Patented Degree DG3 Key System incorporating a locking sidebar and UL437 listed | \$82.00/cyl. |
| DG360 | Hardware prepared for DG3-6300 Lg. Format IC cores, supplied with temporary plastic construction cores | No addition |
| DG363 | Patented Degree DG3 Large Format Interchangeable Core Cylinder - Includes master keying charges | \$159.00 |
| DG364 | Hardware prepared for DG3-6300 Lg. Format IC cores, supplied with temporary keyed construction cores | \$77.00 |
| IDP | Integrated Door Position Switch | \$100.00 |
| LB | Extra large thumbturn | \$16.00 |
| LC | Less Cylinder | -\$89.00/cyl. |
| OBS | Open Back Strike | \$73.00 |
| PHR | Deadbolt Privacy Function (available w/deadbolt function only) | \$100.00 |
| R01 | Mercury and Lenel compatible 1KΩ/2KΩ resistance supervision | \$100.00 |
| R03 | Software House compatible 1KΩ/2KΩ resistance supervision | \$100.00 |
| R04 | AMAG compatible 4-state supervision | \$100.00 |
| SC▲† | Schlage "C" Keyway cylinder, (Number 41 Cylinder Only, 0 bitted) | No addition |
| SE▲† | Schlage "E" Keyway cylinder, (Number 41 Cylinder Only, 0 bitted) | No addition |
| SG | MicroShield® - an antimicrobial powder coat finish | \$67.00 |
| WBS | Wrought Box Strike | No addition |
| NOTES: ▲ Options not avail. with a standard 50 function lockout cylinder. † Not avail. with 60, 63, 64 options | | |
| CPC | Clear Powder Coat over 26D/32D - NAC-82280-24V x TRY x RH x 32D x CPC All orders will continue to be handled as a "special" when CPC is ordered. | \$62.00 |

SARGENT®

ASSA ABLOY

ML-33 MORTISE LOCKS

NAC 8200 SERIES

USA & Canada Prices Effective June 3, 2019

TR Rose - 2" Dia • CR Rose - 2-3/16" Dia • G-R-S-Y Levers



Note: hands required when ordering -G-S-Y Levers

TRY shown.

| NAC 8200 Electrified Mortise Locks with High Security Monitoring | | | | 10BE/26D/ BSP/WSP | 03/04/09/10/ 10B/10BL/14/15/ 20D/26 |
|--|----------------|------------------------|--------------------------------------|----------------------|---|
| Option | Function | Trim - Proximity Entry | Description | | |
| NAC | 82270-12V/-24V | Rose x Lever Design | Fail Safe w/Cylinder Override | \$1,377.00 | \$1,401.00 |
| NAC | 82271-12V/-24V | Rose x Lever Design | Fail Secure w/Cylinder Override | | |
| NAC | 82280-12V/-24V | Rose x Lever Design | Fail Safe w/Deadbolt w/Cyl.Override | \$1,452.00 | \$1,476.00 |
| NAC | 82281-12V/-24V | Rose x Lever Design | Fail Secure w/D.bolt w/Cyl.Override | | |
| NAC | 82274-12V/-24V | Rose x Lever Design | Fail Safe - No Cylinder | \$1,322.00 | \$1,346.00 |
| NAC | 82275-12V/-24V | Rose x Lever Design | Fail Secure - No Cylinder | | |
| NAC | 82284-12V/-24V | Rose x Lever Design | Fail Safe w/Deadbolt - No Cylinder | \$1,397.00 | \$1,421.00 |
| NAC | 82285-12V/-24V | Rose x Lever Design | Fail Secure w/Deadbolt - No Cylinder | | |

Note: Consult catalog for ordering information.

Specify hand and voltage (12v or 24v) when ordering

ML-34 MORTISE LOCKS

SARGENT®

ASSA ABLOY

OPTIONS

USA & Canada Prices Effective June 3, 2019

| Options | Description | Price |
|----------|--|--|
| 1▲ | 8200 Line with 1-1/16" wide front for 1-3/8" doors. | \$58.00 |
| 3 | Stainless steel hub (not available with 8289, 8291 & 8292 functions) | \$63.00 |
| 10▲ | SARGENT Signature Key System | \$58.00 / cyl. |
| 11†▲ | SARGENT XC Key System (not available with 10, 22, SC, SE options) | No addition |
| 1160 | SARGENT XC Large Format Interchangeable Plastic Disposable Construction Core | No addition |
| 1163 | SARGENT XC Large Format Interchangeable Core Cylinder - Includes masterkeying charges | \$77.00 |
| 1164 | SARGENT XC Large Format Interchangeable Construction Core Cylinder | \$77.00 |
| 1170 | Small Format interchangeable disposable construction core - to accept 7 Pin XC permanent core | No addition |
| 11727P | Small Format interchangeable keyed construction core - to accept 7 Pin XC permanent core | \$69.00 |
| 11737P | Small Format interchangeable core - to accept 7 pin XC permanent core | \$69.00 / cyl. |
| 21▲† | SARGENT Construction Key System (lost ball) Standard on all new systems established since 5/1/96 | \$16.00 / cyl. |
| 22▲† | SARGENT Construction Key System (split key) To be used on pre-established split key systems only | \$32.00 / cyl. |
| 23 | Locksets with flat 4-7/8" ANSI strike | No addition |
| 31 | Thick Doors - Extended Lip Required - Specify Length C to E - Cylinders - IMPORTANT- See catalog 7800/8200 option page for cylinder limitations - Below charges DO NOT include additional charges for special cylinder requirements Doors up to 2-1/2" thick - lock centered Doors 2-5/8" to 6" thick OR doors 1-3/4" thick w/max 1" paneling one side. For example: Specify 1-3/4" door with panel (Side) on inside or outside | No addition Non Keyed function \$50.00 Keyed function \$100.00 |
| 36 | 6 Lobe security head screws | \$23.00 |
| 37 | Spanner head screws | \$16.00 |
| 60 | SARGENT Large Format Interchangeable Plastic Disposable Construction Core | No addition |
| 63 | SARGENT Large Format Interchangeable core cylinder, includes master keying charges | \$77.00 / cyl. |
| 64 | SARGENT Large Format Interchangeable Construction Core Cylinder | \$77.00 |
| 6573▲† | Small Format 6-Pin Uncombined Core (Refer to CK-12) | \$59.00 / cyl. |
| 65737P▲† | Small Format 7-Pin Uncombined Core (Refer to CK-12) | \$59.00 / cyl. |
| 68 | 8200 Line furnished with lever handle outside x knob inside (Excludes SLD Detention Knob) | Defaults to 8200 Lever Lock Price |
| 69 | 8200 Line furnished with lever handle inside x knob outside (Excludes SLD Detention Knob) | Defaults to 8200 Lever Lock Price |
| 70▲† | Small Format Interchangeable disposable plastic construction core | No addition |
| 72▲† | Small Format interchangeable 6-pin construction core (7-pin with 11 option) | \$69.00 |
| 73▲† | Small Format interchangeable core 6-pin Includes MK and GMK keying charges | \$69.00 / cyl |
| 737P▲† | Small Format interchangeable core 7-pin (refer to CK-12 for available keyways) Includes MK and GMK keying charges | \$69.00 / cyl |
| 81▲† | Cylinder to accept Keso (83) and Keso F1 (F183) removable core – no core provided | No addition |
| F182† | SARGENT Keso Security Cylinder – patented – new key systems | \$84.00 / cyl. |
| F183▲† | SARGENT Keso Security Removable Core Cylinder – patented – new key systems | \$120.00 / cyl. |
| 82† | SARGENT Keso Security Cylinder (For existing systems only) | \$84.00 / cyl. |
| 83▲† | SARGENT Keso Security Removable Core Cylinder (For existing systems only) | \$120.00 / cyl. |
| 84▲† | SARGENT Keso Security Removable Construction Core Cylinder | See CK-18 |
| 85 | Tactile Warning - Abrasive coating on inside lever | \$45.00 |
| 86 | Tactile Warning - Abrasive coating on outside lever | \$45.00 |
| 87 | Tactile Warning - Abrasive coating on both levers | \$90.00 |
| AV | Anti Vandal Pull Trim (available in 32D finish), (Not available with 8270, 8271, 8272, 8273 functions) | \$212.00 |
| BR | SARGENT Bump Resistant Cylinders (N/A w/10, 22, 30, 60, 63, 64, 70, 72, 73, 737P, KESO, SC, & SE options) | \$23.00 /cyl. |
| DG1 | Patented Degree DG1 Key System | No Addition |
| DG160 | Hardware prepared for DG1-6300 Lg. Format IC cores, supplied with temporary plastic construction cores | No addition |
| DG163 | Patented Degree DG1 Large Format Interchangeable Core Cylinder - Includes master keying charges | \$77.00 |
| DG164 | Hardware prepared for DG1-6300 Lg. Format IC cores, supplied with temporary keyed construction cores | \$77.00 |
| DG2 | Patented Degree DG2 Key System incorporating a locking sidebar | \$58.00/cyl. |
| DG260 | Hardware prepared for DG2-6300 Lg. Format IC cores, supplied with temporary plastic construction cores | No addition |
| DG263 | Patented Degree DG2 Large Format Interchangeable Core Cylinder - Includes master keying charges | \$135.00 |
| DG264 | Hardware prepared for DG2-6300 Lg. Format IC cores, supplied with temporary keyed construction cores | \$77.00 |
| DG3 | Patented Degree DG3 Key System incorporating a locking sidebar and UL437 listed | \$82.00/cyl. |
| DG360 | Hardware prepared for DG3-6300 Lg. Format IC cores, supplied with temporary plastic construction cores | No addition |
| DG363 | Patented Degree DG3 Large Format Interchangeable Core Cylinder - Includes master keying charges | \$159.00 |
| DG364 | Hardware prepared for DG3-6300 Lg. Format IC cores, supplied with temporary keyed construction cores | \$77.00 |
| DX | Deadbolt Monitoring (not available with 50, 74) | \$182.00 |
| LB | Extra large thumbturn | \$16.00 |
| LC | Less Cylinder | -\$89.00/cyl. |
| LX | Latchbolt Monitor – available with all non-deadbolt functions; not available with DX option | \$185.00 |
| OBS | Open Back Strike | \$73.00 |
| RX | Request to Exit | \$190.00 |
| SC▲† | Schlage "C" Keyway cylinder, (Number 41 Cylinder Only, 0 bitted) | No addition |
| SE▲† | Schlage "E" Keyway cylinder, (Number 41 Cylinder Only, 0 bitted) | No addition |
| SG | MicroShield® – an antimicrobial powder coat finish | \$67.00 |
| WBS | Wrought Box Strike | No addition |

NOTES: ▲ Options not avail. with a standard 50 function lockout cylinder. † Not avail. with 60, 63, 64 options

| | | |
|-----|--|---------|
| CPC | Clear Powder Coat over 26D/32D – 8205 x TEG x RH x 32D x CPC All orders will continue to be handled as a "special" when CPC is ordered. | \$62.00 |
|-----|--|---------|



USA & Canada Prices Effective June 3, 2019

TE Escutcheon • CE Escutcheon • G-R-S-Y Levers

Note: hands required when ordering G-S-Y Levers

TEG Shown.

| Function | | Finish | |
|---|------------------------------------|------------------|-----------------------------------|
| Single Cyl | | 10BE/26D/BSP/WSP | 03/04/09/10/10B/10BL/14/15/20D/26 |
| 8204 | Storeroom or Closet | | |
| 8205 | Office or Entry | \$1,054.00 | \$1,078.00 |
| 8237 | Classroom | | |
| 8255 | Office or Entry | | |
| 8206 | Storeroom or Service | | |
| 8231 | Utility | | |
| 8236 | Closet | | |
| 8256 | Office or Inner Entry | \$1,075.00 | \$1,099.00 |
| 8257, 8258, 8267 | Institutional Privacy | | |
| 8289 | Holdback | | |
| 8291 | All Purpose Holdback | | |
| Single Cyl With Deadbolt | | | |
| 8224 | Room Door | | |
| 8225 | Dormitory or Exit | | |
| 8227 | Closet or Storeroom | | |
| 8228, 8230 | Dummy Trim Deadlock | \$1,104.00 | \$1,128.00 |
| 8235 | Storeroom | | |
| 8243 | Apartment Corridor | | |
| 8245 | Dormitory or Exit | | |
| 8247 | Front Door or Apartment Corridor | | |
| 8251 | Storeroom Deadbolt | | |
| 8250 | Hotel Guest Lock | \$1,145.00 | \$1,169.00 |
| Double Cyl No Deadbolt | | | |
| 8216 | Apartment or Exit or Public Toilet | | |
| 8217 | Asylum or Institutional | | |
| 8238 | Classroom Security Intruder | \$1,154.00 | \$1,178.00 |
| 8259 | School Security | | |
| 8290 | Classroom Security Holdback | | |
| 8292 | All Purpose Holdback | | |
| Double Cyl With Deadbolt | | | |
| 8226 | Store Door | | |
| 8229 | Dummy Trim Deadlock | | |
| 8239, 8240 | Classroom Security Intruder | \$1,179.00 | \$1,203.00 |
| 8241 | Classroom Security | | |
| 8246 | Dormitory or Exit | | |
| 8248 | Store Door | | |
| 8249 | Security Deadbolt | | |
| 8252 | Institutional | | |
| Electro Mechanical Single Cyl – Specify 12V or 24V | | | |
| 8270-12V / 8270-24V | Fail Safe | \$1,250.00 | \$1,274.00 |
| 8271-12V / 8271-24V | Fail Secure | | |
| Electro Mechanical Double Cyl – Specify 12V or 24V | | | |
| 8272-12V / 8272-24V | Fail Safe | \$1,307.00 | \$1,331.00 |
| 8273-12V / 8273-24V | Fail Secure | | |
| Non Keyed | | | |
| 8213 | Communication or Exit | \$843.00 | \$867.00 |
| 8215 | Passage or Closet | | |
| 8265 | Privacy Bedroom or Bath (Latch) | \$942.00 | \$966.00 |
| 8266, 8268 | Privacy Bedroom or Bath (Deadbolt) | \$997.00 | \$1,021.00 |
| 8293 | Single Dummy Trim | \$348.00 | \$360.00 |
| 8294 | Double Dummy Trim | \$695.00 | \$719.00 |
| 8295 | Single Dummy Trim w/Lockbody | \$444.00 | \$456.00 |
| 8296 | Double Dummy Trim w/Lockbody | \$792.00 | \$816.00 |
| 8297 | Double Dummy w/Active Trim | \$874.00 | \$898.00 |

ML-36 MORTISE LOCKS

SARGENT®

ASSA ABLOY

OPTION

USA & Canada Prices Effective June 3, 2019

| Options | Description | Price |
|----------|--|---|
| 1▲ | 8200 Line with 1-1/16" wide front for 1-3/8" doors. | \$58.00 |
| 3 | Stainless steel hub (not available with 8289, 8291 & 8292 functions) | \$63.00 |
| 10▲ | SARGENT Signature Key System | \$58.00 / cyl. |
| 11†▲ | SARGENT XC Key System (not available w/10, KESO, SC, SE) | No addition |
| 1160 | SARGENT XC Large Format Interchangeable Plastic Disposable Construction Core | No addition |
| 1163 | SARGENT XC Large Format Interchangeable Core Cylinder - Includes masterkeying charges | \$77.00 |
| 1164 | SARGENT XC Large Format Interchangeable Construction Core Cylinder | \$77.00 |
| 1170 | Small Format interchangeable disposable construction core - to accept 7 Pin XC permanent core | No addition |
| 11727P | Small Format interchangeable keyed construction core - to accept 7 Pin XC permanent core | \$69.00 |
| 11737P | Small Format interchangeable core - to accept 7 pin XC permanent core | \$69.00 / cyl. |
| 21▲† | SARGENT Construction Key System (lost ball) Standard on all new systems established since 5/1/96 | \$16.00 / cyl. |
| 22▲† | SARGENT Construction Key System (split key) To be used on pre-established split key systems only | \$32.00 / cyl. |
| 23 | Locksets with flat 4 7/8" ANSI strike | No addition |
| 31 | Thick Doors - Extended Lip Required - Specify Length C to E IMPORTANT: See 7800/8200 Catalog Option Page for Cylinder Limits - DOES NOT include additional Charges for Special Cylinder Requirements | No addition |
| | Doors up to 2-1/2" thick - lock centered • Doors 2-5/8" to 6" thick OR doors 1-3/4" thick w/max 1" paneling one side. For example: Specify 1-3/4" door with panel (Side) on inside or outside | Non Keyed function \$50.00 Keyed function \$100.00 |
| 36 | 6 Lobe security head screws | \$23.00 |
| 37 | Spanner head screws | \$16.00 |
| 49 | Visual Status Indicator - Available with 30, 36, 37 function - Rose Trims CR, E, L, LN, O, TR - Available with 26, 29, 38, 39 40, 41 functions - Rose Trim 8200 LN | \$92.00 |
| 49 | Occupancy Indicator with emergency Release - Available with 65, 66, 68 functions; Rose Trims 7800 CR, E, L, LN, O, TR | \$92.00 |
| 50 | Secured Indicator Rose- doors 1-5/8" to 2-1/4" thick- Avail.w/24,25,26,28,29,30,36,37,38,39,40,41,43,45,50,51,52,57,58,67 functions | \$62.00 |
| 60 | SARGENT Large Format Interchangeable Plastic Disposable Construction Core | No addition |
| 63 | SARGENT Large Format Interchangeable core cylinder, includes master keying charges | \$77.00 / cyl |
| 64 | SARGENT Large Format Interchangeable Construction Core Cylinder | \$77.00 |
| 6573▲† | Small Format 6-Pin Uncombined Core (Refer to CK-12) | \$59.00 / cyl. |
| 65737P▲† | Small Format 7-Pin Uncombined Core (Refer to CK-12) | \$59.00 / cyl. |
| 68 | 8200 Line furnished with lever handle outside x knob inside (Excludes SLD Detention Knob) | Defaults to 8200 Lever Lock Price |
| 69 | 8200 Line furnished with lever handle inside x knob outside (Excludes SLD Detention Knob) | Defaults to 8200 Lever Lock Price |
| 70▲† | Small Format interchangeable disposable plastic construction core | No addition |
| 72▲† | Small Format interchangeable 6-Pin construction core | \$69.00 |
| 73▲† | Small Format interchangeable core 6-pin Includes MK and GMK keying charges | \$69.00 / cyl |
| 737P▲† | Small Format interchangeable core 7-pin (refer to CK-12 for available keyways) Includes MK and GMK keying charges | \$69.00 / cyl |
| 81▲† | Cylinder to accept Keso (83) and Keso F1 (F183) removable core - no core provided | No addition |
| F182† | SARGENT Keso Security Cylinder - patented - new key systems | \$84.00 / cyl. |
| F183▲† | SARGENT Keso Security Removable Core Cylinder - patented - new key systems | \$120.00 / cyl. |
| 82† | SARGENT Keso Security Cylinder (For existing systems only) | \$84.00 / cyl. |
| 83▲† | SARGENT Keso Security Removable Core Cylinder (For existing systems only) | \$120.00 / cyl. |
| 84▲† | SARGENT Keso Security Removable Construction Core Cylinder | See CK-18 |
| 85 | Tactile Warning - Abrasive Coating on Inside Lever | \$45.00 |
| 86 | Tactile Warning - Abrasive Coating on Outside Lever | \$45.00 |
| 87 | Tactile Warning - Abrasive Coating on Outside & Inside Lever | \$90.00 |
| AV | Anti Vandal Pull Trim (available in 32D finish), (Not available with 8270, 8271, 8272, 8273 functions) | \$212.00 |
| BR | SARGENT Bump Resistant Cylinders (N/A w/10, 22, 30, 60, 63, 64, 70, 72, 73, 737P, KESO, SC, & SE options) | \$23.00 /cyl. |
| DG1 | Patented Degree DG1 Key System | No Addition |
| DG160 | Hardware prepared for DG1-6300 Lg. Format IC cores, supplied with temporary plastic construction cores | No addition |
| DG163 | Patented Degree DG1 Large Format Interchangeable Core Cylinder - Includes master keying charges | \$77.00 |
| DG164 | Hardware prepared for DG1-6300 Lg. Format IC cores, supplied with temporary keyed construction cores | \$77.00 |
| DG2 | Patented Degree DG2 Key System incorporating a locking sidebar | \$58.00/cyl. |
| DG260 | Hardware prepared for DG2-6300 Lg. Format IC cores, supplied with temporary plastic construction cores | No addition |
| DG263 | Patented Degree DG2 Large Format Interchangeable Core Cylinder - Includes master keying charges | \$135.00 |
| DG264 | Hardware prepared for DG2-6300 Lg. Format IC cores, supplied with temporary keyed construction cores | \$77.00 |
| DG3 | Patented Degree DG3 Key System incorporating a locking sidebar and UL437 listed | \$82.00/cyl. |
| DG360 | Hardware prepared for DG3-6300 Lg. Format IC cores, supplied with temporary plastic construction cores | No addition |
| DG363 | Patented Degree DG3 Large Format Interchangeable Core Cylinder - Includes master keying charges | \$159.00 |
| DG364 | Hardware prepared for DG3-6300 Lg. Format IC cores, supplied with temporary keyed construction cores | \$77.00 |
| IDP | Integrated Door Position Switch | \$100.00 |
| LB | Extra large thumbturn | \$16.00 |
| LC | Less Cylinder | -\$89.00/cyl. |
| OBS | Open Back Strike | \$73.00 |
| PHR | Deadbolt Privacy Function (available w/deadbolt function only) | \$100.00 |
| R01 | Mercury and Lenel compatible 1KΩ/2KΩ resistance supervision | \$100.00 |
| R03 | Software House compatible 1KΩ/2KΩ resistance supervision | \$100.00 |
| R04 | AMAG compatible 4-state supervision | \$100.00 |
| SC▲† | Schlage "C" Keyway cylinder, (Number 41 Cylinder Only, 0 bitted) | No addition |
| SE▲† | Schlage "E" Keyway cylinder, (Number 41 Cylinder Only, 0 bitted) | No addition |
| SG | MicroShield® - an antimicrobial powder coat finish | \$67.00 |
| WBS | Wrought Box Strike | No addition |

NOTES: ▲ Options not avail. with a standard 50 function lockout cylinder. † Not avail. with 60, 63, 64 options
CPC Clear Powder Coat over 26D/32D - NAC-82280-24V x TEG x RH x 32D x CPC \$62.00
All orders will continue to be handled as a "special" when CPC is ordered.

SARGENT®

ASSA ABLOY

ML-37 MORTISE LOCKS

NAC 8200 SERIES

USA & Canada Prices Effective June 3, 2019

TE Escutcheon • CE Escutcheon • G-R-S-Y Levers

Note: hands required when ordering -G-S-Y Levers



TEG Shown.

| NAC 8200 Electrified Mortise Locks with High Security Monitoring | | | | 10BE/26D/ BSP/WSP | 03/04/09/10/ 10B/10BL/14/15/ 20D/26 |
|--|----------------|------------------------|--------------------------------------|----------------------|---|
| Option | Function | Trim - Proximity Entry | Description | | |
| NAC | 82270-12V/-24V | Rose x Lever Design | Fail Safe w/Cylinder Override | \$1,425.00 | \$1,449.00 |
| NAC | 82271-12V/-24V | Rose x Lever Design | Fail Secure w/Cylinder Override | | |
| NAC | 82280-12V/-24V | Rose x Lever Design | Fail Safe w/Deadbolt w/Cyl.Override | \$1,500.00 | \$1,524.00 |
| NAC | 82281-12V/-24V | Rose x Lever Design | Fail Secure w/D.bolt w/Cyl.Override | | |
| NAC | 82274-12V/-24V | Rose x Lever Design | Fail Safe - No Cylinder | \$1,370.00 | \$1,394.00 |
| NAC | 82275-12V/-24V | Rose x Lever Design | Fail Secure - No Cylinder | | |
| NAC | 82284-12V/-24V | Rose x Lever Design | Fail Safe w/Deadbolt - No Cylinder | \$1,445.00 | \$1,469.00 |
| NAC | 82285-12V/-24V | Rose x Lever Design | Fail Secure w/Deadbolt - No Cylinder | | |

Note: Consult catalog for ordering information.

Specify hand and voltage (12v or 24v) when ordering

ML-38 MORTISE LOCKS

SARGENT®

ASSA ABLOY

OPTION

USA & Canada Prices Effective June 3, 2019

| Options | Description | Price |
|----------|--|--|
| 1▲ | 8200 Line with 1-1/16" wide front for 1-3/8" doors. | \$58.00 |
| 3 | Stainless steel hub (not available with 8289, 8291 & 8292 functions) | \$63.00 |
| 10▲ | SARGENT Signature Key System | \$58.00 / cyl. |
| 11†▲ | SARGENT XC Key System (not available with 10, 22, SC, SE options) | No addition |
| 1160 | SARGENT XC Large Format Interchangeable Plastic Disposable Construction Core | No addition |
| 1163 | SARGENT XC Large Format Interchangeable Core Cylinder - Includes masterkeying charges | \$77.00 |
| 1164 | SARGENT XC Large Format Interchangeable Construction Core Cylinder | \$77.00 |
| 1170 | Small Format interchangeable disposable construction core - to accept 7 Pin XC permanent core | No addition |
| 11727P | Small Format interchangeable keyed construction core - to accept 7 Pin XC permanent core | \$69.00 |
| 11737P | Small Format interchangeable core - to accept 7 pin XC permanent core | \$69.00 /cyl. |
| 21▲† | SARGENT Construction Key System (lost ball) Standard on all new systems established since 5/1/96 | \$16.00 / cyl. |
| 22▲† | SARGENT Construction Key System (split key) To be used on pre-established split key systems only | \$32.00 / cyl. |
| 23 | Locksets with flat 4 7/8" ANSI strike | No addition |
| 31 | Thick Doors - Extended Lip Required - Specify Length C to E - Cylinders - IMPORTANT- See catalog 7800/8200 option page for cylinder limitations - Below charges DO NOT include additional charges for special cylinder requirements Doors up to 2-1/2" thick - lock centered Doors 2-5/8" to 6" thick OR doors 1-3/4" thick w/max 1" paneling one side. For example: Specify 1-3/4" door with panel (Side) on inside or outside | No addition Non Keyed function \$50.00 Keyed function \$100.00 |
| 49 | Visual Status Indicator - Available with 30, 36, 37 function - Rose Trims CR, E, L, LN, O, TR - Available with 26, 29, 38, 39 40, 41 functions - Rose Trim 8200 LN | \$92.00 |
| 49 | Occupancy Indicator with emergency Release - Available with 65, 66, 68 functions; Rose Trims 7800 CR, E, L, LN, O, TR | \$92.00 |
| 50 | Secured Indicator Rose- doors 1-5/8" to 2-1/4" thick- Avail.w/24,25,26,28,29,30,36,37,38,39,40,41,43,45,50,51,52,57,58,67 functions | \$62.00 |
| 60 | SARGENT Large Format Interchangeable Plastic Disposable Construction Core | No addition |
| 63 | SARGENT Large Format Interchangeable core cylinder, includes master keying charges | \$77.00 / cyl. |
| 64 | SARGENT Large Format Interchangeable Construction Core Cylinder | \$77.00 |
| 6573▲† | Small Format 6-Pin Uncombined Core (Refer to CK-12) | \$59.00 / cyl. |
| 65737P▲† | Small Format 7-Pin Uncombined Core (Refer to CK-12) | \$59.00 / cyl. |
| 68 | 8200 Line furnished with lever handle outside x knob inside (Excludes SLD Detention Knob) | Defaults to 8200 Lever Lock Price |
| 69 | 8200 Line furnished with lever handle inside x knob outside (Excludes SLD Detention Knob) | Defaults to 8200 Lever Lock Price |
| 70▲† | Small Format Interchangeable disposable plastic construction core | No addition |
| 72▲† | Small Format Interchangeable 6-pin construction core (7-pin with 11 option) | \$69.00 |
| 73▲† | Small Format 6-pin interchangeable core (refer to CK-8 for available keyways) | \$69.00 / cyl |
| 737P▲† | Small Format Interchangeable core (refer to CK 8 for available keyways) | \$69.00 / cyl |
| 74 | Lock case wrapped in lead - handing required (roses not available) | \$272.00 |
| 81▲† | Cylinder to accept Keso (83) and Keso F1 (F183) removable core - no core provided | No addition |
| F182† | SARGENT Keso Security Cylinder - patented - new key systems | \$84.00 / cyl. |
| F183▲† | SARGENT Keso Security Removable Core Cylinder - patented - new key systems | \$120.00 / cyl. |
| 82† | SARGENT Keso Security Cylinder (For existing systems only) | \$84.00 / cyl. |
| 83▲† | SARGENT Keso Security Removable Core Cylinder (For existing systems only) | \$120.00 / cyl. |
| 84▲† | SARGENT Keso Security Removable Construction Core Cylinder | See CK-18 |
| 85 | Tactile Warning - Abrasive coating on inside lever | \$45.00 |
| 86 | Tactile Warning - Abrasive coating on outside lever | \$45.00 |
| 87 | Tactile Warning - Abrasive coating on both levers | \$90.00 |
| AV | Anti Vandal Pull Trim (available in 32D finish), (Not available with 8270, 8271, 8272, 8273 functions) | \$212.00 |
| BR | SARGENT Bump Resistant Cylinders (N/A w/10, 22, 30, 60, 63, 64, 70, 72, 73, 737P, KESO, SC, & SE options) | \$23.00 /cyl. |
| DG1 | Patented Degree DG1 Key System | No Addition |
| DG160 | Hardware prepared for DG1-6300 Lg. Format IC cores, supplied with temporary plastic construction cores | No addition |
| DG163 | Patented Degree DG1 Large Format Interchangeable Core Cylinder - Includes master keying charges | \$77.00 |
| DG164 | Hardware prepared for DG1-6300 Lg. Format IC cores, supplied with temporary keyed construction cores | \$77.00 |
| DG2 | Patented Degree DG2 Key System incorporating a locking sidebar | \$58.00/cyl. |
| DG260 | Hardware prepared for DG2-6300 Lg. Format IC cores, supplied with temporary plastic construction cores | No addition |
| DG263 | Patented Degree DG2 Large Format Interchangeable Core Cylinder - Includes master keying charges | \$135.00 |
| DG264 | Hardware prepared for DG2-6300 Lg. Format IC cores, supplied with temporary keyed construction cores | \$77.00 |
| DG3 | Patented Degree DG3 Key System incorporating a locking sidebar and UL437 listed | \$82.00/cyl. |
| DG360 | Hardware prepared for DG3-6300 Lg. Format IC cores, supplied with temporary plastic construction cores | No addition |
| DG363 | Patented Degree DG3 Large Format Interchangeable Core Cylinder - Includes master keying charges | \$159.00 |
| DG364 | Hardware prepared for DG3-6300 Lg. Format IC cores, supplied with temporary keyed construction cores | \$77.00 |
| DX | Deadbolt Monitoring (not available with 50, 74) | \$182.00 |
| LC | Less Cylinder | -\$89.00/cyl. |
| LB | Extra large thumbturn | \$16.00 |
| LX | Latchbolt Monitor - available with all non-deadbolt functions; not available with DX option | \$185.00 |
| OBS | Open Back Strike | \$73.00 |
| RX | Request to Exit | \$190.00 |
| SC▲† | Schlage "C" Keyway cylinder, (Number 41 Cylinder Only, 0 bitted) | No addition |
| SE▲† | Schlage "E" Keyway cylinder, (Number 41 Cylinder Only, 0 bitted) | No addition |
| SG | MicroShield® - an antimicrobial powder coat finish | \$67.00 |
| T1 | Decorative thumbturn; backplate matches rose design chosen | No Addition |
| T2 | Decorative square thumbturn; backplate matches rose design chosen | No Addition |
| T3 | Decorative cylinder thumbturn; backplate matches rose design chosen | No Addition |
| WBS | Wrought Box Strike | No addition |

NOTES: ▲ Options not avail. with a standard 50 function lockout cylinder. † Not avail. with 60, 63, 64 options

| | | |
|-----|---|---------|
| CPC | Clear Powder Coat over 26D/32D - 8205 x CRH001 x RH x 32D x CPC All orders will continue to be handled as a "special" when CPC is ordered. | \$62.00 |
|-----|---|---------|

ASSA ABLOY

8200 STUDIO COLLECTION WOOSTER SQUARE

Rose Design:

CO (2-3/4")
CR (2-3/16")
LN (2")
O (2-3/4")
TO (2-3/4")
TR (2-3/16")
E2 (2-11/16")
E3 (2-1/16")
E4 (3-1/4")

Lever Design:

H001, H002



H001



H002

How to order:

21-8205 x E4H001 x RH x 10BE
Option 21
Function 8205
Rose E4
Lever H001
Hand RH
Finish 10BE

USA & Canada
Prices Effective
June 3, 2019

| Function | | Finish | |
|---|------------------------------------|------------------|--|
| | | 10BE/26D/BSP/WSP | 03/04/09/10/10B/10BL/14/15/20D/26/32/32D |
| Single Cyl | | | |
| 8204 | Storeroom or Closet | | |
| 8205 | Office or Entry | \$1,089.00 | \$1,113.00 |
| 8237 | Classroom | | |
| 8255 | Office or Entry | | |
| 8206 | Storeroom or Service | | |
| 8231 | Utility | | |
| 8236 | Closet | | |
| 8256 | Office or Inner Entry | \$1,111.00 | \$1,135.00 |
| 8257, 8258, 8267 | Institutional Privacy | | |
| 8289 | Holdback | | |
| 8291 | All Purpose Holdback | | |
| Single Cyl With Deadbolt | | | |
| 8224 | Room Door | | |
| 8225 | Dormitory or Exit | | |
| 8227 | Closet or Storeroom | | |
| 8228, 8230 | Dummy Trim Deadlock | \$1,137.00 | \$1,161.00 |
| 8235 | Storeroom | | |
| 8243 | Apartment Corridor | | |
| 8245 | Dormitory or Exit | | |
| 8247 | Front Door or Apartment Corridor | | |
| 8251 | Storeroom Deadbolt | | |
| 8250 | Hotel Guest Lock | \$1,174.00 | \$1,198.00 |
| Double Cyl No Deadbolt | | | |
| 8216 | Apartment or Exit or Public Toilet | | |
| 8217 | Asylum or Institutional | | |
| 8238 | Classroom Security Intruder | | |
| 8259 | School Security | \$1,184.00 | \$1,208.00 |
| 8290 | Classroom Security Holdback | | |
| 8292 | All Purpose Holdback | | |
| Double Cyl With Deadbolt | | | |
| 8226 | Store Door | | |
| 8229 | Dummy Trim Deadlock | | |
| 8239, 8240 | Classroom Security Intruder | | |
| 8241 | Classroom Security | \$1,206.00 | \$1,230.00 |
| 8246 | Dormitory or Exit | | |
| 8248 | Store Door | | |
| 8249 | Security Deadbolt | | |
| 8252 | Institutional | | |
| Electro Mechanical Single Cyl – Specify 12V or 24V | | | |
| 8270-12V / 8270-24V | Fail Safe | \$1,285.00 | \$1,309.00 |
| 8271-12V / 8271-24V | Fail Secure | | |
| Electro Mechanical Double Cyl – Specify 12V or 24V | | | |
| 8272-12V / 8272-24V | Fail Safe | \$1,342.00 | \$1,366.00 |
| 8273-12V / 8273-24V | Fail Secure | | |
| Non Keyed | | | |
| 8213 | Communication or Exit | \$936.00 | \$960.00 |
| 8215 | Passage or Closet | | |
| 8265 | Privacy Bedroom or Bath (Latch) | \$1,036.00 | \$1,060.00 |
| 8266, 8268 | Privacy Bedroom or Bath (Deadbolt) | \$1,070.00 | \$1,094.00 |
| 8293* | Single Dummy Trim | \$373.00 | \$397.00 |
| 8294 | Double Dummy Trim | \$766.00 | \$790.00 |
| 8295 | Single Dummy Trim w/Lockbody | \$463.00 | \$487.00 |
| 8296 | Double Dummy Trim w/Lockbody | \$856.00 | \$880.00 |
| 8297 | Double Dummy w/Active Trim | \$936.00 | \$960.00 |

ML-40 MORTISE LOCKS

SARGENT®

ASSA ABLOY

OPTION

USA & Canada Prices Effective June 3, 2019

| Options | Description | Price |
|----------|--|---|
| 1▲ | 8200 Line with 1-1/16" wide front for 1-3/8" doors. | \$58.00 |
| 3 | Stainless steel hub (not available with 8289, 8291 & 8292 functions) | \$63.00 |
| 10▲ | SARGENT Signature Key System | \$58.00 / cyl. |
| 11†▲ | SARGENT XC Key System (not available with 10, 22, SC, SE options) | No addition |
| 1160 | SARGENT XC Large Format Interchangeable Plastic Disposable Construction Core | No addition |
| 1163 | SARGENT XC Large Format Interchangeable Core Cylinder - Includes masterkeying charges | \$77.00 |
| 1164 | SARGENT XC Large Format Interchangeable Construction Core Cylinder | \$77.00 |
| 1170 | Small Format interchangeable disposable construction core - to accept 7 Pin XC permanent core | No addition |
| 11727P | Small Format interchangeable keyed construction core - to accept 7 Pin XC permanent core | \$69.00 |
| 11737P | Small Format interchangeable core - to accept 7 pin XC permanent core | \$69.00 /cyl. |
| 21▲† | SARGENT Construction Key System (lost ball) Standard on all new systems established since 5/1/96 | \$16.00 / cyl. |
| 22▲† | SARGENT Construction Key System (split key) To be used on pre-established split key systems only | \$32.00 / cyl. |
| 23 | Locksets with flat 4 7/8" ANSI strike | No addition |
| 31 | Thick Doors - Extended Lip Required - Specify Length C to E - Cylinders - IMPORTANT- See catalog 7800/8200 option page for cylinder limitations - Below charges DO NOT include additional charges for special cylinder requirements Doors up to 2-1/2" thick - lock centered Doors 2-5/8" to 6" thick OR doors 1-3/4" thick w/max 1" paneling one side. For example: Specify 1-3/4" door with panel (Side) on inside or outside | No addition Non Keyed function \$50.00 Keyed function \$100.00 |
| 49 | Visual Status Indicator - Available with 30, 36, 37 function - Rose Trims CR, E, L, LN, O, TR - Available with 26, 29, 38, 39 40, 41 functions - Rose Trim 8200 LN | \$92.00 |
| 49 | Occupancy Indicator with emergency Release - Available with 65, 66, 68 functions; Rose Trims 7800 CR, E, L, LN, O, TR | \$92.00 |
| 50 | Secured Indicator Rose- doors 1-5/8" to 2-1/4" thick- Avail.w/24,25,26,28,29,30,36,37,38,39,40,41,43,45,50,51,52,57,58,67 functions | \$62.00 |
| 60 | SARGENT Large Format Interchangeable Plastic Disposable Construction Core | No addition |
| 63 | SARGENT Large Format Interchangeable core cylinder, includes master keying charges | \$77.00 / cyl. |
| 64 | SARGENT Large Format Interchangeable Construction Core Cylinder | \$77.00 |
| 6573▲† | Small Format 6-Pin Uncombined Core (Refer to CK-12) | \$59.00 / cyl. |
| 65737P▲† | Small Format 7-Pin Uncombined Core (Refer to CK-12) | \$59.00 / cyl. |
| 68 | 8200 Line furnished with lever handle outside x knob inside (Excludes SLD Detention Knob) | Defaults to 8200 Lever Lock Price |
| 69 | 8200 Line furnished with lever handle inside x knob outside (Excludes SLD Detention Knob) | Defaults to 8200 Lever Lock Price |
| 70▲† | Small Format Interchangeable disposable plastic construction core | No addition |
| 72▲† | Small Format Interchangeable 6-pin construction core (7-pin with 11 option) | \$69.00 |
| 73▲† | Small Format 6-pin interchangeable core (refer to CK-8 for available keyways) | \$69.00 / cyl |
| 737P▲† | Small Format Interchangeable core (refer to CK 8 for available keyways) | \$69.00 / cyl |
| 74 | Lock case wrapped in lead - handing required (roses not available) | \$272.00 |
| 81▲† | Cylinder to accept Keso (83) and Keso F1 (F183) removable core - no core provided | No addition |
| F182† | SARGENT Keso Security Cylinder - patented - new key systems | \$84.00 / cyl. |
| F183▲† | SARGENT Keso Security Removable Core Cylinder - patented - new key systems | \$120.00 / cyl. |
| 82† | SARGENT Keso Security Cylinder (For existing systems only) | \$84.00 / cyl. |
| 83▲† | SARGENT Keso Security Removable Core Cylinder (For existing systems only) | \$120.00 / cyl. |
| 84▲† | SARGENT Keso Security Removable Construction Core Cylinder | See CK-18 |
| 85 | Tactile Warning - Abrasive coating on inside lever | \$45.00 |
| 86 | Tactile Warning - Abrasive coating on outside lever | \$45.00 |
| 87 | Tactile Warning - Abrasive coating on both levers | \$90.00 |
| AV | Anti Vandal Pull Trim (available in 32D finish), (Not available with 8270, 8271, 8272, 8273 functions) | \$212.00 |
| BR | SARGENT Bump Resistant Cylinders (N/A w/10, 22, 30, 60, 63, 64, 70, 72, 73, 737P, KESO, SC, & SE options) | \$23.00 /cyl. |
| DG1 | Patented Degree DG1 Key System | No Addition |
| DG160 | Hardware prepared for DG1-6300 Lg. Format IC cores, supplied with temporary plastic construction cores | No addition |
| DG163 | Patented Degree DG1 Large Format Interchangeable Core Cylinder - Includes master keying charges | \$77.00 |
| DG164 | Hardware prepared for DG1-6300 Lg. Format IC cores, supplied with temporary keyed construction cores | \$77.00 |
| DG2 | Patented Degree DG2 Key System incorporating a locking sidebar | \$58.00/cyl. |
| DG260 | Hardware prepared for DG2-6300 Lg. Format IC cores, supplied with temporary plastic construction cores | No addition |
| DG263 | Patented Degree DG2 Large Format Interchangeable Core Cylinder - Includes master keying charges | \$135.00 |
| DG264 | Hardware prepared for DG2-6300 Lg. Format IC cores, supplied with temporary keyed construction cores | \$77.00 |
| DG3 | Patented Degree DG3 Key System incorporating a locking sidebar and UL437 listed | \$82.00/cyl. |
| DG360 | Hardware prepared for DG3-6300 Lg. Format IC cores, supplied with temporary plastic construction cores | No addition |
| DG363 | Patented Degree DG3 Large Format Interchangeable Core Cylinder - Includes master keying charges | \$159.00 |
| DG364 | Hardware prepared for DG3-6300 Lg. Format IC cores, supplied with temporary keyed construction cores | \$77.00 |
| IDP | Integrated door position switch | \$100.00 |
| LC | Less Cylinder | -\$89.00/cyl. |
| LB | Extra large thumbturn | \$16.00 |
| OBS | Open Back Strike | \$73.00 |
| PHR | Deadbolt Privacy Function (available w/deadbolt function only) | \$100.00 |
| R01 | Mercury and Lenel compatible 1KΩ/2KΩ resistance supervision | \$100.00 |
| R03 | Software House compatible 1KΩ/2KΩ resistance supervision | \$100.00 |
| R04 | AMAG compatible 4-state supervision | \$100.00 |
| SC▲† | Schlage "C" Keyway cylinder, (Number 41 Cylinder Only, 0 bitted) | No addition |
| SE▲† | Schlage "E" Keyway cylinder, (Number 41 Cylinder Only, 0 bitted) | No addition |
| SG | MicroShield® - an antimicrobial powder coat finish | \$67.00 |
| T1 | Decorative thumbturn; backplate matches rose design chosen | No Addition |
| T2 | Decorative square thumbturn; backplate matches rose design chosen | No Addition |
| T3 | Decorative cylinder thumbturn; backplate matches rose design chosen | No Addition |
| WBS | Wrought Box Strike | No addition |

NOTES: ▲ Options not avail. with a standard 50 function lockout cylinder. † Not avail. with 60, 63, 64 options

| | | |
|-----|---|---------|
| CPC | Clear Powder Coat over 26D/32D - 8205 x CRH001 x RH x 32D x CPC All orders will continue to be handled as a "special" when CPC is ordered. | \$62.00 |
|-----|---|---------|

ASSA ABLOY, the global leader
in door opening solutions

Copyright © 2002-2019 Sargent Manufacturing Company, an ASSA ABLOY Group company. All rights reserved.
Reproduction in whole or in part without the express written permission of Sargent Manufacturing Company is prohibited.
Contact us at: 800-727-5477 or visit www.sargentlock.com. In Canada contact us at: 800-461-3007 or visit www.assaabloydss.ca

ASSA ABLOY

8200 STUDIO COLLECTION WOOSTER SQUARE

Rose Design:

CO (2-3/4")
CR (2-3/16")
LN (2")
O (2-3/4")
TO (2-3/4")
TR (2-3/16")
E2 (2-11/16")
E3 (2-1/16")
E4 (3-1/4")

Lever Design:

H001, H002



H001



H002

How to order:

21-8205 x E4H001 x RH x 10BE
Option 21
Function 8205
Rose E4
Lever H001
Hand RH
Finish 10BE

USA & Canada
Prices Effective
June 3, 2019

| NAC 8200 Electrified Mortise Locks with High Security Monitoring | | | | 10BE/26D/ BSP/WSP | 03/04/09/10/ 10B/10BL/14/15/ 20D/26 |
|--|----------------|------------------------|--------------------------------------|----------------------|---|
| Option | Function | Trim - Proximity Entry | Description | | |
| NAC | 82270-12V/-24V | Rose x Lever Design | Fail Safe w/Cylinder Override | \$1,460.00 | \$1,484.00 |
| NAC | 82271-12V/-24V | Rose x Lever Design | Fail Secure w/Cylinder Override | | |
| NAC | 82280-12V/-24V | Rose x Lever Design | Fail Safe w/Deadbolt w/Cyl.Override | \$1,535.00 | \$1,559.00 |
| NAC | 82281-12V/-24V | Rose x Lever Design | Fail Secure w/D.bolt w/Cyl.Override | | |
| NAC | 82274-12V/-24V | Rose x Lever Design | Fail Safe - No Cylinder | \$1,405.00 | \$1,429.00 |
| NAC | 82275-12V/-24V | Rose x Lever Design | Fail Secure - No Cylinder | | |
| NAC | 82284-12V/-24V | Rose x Lever Design | Fail Safe w/Deadbolt - No Cylinder | \$1,480.00 | \$1,504.00 |
| NAC | 82285-12V/-24V | Rose x Lever Design | Fail Secure w/Deadbolt - No Cylinder | | |

Note: Consult catalog for ordering information.

Specify hand and voltage (12v or 24v) when ordering

ML-42 MORTISE LOCKS

SARGENT®

ASSA ABLOY

OPTION

USA & Canada Prices Effective June 3, 2019

| Options | Description | Price |
|----------|---|---|
| 1▲ | 8200 Line with 1-1/16" wide front for 1-3/8" doors. | \$58.00 |
| 3 | Stainless steel hub (not available with 8289, 8291 & 8292 functions) | \$63.00 |
| 10▲ | SARGENT Signature Key System | \$58.00 / cyl. |
| 11†▲ | SARGENT XC Key System (not available with 10, 22, SC, SE options) | No addition |
| 1160 | SARGENT XC Large Format Interchangeable Plastic Disposable Construction Core | No addition |
| 1163 | SARGENT XC Large Format Interchangeable Core Cylinder - Includes masterkeying charges | \$77.00 |
| 1164 | SARGENT XC Large Format Interchangeable Construction Core Cylinder | \$77.00 |
| 1170 | Small Format interchangeable disposable construction core - to accept 7 Pin XC permanent core | No addition |
| 11727P | Small Format interchangeable keyed construction core - to accept 7 Pin XC permanent core | \$69.00 |
| 11737P | Small Format interchangeable core - to accept 7 pin XC permanent core | \$69.00 / cyl. |
| 21▲† | SARGENT Construction Key System (lost ball) Standard on all new systems established since 5/1/96 | \$16.00 / cyl. |
| 22▲† | SARGENT Construction Key System (split key) To be used on pre-established split key systems only | \$32.00 / cyl. |
| 23 | Locksets with flat 4 7/8" ANSI strike | No addition |
| 31 | Thick Doors - Extended Lip Required - Specify Length C to E - Cylinders - IMPORTANT- See catalog 7800/8200 option page for cylinder limitations - Below charges DO NOT include additional charges for special cylinder requirements | No addition |
| | Doors up to 2-1/2" thick - lock centered | No addition |
| | Doors 2-5/8" to 6" thick OR doors 1-3/4" thick w/max 1" paneling one side. For example: Specify 1-3/4" door with panel (Side) on inside or outside | Non Keyed function \$50.00 Keyed function \$100.00 |
| 49 | Visual Status Indicator - Available with 30, 36, 37 function - Rose Trims CR, E, L, LN, O, TR - Available with 26, 29, 38, 39 40, 41 functions - Rose Trim 8200 LN | \$92.00 |
| 49 | Occupancy Indicator with emergency Release - Available with 65, 66, 68 functions; Rose Trims 7800 CR, E, L, LN, O, TR | \$92.00 |
| 50 | Secured Indicator Rose- doors 1-5/8" to 2-1/4" thick- Avail.w/24,25,26,28,29,30,36,37,38,39,40,41,43,45,50,51,52,57,58,67 functions | \$62.00 |
| 60 | SARGENT Large Format Interchangeable Plastic Disposable Construction Core | No addition |
| 63 | SARGENT Large Format Interchangeable core cylinder, includes master keying charges | \$77.00 / cyl. |
| 64 | SARGENT Large Format Interchangeable Construction Core Cylinder | \$77.00 |
| 6573▲† | Small Format 6-Pin Uncombined Core (Refer to CK-12) | \$59.00 / cyl. |
| 65737P▲† | Small Format 7-Pin Uncombined Core (Refer to CK-12) | \$59.00 / cyl. |
| 68 | 8200 Line furnished with lever handle outside x knob inside (Excludes SLD Detention Knob) | Defaults to 8200 Lever Lock Price |
| 69 | 8200 Line furnished with lever handle inside x knob outside (Excludes SLD Detention Knob) | Defaults to 8200 Lever Lock Price |
| 70▲† | Small Format Interchangeable disposable plastic construction core | No addition |
| 72▲† | Small Format Interchangeable 6-pin construction core (7-pin with 11 option) | See CK-2 |
| 73▲† | Small Format 6-pin interchangeable core (refer to CK-8 for available keyways) | \$69.00 / cyl |
| 737P▲† | Small Format Interchangeable core (refer to CK 8 for available keyways) | \$69.00 / cyl |
| 74 | Lock case wrapped in lead - handing required (roses not available) | \$272.00 |
| 81▲† | Cylinder to accept Keso (83) and Keso F1 (F183) removable core - no core provided | No addition |
| F182† | SARGENT Keso Security Cylinder - patented - new key systems | \$84.00 / cyl. |
| F183▲† | SARGENT Keso Security Removable Core Cylinder - patented - new key systems | \$120.00 / cyl. |
| 82† | SARGENT Keso Security Cylinder (For existing systems only) | \$84.00 / cyl. |
| 83▲† | SARGENT Keso Security Removable Core Cylinder (For existing systems only) | \$120.00 / cyl. |
| 84▲† | SARGENT Keso Security Removable Construction Core Cylinder | See CK-18 |
| 85 | Tactile Warning - Abrasive coating on inside lever | \$45.00 |
| 86 | Tactile Warning - Abrasive coating on outside lever | \$45.00 |
| 87 | Tactile Warning - Abrasive coating on both levers | \$90.00 |
| AV | Anti Vandal Pull Trim (available in 32D finish), (Not available with 8270, 8271, 8272, 8273 functions) | \$212.00 |
| BR | SARGENT Bump Resistant Cylinders (N/A w/10, 22, 30, 60, 63, 64, 70, 72, 73, 737P, KESO, SC, & SE options) | \$23.00 /cyl. |
| DG1 | Patented Degree DG1 Key System | No Addition |
| DG160 | Hardware prepared for DG1-6300 Lg. Format IC cores, supplied with temporary plastic construction cores | No addition |
| DG163 | Patented Degree DG1 Large Format Interchangeable Core Cylinder - Includes master keying charges | \$77.00 |
| DG164 | Hardware prepared for DG1-6300 Lg. Format IC cores, supplied with temporary keyed construction cores | \$77.00 |
| DG2 | Patented Degree DG2 Key System incorporating a locking sidebar | \$58.00/cyl. |
| DG260 | Hardware prepared for DG2-6300 Lg. Format IC cores, supplied with temporary plastic construction cores | No addition |
| DG263 | Patented Degree DG2 Large Format Interchangeable Core Cylinder - Includes master keying charges | \$135.00 |
| DG264 | Hardware prepared for DG2-6300 Lg. Format IC cores, supplied with temporary keyed construction cores | \$77.00 |
| DG3 | Patented Degree DG3 Key System incorporating a locking sidebar and UL437 listed | \$82.00/cyl. |
| DG360 | Hardware prepared for DG3-6300 Lg. Format IC cores, supplied with temporary plastic construction cores | No addition |
| DG363 | Patented Degree DG3 Large Format Interchangeable Core Cylinder - Includes master keying charges | \$159.00 |
| DG364 | Hardware prepared for DG3-6300 Lg. Format IC cores, supplied with temporary keyed construction cores | \$77.00 |
| DX | Deadbolt Monitoring (not available with 50, 74) | \$182.00 |
| LC | Less Cylinder | -\$89.00/cyl. |
| LB | Extra large thumbturn | \$16.00 |
| LX | Latchbolt Monitor - available with all non-deadbolt functions; not available with DX option | \$185.00 |
| OBS | Open Back Strike | \$73.00 |
| RX | Request to Exit | \$190.00 |
| SC▲† | Schlage "C" Keyway cylinder, (Number 41 Cylinder Only, 0 bitted) | No addition |
| SE▲† | Schlage "E" Keyway cylinder, (Number 41 Cylinder Only, 0 bitted) | No addition |
| SG | MicroShield® - an antimicrobial powder coat finish | \$67.00 |
| T1 | Decorative thumbturn; backplate matches rose design chosen | No Addition |
| T2 | Decorative square thumbturn; backplate matches rose design chosen | No Addition |
| T3 | Decorative cylinder thumbturn; backplate matches rose design chosen | No Addition |
| WBS | Wrought Box Strike | No addition |

NOTES: ▲ Options not avail. with a standard 50 function lockout cylinder. † Not avail. with 60, 63, 64 options

CPC Clear Powder Coat over 26D/32D - 8205 x CRH004 x RH x 32D x CPC \$62.00
All orders will continue to be handled as a "special" when CPC is ordered.

ASSA ABLOY

8200 STUDIO COLLECTION WOOSTER SQUARE & GRANT PARK

Rose Design:

CO (2-3/4")
CR (2-3/16")
LN (2")
O (2-3/4")
TO (2-3/4")
TR (2-3/16")
E2 (2-11/16")
E3 (2-1/16")
E4 (3-1/4")

Lever Design:

H003, H004, H005, H006, H007,
H008, H009, H010, H011



H004



H005

How to order:

21-8205 x E4H003 x RH x 10BE
Option 21
Function 8205
Rose E4
Lever H003
Hand RH
Finish 10BE

USA & Canada Prices Effective June 3, 2019

| Function | | Finish | |
|---|------------------------------------|------------------|--|
| | | 10BE/26D/BSP/WSP | 03/04/09/10/10B/10BL/14/15/20D/26/32/32D |
| Single Cyl | | | |
| 8204 | Storeroom or Closet | | |
| 8205 | Office or Entry | \$1,169.00 | \$1,193.00 |
| 8237 | Classroom | | |
| 8255 | Office or Entry | | |
| <hr/> | | | |
| 8206 | Storeroom or Service | | |
| 8231 | Utility | | |
| 8236 | Closet | | |
| 8256 | Office or Inner Entry | \$1,192.00 | \$1,216.00 |
| 8257, 8258, 8267 | Institutional Privacy | | |
| 8289 | Holdback | | |
| 8291 | All Purpose Holdback | | |
| Single Cyl With Deadbolt | | | |
| 8224 | Room Door | | |
| 8225 | Dormitory or Exit | | |
| 8227 | Closet or Storeroom | | |
| 8228, 8230 | Dummy Trim Deadlock | | |
| 8235 | Storeroom | \$1,220.00 | \$1,244.00 |
| 8243 | Apartment Corridor | | |
| 8245 | Dormitory or Exit | | |
| 8247 | Front Door or Apartment Corridor | | |
| 8251 | Storeroom Deadbolt | | |
| 8250 | Hotel Guest Lock | \$1,255.00 | \$1,279.00 |
| Double Cyl No Deadbolt | | | |
| 8216 | Apartment or Exit or Public Toilet | | |
| 8217 | Asylum or Institutional | | |
| 8238 | Classroom Security Intruder | | |
| 8259 | School Security | \$1,265.00 | \$1,289.00 |
| 8290 | Classroom Security Holdback | | |
| 8292 | All Purpose Holdback | | |
| Double Cyl With Deadbolt | | | |
| 8226 | Store Door | | |
| 8229 | Dummy Trim Deadlock | | |
| 8239, 8240 | Classroom Security Intruder | | |
| 8241 | Classroom Security | | |
| 8246 | Dormitory or Exit | \$1,285.00 | \$1,309.00 |
| 8248 | Store Door | | |
| 8249 | Security Deadbolt | | |
| 8252 | Institutional | | |
| Electro Mechanical Single Cyl – Specify 12V or 24V | | | |
| 8270-12V / 8270-24V | Fail Safe | \$1,365.00 | \$1,389.00 |
| 8271-12V / 8271-24V | Fail Secure | | |
| Electro Mechanical Double Cyl – Specify 12V or 24V | | | |
| 8272-12V / 8272-24V | Fail Safe | \$1,422.00 | \$1,446.00 |
| 8273-12V / 8273-24V | Fail Secure | | |
| Non Keyed | | | |
| 8213 | Communication or Exit | \$1,016.00 | \$1,040.00 |
| 8215 | Passage or Closet | | |
| 8265 | Privacy Bedroom or Bath (Latch) | \$1,114.00 | \$1,138.00 |
| 8266, 8268 | Privacy Bedroom or Bath (Deadbolt) | \$1,152.00 | \$1,176.00 |
| 8293* | Single Dummy Trim | \$453.00 | \$477.00 |
| 8294 | Double Dummy Trim | \$849.00 | \$873.00 |
| 8295 | Single Dummy Trim w/Lockbody | \$543.00 | \$567.00 |
| 8296 | Double Dummy Trim w/Lockbody | \$937.00 | \$961.00 |
| 8297 | Double Dummy w/Active Trim | \$1,016.00 | \$1,040.00 |

ML-44 MORTISE LOCKS

SARGENT®

ASSA ABLOY

OPTION

USA & Canada Prices Effective June 3, 2019

| Options | Description | Price |
|----------|--|---|
| 1▲ | 8200 Line with 1-1/16" wide front for 1-3/8" doors. | \$58.00 |
| 3 | Stainless steel hub (not available with 8289, 8291 & 8292 functions) | \$63.00 |
| 10▲ | SARGENT Signature Key System | \$58.00 / cyl. |
| 11†▲ | SARGENT XC Key System (not available with 10, 22, SC, SE options) | No addition |
| 1160 | SARGENT XC Large Format Interchangeable Plastic Disposable Construction Core | No addition |
| 1163 | SARGENT XC Large Format Interchangeable Core Cylinder - Includes masterkeying charges | \$77.00 |
| 1164 | SARGENT XC Large Format Interchangeable Construction Core Cylinder | \$77.00 |
| 1170 | Small Format interchangeable disposable construction core - to accept 7 Pin XC permanent core | No addition |
| 11727P | Small Format interchangeable keyed construction core - to accept 7 Pin XC permanent core | \$69.00 |
| 11737P | Small Format interchangeable core - to accept 7 pin XC permanent core | \$69.00 /cyl. |
| 21▲† | SARGENT Construction Key System (lost ball) Standard on all new systems established since 5/1/96 | \$16.00 / cyl. |
| 22▲† | SARGENT Construction Key System (split key) To be used on pre-established split key systems only | \$32.00 / cyl. |
| 23 | Locksets with flat 4 7/8" ANSI strike | No addition |
| 31 | Thick Doors - Extended Lip Required - Specify Length C to E - Cylinders - IMPORTANT- See catalog 7800/8200 option page for cylinder limitations - Below charges DO NOT include additional charges for special cylinder requirements Doors up to 2-1/2" thick - lock centered Doors 2-5/8" to 6" thick OR doors 1-3/4" thick w/max 1" paneling one side. For example: Specify 1-3/4" door with panel (Side) on inside or outside | No addition Non Keyed function \$50.00 Keyed function \$100.00 |
| 49 | Visual Status Indicator - Available with 30, 36, 37 function - Rose Trims CR, E, L, LN, O, TR - Available with 26, 29, 38, 39 40, 41 functions - Rose Trim 8200 LN | \$92.00 |
| 49 | Occupancy Indicator with emergency Release - Available with 65, 66, 68 functions; Rose Trims 7800 CR, E, L, LN, O, TR | \$92.00 |
| 50 | Secured Indicator Rose- doors 1-5/8" to 2-1/4" thick- Avail.w/24,25,26,28,29,30,36,37,38,39,40,41,43,45,50,51,52,57,58,67 functions | \$62.00 |
| 60 | SARGENT Large Format Interchangeable Plastic Disposable Construction Core | No addition |
| 63 | SARGENT Large Format Interchangeable core cylinder, includes master keying charges | \$77.00 / cyl. |
| 64 | SARGENT Large Format Interchangeable Construction Core Cylinder | \$77.00 |
| 6573▲† | Small Format 6-Pin Uncombined Core (Refer to CK-12) | \$59.00 / cyl. |
| 65737P▲† | Small Format 7-Pin Uncombined Core (Refer to CK-12) | \$59.00 / cyl. |
| 68 | 8200 Line furnished with lever handle outside x knob inside (Excludes SLD Detention Knob) | Defaults to 8200 Lever Lock Price |
| 69 | 8200 Line furnished with lever handle inside x knob outside (Excludes SLD Detention Knob) | Defaults to 8200 Lever Lock Price |
| 70▲† | Small Format Interchangeable disposable plastic construction core | No addition |
| 72▲† | Small Format Interchangeable 6-pin construction core (7-pin with 11 option) | \$69.00 |
| 73▲† | Small Format 6-pin interchangeable core (refer to CK-8 for available keyways) | \$69.00 / cyl |
| 737P▲† | Small Format Interchangeable core (refer to CK 8 for available keyways) | \$69.00 / cyl |
| 74 | Lock case wrapped in lead - handing required (roses not available) | \$272.00 |
| 81▲† | Cylinder to accept Keso (83) and Keso F1 (F183) removable core - no core provided | No addition |
| F182† | SARGENT Keso Security Cylinder - patented - new key systems | \$84.00 / cyl. |
| F183▲† | SARGENT Keso Security Removable Core Cylinder - patented - new key systems | \$120.00 / cyl. |
| 82† | SARGENT Keso Security Cylinder (For existing systems only) | \$84.00 / cyl. |
| 83▲† | SARGENT Keso Security Removable Core Cylinder (For existing systems only) | \$120.00 / cyl. |
| 84▲† | SARGENT Keso Security Removable Construction Core Cylinder | See CK-18 |
| 85 | Tactile Warning - Abrasive coating on inside lever | \$45.00 |
| 86 | Tactile Warning - Abrasive coating on outside lever | \$45.00 |
| 87 | Tactile Warning - Abrasive coating on both levers | \$90.00 |
| AV | Anti Vandal Pull Trim (available in 32D finish), (Not available with 8270, 8271, 8272, 8273 functions) | \$212.00 |
| BR | SARGENT Bump Resistant Cylinders (N/A w/10, 22, 30, 60, 63, 64, 70, 72, 73, 737P, KESO, SC, & SE options) | \$23.00 /cyl. |
| DG1 | Patented Degree DG1 Key System | No Addition |
| DG160 | Hardware prepared for DG1-6300 Lg. Format IC cores, supplied with temporary plastic construction cores | No addition |
| DG163 | Patented Degree DG1 Large Format Interchangeable Core Cylinder - Includes master keying charges | \$77.00 |
| DG164 | Hardware prepared for DG1-6300 Lg. Format IC cores, supplied with temporary keyed construction cores | \$77.00 |
| DG2 | Patented Degree DG2 Key System incorporating a locking sidebar | \$58.00/cyl. |
| DG260 | Hardware prepared for DG2-6300 Lg. Format IC cores, supplied with temporary plastic construction cores | No addition |
| DG263 | Patented Degree DG2 Large Format Interchangeable Core Cylinder - Includes master keying charges | \$135.00 |
| DG264 | Hardware prepared for DG2-6300 Lg. Format IC cores, supplied with temporary keyed construction cores | \$77.00 |
| DG3 | Patented Degree DG3 Key System incorporating a locking sidebar and UL437 listed | \$82.00/cyl. |
| DG360 | Hardware prepared for DG3-6300 Lg. Format IC cores, supplied with temporary plastic construction cores | No addition |
| DG363 | Patented Degree DG3 Large Format Interchangeable Core Cylinder - Includes master keying charges | \$159.00 |
| DG364 | Hardware prepared for DG3-6300 Lg. Format IC cores, supplied with temporary keyed construction cores | \$77.00 |
| IDP | Integrated door position switch | \$100.00 |
| LC | Less Cylinder | -\$89.00/cyl. |
| LB | Extra large thumbturn | \$16.00 |
| OBS | Open Back Strike | \$73.00 |
| PHR | Deadbolt Privacy Function (available w/deadbolt function only) | \$100.00 |
| R01 | Mercury and Lenel compatible 1KΩ/2KΩ resistance supervision | \$100.00 |
| R03 | Software House compatible 1KΩ/2KΩ resistance supervision | \$100.00 |
| R04 | AMAG compatible 4-state supervision | \$100.00 |
| SC▲† | Schlage "C" Keyway cylinder, (Number 41 Cylinder Only, 0 bitted) | No addition |
| SE▲† | Schlage "E" Keyway cylinder, (Number 41 Cylinder Only, 0 bitted) | No addition |
| SG | MicroShield® - an antimicrobial powder coat finish | \$67.00 |
| T1 | Decorative thumbturn; backplate matches rose design chosen | No Addition |
| T2 | Decorative square thumbturn; backplate matches rose design chosen | No Addition |
| T3 | Decorative cylinder thumbturn; backplate matches rose design chosen | No Addition |
| WBS | Wrought Box Strike | No addition |

NOTES: ▲ Options not avail. with a standard 50 function lockout cylinder. † Not avail. with 60, 63, 64 options

| | | |
|-----|---|---------|
| CPC | Clear Powder Coat over 26D/32D - 8205 x CRH001 x RH x 32D x CPC All orders will continue to be handled as a "special" when CPC is ordered. | \$62.00 |
|-----|---|---------|

Rose Design:

CO (2-3/4")
CR (2-3/16")
LN (2")
O (2-3/4")
TO (2-3/4")
TR (2-3/16")
E2 (2-11/16")
E3 (2-1/16")
E4 (3-1/4")

Lever Design:

H003, H004, H005, H006, H007,
H008, H009, H010, H011



H004

H005

How to order:

21-8205 x E4H003 x RH x 10BE
Option 21
Function 8205
Rose E4
Lever H003
Hand RH
Finish 10BE

USA & Canada Prices Effective June 3, 2019

| NAC 8200 Electrified Mortise Locks with High Security Monitoring | | | | 10BE/26D/ BSP/WSP | 03/04/09/10/ 10B/10BL/14/15/ 20D/26 |
|--|----------------|------------------------|--------------------------------------|----------------------|---|
| Option | Function | Trim - Proximity Entry | Description | | |
| NAC | 82270-12V/-24V | Rose x Lever Design | Fail Safe w/Cylinder Override | \$1,540.00 | \$1,564.00 |
| NAC | 82271-12V/-24V | Rose x Lever Design | Fail Secure w/Cylinder Override | | |
| NAC | 82280-12V/-24V | Rose x Lever Design | Fail Safe w/Deadbolt w/Cyl.Override | \$1,615.00 | \$1,639.00 |
| NAC | 82281-12V/-24V | Rose x Lever Design | Fail Secure w/D.bolt w/Cyl.Override | | |
| NAC | 82274-12V/-24V | Rose x Lever Design | Fail Safe - No Cylinder | \$1,485.00 | \$1,509.00 |
| NAC | 82275-12V/-24V | Rose x Lever Design | Fail Secure - No Cylinder | | |
| NAC | 82284-12V/-24V | Rose x Lever Design | Fail Safe w/Deadbolt - No Cylinder | \$1,560.00 | \$1,584.00 |
| NAC | 82285-12V/-24V | Rose x Lever Design | Fail Secure w/Deadbolt - No Cylinder | | |

Note: Consult catalog for ordering information.

Specify hand and voltage (12v or 24v) when ordering

ML-46 MORTISE LOCKS

SARGENT®

ASSA ABLOY

OPTIONS

USA & Canada Prices Effective June 3, 2019

| Options | Description | Price |
|----------|---|--|
| 1▲ | 8200 Line with 1-1/16" wide front for 1-3/8" doors. | \$58.00 |
| 3 | Stainless steel hub (not available with 8289, 8291 & 8292 functions) | \$63.00 |
| 10▲ | SARGENT Signature Key System | \$58.00 / cyl. |
| 11†▲ | SARGENT XC Key System (not available with 10, 22, SC, SE options) | No addition |
| 1160 | SARGENT XC Large Format Interchangeable Plastic Disposable Construction Core | No addition |
| 1163 | SARGENT XC Large Format Interchangeable Core Cylinder - Includes masterkeying charges | \$77.00 |
| 1164 | SARGENT XC Large Format Interchangeable Construction Core Cylinder | \$77.00 |
| 1170 | Small Format interchangeable disposable construction core - to accept 7 Pin XC permanent core | No addition |
| 11727P | Small Format interchangeable keyed construction core - to accept 7 Pin XC permanent core | \$69.00 |
| 11737P | Small Format interchangeable core - to accept 7 pin XC permanent core | \$69.00 / cyl. |
| 21▲† | SARGENT Construction Key System (lost ball) Standard on all new systems established since 5/1/96 | \$16.00 / cyl. |
| 22▲† | SARGENT Construction Key System (split key) To be used on pre-established split key systems only | \$32.00 / cyl. |
| 23 | Locksets with flat 4 7/8" ANSI strike | No addition |
| 31 | Thick Doors - Extended Lip Required - Specify Length C to E - Cylinders - IMPORTANT- See catalog 7800/8200 option page for cylinder limitations - Below charges DO NOT include additional charges for special cylinder requirements | |
| | Doors up to 2-1/2" thick - lock centered | No addition |
| | Doors 2-5/8" to 6" thick OR doors 1-3/4" thick w/max 1" paneling one side. For example: Specify 1-3/4" door with panel (Side) on inside or outside | Non Keyed function \$50.00 Keyed function \$100.00 |
| 49 | Visual Status Indicator - Available with 30, 36, 37 function - Rose Trims CR, E, L, LN, O, TR - Available with 26, 29, 38, 39 40, 41 functions - Rose Trim 8200 LN | \$92.00 |
| 49 | Occupancy Indicator with emergency Release - Available with 65, 66, 68 functions; Rose Trims 7800 CR, E, L, LN, O, TR | \$92.00 |
| 50 | Secured Indicator Rose- doors 1-5/8" to 2-1/4" thick- Avail.w/24,25,26,28,29,30,36,37,38,39,40,41,43,45,50,51,52,57,58,67 functions | \$62.00 |
| 60 | SARGENT Large Format Interchangeable Plastic Disposable Construction Core | No addition |
| 63 | SARGENT Large Format Interchangeable core cylinder, includes master keying charges | \$77.00 / cyl. |
| 64 | SARGENT Large Format Interchangeable Construction Core Cylinder | \$77.00 |
| 6573▲† | Small Format 6-Pin Uncombined Core (Refer to CK-12) | \$59.00 / cyl. |
| 65737P▲† | Small Format 7-Pin Uncombined Core (Refer to CK-12) | \$59.00 / cyl. |
| 68 | 8200 Line furnished with lever handle outside x knob inside (Excludes SLD Detention Knob) | Defaults to 8200 Lever Lock Price |
| 69 | 8200 Line furnished with lever handle inside x knob outside (Excludes SLD Detention Knob) | Defaults to 8200 Lever Lock Price |
| 70▲† | Small Format Interchangeable disposable plastic construction core | No addition |
| 72▲† | Small Format Interchangeable 6-pin construction core (7-pin with 11 option) | See CK-2 |
| 73▲† | Small Format 6-pin interchangeable core (refer to CK-8 for available keyways) | \$69.00 / cyl |
| 737P▲† | Small Format Interchangeable core (refer to CK 8 for available keyways) | \$69.00 / cyl |
| 74 | Lock case wrapped in lead - handing required (roses not available) | \$272.00 |
| 81▲† | Cylinder to accept Keso (83) and Keso F1 (F183) removable core - no core provided | No addition |
| F182† | SARGENT Keso Security Cylinder - patented - new key systems | \$84.00 / cyl. |
| F183▲† | SARGENT Keso Security Removable Core Cylinder - patented - new key systems | \$120.00 / cyl. |
| 82† | SARGENT Keso Security Cylinder (For existing systems only) | \$84.00 / cyl. |
| 83▲† | SARGENT Keso Security Removable Core Cylinder (For existing systems only) | \$120.00 / cyl. |
| 84▲† | SARGENT Keso Security Removable Construction Core Cylinder | See CK-18 |
| 85 | Tactile Warning - Abrasive coating on inside lever | \$45.00 |
| 86 | Tactile Warning - Abrasive coating on outside lever | \$45.00 |
| 87 | Tactile Warning - Abrasive coating on both levers | \$90.00 |
| AV | Anti Vandal Pull Trim (available in 32D finish), (Not available with 8270, 8271, 8272, 8273 functions) | \$212.00 |
| BR | SARGENT Bump Resistant Cylinders (N/A w/10, 22, 30, 60, 63, 64, 70, 72, 73, 737P, KESO, SC, & SE options) | \$23.00 /cyl. |
| DG1 | Patented Degree DG1 Key System | No Addition |
| DG160 | Hardware prepared for DG1-6300 Lg. Format IC cores, supplied with temporary plastic construction cores | No addition |
| DG163 | Patented Degree DG1 Large Format Interchangeable Core Cylinder - Includes master keying charges | \$77.00 |
| DG164 | Hardware prepared for DG1-6300 Lg. Format IC cores, supplied with temporary keyed construction cores | \$77.00 |
| DG2 | Patented Degree DG2 Key System incorporating a locking sidebar | \$58.00/cyl. |
| DG260 | Hardware prepared for DG2-6300 Lg. Format IC cores, supplied with temporary plastic construction cores | No addition |
| DG263 | Patented Degree DG2 Large Format Interchangeable Core Cylinder - Includes master keying charges | \$135.00 |
| DG264 | Hardware prepared for DG2-6300 Lg. Format IC cores, supplied with temporary keyed construction cores | \$77.00 |
| DG3 | Patented Degree DG3 Key System incorporating a locking sidebar and UL437 listed | \$82.00/cyl. |
| DG360 | Hardware prepared for DG3-6300 Lg. Format IC cores, supplied with temporary plastic construction cores | No addition |
| DG363 | Patented Degree DG3 Large Format Interchangeable Core Cylinder - Includes master keying charges | \$159.00 |
| DG364 | Hardware prepared for DG3-6300 Lg. Format IC cores, supplied with temporary keyed construction cores | \$77.00 |
| DX | Deadbolt Monitoring (not available with 50, 74) | \$182.00 |
| LC | Less Cylinder | -\$89.00/cyl. |
| LB | Extra large thumbturn | \$16.00 |
| LX | Latchbolt Monitor - available with all non-deadbolt functions; not available with DX option | \$185.00 |
| OBS | Open Back Strike | \$73.00 |
| RX | Request to Exit | \$190.00 |
| SC▲† | Schlage "C" Keyway cylinder, (Number 41 Cylinder Only, 0 bitted) | No addition |
| SE▲† | Schlage "E" Keyway cylinder, (Number 41 Cylinder Only, 0 bitted) | No addition |
| SG | MicroShield® - an antimicrobial powder coat finish | \$67.00 |
| T1 | Decorative thumbturn; backplate matches rose design chosen | No Addition |
| T2 | Decorative square thumbturn; backplate matches rose design chosen | No Addition |
| T3 | Decorative cylinder thumbturn; backplate matches rose design chosen | No Addition |
| WBS | Wrought Box Strike | No addition |

NOTES: ▲ Options not avail. with a standard 50 function lockout cylinder. † Not avail. with 60, 63, 64 options

| | | |
|-----|---|---------|
| CPC | Clear Powder Coat over 26D/32D - 8205 x CRMD x RH x 32D x CPC All orders will continue to be handled as a "special" when CPC is ordered. | \$62.00 |
|-----|---|---------|

ASSA ABLOY

8200 STUDIO COLLECTION

USA & Canada Prices Effective June 3, 2019

Rose Design:

CO (2-3/4")
CR (2-3/16")
LN (2")
O (2-3/4")
TO (2-3/4")
TR (2-3/16")
E2 (2-11/16")
E3 (2-1/16")
E4 (3-1/4")

Studio Lever Series Designs:

Studio Collection Levers Except for Gramercy, Wooster Square, & Grant Park
* Following levers not available in 32 & 32D: MA, MC, MH, MK, MM, MN, MO, MP, MQ, MS, MT, MU, MV, MX, MY, MZ, NS, NU

How to order:

21-8205 x CRMD x RH x 26D
Option 21
Function 8205
Rose CR
Lever MD
Hand RH
Finish 26D

| Function | | Finish | |
|---|------------------------------------|------------------|--|
| | | 10BE/26D/BSP/WSP | 03/04/09/10/10B/10BL/14/15/20D/26/*32/*32D |
| Single Cyl | | | |
| 8204 | Storeroom or Closet | | |
| 8205 | Office or Entry | \$1,006.00 | \$1,030.00 |
| 8237 | Classroom | | |
| 8255 | Office or Entry | | |
| <hr/> | | | |
| 8206 | Storeroom or Service | | |
| 8231 | Utility | | |
| 8236 | Closet | | |
| 8256 | Office or Inner Entry | \$1,031.00 | \$1,055.00 |
| 8257, 8258, 8267 | Institutional Privacy | | |
| 8289 | Holdback | | |
| 8291 | All Purpose Holdback | | |
| <hr/> | | | |
| Single Cyl With Deadbolt | | | |
| 8224 | Room Door | | |
| 8225 | Dormitory or Exit | | |
| 8227 | Closet or Storeroom | | |
| 8228, 8230 | Dummy Trim Deadlock | \$1,060.00 | \$1,084.00 |
| 8235 | Storeroom | | |
| 8243 | Apartment Corridor | | |
| 8245 | Dormitory or Exit | | |
| 8247 | Front Door or Apartment Corridor | | |
| 8251 | Storeroom Deadbolt | | |
| 8250 | Hotel Guest Lock | \$1,092.00 | \$1,116.00 |
| <hr/> | | | |
| Double Cyl No Deadbolt | | | |
| 8216 | Apartment or Exit or Public Toilet | | |
| 8217 | Asylum or Institutional | | |
| 8238 | Classroom Security Intruder | | |
| 8259 | School Security | \$1,108.00 | \$1,132.00 |
| 8290 | Classroom Security Holdback | | |
| 8292 | All Purpose Holdback | | |
| <hr/> | | | |
| Double Cyl With Deadbolt | | | |
| 8226 | Store Door | | |
| 8229 | Dummy Trim Deadlock | | |
| 8239, 8240 | Classroom Security Intruder | | |
| 8241 | Classroom Security | \$1,129.00 | \$1,153.00 |
| 8246 | Dormitory or Exit | | |
| 8248 | Store Door | | |
| 8249 | Security Deadbolt | | |
| 8252 | Institutional | | |
| <hr/> | | | |
| Electro Mechanical Single Cyl – Specify 12V or 24V | | | |
| 8270-12V / 8270-24V | Fail Safe | \$1,202.00 | \$1,226.00 |
| 8271-12V / 8271-24V | Fail Secure | | |
| <hr/> | | | |
| Electro Mechanical Double Cyl – Specify 12V or 24V | | | |
| 8272-12V / 8272-24V | Fail Safe | \$1,259.00 | \$1,283.00 |
| 8273-12V / 8273-24V | Fail Secure | | |
| <hr/> | | | |
| Non Keyed | | | |
| 8213 | Communication or Exit | \$806.00 | \$830.00 |
| 8215 | Passage or Closet | | |
| 8265 | Privacy Bedroom or Bath (Latch) | \$887.00 | \$911.00 |
| 8266, 8268 | Privacy Bedroom or Bath (Deadbolt) | \$983.00 | \$1,007.00 |
| 8293* | Single Dummy Trim | \$333.00 | \$345.00 |
| 8294 | Double Dummy Trim | \$665.00 | \$689.00 |
| 8295 | Single Dummy Trim w/Lockbody | \$427.00 | \$439.00 |
| 8296 | Double Dummy Trim w/Lockbody | \$763.00 | \$787.00 |
| 8297 | Double Dummy w/Active Trim | \$846.00 | \$870.00 |

ML-48 MORTISE LOCKS

SARGENT®

ASSA ABLOY

OPTION

USA & Canada Prices Effective June 3, 2019

| Options | Description | Price |
|----------|--|--|
| 1▲ | 8200 Line with 1-1/16" wide front for 1-3/8" doors. | \$58.00 |
| 3 | Stainless steel hub (not available with 8289, 8291 & 8292 functions) | \$63.00 |
| 10▲ | SARGENT Signature Key System | \$58.00 / cyl. |
| 11†▲ | SARGENT XC Key System (not available w/10, KESO, SC, SE) | No addition |
| 1160 | SARGENT XC Large Format Interchangeable Plastic Disposable Construction Core | No addition |
| 1163 | SARGENT XC Large Format Interchangeable Core Cylinder - Includes masterkeying charges | \$77.00 |
| 1164 | SARGENT XC Large Format Interchangeable Construction Core Cylinder | \$77.00 |
| 1170 | Small Format interchangeable disposable construction core - to accept 7 Pin XC permanent core | No addition |
| 11727P | Small Format interchangeable keyed construction core - to accept 7 Pin XC permanent core | \$69.00 |
| 11737P | Small Format interchangeable core - to accept 7 pin XC permanent core | \$69.00 / cyl. |
| 21▲† | SARGENT Construction Key System (lost ball) Standard on all new systems established since 5/1/96 | \$16.00 / cyl. |
| 22▲† | SARGENT Construction Key System (split key) To be used on pre-established split key systems only | \$32.00 / cyl. |
| 23 | Locksets with flat 4 7/8" ANSI strike | No addition |
| 31 | Thick Doors - Extended Lip Required - Specify Length C to E IMPORTANT: See 7800/8200 Catalog Option Page for Cylinder Limits – DOES NOT include additional Charges for Special Cylinder Requirements | No addition |
| | Doors up to 2-1/2" thick - lock centered • Doors 2-5/8" to 6" thick OR doors 1-3/4" thick w/max 1" paneling one side. For example: Specify 1-3/4" door with panel (Side) on inside or outside | Non Keyed function \$50.00 Keyed function \$100.00 |
| 36 | 6 Lobe security head screws | \$23.00 |
| 37 | Spanner head screws | \$16.00 |
| 49 | Visual Status Indicator – Available with 30, 36, 37 function – Rose Trims CR, E, L, LN, O, TR – Available with 26, 29, 38, 39 40, 41 functions – Rose Trim 8200 LN | \$92.00 |
| 49 | Occupancy Indicator with emergency Release – Available with 65, 66, 68 functions; Rose Trims 7800 CR, E, L, LN, O, TR | \$92.00 |
| 50 | Secured Indicator Rose– doors 1-5/8" to 2-1/4" thick– Avail.w/24,25,26,28,29,30,36,37,38,39,40,41,43,45,50,51,52,57,58,67 functions | \$62.00 |
| 60 | SARGENT Large Format Interchangeable Plastic Disposable Construction Core | No addition |
| 63 | SARGENT Large Format Interchangeable core cylinder, includes master keying charges | \$77.00 / cyl |
| 64 | SARGENT Large Format Interchangeable Construction Core Cylinder | \$77.00 |
| 6573▲† | Small Format 6-Pin Uncombined Core (Refer to CK-12) | \$59.00 / cyl. |
| 65737P▲† | Small Format 7-Pin Uncombined Core (Refer to CK-12) | \$59.00 / cyl. |
| 68 | 8200 Line furnished with lever handle outside x knob inside (Excludes SLD Detention Knob) | Defaults to 8200 Lever Lock Price |
| 69 | 8200 Line furnished with lever handle inside x knob outside (Excludes SLD Detention Knob) | Defaults to 8200 Lever Lock Price |
| 70▲† | Small Format interchangeable disposable plastic construction core | No addition |
| 72▲† | Small Format interchangeable 6-Pin construction core | \$69.00 |
| 73▲† | Small Format interchangeable core 6-pin Includes MK and GMK keying charges | \$69.00 / cyl |
| 737P▲† | Small Format interchangeable core 7-pin (refer to CK-12 for available keyways) Includes MK and GMK keying charges | \$69.00 / cyl |
| 74 | Lock case wrapped in lead – handing required (roses not available) | \$262.00 |
| 81▲† | Cylinder to accept Keso (83) and Keso F1 (F183) removable core – no core provided | No addition |
| F182† | SARGENT Keso Security Cylinder – patented – new key systems | \$84.00 / cyl. |
| F183▲† | SARGENT Keso Security Removable Core Cylinder – patented – new key systems | \$120.00 / cyl. |
| 82† | SARGENT Keso Security Cylinder (For existing systems only) | \$84.00 / cyl. |
| 83▲† | SARGENT Keso Security Removable Core Cylinder (For existing systems only) | \$120.00 / cyl. |
| 84▲† | SARGENT Keso Security Removable Construction Core Cylinder | See CK-18 |
| 85 | Tactile Warning - Abrasive Coating on Inside Lever | \$45.00 |
| 86 | Tactile Warning - Abrasive Coating on Outside Lever | \$45.00 |
| 87 | Tactile Warning - Abrasive Coating on Outside & Inside Lever | \$90.00 |
| AV | Anti Vandal Pull Trim (available in 32D finish), (Not available with 8270, 8271, 8272, 8273 functions) | \$212.00 |
| BR | SARGENT Bump Resistant Cylinders (N/A w/10, 22, 30, 60, 63, 64, 70, 72, 73, 737P, KESO, SC, & SE options) | \$23.00 /cyl. |
| DG1 | Patented Degree DG1 Key System | No Addition |
| DG160 | Hardware prepared for DG1-6300 Lg. Format IC cores, supplied with temporary plastic construction cores | No addition |
| DG163 | Patented Degree DG1 Large Format Interchangeable Core Cylinder - Includes master keying charges | \$77.00 |
| DG164 | Hardware prepared for DG1-6300 Lg. Format IC cores, supplied with temporary keyed construction cores | \$77.00 |
| DG2 | Patented Degree DG2 Key System incorporating a locking sidebar | \$58.00/cyl. |
| DG260 | Hardware prepared for DG2-6300 Lg. Format IC cores, supplied with temporary plastic construction cores | No addition |
| DG263 | Patented Degree DG2 Large Format Interchangeable Core Cylinder - Includes master keying charges | \$135.00 |
| DG264 | Hardware prepared for DG2-6300 Lg. Format IC cores, supplied with temporary keyed construction cores | \$77.00 |
| DG3 | Patented Degree DG3 Key System incorporating a locking sidebar and UL437 listed | \$82.00/cyl. |
| DG360 | Hardware prepared for DG3-6300 Lg. Format IC cores, supplied with temporary plastic construction cores | No addition |
| DG363 | Patented Degree DG3 Large Format Interchangeable Core Cylinder - Includes master keying charges | \$159.00 |
| DG364 | Hardware prepared for DG3-6300 Lg. Format IC cores, supplied with temporary keyed construction cores | \$77.00 |
| IDP | Integrated Door Position Switch | \$100.00 |
| LB | Extra large thumbturn | \$16.00 |
| LC | Less Cylinder | -\$89.00/cyl. |
| OBS | Open Back Strike | \$73.00 |
| PHR | Deadbolt Privacy Function (available w/deadbolt function only) | \$100.00 |
| R01 | Mercury and Lenel compatible 1KΩ/2KΩ resistance supervision | \$100.00 |
| R03 | Software House compatible 1KΩ/2KΩ resistance supervision | \$100.00 |
| R04 | AMAG compatible 4-state supervision | \$100.00 |
| SC▲† | Schlage "C" Keyway cylinder, (Number 41 Cylinder Only, 0 bitted) | No addition |
| SE▲† | Schlage "E" Keyway cylinder, (Number 41 Cylinder Only, 0 bitted) | No addition |
| SG | MicroShield® – an antimicrobial powder coat finish | \$67.00 |
| WBS | Wrought Box Strike | No addition |

NOTES: ▲ Options not avail. with a standard 50 function lockout cylinder. † Not avail. with 60, 63, 64 options
CPC Clear Powder Coat over 26D/32D – 8205 x LNA x RH x 32D x CPC \$62.00
All orders will continue to be handled as a "special" when CPC is ordered.

USA & Canada Prices Effective June 3, 2019

Rose Design:

CO (2-3/4")
CR (2-3/16")
LN (2")
O (2-3/4")
TO (2-3/4")
TR (2-3/16")
E2 (2-11/16")
E3 (2-1/16")
E4 (3-1/4")

Studio Lever Series Designs:

All Studio Collection Levers Except for Gramercy, Wooster Square, & Grant Park
* Following levers not available in 32 & 32D: MA, MC, MH, MK, MM, MN, MO, MP, MQ, MS, MT, MU, MV, MX, MY, MZ, NS, NU

How to order:

NAC 82270-12V x CRMD x RH x 26D
Option 21
Function 8205
Rose CR
Lever MD
Hand RH
Finish 26D

| NAC 8200 Electrified Mortise Locks with High Security Monitoring | | | | 10BE/26D/ BSP/WSP | 03/04/09/10/ 10B/10BL/14/15/ 20D/26/*32/*32D |
|--|----------------|------------------------|--------------------------------------|----------------------|--|
| Option | Function | Trim - Proximity Entry | Description | | |
| NAC | 82270-12V/-24V | Rose x Lever Design | Fail Safe w/Cylinder Override | \$1,377.00 | \$1,401.00 |
| NAC | 82271-12V/-24V | Rose x Lever Design | Fail Secure w/Cylinder Override | | |
| NAC | 82280-12V/-24V | Rose x Lever Design | Fail Safe w/Deadbolt w/Cyl.Override | \$1,452.00 | \$1,476.00 |
| NAC | 82281-12V/-24V | Rose x Lever Design | Fail Secure w/D.bolt w/Cyl.Override | | |
| NAC | 82274-12V/-24V | Rose x Lever Design | Fail Safe - No Cylinder | \$1,322.00 | \$1,346.00 |
| NAC | 82275-12V/-24V | Rose x Lever Design | Fail Secure - No Cylinder | | |
| NAC | 82284-12V/-24V | Rose x Lever Design | Fail Safe w/Deadbolt - No Cylinder | \$1,397.00 | \$1,421.00 |
| NAC | 82285-12V/-24V | Rose x Lever Design | Fail Secure w/Deadbolt - No Cylinder | | |

Note: Consult catalog for ordering information.

Specify hand and voltage (12v or 24v) when ordering

ML-50 MORTISE LOCKS

SARGENT®

ASSA ABLOY

OPTIONS

USA & Canada Prices Effective June 3, 2019

| Options | Description | Price |
|---------------|---|--|
| 1▲ | 8200 Line with 1-1/16" wide front for 1-3/8" doors. | \$58.00 |
| 3 | Stainless steel hub (not available with 8289, 8291 & 8292 functions) | \$63.00 |
| 10▲ | SARGENT Signature Key System | \$58.00 / cyl. |
| 11†▲ | SARGENT XC Key System (not available with 10, 22, SC, SE options) | No addition |
| 1160 | SARGENT XC Large Format Interchangeable Plastic Disposable Construction Core | No addition |
| 1163 | SARGENT XC Large Format Interchangeable Core Cylinder - Includes masterkeying charges | \$77.00 |
| 1164 | SARGENT XC Large Format Interchangeable Construction Core Cylinder | \$77.00 |
| 1170 | Small Format interchangeable disposable construction core - to accept 7 Pin XC permanent core | No addition |
| 11727P | Small Format interchangeable keyed construction core - to accept 7 Pin XC permanent core | \$69.00 |
| 11737P | Small Format interchangeable core - to accept 7 pin XC permanent core | \$69.00 /cyl. |
| 21▲† | SARGENT Construction Key System (lost ball) Standard on all new systems established since 5/1/96 | \$16.00 / cyl. |
| 22▲† | SARGENT Construction Key System (split key) To be used on pre-established split key systems only | \$32.00 / cyl. |
| 23 | Locksets with flat 4 7/8" ANSI strike | No addition |
| 31 | Thick Doors - Extended Lip Required - Specify Length C to E - Cylinders - IMPORTANT- See catalog 7800/8200 option page for cylinder limitations - Below charges DO NOT include additional charges for special cylinder requirements | No addition |
| | Doors up to 2-1/2" thick - lock centered | No addition |
| | Doors 2-5/8" to 6" thick OR doors 1-3/4" thick w/max 1" paneling one side. For example: Specify 1-3/4" door with panel (Side) on inside or outside | Non Keyed function \$50.00 Keyed function \$100.00 |
| 60 | SARGENT Large Format Interchangeable Plastic Disposable Construction Core | No addition |
| 63 | SARGENT Large Format Interchangeable core cylinder, includes master keying charges | \$77.00 / cyl. |
| 64 | SARGENT Large Format Interchangeable Construction Core Cylinder | \$77.00 |
| 6573▲† | Small Format 6-Pin Uncombined Core (Refer to CK-12) | \$59.00 / cyl. |
| 65737P▲† | Small Format 7-Pin Uncombined Core (Refer to CK-12) | \$59.00 / cyl. |
| 68 | 8200 Line furnished with lever handle outside x knob inside (Excludes SLD Detention Knob) | Defaults to 8200 Lever Lock Price |
| 69 | 8200 Line furnished with lever handle inside x knob outside (Excludes SLD Detention Knob) | Defaults to 8200 Lever Lock Price |
| 70▲† | Small Format Interchangeable disposable plastic construction core | No addition |
| 72▲† | Small Format Interchangeable 6-pin construction core (7-pin with 11 option) | \$69.00 |
| 73▲† | Small Format interchangeable core 6-pin Includes MK and GMK keying charges | \$69.00 / cyl |
| 737P▲† | Small Format interchangeable core 7-pin (refer to CK-12 for available keyways) Includes MK and GMK keying charges | \$69.00 / cyl |
| 81▲† | Cylinder to accept Keso (83) and Keso F1 (F183) removable core – no core provided | No addition |
| F182† | SARGENT Keso Security Cylinder – patented – new key systems | \$84.00 / cyl. |
| F183▲† | SARGENT Keso Security Removable Core Cylinder – patented – new key systems | \$120.00 / cyl. |
| 82† | SARGENT Keso Security Cylinder (For existing systems only) | \$84.00 / cyl. |
| 83▲† | SARGENT Keso Security Removable Core Cylinder (For existing systems only) | \$120.00 / cyl. |
| 84▲† | SARGENT Keso Security Removable Construction Core Cylinder | See CK-18 |
| 85 | Tactile Warning - Abrasive coating on inside lever | \$45.00 |
| 86 | Tactile Warning - Abrasive coating on outside lever | \$45.00 |
| 87 | Tactile Warning - Abrasive coating on both levers | \$90.00 |
| AV | Anti Vandal Pull Trim (available in 32D finish), (Not available with 8270, 8271, 8272, 8273 functions) | \$212.00 |
| BR | SARGENT Bump Resistant Cylinders (N/A w/10, 22, 30, 60, 63, 64, 70, 72, 73, 737P, KESO, SC, & SE options) | \$23.00 /cyl. |
| DG1 | Patented Degree DG1 Key System | No Addition |
| DG160 | Hardware prepared for DG1-6300 Lg. Format IC cores, supplied with temporary plastic construction cores | No addition |
| DG163 | Patented Degree DG1 Large Format Interchangeable Core Cylinder - Includes master keying charges | \$77.00 |
| DG164 | Hardware prepared for DG1-6300 Lg. Format IC cores, supplied with temporary keyed construction cores | \$77.00 |
| DG2 | Patented Degree DG2 Key System incorporating a locking sidebar | \$58.00/cyl. |
| DG260 | Hardware prepared for DG2-6300 Lg. Format IC cores, supplied with temporary plastic construction cores | No addition |
| DG263 | Patented Degree DG2 Large Format Interchangeable Core Cylinder - Includes master keying charges | \$135.00 |
| DG264 | Hardware prepared for DG2-6300 Lg. Format IC cores, supplied with temporary keyed construction cores | \$77.00 |
| DG3 | Patented Degree DG3 Key System incorporating a locking sidebar and UL437 listed | \$82.00/cyl. |
| DG360 | Hardware prepared for DG3-6300 Lg. Format IC cores, supplied with temporary plastic construction cores | No addition |
| DG363 | Patented Degree DG3 Large Format Interchangeable Core Cylinder - Includes master keying charges | \$159.00 |
| DG364 | Hardware prepared for DG3-6300 Lg. Format IC cores, supplied with temporary keyed construction cores | \$77.00 |
| DX | Deadbolt Monitoring (not available with 50, 74) | \$182.00 |
| EMA* | "Lock" directional arrow engraving provided for outside LE1 escutcheon trim only | \$44.00 |
| EMB* | "Lock" directional arrow engraving provided for inside LE1 escutcheon trim only | \$44.00 |
| EMC* | "Lock" directional arrow engraving provided for both sides of LE1 escutcheon trim | \$88.00 |
| LB | Extra large thumbturn | \$16.00 |
| LC | Less Cylinder | -\$89.00/cyl. |
| LX | Latchbolt Monitor – available with all non-deadbolt functions; not available with DX option | \$185.00 |
| OBS | Open Back Strike | \$73.00 |
| RX | Request to Exit | \$190.00 |
| SC▲† | Schlage "C" Keyway cylinder, (Number 41 Cylinder Only, 0 bitted) | No addition |
| SE▲† | Schlage "E" Keyway cylinder, (Number 41 Cylinder Only, 0 bitted) | No addition |
| SG | MicroShield® – an antimicrobial powder coat finish | \$67.00 |
| VNA | Status indicator provided for the outside LE1 escutcheon trim only | \$92.00 |
| VNB | Status indicator provided for the inside LE1 escutcheon trim only | \$92.00 |
| VNC | Status indicators provided for both sides of LE1 escutcheon trim | \$184.00 |
| WBS | Wrought Box Strike | No addition |
| NOTES: | ▲ Options not avail. with a standard 50 function lockout cylinder. † Not avail. with 60, 63, 64 options | |
| CPC | Clear Powder Coat over 26D/32D – 8205 x CEH001 x RH x 32D x CPC All orders will continue to be handled as a "special" when CPC is ordered. | \$62.00 |

ASSA ABLOY

8200 STUDIO COLLECTION WOOSTER SQUARE

Escutcheon Designs:

CE
TE
LE1

Lever Design:
H001, H002



H001



H002

How to order:

21-8205 x CEH001x RH x 10BE
Option 21
Function 8205
Rose CE
Lever H001
Hand RH
Finish 10BE

USA & Canada Prices Effective June 3, 2019

| Function | | Finish | |
|---|------------------------------------|------------------|--|
| | | 10BE/26D/BSP/WSP | 03/04/09/10/10B/10BL/14/15/20D/26/32/32D |
| Single Cyl | | | |
| 8204 | Storeroom or Closet | | |
| 8205 | Office or Entry | | |
| 8237 | Classroom | \$1,184.00 | \$1,208.00 |
| 8255 | Office or Entry | | |
| 8206 | Storeroom or Service | | |
| 8231 | Utility | | |
| 8236 | Closet | | |
| 8256 | Office or Inner Entry | \$1,206.00 | \$1,230.00 |
| 8257, 8258, 8267 | Institutional Privacy | | |
| 8289 | Holdback | | |
| 8291 | All Purpose Holdback | | |
| Single Cyl With Deadbolt | | | |
| 8224 | Room Door | | |
| 8225 | Dormitory or Exit | | |
| 8227 | Closet or Storeroom | | |
| 8228, 8230 | Dummy Trim Deadlock | | |
| 8235 | Storeroom | \$1,233.00 | \$1,257.00 |
| 8243 | Apartment Corridor | | |
| 8245 | Dormitory or Exit | | |
| 8247 | Front Door or Apartment Corridor | | |
| 8251 | Storeroom Deadbolt | | |
| 8250 | Hotel Guest Lock | \$1,264.00 | \$1,288.00 |
| Double Cyl No Deadbolt | | | |
| 8216 | Apartment or Exit or Public Toilet | | |
| 8217 | Asylum or Institutional | | |
| 8238 | Classroom Security Intruder | \$1,282.00 | \$1,306.00 |
| 8259 | School Security | | |
| 8290 | Classroom Security Holdback | | |
| 8292 | All Purpose Holdback | | |
| Double Cyl With Deadbolt | | | |
| 8226 | Store Door | | |
| 8229 | Dummy Trim Deadlock | | |
| 8239, 8240 | Classroom Security Intruder | | |
| 8241 | Classroom Security | \$1,303.00 | \$1,327.00 |
| 8246 | Dormitory or Exit | | |
| 8248 | Store Door | | |
| 8249 | Security Deadbolt | | |
| 8252 | Institutional | | |
| Electro Mechanical Single Cyl – Specify 12V or 24V | | | |
| 8270-12V / 8270-24V | Fail Safe | \$1,380.00 | \$1,404.00 |
| 8271-12V / 8271-24V | Fail Secure | | |
| Electro Mechanical Double Cyl – Specify 12V or 24V | | | |
| 8272-12V / 8272-24V | Fail Safe | \$1,437.00 | \$1,461.00 |
| 8273-12V / 8273-24V | Fail Secure | | |
| Non Keyed | | | |
| 8213 | Communication or Exit | \$1,033.00 | \$1,057.00 |
| 8215 | Passage or Closet | | |
| 8265 | Privacy Bedroom or Bath (Latch) | \$1,131.00 | \$1,155.00 |
| 8266, 8268 | Privacy Bedroom or Bath (Deadbolt) | \$1,164.00 | \$1,188.00 |
| 8293* | Single Dummy Trim | \$419.00 | \$443.00 |
| 8294 | Double Dummy Trim | \$863.00 | \$887.00 |
| 8295 | Single Dummy Trim w/Lockbody | \$508.00 | \$532.00 |
| 8296 | Double Dummy Trim w/Lockbody | \$956.00 | \$980.00 |
| 8297 | Double Dummy w/Active Trim | \$1,033.00 | \$1,057.00 |

ML-52 MORTISE LOCKS

SARGENT®

ASSA ABLOY

OPTIONS

USA & Canada Prices Effective June 3, 2019

| Options | Description | Price |
|----------|---|-----------------------------------|
| 1▲ | 8200 Line with 1-1/16" wide front for 1-3/8" doors. | \$58.00 |
| 3 | Stainless steel hub (not available with 8289, 8291 & 8292 functions) | \$63.00 |
| 10▲ | SARGENT Signature Key System | \$58.00 / cyl. |
| 11†▲ | SARGENT XC Key System (not available with 10, 22, SC, SE options) | No addition |
| 1160 | SARGENT XC Large Format Interchangeable Plastic Disposable Construction Core | No addition |
| 1163 | SARGENT XC Large Format Interchangeable Core Cylinder - Includes masterkeying charges | \$77.00 |
| 1164 | SARGENT XC Large Format Interchangeable Construction Core Cylinder | \$77.00 |
| 1170 | Small Format interchangeable disposable construction core - to accept 7 Pin XC permanent core | No addition |
| 11727P | Small Format interchangeable keyed construction core - to accept 7 Pin XC permanent core | \$69.00 |
| 11737P | Small Format interchangeable core - to accept 7 pin XC permanent core | \$69.00 /cyl. |
| 21▲† | SARGENT Construction Key System (lost ball) Standard on all new systems established since 5/1/96 | \$16.00 / cyl. |
| 22▲† | SARGENT Construction Key System (split key) To be used on pre-established split key systems only | \$32.00 / cyl. |
| 23 | Locksets with flat 4 7/8" ANSI strike | No addition |
| 31 | Thick Doors - Extended Lip Required - Specify Length C to E | |
| | - Cylinders - IMPORTANT- See catalog 7800/8200 option page for cylinder limitations | |
| | - Below charges DO NOT include additional charges for special cylinder requirements | |
| | Doors up to 2-1/2" thick - lock centered | No addition |
| | Doors 2-5/8" to 6" thick OR doors 1-3/4" thick w/max 1" paneling one side. | |
| | For example: Specify 1-3/4" door with panel (Side) on inside or outside | |
| | Non Keyed function \$50.00 Keyed function \$100.00 | |
| 60 | SARGENT Large Format Interchangeable Plastic Disposable Construction Core | No addition |
| 63 | SARGENT Large Format Interchangeable core cylinder, includes master keying charges | \$77.00 / cyl. |
| 64 | SARGENT Large Format Interchangeable Construction Core Cylinder | \$77.00 |
| 6573▲† | Small Format 6-Pin Uncombined Core (Refer to CK-12) | \$59.00 / cyl. |
| 65737P▲† | Small Format 7-Pin Uncombined Core (Refer to CK-12) | \$59.00 / cyl. |
| 68 | 8200 Line furnished with lever handle outside x knob inside (Excludes SLD Detention Knob) | Defaults to 8200 Lever Lock Price |
| 69 | 8200 Line furnished with lever handle inside x knob outside (Excludes SLD Detention Knob) | Defaults to 8200 Lever Lock Price |
| 70▲† | Small Format Interchangeable disposable plastic construction core | No addition |
| 72▲† | Small Format Interchangeable 6-pin construction core (7-pin with 11 option) | \$69.00 |
| 73▲† | Small Format interchangeable core 6-pin Includes MK and GMK keying charges | \$69.00 / cyl |
| 737P▲† | Small Format interchangeable core 7-pin (refer to CK-12 for available keyways) Includes MK and GMK keying charges | \$69.00 / cyl |
| 81▲† | Cylinder to accept Keso (83) and Keso F1 (F183) removable core – no core provided | No addition |
| F182† | SARGENT Keso Security Cylinder – patented – new key systems | \$84.00 / cyl. |
| F183▲† | SARGENT Keso Security Removable Core Cylinder – patented – new key systems | \$120.00 / cyl. |
| 82† | SARGENT Keso Security Cylinder (For existing systems only) | \$84.00 / cyl. |
| 83▲† | SARGENT Keso Security Removable Core Cylinder (For existing systems only) | \$120.00 / cyl. |
| 84▲† | SARGENT Keso Security Removable Construction Core Cylinder | See CK-18 |
| 85 | Tactile Warning - Abrasive coating on inside lever | \$45.00 |
| 86 | Tactile Warning - Abrasive coating on outside lever | \$45.00 |
| 87 | Tactile Warning - Abrasive coating on both levers | \$90.00 |
| AV | Anti Vandal Pull Trim (available in 32D finish), (Not available with 8270, 8271, 8272, 8273 functions) | \$212.00 |
| BR | SARGENT Bump Resistant Cylinders (N/A w/10, 22, 30, 60, 63, 64, 70, 72, 73, 737P, KESO, SC, & SE options) | \$23.00 /cyl. |
| DG1 | Patented Degree DG1 Key System | No Addition |
| DG160 | Hardware prepared for DG1-6300 Lg. Format IC cores, supplied with temporary plastic construction cores | No addition |
| DG163 | Patented Degree DG1 Large Format Interchangeable Core Cylinder - Includes master keying charges | \$77.00 |
| DG164 | Hardware prepared for DG1-6300 Lg. Format IC cores, supplied with temporary keyed construction cores | \$77.00 |
| DG2 | Patented Degree DG2 Key System incorporating a locking sidebar | \$58.00/cyl. |
| DG260 | Hardware prepared for DG2-6300 Lg. Format IC cores, supplied with temporary plastic construction cores | No addition |
| DG263 | Patented Degree DG2 Large Format Interchangeable Core Cylinder - Includes master keying charges | \$135.00 |
| DG264 | Hardware prepared for DG2-6300 Lg. Format IC cores, supplied with temporary keyed construction cores | \$77.00 |
| DG3 | Patented Degree DG3 Key System incorporating a locking sidebar and UL437 listed | \$82.00/cyl. |
| DG360 | Hardware prepared for DG3-6300 Lg. Format IC cores, supplied with temporary plastic construction cores | No addition |
| DG363 | Patented Degree DG3 Large Format Interchangeable Core Cylinder - Includes master keying charges | \$159.00 |
| DG364 | Hardware prepared for DG3-6300 Lg. Format IC cores, supplied with temporary keyed construction cores | \$77.00 |
| DX | Deadbolt Monitoring (not available with 50, 74) | \$182.00 |
| EMA* | "Lock" directional arrow engraving provided for outside LE1 escutcheon trim only | \$44.00 |
| EMB* | "Lock" directional arrow engraving provided for inside LE1 escutcheon trim only | \$44.00 |
| EMC* | "Lock" directional arrow engraving provided for both sides of LE1 escutcheon trim | \$88.00 |
| LB | Extra large thumbturn | \$16.00 |
| LC | Less Cylinder | -\$89.00/cyl. |
| LX | Latchbolt Monitor – available with all non-deadbolt functions; not available with DX option | \$185.00 |
| OBS | Open Back Strike | \$73.00 |
| RX | Request to Exit | \$190.00 |
| SC▲† | Schlage "C" Keyway cylinder, (Number 41 Cylinder Only, 0 bitting) | No addition |
| SE▲† | Schlage "E" Keyway cylinder, (Number 41 Cylinder Only, 0 bitting) | No addition |
| SG | MicroShield® – an antimicrobial powder coat finish | \$67.00 |
| VNA | Status indicator provided for the outside LE1 escutcheon trim only | \$92.00 |
| VNB | Status indicator provided for the inside LE1 escutcheon trim only | \$92.00 |
| VNC | Status indicators provided for both sides of LE1 escutcheon trim | \$184.00 |
| WBS | Wrought Box Strike | No addition |

NOTES: ▲ Options not avail. with a standard 50 function lockout cylinder. † Not avail. with 60, 63, 64 options

| | | |
|-----|--|---------|
| CPC | Clear Powder Coat over 26D/32D – 8205 x CEH010 x RH x 32D x CPC | \$62.00 |
| | All orders will continue to be handled as a "special" when CPC is ordered. | |

ASSA ABLOY

8200 STUDIO COLLECTION WOOSTER SQUARE & GRANT PARK

Escutcheon Designs:
CE
TE
LE1

Lever Design:

H003, H004, H005, H006, H007,
H008, H009, H010, H011



H010



H011

How to order:

21-8205 x CEH003 x RH x 10BE
Option 21
Function 8205
Rose CE
Lever H010
Hand RH
Finish 10BE

USA & Canada Prices Effective June 3, 2019

| Function | | Finish | |
|---|------------------------------------|------------------|--|
| | | 10BE/26D/BSP/WSP | 03/04/09/10/10B/10BL/14/15/20D/26/32/32D |
| Single Cyl | | | |
| 8204 | Storeroom or Closet | | |
| 8205 | Office or Entry | | |
| 8237 | Classroom | \$1,260.00 | \$1,284.00 |
| 8255 | Office or Entry | | |
| 8206 | Storeroom or Service | | |
| 8231 | Utility | | |
| 8236 | Closet | | |
| 8256 | Office or Inner Entry | \$1,281.00 | \$1,305.00 |
| 8257, 8258, 8267 | Institutional Privacy | | |
| 8289 | Holdback | | |
| 8291 | All Purpose Holdback | | |
| Single Cyl With Deadbolt | | | |
| 8224 | Room Door | | |
| 8225 | Dormitory or Exit | | |
| 8227 | Closet or Storeroom | | |
| 8228, 8230 | Dummy Trim Deadlock | | |
| 8235 | Storeroom | \$1,309.00 | \$1,333.00 |
| 8243 | Apartment Corridor | | |
| 8245 | Dormitory or Exit | | |
| 8247 | Front Door or Apartment Corridor | | |
| 8251 | Storeroom Deadbolt | | |
| 8250 | Hotel Guest Lock | \$1,338.00 | \$1,362.00 |
| Double Cyl No Deadbolt | | | |
| 8216 | Apartment or Exit or Public Toilet | | |
| 8217 | Asylum or Institutional | | |
| 8238 | Classroom Security Intruder | \$1,357.00 | \$1,381.00 |
| 8259 | School Security | | |
| 8290 | Classroom Security Holdback | | |
| 8292 | All Purpose Holdback | | |
| Double Cyl With Deadbolt | | | |
| 8226 | Store Door | | |
| 8229 | Dummy Trim Deadlock | | |
| 8239, 8240 | Classroom Security Intruder | | |
| 8241 | Classroom Security | \$1,376.00 | \$1,400.00 |
| 8246 | Dormitory or Exit | | |
| 8248 | Store Door | | |
| 8249 | Security Deadbolt | | |
| 8252 | Institutional | | |
| Electro Mechanical Single Cyl – Specify 12V or 24V | | | |
| 8270-12V / 8270-24V | Fail Safe | \$1,456.00 | \$1,480.00 |
| 8271-12V / 8271-24V | Fail Secure | | |
| Electro Mechanical Double Cyl – Specify 12V or 24V | | | |
| 8272-12V / 8272-24V | Fail Safe | \$1,513.00 | \$1,537.00 |
| 8273-12V / 8273-24V | Fail Secure | | |
| Non Keyed | | | |
| 8213 | Communication or Exit | \$1,106.00 | \$1,130.00 |
| 8215 | Passage or Closet | | |
| 8265 | Privacy Bedroom or Bath (Latch) | \$1,206.00 | \$1,230.00 |
| 8266, 8268 | Privacy Bedroom or Bath (Deadbolt) | \$1,238.00 | \$1,262.00 |
| 8293* | Single Dummy Trim | \$493.00 | \$517.00 |
| 8294 | Double Dummy Trim | \$937.00 | \$961.00 |
| 8295 | Single Dummy Trim w/Lockbody | \$582.00 | \$606.00 |
| 8296 | Double Dummy Trim w/Lockbody | \$1,028.00 | \$1,052.00 |
| 8297 | Double Dummy w/Active Trim | \$1,106.00 | \$1,130.00 |

ML-54 MORTISE LOCKS

SARGENT®

ASSA ABLOY

OPTIONS

USA & Canada Prices Effective June 3, 2019

| Options | Description | Price |
|---|---|-----------------|
| 1▲ | 8200 Line with 1-1/16" wide front for 1-3/8" doors. | \$58.00 |
| 3 | Stainless steel hub (not available with 8289, 8291 & 8292 functions) | \$63.00 |
| 10▲ | SARGENT Signature Key System | \$58.00 / cyl. |
| 11†▲ | SARGENT XC Key System (not available with 10, 22, SC, SE options) | No addition |
| 1160 | SARGENT XC Large Format Interchangeable Plastic Disposable Construction Core | No addition |
| 1163 | SARGENT XC Large Format Interchangeable Core Cylinder - Includes masterkeying charges | \$77.00 |
| 1164 | SARGENT XC Large Format Interchangeable Construction Core Cylinder | \$77.00 |
| 1170 | Small Format interchangeable disposable construction core - to accept 7 Pin XC permanent core | No addition |
| 11727P | Small Format interchangeable keyed construction core - to accept 7 Pin XC permanent core | \$69.00 |
| 11737P | Small Format interchangeable core - to accept 7 pin XC permanent core | \$69.00 /cyl. |
| 21▲† | SARGENT Construction Key System (lost ball) Standard on all new systems established since 5/1/96 | \$16.00 / cyl. |
| 22▲† | SARGENT Construction Key System (split key) To be used on pre-established split key systems only | \$32.00 / cyl. |
| 23 | Locksets with flat 4 7/8" ANSI strike | No addition |
| 31 | Thick Doors - Extended Lip Required - Specify Length C to E - Cylinders - IMPORTANT- See catalog 7800/8200 option page for cylinder limitations - Below charges DO NOT include additional charges for special cylinder requirements Doors up to 2-1/2" thick - lock centered Doors 2-5/8" to 6" thick OR doors 1-3/4" thick w/max 1" paneling one side. For example: Specify 1-3/4" door with panel (Side) on inside or outside Non Keyed function \$50.00 Keyed function \$100.00 | No addition |
| 60 | SARGENT Large Format Interchangeable Plastic Disposable Construction Core | No addition |
| 63 | SARGENT Large Format Interchangeable core cylinder, includes master keying charges | \$77.00 / cyl. |
| 64 | SARGENT Large Format Interchangeable Construction Core Cylinder | \$77.00 |
| 6573▲† | Small Format 6-Pin Uncombined Core (Refer to CK-12) | \$59.00 / cyl. |
| 65737P▲† | Small Format 7-Pin Uncombined Core (Refer to CK-12) | \$59.00 / cyl. |
| 68 | 8200 Line furnished with lever handle outside x knob inside (Excludes SLD Detention Knob) Defaults to 8200 Lever Lock Price | |
| 69 | 8200 Line furnished with lever handle inside x knob outside (Excludes SLD Detention Knob) Defaults to 8200 Lever Lock Price | |
| 70▲† | Small Format Interchangeable disposable plastic construction core | No addition |
| 72▲† | Small Format Interchangeable 6-pin construction core (7-pin with 11 option) | \$69.00 |
| 73▲† | Small Format interchangeable core 6-pin Includes MK and GMK keying charges | \$69.00 / cyl |
| 737P▲† | Small Format interchangeable core 7-pin (refer to CK-12 for available keyways) Includes MK and GMK keying charges | \$69.00 / cyl |
| 81▲† | Cylinder to accept Keso (83) and Keso F1 (F183) removable core – no core provided | No addition |
| F182† | SARGENT Keso Security Cylinder – patented – new key systems | \$84.00 / cyl. |
| F183▲† | SARGENT Keso Security Removable Core Cylinder – patented – new key systems | \$120.00 / cyl. |
| 82† | SARGENT Keso Security Cylinder (For existing systems only) | \$84.00 / cyl. |
| 83▲† | SARGENT Keso Security Removable Core Cylinder (For existing systems only) | \$120.00 / cyl. |
| 84▲† | SARGENT Keso Security Removable Construction Core Cylinder | See CK-18 |
| 85 | Tactile Warning - Abrasive coating on inside lever | \$45.00 |
| 86 | Tactile Warning - Abrasive coating on outside lever | \$45.00 |
| 87 | Tactile Warning - Abrasive coating on both levers | \$90.00 |
| AV | Anti Vandal Pull Trim (available in 32D finish), (Not available with 8270, 8271, 8272, 8273 functions) | \$212.00 |
| BR | SARGENT Bump Resistant Cylinders (N/A w/10, 22, 30, 60, 63, 64, 70, 72, 73, 737P, KESO, SC, & SE options) | \$23.00 /cyl. |
| DG1 | Patented Degree DG1 Key System | No Addition |
| DG160 | Hardware prepared for DG1-6300 Lg. Format IC cores, supplied with temporary plastic construction cores | No addition |
| DG163 | Patented Degree DG1 Large Format Interchangeable Core Cylinder - Includes master keying charges | \$77.00 |
| DG164 | Hardware prepared for DG1-6300 Lg. Format IC cores, supplied with temporary keyed construction cores | \$77.00 |
| DG2 | Patented Degree DG2 Key System incorporating a locking sidebar | \$58.00/cyl. |
| DG260 | Hardware prepared for DG2-6300 Lg. Format IC cores, supplied with temporary plastic construction cores | No addition |
| DG263 | Patented Degree DG2 Large Format Interchangeable Core Cylinder - Includes master keying charges | \$135.00 |
| DG264 | Hardware prepared for DG2-6300 Lg. Format IC cores, supplied with temporary keyed construction cores | \$77.00 |
| DG3 | Patented Degree DG3 Key System incorporating a locking sidebar and UL437 listed | \$82.00/cyl. |
| DG360 | Hardware prepared for DG3-6300 Lg. Format IC cores, supplied with temporary plastic construction cores | No addition |
| DG363 | Patented Degree DG3 Large Format Interchangeable Core Cylinder - Includes master keying charges | \$159.00 |
| DG364 | Hardware prepared for DG3-6300 Lg. Format IC cores, supplied with temporary keyed construction cores | \$77.00 |
| DX | Deadbolt Monitoring (not available with 50, 74) | \$182.00 |
| EMA* | "Lock" directional arrow engraving provided for outside LE1 escutcheon trim only | \$44.00 |
| EMB* | "Lock" directional arrow engraving provided for inside LE1 escutcheon trim only | \$44.00 |
| EMC* | "Lock" directional arrow engraving provided for both sides of LE1 escutcheon trim | \$88.00 |
| LB | Extra large thumbturn | \$16.00 |
| LC | Less Cylinder | -\$89.00/cyl. |
| LX | Latchbolt Monitor – available with all non-deadbolt functions; not available with DX option | \$185.00 |
| OBS | Open Back Strike | \$73.00 |
| RX | Request to Exit | \$190.00 |
| SC▲† | Schlage "C" Keyway cylinder, (Number 41 Cylinder Only, 0 bitted) | No addition |
| SE▲† | Schlage "E" Keyway cylinder, (Number 41 Cylinder Only, 0 bitted) | No addition |
| SG | MicroShield® – an antimicrobial powder coat finish | \$67.00 |
| VNA | Status indicator provided for the outside LE1 escutcheon trim only | \$92.00 |
| VNB | Status indicator provided for the inside LE1 escutcheon trim only | \$92.00 |
| VNC | Status indicators provided for both sides of LE1 escutcheon trim | \$184.00 |
| WBS | Wrought Box Strike | No addition |
| NOTES: ▲ Options not avail. with a standard 50 function lockout cylinder. † Not avail. with 60, 63, 64 options | | |
| CPC | Clear Powder Coat over 26D/32D – 8205 x CEMD x RH x 32D x CPC All orders will continue to be handled as a "special" when CPC is ordered. | \$62.00 |

ASSA ABLOY

8200 STUDIO COLLECTION

Escutcheon Designs: Studio Lever Designs:
 CE All Studio Collection Levers
 TE Except for Gramercy, Wooster
 LE1 Square, & Grant Park.

How to order: 21-8205 x CEMD x RH x 26D
 Option 21
 Function 8205
 Rose CE
 Lever MD
 Hand RH
 Finish 26D

USA & Canada
 Prices Effective
 June 3, 2019

| Function | | Finish | |
|---|------------------------------------|------------------|--|
| | | 10BE/26D/BSP/WSP | 03/04/09/10/10B/10BL/14/15/20D/26/32/32D |
| Single Cyl | | | |
| 8204 | Storeroom or Closet | | |
| 8205 | Office or Entry | | |
| 8237 | Classroom | \$1,054.00 | \$1,078.00 |
| 8255 | Office or Entry | | |
| <hr/> | | | |
| 8206 | Storeroom or Service | | |
| 8231 | Utility | | |
| 8236 | Closet | | |
| 8256 | Office or Inner Entry | \$1,075.00 | \$1,099.00 |
| 8257, 8258, 8267 | Institutional Privacy | | |
| 8289 | Holdback | | |
| 8291 | All Purpose Holdback | | |
| <hr/> | | | |
| Single Cyl With Deadbolt | | | |
| 8224 | Room Door | | |
| 8225 | Dormitory or Exit | | |
| 8227 | Closet or Storeroom | | |
| 8228, 8230 | Dummy Trim Deadlock | | |
| 8235 | Storeroom | \$1,104.00 | \$1,128.00 |
| 8243 | Apartment Corridor | | |
| 8245 | Dormitory or Exit | | |
| 8247 | Front Door or Apartment Corridor | | |
| 8251 | Storeroom Deadbolt | | |
| 8250 | Hotel Guest Lock | \$1,145.00 | \$1,169.00 |
| <hr/> | | | |
| Double Cyl No Deadbolt | | | |
| 8216 | Apartment or Exit or Public Toilet | | |
| 8217 | Asylum or Institutional | | |
| 8238 | Classroom Security Intruder | \$1,154.00 | \$1,178.00 |
| 8259 | School Security | | |
| 8290 | Classroom Security Holdback | | |
| 8292 | All Purpose Holdback | | |
| <hr/> | | | |
| Double Cyl With Deadbolt | | | |
| 8226 | Store Door | | |
| 8229 | Dummy Trim Deadlock | | |
| 8239, 8240 | Classroom Security Intruder | | |
| 8241 | Classroom Security | \$1,179.00 | \$1,203.00 |
| 8246 | Dormitory or Exit | | |
| 8248 | Store Door | | |
| 8249 | Security Deadbolt | | |
| 8252 | Institutional | | |
| <hr/> | | | |
| Electro Mechanical Single Cyl – Specify 12V or 24V | | | |
| 8270-12V / 8270-24V | Fail Safe | \$1,250.00 | \$1,274.00 |
| 8271-12V / 8271-24V | Fail Secure | | |
| <hr/> | | | |
| Electro Mechanical Double Cyl – Specify 12V or 24V | | | |
| 8272-12V / 8272-24V | Fail Safe | \$1,307.00 | \$1,331.00 |
| 8273-12V / 8273-24V | Fail Secure | | |
| <hr/> | | | |
| Non Keyed | | | |
| 8213 | Communication or Exit | \$843.00 | \$867.00 |
| 8215 | Passage or Closet | | |
| 8265 | Privacy Bedroom or Bath (Latch) | \$942.00 | \$966.00 |
| 8266, 8268 | Privacy Bedroom or Bath (Deadbolt) | \$997.00 | \$1,021.00 |
| 8293* | Single Dummy Trim | \$348.00 | \$360.00 |
| 8294 | Double Dummy Trim | \$695.00 | \$719.00 |
| 8295 | Single Dummy Trim w/Lockbody | \$444.00 | \$456.00 |
| 8296 | Double Dummy Trim w/Lockbody | \$792.00 | \$816.00 |
| 8297 | Double Dummy w/Active Trim | \$874.00 | \$898.00 |

ML-56 MORTISE LOCKS

SARGENT®

OPTIONS USA & Canada Prices Effective June 3, 2019

ASSA ABLOY

| Options | Description | Price |
|----------|---|-----------------------------------|
| 1▲ | 8200 Line with 1-1/16" wide front for 1-3/8" doors. | \$58.00 |
| 3 | Stainless steel hub (not available with 8289, 8291 & 8292 functions) | \$63.00 |
| 10▲ | SARGENT Signature Key System | \$58.00 / cyl. |
| 11†▲ | SARGENT XC Key System (not available with 10, 22, SC, SE options) | No addition |
| 1160 | SARGENT XC Large Format Interchangeable Plastic Disposable Construction Core | No addition |
| 1163 | SARGENT XC Large Format Interchangeable Core Cylinder - Includes masterkeying charges | \$77.00 |
| 1164 | SARGENT XC Large Format Interchangeable Construction Core Cylinder | \$77.00 |
| 1170 | Small Format interchangeable disposable construction core - to accept 7 Pin XC permanent core | No addition |
| 11727P | Small Format interchangeable keyed construction core - to accept 7 Pin XC permanent core | \$69.00 |
| 11737P | Small Format interchangeable core - to accept 7 pin XC permanent core | \$69.00 / cyl. |
| 21▲† | SARGENT Construction Key System (lost ball) Standard on all new systems established since 5/1/96 | \$16.00 / cyl. |
| 22▲† | SARGENT Construction Key System (split key) To be used on pre-established split key systems only | \$32.00 / cyl. |
| 23 | Locksets with flat 4 7/8" ANSI strike | No addition |
| 31 | Thick Doors - Extended Lip Required - Specify Length C to E | |
| | - Cylinders - IMPORTANT- See catalog 7800/8200 option page for cylinder limitations | |
| | - Below charges DO NOT include additional charges for special cylinder requirements | |
| | Doors up to 2-1/2" thick - lock centered | No addition |
| | Doors 2-5/8" to 6" thick OR doors 1-3/4" thick w/max 1" paneling one side. | |
| | For example: Specify 1-3/4" door with panel (Side) on inside or outside | |
| | Non Keyed function \$50.00 Keyed function \$100.00 | |
| 60 | SARGENT Large Format Interchangeable Plastic Disposable Construction Core | No addition |
| 63 | SARGENT Large Format Interchangeable core cylinder, includes master keying charges | \$77.00 / cyl. |
| 64 | SARGENT Large Format Interchangeable Construction Core Cylinder | \$77.00 |
| 6573▲† | Small Format 6-Pin Uncombined Core (Refer to CK-12) | \$59.00 / cyl. |
| 65737P▲† | Small Format 7-Pin Uncombined Core (Refer to CK-12) | \$59.00 / cyl. |
| 68 | 8200 Line furnished with lever handle outside x knob inside (Excludes SLD Detention Knob) | Defaults to 8200 Lever Lock Price |
| 69 | 8200 Line furnished with lever handle inside x knob outside (Excludes SLD Detention Knob) | Defaults to 8200 Lever Lock Price |
| 70▲† | Small Format interchangeable disposable plastic construction core | No addition |
| 72▲† | Small Format interchangeable 6-pin construction core (7-pin with 11 option) | \$69.00 |
| 73▲† | Small Format interchangeable core 6-pin Includes MK and GMK keying charges | \$69.00 / cyl |
| 737P▲† | Small Format interchangeable core 7-pin (refer to CK-12 for available keyways) Includes MK and GMK keying charges | \$69.00 / cyl |
| 81▲† | Cylinder to accept Keso (83) and Keso F1 (F183) removable core – no core provided | No addition |
| F182† | SARGENT Keso Security Cylinder – patented – new key systems | \$84.00 / cyl. |
| F183▲† | SARGENT Keso Security Removable Core Cylinder – patented – new key systems | \$120.00 / cyl. |
| 82† | SARGENT Keso Security Cylinder (For existing systems only) | \$84.00 / cyl. |
| 83▲† | SARGENT Keso Security Removable Core Cylinder (For existing systems only) | \$120.00 / cyl. |
| 84▲† | SARGENT Keso Security Removable Construction Core Cylinder | See CK-18 |
| 85 | Tactile Warning - Abrasive coating on inside lever | \$45.00 |
| 86 | Tactile Warning - Abrasive coating on outside lever | \$45.00 |
| 87 | Tactile Warning - Abrasive coating on both levers | \$90.00 |
| AV | Anti Vandal Pull Trim (available in 32D finish), (Not available with 8270, 8271, 8272, 8273 functions) | \$212.00 |
| BR | SARGENT Bump Resistant Cylinders (N/A w/10, 22, 30, 60, 63, 64, 70, 72, 73, 737P, KESO, SC, & SE options) | \$23.00 / cyl. |
| DG1 | Patented Degree DG1 Key System | No Addition |
| DG160 | Hardware prepared for DG1-6300 Lg. Format IC cores, supplied with temporary plastic construction cores | No addition |
| DG163 | Patented Degree DG1 Large Format Interchangeable Core Cylinder - Includes master keying charges | \$77.00 |
| DG164 | Hardware prepared for DG1-6300 Lg. Format IC cores, supplied with temporary keyed construction cores | \$77.00 |
| DG2 | Patented Degree DG2 Key System incorporating a locking sidebar | \$58.00/cyl. |
| DG260 | Hardware prepared for DG2-6300 Lg. Format IC cores, supplied with temporary plastic construction cores | No addition |
| DG263 | Patented Degree DG2 Large Format Interchangeable Core Cylinder - Includes master keying charges | \$135.00 |
| DG264 | Hardware prepared for DG2-6300 Lg. Format IC cores, supplied with temporary keyed construction cores | \$77.00 |
| DG3 | Patented Degree DG3 Key System incorporating a locking sidebar and UL437 listed | \$82.00/cyl. |
| DG360 | Hardware prepared for DG3-6300 Lg. Format IC cores, supplied with temporary plastic construction cores | No addition |
| DG363 | Patented Degree DG3 Large Format Interchangeable Core Cylinder - Includes master keying charges | \$159.00 |
| DG364 | Hardware prepared for DG3-6300 Lg. Format IC cores, supplied with temporary keyed construction cores | \$77.00 |
| EMA* | "Lock" directional arrow engraving provided for outside LE1 escutcheon trim only | \$44.00 |
| EMB* | "Lock" directional arrow engraving provided for inside LE1 escutcheon trim only | \$44.00 |
| EMC* | "Lock" directional arrow engraving provided for both sides of LE1 escutcheon trim | \$88.00 |
| IDP | Integrated Door Position Switch | \$100.00 |
| LB | Extra large thumbturn | \$16.00 |
| LC | Less Cylinder | -\$89.00/cyl. |
| OBS | Open Back Strike | \$73.00 |
| PHR | Deadbolt Privacy Function (available w/deadbolt function only) | \$100.00 |
| R01 | Mercury and Lenel compatible 1KΩ/2KΩ resistance supervision | \$100.00 |
| R03 | Software House compatible 1KΩ/2KΩ resistance supervision | \$100.00 |
| R04 | AMAG compatible 4-state supervision | \$100.00 |
| SC▲† | Schlage "C" Keyway cylinder, (Number 41 Cylinder Only, 0 bitted) | No addition |
| SE▲† | Schlage "E" Keyway cylinder, (Number 41 Cylinder Only, 0 bitted) | No addition |
| SG | MicroShield® – an antimicrobial powder coat finish | \$67.00 |
| VNA | Status indicator provided for the outside LE1 escutcheon trim only | \$92.00 |
| VNB | Status indicator provided for the inside LE1 escutcheon trim only | \$92.00 |
| VNC | Status indicators provided for both sides of LE1 escutcheon trim | \$184.00 |
| WBS | Wrought Box Strike | No addition |

NOTES: ▲ Options not avail. with a standard 50 function lockout cylinder. † Not avail. with 60, 63, 64 options

| | | |
|-----|--|---------|
| CPC | Clear Powder Coat over 26D/32D – NAC-82280-24V x CEMD x RH x 32D x CPC All orders will continue to be handled as a "special" when CPC is ordered. | \$62.00 |
|-----|--|---------|

ASSA ABLOY, the global leader
in door opening solutions

Copyright © 2002-2019 Sargent Manufacturing Company, an ASSA ABLOY Group company. All rights reserved.
Reproduction in whole or in part without the express written permission of Sargent Manufacturing Company is prohibited.
Contact us at: 800-727-5477 or visit www.sargentlock.com. In Canada contact us at: 800-461-3007 or visit www.assaabloydss.ca

USA & Canada Prices Effective June 3, 2019

Escutcheon Designs:

CE
TE
LE1

Studio Lever Designs:

All Studio Collection Levers
Except for Gramercy, Wooster
Square, & Grant Park.

How to order: NAC-82280-24V x CEMD x RH x 26D

Option NAC
Function 82280-24V
Rose CE
Lever MD
Hand RH
Finish 26D

| NAC 8200 Electrified Mortise Locks with High Security Monitoring | | | | 10BE/26D/ BSP/WSP | 03/04/09/10/ 10B/10BL/14/15/ 20D/26/32/32D |
|--|----------------|------------------------|--------------------------------------|----------------------|--|
| Option | Function | Trim - Proximity Entry | Description | | |
| NAC | 82270-12V/-24V | Rose x Lever Design | Fail Safe w/Cylinder Override | \$1,425.00 | \$1,449.00 |
| NAC | 82271-12V/-24V | Rose x Lever Design | Fail Secure w/Cylinder Override | | |
| NAC | 82280-12V/-24V | Rose x Lever Design | Fail Safe w/Deadbolt w/Cyl.Override | \$1,500.00 | \$1,524.00 |
| NAC | 82281-12V/-24V | Rose x Lever Design | Fail Secure w/D.bolt w/Cyl.Override | | |
| NAC | 82274-12V/-24V | Rose x Lever Design | Fail Safe - No Cylinder | \$1,370.00 | \$1,394.00 |
| NAC | 82275-12V/-24V | Rose x Lever Design | Fail Secure - No Cylinder | | |
| NAC | 82284-12V/-24V | Rose x Lever Design | Fail Safe w/Deadbolt - No Cylinder | \$1,445.00 | \$1,469.00 |
| NAC | 82285-12V/-24V | Rose x Lever Design | Fail Secure w/Deadbolt - No Cylinder | | |

Note: Consult catalog for ordering information.

Specify hand and voltage (12v or 24v) when ordering

ML-58 MORTISE LOCKS

SARGENT®

ASSA ABLOY

OPTIONS

USA & Canada Prices Effective June 3, 2019

| Options | Description | Price |
|----------|---|---|
| 1▲ | 8200 Line with 1-1/16" wide front for 1-3/8" doors. | \$58.00 |
| 3 | Stainless steel hub (not available with 8289, 8291 & 8292 functions) | \$63.00 |
| 10▲ | SARGENT Signature Key System | \$58.00 / cyl. |
| 11†▲ | SARGENT XC Key System (not available with 10, 22, SC, SE options) | No addition |
| 1160 | SARGENT XC Large Format Interchangeable Plastic Disposable Construction Core | No addition |
| 1163 | SARGENT XC Large Format Interchangeable Core Cylinder - Includes masterkeying charges | \$77.00 |
| 1164 | SARGENT XC Large Format Interchangeable Construction Core Cylinder | \$77.00 |
| 1170 | Small Format interchangeable disposable construction core - to accept 7 Pin XC permanent core | No addition |
| 11727P | Small Format interchangeable keyed construction core - to accept 7 Pin XC permanent core | \$69.00 |
| 11737P | Small Format interchangeable core - to accept 7 pin XC permanent core | \$69.00 /cyl. |
| 21▲† | SARGENT Construction Key System (lost ball) Standard on all new systems established since 5/1/96 | \$16.00 / cyl. |
| 22▲† | SARGENT Construction Key System (split key) To be used on pre-established split key systems only | \$32.00 / cyl. |
| 23 | Locksets with flat 4 7/8" ANSI strike | No addition |
| 31 | Thick Doors - Extended Lip Required - Specify Length C to E - Cylinders - IMPORTANT- See catalog 7800/8200 option page for cylinder limitations - Below charges DO NOT include additional charges for special cylinder requirements | |
| | Doors up to 2-1/2" thick - lock centered | No addition |
| | Doors 2-5/8" to 6" thick OR doors 1-3/4" thick w/max 1" paneling one side. | |
| | For example: Specify 1-3/4" door with panel (Side) on inside or outside | Non Keyed function \$50.00 Keyed function \$100.00 |
| 49 | Visual Status Indicator - Available with 30, 36, 37 function - Rose Trims CR, E, L, LN, O, TR - Available with 26, 29, 38, 39 40, 41 functions - Rose Trim 8200 LN | \$92.00 |
| 49 | Occupancy Indicator with emergency Release - Available with 65, 66, 68 functions; Rose Trims 7800 CR, E, L, LN, O, TR | \$92.00 |
| 50 | Secured Indicator Rose- doors 1-5/8" to 2-1/4" thick- Avail.w/24,25,26,28,29,30,36,37,38,39,40,41,43,45,50,51,52,57,58,67 functions | \$62.00 |
| 60 | SARGENT Large Format Interchangeable Plastic Disposable Construction Core | No addition |
| 63 | SARGENT Large Format Interchangeable core cylinder, includes master keying charges | \$77.00 / cyl. |
| 64 | SARGENT Large Format Interchangeable Construction Core Cylinder | \$77.00 |
| 6573▲† | Small Format 6-Pin Uncombined Core (Refer to CK-12) | \$59.00 / cyl. |
| 65737P▲† | Small Format 7-Pin Uncombined Core (Refer to CK-12) | \$59.00 / cyl. |
| 68 | 8200 Line furnished with lever handle outside x knob inside (Excludes SLD Detention Knob) | Defaults to 8200 Lever Lock Price |
| 69 | 8200 Line furnished with lever handle inside x knob outside (Excludes SLD Detention Knob) | Defaults to 8200 Lever Lock Price |
| 70▲† | Small Format Interchangeable disposable plastic construction core | No addition |
| 72▲† | Small Format Interchangeable 6-pin construction core (7-pin with 11 option) | \$69.00 |
| 73▲† | Small Format interchangeable core 6-pin Includes MK and GMK keying charges | \$69.00 / cyl |
| 737P▲† | Small Format interchangeable core 7-pin (refer to CK-12 for available keyways) Includes MK and GMK keying charges | \$69.00 / cyl |
| 74 | Lock case wrapped in lead - handing required (roses not available) | \$272.00 |
| 81▲† | Cylinder to accept Keso (83) and Keso F1 (F183) removable core - no core provided | No addition |
| F182† | SARGENT Keso Security Cylinder - patented - new key systems | \$84.00 / cyl. |
| F183▲† | SARGENT Keso Security Removable Core Cylinder - patented - new key systems | \$120.00 / cyl. |
| 82† | SARGENT Keso Security Cylinder (For existing systems only) | \$84.00 / cyl. |
| 83▲† | SARGENT Keso Security Removable Core Cylinder (For existing systems only) | \$120.00 / cyl. |
| 84▲† | SARGENT Keso Security Removable Construction Core Cylinder | See CK-18 |
| AV | Anti Vandal Pull Trim (available in 32D finish), (Not available with 8270, 8271, 8272, 8273 functions) | \$212.00 |
| BR | SARGENT Bump Resistant Cylinders (N/A w/10, 22, 30, 60, 63, 64, 70, 72, 73, 737P, KESO, SC, & SE options) | \$23.00 /cyl. |
| DG1 | Patented Degree DG1 Key System | No Addition |
| DG160 | Hardware prepared for DG1-6300 Lg. Format IC cores, supplied with temporary plastic construction cores | No addition |
| DG163 | Patented Degree DG1 Large Format Interchangeable Core Cylinder - Includes master keying charges | \$77.00 |
| DG164 | Hardware prepared for DG1-6300 Lg. Format IC cores, supplied with temporary keyed construction cores | \$77.00 |
| DG2 | Patented Degree DG2 Key System incorporating a locking sidebar | \$58.00/cyl. |
| DG260 | Hardware prepared for DG2-6300 Lg. Format IC cores, supplied with temporary plastic construction cores | No addition |
| DG263 | Patented Degree DG2 Large Format Interchangeable Core Cylinder - Includes master keying charges | \$135.00 |
| DG264 | Hardware prepared for DG2-6300 Lg. Format IC cores, supplied with temporary keyed construction cores | \$77.00 |
| DG3 | Patented Degree DG3 Key System incorporating a locking sidebar and UL437 listed | \$82.00/cyl. |
| DG360 | Hardware prepared for DG3-6300 Lg. Format IC cores, supplied with temporary plastic construction cores | No addition |
| DG363 | Patented Degree DG3 Large Format Interchangeable Core Cylinder - Includes master keying charges | \$159.00 |
| DG364 | Hardware prepared for DG3-6300 Lg. Format IC cores, supplied with temporary keyed construction cores | See CK-2 |
| DX | Deadbolt Monitoring (not available with 50, 74) | \$182.00 |
| LC | Less Cylinder | -\$89.00/cyl. |
| LB | Extra large thumbturn | \$16.00 |
| LX | Latchbolt Monitor - available with all non-deadbolt functions; not available with DX option | \$185.00 |
| OBS | Open Back Strike | \$73.00 |
| RX | Request to Exit | \$190.00 |
| SC▲† | Schlage "C" Keyway cylinder, (Number 41 Cylinder Only, 0 bitted) | No addition |
| SE▲† | Schlage "E" Keyway cylinder, (Number 41 Cylinder Only, 0 bitted) | No addition |
| SG | MicroShield® - an antimicrobial powder coat finish (Not available with RAS lever) | \$67.00 |
| T1 | Decorative thumbturn; backplate matches rose design chosen | No Addition |
| T2 | Decorative square thumbturn; backplate matches rose design chosen | No Addition |
| T3 | Decorative cylinder thumbturn; backplate matches rose design chosen | No Addition |
| WBS | Wrought Box Strike | No addition |

NOTES: ▲ Options not avail. with a standard 50 function lockout cylinder. † Not avail. with 60, 63, 64 options

| | | |
|-----|--|---------|
| CPC | Clear Powder Coat over 26D/32D - 8205 x CRREM x RH x 32D x CPC All orders will continue to be handled as a "special" when CPC is ordered. | \$62.00 |
|-----|--|---------|

ASSA ABLOY

8200 STUDIO COLLECTION - GRAMERCY SERIES

USA & Canada Prices Effective June 3, 2019

Rose Design:

CO (2-3/4")
CR (2-3/16")
LN (2")
O (2-3/4")
TO (2-3/4")
TR (2-3/16")
E2 (2-11/16")
E3 (2-1/16")
E4 (3-1/3")

Lever Design:

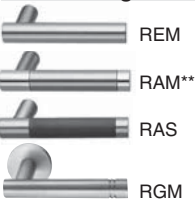

How to order Gramercy Series Levers:

Option: **63** x Function: **8204** x Rose: **LN** x Lever: **RAS** x Finish: **29BK29** x Hand: **RH**
See below for available finishes:

Lever Design Available Finishes

REM-RGM 2930 or 3030
RAM 2930*
RAS 29BK29, 30BK30

*Two-tone - grip of lever is 32D, balance of lever is 32. Rose/escutcheon and lock finish will be 32.
See catalog for finish description.

**RAM is not available in 10BE/BSP/WSP finish.

| Function – Single Cylinder | | Finish – 10BE/BSP/WSP/629/630 |
|---|------------------------------------|-------------------------------|
| 8204 | Storeroom or Closet | |
| 8205 | Office or Entry | \$1,113.00 |
| 8237 | Classroom | |
| 8255 | Office or Entry | |
| 8206 | Storeroom or Service | |
| 8231 | Utility | |
| 8236 | Closet | |
| 8256 | Office or Inner Entry | \$1,135.00 |
| 8257, 8258, 8267 | Institutional Privacy | |
| 8289 | Holdback | |
| 8291 | All Purpose Holdback | |
| Single Cylinder With Deadbolt | | |
| 8224 | Room Door | |
| 8225 | Dormitory or Exit | |
| 8227 | Closet or Storeroom | |
| 8228, 8230 | Dummy Trim Deadlock | |
| 8235 | Storeroom | \$1,161.00 |
| 8243 | Apartment Corridor | |
| 8245 | Dormitory or Exit | |
| 8247 | Front Door or Apartment Corridor | |
| 8251 | Storeroom Deadbolt | |
| 8250 | Hotel Guest Lock | \$1,198.00 |
| Double Cylinder No Deadbolt | | |
| 8216 | Apartment or Exit or Public Toilet | |
| 8217 | Asylum or Institutional | |
| 8238 | Classroom Security Intruder | \$1,208.00 |
| 8259 | School Security | |
| 8290 | Classroom Security Holdback | |
| 8292 | All Purpose Holdback | |
| Double Cylinder With Deadbolt | | |
| 8226 | Store Door | |
| 8229 | Dummy Trim Deadlock | |
| 8239, 8240 | Classroom Security Intruder | |
| 8241 | Classroom Security | \$1,230.00 |
| 8246 | Dormitory or Exit | |
| 8248 | Store Door | |
| 8249 | Security | |
| 8252 | Institutional | |
| Electro Mechanical Single Cylinder – Specify 12V or 24V | | |
| 8270-12V / 8270-24V | Fail Safe | \$1,309.00 |
| 8271-12V / 8271-24V | Fail Secure | |
| Electro Mechanical Double Cylinder – Specify 12V or 24V | | |
| 8272-12V / 8272-24V | Fail Safe | \$1,366.00 |
| 8273-12V / 8273-24V | Fail Secure | |
| Non Keyed | | |
| 8213 | Communication or Exit | \$960.00 |
| 8215 | Passage or Closet | |
| 8265 | Privacy Bedroom or Bath (Latch) | \$1,060.00 |
| 8266, 8268 | Privacy Bedroom or Bath (Deadbolt) | \$1,094.00 |
| 8293* | Single Dummy Trim | \$397.00 |
| 8294 | Double Dummy Trim | \$790.00 |
| 8295 | Single Dummy Trim w/Lockbody | \$487.00 |
| 8296 | Double Dummy Trim w/Lockbody | \$880.00 |
| 8297 | Double Dummy w/Active Trim | \$960.00 |

ML-60 MORTISE LOCKS

SARGENT®

ASSA ABLOY

OPTIONS

USA & Canada Prices Effective June 3, 2019

| Options | Description | Price |
|----------|---|-----------------------------------|
| 1▲ | 8200 Line with 1-1/16" wide front for 1-3/8" doors. | \$58.00 |
| 3 | Stainless steel hub (not available with 8289, 8291 & 8292 functions) | \$63.00 |
| 10▲ | SARGENT Signature Key System | \$58.00 / cyl. |
| 11†▲ | SARGENT XC Key System (not available with 10, 22, SC, SE options) | No addition |
| 1160 | SARGENT XC Large Format Interchangeable Plastic Disposable Construction Core | No addition |
| 1163 | SARGENT XC Large Format Interchangeable Core Cylinder - Includes masterkeying charges | \$77.00 |
| 1164 | SARGENT XC Large Format Interchangeable Construction Core Cylinder | \$77.00 |
| 1170 | Small Format interchangeable disposable construction core - to accept 7 Pin XC permanent core | No addition |
| 11727P | Small Format interchangeable keyed construction core - to accept 7 Pin XC permanent core | \$69.00 |
| 11737P | Small Format interchangeable core - to accept 7 pin XC permanent core | \$69.00 /cyl. |
| 21▲† | SARGENT Construction Key System (lost ball) Standard on all new systems established since 5/1/96 | \$16.00 / cyl. |
| 22▲† | SARGENT Construction Key System (split key) To be used on pre-established split key systems only | \$32.00 / cyl. |
| 23 | Locksets with flat 4 7/8" ANSI strike | No addition |
| 31 | Thick Doors - Extended Lip Required - Specify Length C to E | |
| | - Cylinders - IMPORTANT- See catalog 7800/8200 option page for cylinder limitations | |
| | - Below charges DO NOT include additional charges for special cylinder requirements | |
| | Doors up to 2-1/2" thick - lock centered | No addition |
| | Doors 2-5/8" to 6" thick OR doors 1-3/4" thick w/max 1" paneling one side. | |
| | For example: Specify 1-3/4" door with panel (Side) on inside or outside | |
| | Non Keyed function \$50.00 Keyed function \$100.00 | |
| 60 | SARGENT Large Format Interchangeable Plastic Disposable Construction Core | No addition |
| 63 | SARGENT Large Format Interchangeable core cylinder, includes master keying charges | \$77.00 / cyl. |
| 64 | SARGENT Large Format Interchangeable Construction Core Cylinder | \$77.00 |
| 6573▲† | Small Format 6-Pin Uncombined Core (Refer to CK-12) | \$59.00 / cyl. |
| 65737P▲† | Small Format 7-Pin Uncombined Core (Refer to CK-12) | \$59.00 / cyl. |
| 68 | 8200 Line furnished with lever handle outside x knob inside (Excludes SLD Detention Knob) | Defaults to 8200 Lever Lock Price |
| 69 | 8200 Line furnished with lever handle inside x knob outside (Excludes SLD Detention Knob) | Defaults to 8200 Lever Lock Price |
| 70▲† | Small Format Interchangeable disposable plastic construction core | No addition |
| 72▲† | Small Format Interchangeable 6-pin construction core (7-pin with 11 option) | \$69.00 |
| 73▲† | Small Format interchangeable core 6-pin Includes MK and GMK keying charges | \$69.00 / cyl |
| 737P▲† | Small Format interchangeable core 7-pin (refer to CK-12 for available keyways) Includes MK and GMK keying charges | \$69.00 / cyl |
| 81▲† | Cylinder to accept Keso (83) and Keso F1 (F183) removable core – no core provided | No addition |
| F182† | SARGENT Keso Security Cylinder – patented – new key systems | \$84.00 / cyl. |
| F183▲† | SARGENT Keso Security Removable Core Cylinder – patented – new key systems | \$120.00 / cyl. |
| 82† | SARGENT Keso Security Cylinder (For existing systems only) | \$84.00 / cyl. |
| 83▲† | SARGENT Keso Security Removable Core Cylinder (For existing systems only) | \$120.00 / cyl. |
| 84▲† | SARGENT Keso Security Removable Construction Core Cylinder | See CK-18 |
| 85 | Tactile Warning - Abrasive coating on inside lever | \$45.00 |
| 86 | Tactile Warning - Abrasive coating on outside lever | \$45.00 |
| 87 | Tactile Warning - Abrasive coating on both levers | \$90.00 |
| AV | Anti Vandal Pull Trim (available in 32D finish), (Not available with 8270, 8271, 8272, 8273 functions) | \$212.00 |
| BR | SARGENT Bump Resistant Cylinders (N/A w/10, 22, 30, 60, 63, 64, 70, 72, 73, 737P, KESO, SC, & SE options) | \$23.00 /cyl. |
| DG1 | Patented Degree DG1 Key System | No Addition |
| DG160 | Hardware prepared for DG1-6300 Lg. Format IC cores, supplied with temporary plastic construction cores | No addition |
| DG163 | Patented Degree DG1 Large Format Interchangeable Core Cylinder - Includes master keying charges | \$77.00 |
| DG164 | Hardware prepared for DG1-6300 Lg. Format IC cores, supplied with temporary keyed construction cores | \$77.00 |
| DG2 | Patented Degree DG2 Key System incorporating a locking sidebar | \$58.00/cyl. |
| DG260 | Hardware prepared for DG2-6300 Lg. Format IC cores, supplied with temporary plastic construction cores | No addition |
| DG263 | Patented Degree DG2 Large Format Interchangeable Core Cylinder - Includes master keying charges | \$135.00 |
| DG264 | Hardware prepared for DG2-6300 Lg. Format IC cores, supplied with temporary keyed construction cores | \$77.00 |
| DG3 | Patented Degree DG3 Key System incorporating a locking sidebar and UL437 listed | \$82.00/cyl. |
| DG360 | Hardware prepared for DG3-6300 Lg. Format IC cores, supplied with temporary plastic construction cores | No addition |
| DG363 | Patented Degree DG3 Large Format Interchangeable Core Cylinder - Includes master keying charges | \$159.00 |
| DG364 | Hardware prepared for DG3-6300 Lg. Format IC cores, supplied with temporary keyed construction cores | \$77.00 |
| IDP | Integrated Door Position Switch | \$100.00 |
| LB | Extra large thumbturn | \$16.00 |
| LC | Less Cylinder | -\$89.00/cyl. |
| OBS | Open Back Strike | \$73.00 |
| PHR | Deadbolt Privacy Function (available w/deadbolt function only) | \$100.00 |
| R01 | Mercury and Lenel compatible 1KΩ/2KΩ resistance supervision | \$100.00 |
| R03 | Software House compatible 1KΩ/2KΩ resistance supervision | \$100.00 |
| R04 | AMAG compatible 4-state supervision | \$100.00 |
| SC▲† | Schlage "C" Keyway cylinder, (Number 41 Cylinder Only, 0 bitted) | No addition |
| SE▲† | Schlage "E" Keyway cylinder, (Number 41 Cylinder Only, 0 bitted) | No addition |
| SG | MicroShield® – an antimicrobial powder coat finish | \$67.00 |
| WBS | Wrought Box Strike | No addition |

NOTES: ▲ Options not avail. with a standard 50 function lockout cylinder. † Not avail. with 60, 63, 64 options

| | | |
|-----|--|---------|
| CPC | Clear Powder Coat over 26D/32D – NAC-82280-24V x CEMD x RH x 32D x CPC | \$62.00 |
| | All orders will continue to be handled as a "special" when CPC is ordered. | |

ASSA ABLOY, the global leader
in door opening solutions

Copyright © 2002-2019 Sargent Manufacturing Company, an ASSA ABLOY Group company. All rights reserved.
Reproduction in whole or in part without the express written permission of Sargent Manufacturing Company is prohibited.
Contact us at: 800-727-5477 or visit www.sargentlock.com. In Canada contact us at: 800-461-3007 or visit www.assaabloydss.ca

Rose Design:

CO (2-3/4")
CR (2-3/16")
LN (2")
O (2-3/4")
TO (2-3/4")
TR (2-3/16")
E2 (2-11/16")
E3 (2-1/16")
E4 (3-1/3")

Lever Design:

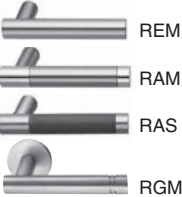

How to order Gramercy Series Levers:

Option: **NAC** x Function: **82271-24V** x Rose: **LN** x Lever: **RAS** x Finish: **29BK29** x Hand: **RH**

See below for available finishes:

Lever Design Available Finishes

| Lever Design | Available Finishes |
|--------------|--------------------|
| REM-RGM | 2930 or 3030 |
| RAM | 2930* |
| RAS | 29BK29, 30BK30 |

*Two-tone - grip of lever is 32D, balance of lever is 32. Rose/escutcheon and lock finish will be 32. See catalog for finish description.

**RAM is not available in 10BE/BSP/WSP finish.

| NAC 8200 Electrified Mortise Locks with High Security Monitoring | | | | 10BE/BSP/WSP/ 629/630 |
|--|----------------|------------------------|--------------------------------------|--------------------------|
| Option | Function | Trim - Proximity Entry | Description | |
| NAC | 82270-12V/-24V | Rose x Lever Design | Fail Safe w/Cylinder Override | \$1,484.00 |
| NAC | 82271-12V/-24V | Rose x Lever Design | Fail Secure w/Cylinder Override | |
| NAC | 82280-12V/-24V | Rose x Lever Design | Fail Safe w/Deadbolt w/Cyl.Override | \$1,559.00 |
| NAC | 82281-12V/-24V | Rose x Lever Design | Fail Secure w/D.bolt w/Cyl.Override | |
| NAC | 82274-12V/-24V | Rose x Lever Design | Fail Safe - No Cylinder | \$1,429.00 |
| NAC | 82275-12V/-24V | Rose x Lever Design | Fail Secure - No Cylinder | |
| NAC | 82284-12V/-24V | Rose x Lever Design | Fail Safe w/Deadbolt - No Cylinder | \$1,504.00 |
| NAC | 82285-12V/-24V | Rose x Lever Design | Fail Secure w/Deadbolt - No Cylinder | |

Note: Consult catalog for ordering information.

Specify hand and voltage (12v or 24v) when ordering

ML-62 MORTISE LOCKS

SARGENT®

ASSA ABLOY

OPTIONS

USA & Canada Prices Effective June 3, 2019

| Options | Description | Price |
|----------|--|---|
| 1▲ | 8200 Line with 1-1/16" wide front for 1-3/8" doors. | \$58.00 |
| 3 | Stainless steel hub (not available with 8289, 8291 & 8292 functions) | \$63.00 |
| 10▲ | SARGENT Signature Key System | \$58.00 / cyl. |
| 11†▲ | SARGENT XC Key System (not available with 10, 22, SC, SE options) | No addition |
| 1160 | SARGENT XC Large Format Interchangeable Plastic Disposable Construction Core | No addition |
| 1163 | SARGENT XC Large Format Interchangeable Core Cylinder - Includes masterkeying charges | \$77.00 |
| 1164 | SARGENT XC Large Format Interchangeable Construction Core Cylinder | \$77.00 |
| 1170 | Small Format interchangeable disposable construction core - to accept 7 Pin XC permanent core | No addition |
| 11727P | Small Format interchangeable keyed construction core - to accept 7 Pin XC permanent core | \$69.00 |
| 11737P | Small Format interchangeable core - to accept 7 pin XC permanent core | \$69.00 /cyl. |
| 21▲† | SARGENT Construction Key System (lost ball) Standard on all new systems established since 5/1/96 | \$16.00 / cyl. |
| 22▲† | SARGENT Construction Key System (split key) To be used on pre-established split key systems only | \$32.00 / cyl. |
| 23 | Locksets with flat 4 7/8" ANSI strike | No addition |
| 31 | Thick Doors - Extended Lip Required - Specify Length C to E - Cylinders - IMPORTANT- See catalog 7800/8200 option page for cylinder limitations - Below charges DO NOT include additional charges for special cylinder requirements Doors up to 2-1/2" thick - lock centered Doors 2-5/8" to 6" thick OR doors 1-3/4" thick w/max 1" paneling one side. For example: Specify 1-3/4" door with panel (Side) on inside or outside | No addition Non Keyed function \$50.00 Keyed function \$100.00 |
| 49 | Visual Status Indicator - Available with 30, 36, 37 function - Rose Trims CR, E, L, LN, O, TR - Available with 26, 29, 38, 39 40, 41 functions - Rose Trim 8200 LN | \$92.00 |
| 49 | Occupancy Indicator with emergency Release - Available with 65, 66, 68 functions; Rose Trims 7800 CR, E, L, LN, O, TR | \$92.00 |
| 50 | Secured Indicator Rose- doors 1-5/8" to 2-1/4" thick- Avail.w/24,25,26,28,29,30,36,37,38,39,40,41,43,45,50,51,52,57,58,67 functions | \$62.00 |
| 60 | SARGENT Large Format Interchangeable Plastic Disposable Construction Core | No addition |
| 63 | SARGENT Large Format Interchangeable core cylinder, includes master keying charges | \$77.00 / cyl. |
| 64 | SARGENT Large Format Interchangeable Construction Core Cylinder | \$77.00 |
| 6573▲† | Small Format 6-Pin Uncombined Core (Refer to CK-12) | \$59.00 / cyl. |
| 65737P▲† | Small Format 7-Pin Uncombined Core (Refer to CK-12) | \$59.00 / cyl. |
| 68 | 8200 Line furnished with lever handle outside x knob inside (Excludes SLD Detention Knob) | Defaults to 8200 Lever Lock Price |
| 69 | 8200 Line furnished with lever handle inside x knob outside (Excludes SLD Detention Knob) | Defaults to 8200 Lever Lock Price |
| 70▲† | Small Format Interchangeable disposable plastic construction core | No addition |
| 72▲† | Small Format Interchangeable 6-pin construction core (7-pin with 11 option) | \$69.00 |
| 73▲† | Small Format interchangeable core 6-pin Includes MK and GMK keying charges | \$69.00 / cyl |
| 737P▲† | Small Format interchangeable core 7-pin (refer to CK-12 for available keyways) Includes MK and GMK keying charges | \$69.00 / cyl |
| 74 | Lock case wrapped in lead - handing required (roses not available) | \$272.00 |
| 81▲† | Cylinder to accept Keso (83) and Keso F1 (F183) removable core - no core provided | No addition |
| F182† | SARGENT Keso Security Cylinder - patented - new key systems | \$84.00 / cyl. |
| F183▲† | SARGENT Keso Security Removable Core Cylinder - patented - new key systems | \$120.00 / cyl. |
| 82† | SARGENT Keso Security Cylinder (For existing systems only) | \$84.00 / cyl. |
| 83▲† | SARGENT Keso Security Removable Core Cylinder (For existing systems only) | \$120.00 / cyl. |
| 84▲† | SARGENT Keso Security Removable Construction Core Cylinder | See CK-18 |
| AV | Anti Vandal Pull Trim (available in 32D finish), (Not available with 8270, 8271, 8272, 8273 functions) | \$212.00 |
| BR | SARGENT Bump Resistant Cylinders (N/A w/10, 22, 30, 60, 63, 64, 70, 72, 73, 737P, KESO, SC, & SE options) | \$23.00 /cyl. |
| DG1 | Patented Degree DG1 Key System | No Addition |
| DG160 | Hardware prepared for DG1-6300 Lg. Format IC cores, supplied with temporary plastic construction cores | No addition |
| DG163 | Patented Degree DG1 Large Format Interchangeable Core Cylinder - Includes master keying charges | \$77.00 |
| DG164 | Hardware prepared for DG1-6300 Lg. Format IC cores, supplied with temporary keyed construction cores | \$77.00 |
| DG2 | Patented Degree DG2 Key System incorporating a locking sidebar | \$58.00/cyl. |
| DG260 | Hardware prepared for DG2-6300 Lg. Format IC cores, supplied with temporary plastic construction cores | No addition |
| DG263 | Patented Degree DG2 Large Format Interchangeable Core Cylinder - Includes master keying charges | \$135.00 |
| DG264 | Hardware prepared for DG2-6300 Lg. Format IC cores, supplied with temporary keyed construction cores | \$77.00 |
| DG3 | Patented Degree DG3 Key System incorporating a locking sidebar and UL437 listed | \$82.00/cyl. |
| DG360 | Hardware prepared for DG3-6300 Lg. Format IC cores, supplied with temporary plastic construction cores | No addition |
| DG363 | Patented Degree DG3 Large Format Interchangeable Core Cylinder - Includes master keying charges | \$159.00 |
| DG364 | Hardware prepared for DG3-6300 Lg. Format IC cores, supplied with temporary keyed construction cores | \$77.00 |
| DX | Deadbolt Monitoring (not available with 50, 74) | \$182.00 |
| LC | Less Cylinder | -\$89.00/cyl. |
| LB | Extra large thumbturn | \$16.00 |
| LX | Latchbolt Monitor - available with all non-deadbolt functions; not available with DX option | \$185.00 |
| OBS | Open Back Strike | \$73.00 |
| RX | Request to Exit | \$190.00 |
| SC▲† | Schlage "C" Keyway cylinder, (Number 41 Cylinder Only, 0 bitted) | No addition |
| SE▲† | Schlage "E" Keyway cylinder, (Number 41 Cylinder Only, 0 bitted) | No addition |
| SG | MicroShiel™ - an antimicrobial powder coat finish (Not available with RAL levers) | \$67.00 |
| T1 | Decorative thumbturn; backplate matches rose design chosen | No Addition |
| T2 | Decorative square thumbturn; backplate matches rose design chosen | No Addition |
| T3 | Decorative cylinder thumbturn; backplate matches rose design chosen | No Addition |
| WBS | Wrought Box Strike | No addition |

NOTES: ▲ Options not avail. with a standard 50 function lockout cylinder. † Not avail. with 60, 63, 64 options

| | | |
|-----|--|---------|
| CPC | Clear Powder Coat over 26D/32D - 8205 x CRRCM x RH x 32D x CPC All orders will continue to be handled as a "special" when CPC is ordered. | \$62.00 |
|-----|--|---------|

Rose Design:

CO (2-3/4")
CR (2-3/16")
LN (2")
O (2-3/4")
TO (2-3/4")
TR (2-3/16")
E2 (2-11/16")
E3 (2-1/16")
E4 (3-1/3")

Lever Design:

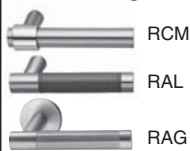

How to order Gramercy Series Levers:

Option: 1Q x Function: 8204 x Rose: 1Q x Lever: RAL x Finish: 29BK29 x Hand: RH
See below for available finishes:

Lever Design Available Finishes

RCM 2929, 3030, or 2930*
RAL 29BK29, 29BN29, 30BK30, or 30BN30
RAG 2929 or 3030

*Two-tone - grip of lever is 32D, balance of lever is 32. Rose/escutcheon and lock finish will be 32. See catalog for finish description.

| Function – Single Cylinder | | Finish – 10BE/BSP/WSP/629/630 |
|---|------------------------------------|-------------------------------|
| 8204 | Storeroom or Closet | |
| 8205 | Office or Entry | \$1,193.00 |
| 8237 | Classroom | |
| 8255 | Office or Entry | |
| 8206 | Storeroom or Service | |
| 8231 | Utility | |
| 8236 | Closet | |
| 8256 | Office or Inner Entry | \$1,216.00 |
| 8257, 8258, 8267 | Institutional Privacy | |
| 8289 | Holdback | |
| 8291 | All Purpose Holdback | |
| Single Cylinder With Deadbolt | | |
| 8224 | Room Door | |
| 8225 | Dormitory or Exit | |
| 8227 | Closet or Storeroom | |
| 8228, 8230 | Dummy Trim Deadlock | |
| 8235 | Storeroom | \$1,244.00 |
| 8243 | Apartment Corridor | |
| 8245 | Dormitory or Exit | |
| 8247 | Front Door or Apartment Corridor | |
| 8251 | Storeroom Deadbolt | |
| 8250 | Hotel Guest Lock | \$1,279.00 |
| Double Cylinder No Deadbolt | | |
| 8216 | Apartment or Exit or Public Toilet | |
| 8217 | Asylum or Institutional | |
| 8238 | Classroom Security Intruder | \$1,289.00 |
| 8259 | School Security | |
| 8290 | Classroom Security Holdback | |
| 8292 | All Purpose Holdback | |
| Double Cylinder With Deadbolt | | |
| 8226 | Store Door | |
| 8229 | Dummy Trim Deadlock | |
| 8239, 8240 | Classroom Security Intruder | |
| 8241 | Classroom Security | \$1,309.00 |
| 8246 | Dormitory or Exit | |
| 8248 | Store Door | |
| 8249 | Security | |
| 8252 | Institutional | |
| Electro Mechanical Single Cylinder – Specify 12V or 24V | | |
| 8270-12V / 8270-24V | Fail Safe | \$1,389.00 |
| 8271-12V / 8271-24V | Fail Secure | |
| Electro Mechanical Double Cylinder – Specify 12V or 24V | | |
| 8272-12V / 8272-24V | Fail Safe | \$1,446.00 |
| 8273-12V / 8273-24V | Fail Secure | |
| Non Keyed | | |
| 8213 | Communication or Exit | \$1,040.00 |
| 8215 | Passage or Closet | |
| 8265 | Privacy Bedroom or Bath (Latch) | \$1,138.00 |
| 8266, 8268 | Privacy Bedroom or Bath (Deadbolt) | \$1,176.00 |
| 8293* | Single Dummy Trim | \$477.00 |
| 8294 | Double Dummy Trim | \$873.00 |
| 8295 | Single Dummy Trim w/Lockbody | \$567.00 |
| 8296 | Double Dummy Trim w/Lockbody | \$961.00 |
| 8297 | Double Dummy w/Active Trim | \$1,040.00 |

ML-64 MORTISE LOCKS

SARGENT®

ASSA ABLOY

OPTIONS

USA & Canada Prices Effective June 3, 2019

| Options | Description | Price |
|----------|---|-----------------------------------|
| 1▲ | 8200 Line with 1-1/16" wide front for 1-3/8" doors. | \$58.00 |
| 3 | Stainless steel hub (not available with 8289, 8291 & 8292 functions) | \$63.00 |
| 10▲ | SARGENT Signature Key System | \$58.00 / cyl. |
| 11†▲ | SARGENT XC Key System (not available with 10, 22, SC, SE options) | No addition |
| 1160 | SARGENT XC Large Format Interchangeable Plastic Disposable Construction Core | No addition |
| 1163 | SARGENT XC Large Format Interchangeable Core Cylinder - Includes masterkeying charges | \$77.00 |
| 1164 | SARGENT XC Large Format Interchangeable Construction Core Cylinder | \$77.00 |
| 1170 | Small Format interchangeable disposable construction core - to accept 7 Pin XC permanent core | No addition |
| 11727P | Small Format interchangeable keyed construction core - to accept 7 Pin XC permanent core | \$69.00 |
| 11737P | Small Format interchangeable core - to accept 7 pin XC permanent core | \$69.00 /cyl. |
| 21▲† | SARGENT Construction Key System (lost ball) Standard on all new systems established since 5/1/96 | \$16.00 / cyl. |
| 22▲† | SARGENT Construction Key System (split key) To be used on pre-established split key systems only | \$32.00 / cyl. |
| 23 | Locksets with flat 4 7/8" ANSI strike | No addition |
| 31 | Thick Doors - Extended Lip Required - Specify Length C to E | |
| | - Cylinders - IMPORTANT- See catalog 7800/8200 option page for cylinder limitations | |
| | - Below charges DO NOT include additional charges for special cylinder requirements | |
| | Doors up to 2-1/2" thick - lock centered | No addition |
| | Doors 2-5/8" to 6" thick OR doors 1-3/4" thick w/max 1" paneling one side. | |
| | For example: Specify 1-3/4" door with panel (Side) on inside or outside | |
| | Non Keyed function \$50.00 Keyed function \$100.00 | |
| 60 | SARGENT Large Format Interchangeable Plastic Disposable Construction Core | No addition |
| 63 | SARGENT Large Format Interchangeable core cylinder, includes master keying charges | \$77.00 / cyl. |
| 64 | SARGENT Large Format Interchangeable Construction Core Cylinder | \$77.00 |
| 6573▲† | Small Format 6-Pin Uncombined Core (Refer to CK-12) | \$59.00 / cyl. |
| 65737P▲† | Small Format 7-Pin Uncombined Core (Refer to CK-12) | \$59.00 / cyl. |
| 68 | 8200 Line furnished with lever handle outside x knob inside (Excludes SLD Detention Knob) | Defaults to 8200 Lever Lock Price |
| 69 | 8200 Line furnished with lever handle inside x knob outside (Excludes SLD Detention Knob) | Defaults to 8200 Lever Lock Price |
| 70▲† | Small Format Interchangeable disposable plastic construction core | No addition |
| 72▲† | Small Format Interchangeable 6-pin construction core (7-pin with 11 option) | \$69.00 |
| 73▲† | Small Format interchangeable core 6-pin Includes MK and GMK keying charges | \$69.00 / cyl |
| 737P▲† | Small Format interchangeable core 7-pin (refer to CK-12 for available keyways) Includes MK and GMK keying charges | \$69.00 / cyl |
| 81▲† | Cylinder to accept Keso (83) and Keso F1 (F183) removable core – no core provided | No addition |
| F182† | SARGENT Keso Security Cylinder – patented – new key systems | \$84.00 / cyl. |
| F183▲† | SARGENT Keso Security Removable Core Cylinder – patented – new key systems | \$120.00 / cyl. |
| 82† | SARGENT Keso Security Cylinder (For existing systems only) | \$84.00 / cyl. |
| 83▲† | SARGENT Keso Security Removable Core Cylinder (For existing systems only) | \$120.00 / cyl. |
| 84▲† | SARGENT Keso Security Removable Construction Core Cylinder | See CK-18 |
| 85 | Tactile Warning - Abrasive coating on inside lever | \$45.00 |
| 86 | Tactile Warning - Abrasive coating on outside lever | \$45.00 |
| 87 | Tactile Warning - Abrasive coating on both levers | \$90.00 |
| AV | Anti Vandal Pull Trim (available in 32D finish), (Not available with 8270, 8271, 8272, 8273 functions) | \$212.00 |
| BR | SARGENT Bump Resistant Cylinders (N/A w/10, 22, 30, 60, 63, 64, 70, 72, 73, 737P, KESO, SC, & SE options) | \$23.00 /cyl. |
| DG1 | Patented Degree DG1 Key System | No Addition |
| DG160 | Hardware prepared for DG1-6300 Lg. Format IC cores, supplied with temporary plastic construction cores | No addition |
| DG163 | Patented Degree DG1 Large Format Interchangeable Core Cylinder - Includes master keying charges | \$77.00 |
| DG164 | Hardware prepared for DG1-6300 Lg. Format IC cores, supplied with temporary keyed construction cores | \$77.00 |
| DG2 | Patented Degree DG2 Key System incorporating a locking sidebar | \$58.00/cyl. |
| DG260 | Hardware prepared for DG2-6300 Lg. Format IC cores, supplied with temporary plastic construction cores | No addition |
| DG263 | Patented Degree DG2 Large Format Interchangeable Core Cylinder - Includes master keying charges | \$135.00 |
| DG264 | Hardware prepared for DG2-6300 Lg. Format IC cores, supplied with temporary keyed construction cores | \$77.00 |
| DG3 | Patented Degree DG3 Key System incorporating a locking sidebar and UL437 listed | \$82.00/cyl. |
| DG360 | Hardware prepared for DG3-6300 Lg. Format IC cores, supplied with temporary plastic construction cores | No addition |
| DG363 | Patented Degree DG3 Large Format Interchangeable Core Cylinder - Includes master keying charges | \$159.00 |
| DG364 | Hardware prepared for DG3-6300 Lg. Format IC cores, supplied with temporary keyed construction cores | \$77.00 |
| IDP | Integrated Door Position Switch | \$100.00 |
| LB | Extra large thumbturn | \$16.00 |
| LC | Less Cylinder | -\$89.00/cyl. |
| OBS | Open Back Strike | \$73.00 |
| PHR | Deadbolt Privacy Function (available w/deadbolt function only) | \$100.00 |
| R01 | Mercury and Lenel compatible 1KΩ/2KΩ resistance supervision | \$100.00 |
| R03 | Software House compatible 1KΩ/2KΩ resistance supervision | \$100.00 |
| R04 | AMAG compatible 4-state supervision | \$100.00 |
| SC▲† | Schlage "C" Keyway cylinder, (Number 41 Cylinder Only, 0 bitted) | No addition |
| SE▲† | Schlage "E" Keyway cylinder, (Number 41 Cylinder Only, 0 bitted) | No addition |
| SG | MicroShield® – an antimicrobial powder coat finish | \$67.00 |
| WBS | Wrought Box Strike | No addition |

NOTES: ▲ Options not avail. with a standard 50 function lockout cylinder. † Not avail. with 60, 63, 64 options

| | | |
|-----|--|---------|
| CPC | Clear Powder Coat over 26D/32D – NAC-82280-24V x CEMD x RH x 32D x CPC | \$62.00 |
| | All orders will continue to be handled as a "special" when CPC is ordered. | |

ASSA ABLOY, the global leader
in door opening solutions

Copyright © 2002-2019 Sargent Manufacturing Company, an ASSA ABLOY Group company. All rights reserved.
Reproduction in whole or in part without the express written permission of Sargent Manufacturing Company is prohibited.
Contact us at: 800-727-5477 or visit www.sargentlock.com. In Canada contact us at: 800-461-3007 or visit www.assaabloydss.ca

USA & Canada Prices Effective June 3, 2019

Rose Design:

CO (2-3/4")
CR (2-3/16")
LN (2")
O (2-3/4")
TO (2-3/4")
TR (2-3/16")
E2 (2-11/16")
E3 (2-1/16")
E4 (3-1/3")

Lever Design:

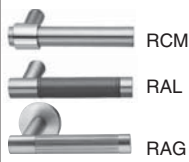

How to order Gramercy Series Levers:

Option: **NAC** x Function: **82280-24V** x Rose: **TO** x Lever: **RAL** x Finish: **29BK29** x Hand: **RH**
See below for available finishes:

Lever Design Available Finishes

RCM 2929, 3030, or 2930*
RAL 29BK29, 29BN29, 30BK30, or 30BN30
RAG 2929 or 3030

*Two-tone - grip of lever is 32D, balance of lever is 32. Rose/escutcheon and lock finish will be 32. See catalog for finish description.

| NAC 8200 Electrified Mortise Locks with High Security Monitoring | | | | 10BE/BSP/WSP/ 629/630 |
|--|----------------|------------------------|--------------------------------------|--------------------------|
| Option | Function | Trim - Proximity Entry | Description | |
| NAC | 82270-12V/-24V | Rose x Lever Design | Fail Safe w/Cylinder Override | \$1,564.00 |
| NAC | 82271-12V/-24V | Rose x Lever Design | Fail Secure w/Cylinder Override | |
| NAC | 82280-12V/-24V | Rose x Lever Design | Fail Safe w/Deadbolt w/Cyl.Override | \$1,639.00 |
| NAC | 82281-12V/-24V | Rose x Lever Design | Fail Secure w/D.bolt w/Cyl.Override | |
| NAC | 82274-12V/-24V | Rose x Lever Design | Fail Safe - No Cylinder | \$1,509.00 |
| NAC | 82275-12V/-24V | Rose x Lever Design | Fail Secure - No Cylinder | |
| NAC | 82284-12V/-24V | Rose x Lever Design | Fail Safe w/Deadbolt - No Cylinder | \$1,584.00 |
| NAC | 82285-12V/-24V | Rose x Lever Design | Fail Secure w/Deadbolt - No Cylinder | |

Note: Consult catalog for ordering information.

Specify hand and voltage (12v or 24v) when ordering

ML-66 MORTISE LOCKS

SARGENT®

ASSA ABLOY

OPTIONS

USA & Canada Prices Effective June 3, 2019

| Options | Description | Price |
|---|--|-----------------------------------|
| 1▲ | 8200 Line with 1-1/16" wide front for 1-3/8" doors. | \$58.00 |
| 3 | Stainless steel hub (not available with 8289, 8291 & 8292 functions) | \$63.00 |
| 10▲ | SARGENT Signature Key System | \$58.00 / cyl. |
| 11†▲ | SARGENT XC Key System (not available with 10, 22, SC, SE options) | No addition |
| 1160 | SARGENT XC Large Format Interchangeable Plastic Disposable Construction Core | No addition |
| 1163 | SARGENT XC Large Format Interchangeable Core Cylinder - Includes masterkeying charges | \$77.00 |
| 1164 | SARGENT XC Large Format Interchangeable Construction Core Cylinder | \$77.00 |
| 1170 | Small Format interchangeable disposable construction core - to accept 7 Pin XC permanent core | No addition |
| 11727P | Small Format interchangeable keyed construction core - to accept 7 Pin XC permanent core | \$69.00 |
| 11737P | Small Format interchangeable core - to accept 7 pin XC permanent core | \$69.00 / cyl. |
| 21▲† | SARGENT Construction Key System (lost ball) Standard on all new systems established since 5/1/96 | \$16.00 / cyl. |
| 22▲† | SARGENT Construction Key System (split key) To be used on pre-established split key systems only | \$32.00 / cyl. |
| 23 | Locksets with flat 4 7/8" ANSI strike | No addition |
| 31 | Thick Doors - Extended Lip Required - Specify Length C to E - Cylinders - IMPORTANT- See catalog 7800/8200 option page for cylinder limitations - Below charges DO NOT include additional charges for special cylinder requirements Doors up to 2-1/2" thick - lock centered Doors 2-5/8" to 6" thick OR doors 1-3/4" thick w/max 1" paneling one side. For example: Specify 1-3/4" door with panel (Side) on inside or outside | No addition |
| 60 | SARGENT Large Format Interchangeable Plastic Disposable Construction Core | No addition |
| 63 | SARGENT Large Format Interchangeable core cylinder, includes master keying charges | \$77.00 / cyl. |
| 64 | SARGENT Large Format Interchangeable Construction Core Cylinder | \$77.00 |
| 6573▲† | Small Format 6-Pin Uncombined Core (Refer to CK-12) | \$59.00 / cyl. |
| 65737P▲† | Small Format 7-Pin Uncombined Core (Refer to CK-12) | \$59.00 / cyl. |
| 68 | 8200 Line furnished with lever handle outside x knob inside (Excludes SLD Detention Knob) | Defaults to 8200 Lever Lock Price |
| 69 | 8200 Line furnished with lever handle inside x knob outside (Excludes SLD Detention Knob) | Defaults to 8200 Lever Lock Price |
| 70▲† | Small Format Interchangeable disposable plastic construction core | No addition |
| 72▲† | Small Format Interchangeable 6-pin construction core (7-pin with 11 option) | \$69.00 |
| 73▲† | Small Format interchangeable core 6-pin Includes MK and GMK keying charges | \$69.00 / cyl |
| 737P▲† | Small Format interchangeable core 7-pin (refer to CK-12 for available keyways) Includes MK and GMK keying charges | \$69.00 / cyl |
| 81▲† | Cylinder to accept Keso (83) and Keso F1 (F183) removable core – no core provided | No addition |
| F182† | SARGENT Keso Security Cylinder – patented – new key systems | \$84.00 / cyl. |
| F183▲† | SARGENT Keso Security Removable Core Cylinder – patented – new key systems | \$120.00 / cyl. |
| 82† | SARGENT Keso Security Cylinder (For existing systems only) | \$84.00 / cyl. |
| 83▲† | SARGENT Keso Security Removable Core Cylinder (For existing systems only) | \$120.00 / cyl. |
| 84▲† | SARGENT Keso Security Removable Construction Core Cylinder | See CK-18 |
| AV | Anti Vandal Pull Trim (available in 32D finish), (Not available with 8270, 8271, 8272, 8273 functions) | \$212.00 |
| BR | SARGENT Bump Resistant Cylinders (N/A w/10, 22, 30, 60, 63, 64, 70, 72, 73, 737P, KESO, SC, & SE options) | \$23.00 /cyl. |
| DG1 | Patented Degree DG1 Key System | No Addition |
| DG160 | Hardware prepared for DG1-6300 Lg. Format IC cores, supplied with temporary plastic construction cores | No addition |
| DG163 | Patented Degree DG1 Large Format Interchangeable Core Cylinder - Includes master keying charges | \$77.00 |
| DG164 | Hardware prepared for DG1-6300 Lg. Format IC cores, supplied with temporary keyed construction cores | \$77.00 |
| DG2 | Patented Degree DG2 Key System incorporating a locking sidebar | \$58.00/cyl. |
| DG260 | Hardware prepared for DG2-6300 Lg. Format IC cores, supplied with temporary plastic construction cores | No addition |
| DG263 | Patented Degree DG2 Large Format Interchangeable Core Cylinder - Includes master keying charges | \$135.00 |
| DG264 | Hardware prepared for DG2-6300 Lg. Format IC cores, supplied with temporary keyed construction cores | \$77.00 |
| DG3 | Patented Degree DG3 Key System incorporating a locking sidebar and UL437 listed | \$82.00/cyl. |
| DG360 | Hardware prepared for DG3-6300 Lg. Format IC cores, supplied with temporary plastic construction cores | No addition |
| DG363 | Patented Degree DG3 Large Format Interchangeable Core Cylinder - Includes master keying charges | \$159.00 |
| DG364 | Hardware prepared for DG3-6300 Lg. Format IC cores, supplied with temporary keyed construction cores | \$77.00 |
| DX | Deadbolt Monitoring (not available with 50, 74) | \$182.00 |
| EMA* | "Lock" directional arrow engraving provided for outside LE1 escutcheon trim only | \$44.00 |
| EMB* | "Lock" directional arrow engraving provided for inside LE1 escutcheon trim only | \$44.00 |
| EMC* | "Lock" directional arrow engraving provided for both sides of LE1 escutcheon trim | \$88.00 |
| LB | Extra large thumbturn | \$13.00 |
| LC | Less Cylinder | -\$89.00/cyl. |
| LX | Latchbolt Monitor – available with all non-deadbolt functions; not available with DX option | \$185.00 |
| OBS | Open Back Strike | \$73.00 |
| RX | Request to Exit | \$190.00 |
| SC▲† | Schlage "C" Keyway cylinder, (Number 41 Cylinder Only, 0 bitted) | No addition |
| SE▲† | Schlage "E" Keyway cylinder, (Number 41 Cylinder Only, 0 bitted) | No addition |
| SG | MicroShield® – an antimicrobial powder coat finish (Not available with RAS lever) | \$67.00 |
| VNA | Status indicator provided for the outside LE1 escutcheon trim only | \$92.00 |
| VNB | Status indicator provided for the inside LE1 escutcheon trim only | \$92.00 |
| VNC | Status indicators provided for both sides of LE1 escutcheon trim | \$184.00 |
| WBS | Wrought Box Strike | No addition |
| NOTES: ▲ Options not avail. with a standard 50 function lockout cylinder. † Not avail. with 60, 63, 64 options | | |
| CPC | Clear Powder Coat over 26D/32D – 8205 x CEREM x RH x 32D x CPC All orders will continue to be handled as a "special" when CPC is ordered. | \$62.00 |

Esc. Design:

CE
TE
LE1

Lever Design:

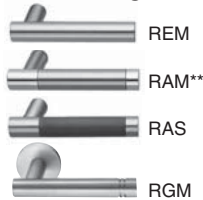

How to order Gramercy Series Levers:

Option: 10 x Function: 8204 x Esc.: CE x Lever: REM x Finish: 2930 x Hand: RH

See below for available finishes:

Lever Design Available Finishes

REM-RGM 2930 or 3030
RAM 2930*
RAS 29BK29, 30BK30

*Two-tone - grip of lever is 32D, balance of lever is 32. Rose/escutcheon and lock finish will be 32.
See catalog for finish description.

**RAM is not available in 10BE/BSP/WSP finish.

| Function – Single Cylinder | | Finish – 10BE/BSP/WSP/629/630 |
|--|------------------------------------|-------------------------------|
| 8204 | Storeroom or Closet | |
| 8205 | Office or Entry | \$1,208.00 |
| 8237 | Classroom | |
| 8255 | Office or Entry | |
| 8206 | Storeroom or Service | |
| 8231 | Utility | |
| 8236 | Closet | |
| 8256 | Office or Inner Entry | \$1,230.00 |
| 8257, 8258, 8267 | Institutional Privacy | |
| 8289 | Holdback | |
| 8291 | All Purpose Holdback | |
| Single Cylinder With Deadbolt | | |
| 8224 | Room Door | |
| 8225 | Dormitory or Exit | |
| 8227 | Closet or Storeroom | |
| 8228, 8230 | Dummy Trim Deadlock | |
| 8235 | Storeroom | \$1,257.00 |
| 8243 | Apartment Corridor | |
| 8245 | Dormitory or Exit | |
| 8247 | Front Door or Apartment Corridor | |
| 8251 | Storeroom Deadbolt | |
| 8250 | Hotel Guest Lock | \$1,288.00 |
| Double Cylinder No Deadbolt | | |
| 8216 | Apartment or Exit or Public Toilet | |
| 8217 | Asylum or Institutional | |
| 8238 | Classroom Security Intruder | \$1,306.00 |
| 8259 | School Security | |
| 8290 | Classroom Security Holdback | |
| 8292 | All Purpose Holdback | |
| Double Cylinder With Deadbolt | | |
| 8226 | Store Door | |
| 8229 | Dummy Trim Deadlock | |
| 8239, 8240 | Classroom Security Intruder | |
| 8241 | Classroom Security | \$1,327.00 |
| 8246 | Dormitory or Exit | |
| 8248 | Store Door | |
| 8249 | Security | |
| 8252 | Institutional | |
| Electro Mechanical Single Cylinder – Specify 12V or 24V | | |
| 8270-12V / 8270-24V | Fail Safe | \$1,404.00 |
| 8271-12V / 8271-24V | Fail Secure | |
| Electro Mechanical Double Cylinder – Specify 12V or 24V | | |
| 8272-12V / 8272-24V | Fail Safe | \$1,461.00 |
| 8273-12V / 8273-24V | Fail Secure | |
| Non Keyed | | |
| 8213 | Communication or Exit | \$1,057.00 |
| 8215 | Passage or Closet | |
| 8265 | Privacy Bedroom or Bath (Latch) | \$1,155.00 |
| 8266, 8268 | Privacy Bedroom or Bath (Deadbolt) | \$1,188.00 |
| 8293* | Single Dummy Trim | \$443.00 |
| 8294 | Double Dummy Trim | \$887.00 |
| 8295 | Single Dummy Trim w/Lockbody | \$532.00 |
| 8296 | Double Dummy Trim w/Lockbody | \$980.00 |
| 8297 | Double Dummy w/Active Trim | \$1,057.00 |

ML-68 MORTISE LOCKS

SARGENT®

OPTIONS USA & Canada Prices Effective June 3, 2019

ASSA ABLOY

| Options | Description | Price |
|----------|---|-----------------------------------|
| 1▲ | 8200 Line with 1-1/16" wide front for 1-3/8" doors. | \$58.00 |
| 3 | Stainless steel hub (not available with 8289, 8291 & 8292 functions) | \$63.00 |
| 10▲ | SARGENT Signature Key System | \$58.00 / cyl. |
| 11†▲ | SARGENT XC Key System (not available with 10, 22, SC, SE options) | No addition |
| 1160 | SARGENT XC Large Format Interchangeable Plastic Disposable Construction Core | No addition |
| 1163 | SARGENT XC Large Format Interchangeable Core Cylinder - Includes masterkeying charges | \$77.00 |
| 1164 | SARGENT XC Large Format Interchangeable Construction Core Cylinder | \$77.00 |
| 1170 | Small Format interchangeable disposable construction core - to accept 7 Pin XC permanent core | No addition |
| 11727P | Small Format interchangeable keyed construction core - to accept 7 Pin XC permanent core | \$69.00 |
| 11737P | Small Format interchangeable core - to accept 7 pin XC permanent core | \$69.00 / cyl. |
| 21▲† | SARGENT Construction Key System (lost ball) Standard on all new systems established since 5/1/96 | \$16.00 / cyl. |
| 22▲† | SARGENT Construction Key System (split key) To be used on pre-established split key systems only | \$32.00 / cyl. |
| 23 | Locksets with flat 4 7/8" ANSI strike | No addition |
| 31 | Thick Doors - Extended Lip Required - Specify Length C to E | No addition |
| | - Cylinders - IMPORTANT- See catalog 7800/8200 option page for cylinder limitations | |
| | - Below charges DO NOT include additional charges for special cylinder requirements | |
| | Doors up to 2-1/2" thick - lock centered | No addition |
| | Doors 2-5/8" to 6" thick OR doors 1-3/4" thick w/max 1" paneling one side. | |
| | For example: Specify 1-3/4" door with panel (Side) on inside or outside | |
| | Non Keyed function \$50.00 Keyed function \$100.00 | |
| 60 | SARGENT Large Format Interchangeable Plastic Disposable Construction Core | No addition |
| 63 | SARGENT Large Format Interchangeable core cylinder, includes master keying charges | \$77.00 / cyl. |
| 64 | SARGENT Large Format Interchangeable Construction Core Cylinder | \$77.00 |
| 6573▲† | Small Format 6-Pin Uncombined Core (Refer to CK-12) | \$59.00 / cyl. |
| 65737P▲† | Small Format 7-Pin Uncombined Core (Refer to CK-12) | \$59.00 / cyl. |
| 68 | 8200 Line furnished with lever handle outside x knob inside (Excludes SLD Detention Knob) | Defaults to 8200 Lever Lock Price |
| 69 | 8200 Line furnished with lever handle inside x knob outside (Excludes SLD Detention Knob) | Defaults to 8200 Lever Lock Price |
| 70▲† | Small Format interchangeable disposable plastic construction core | No addition |
| 72▲† | Small Format interchangeable 6-pin construction core (7-pin with 11 option) | \$69.00 |
| 73▲† | Small Format interchangeable core 6-pin Includes MK and GMK keying charges | \$69.00 / cyl |
| 737P▲† | Small Format interchangeable core 7-pin (refer to CK-12 for available keyways) Includes MK and GMK keying charges | \$69.00 / cyl |
| 81▲† | Cylinder to accept Keso (83) and Keso F1 (F183) removable core – no core provided | No addition |
| F182† | SARGENT Keso Security Cylinder – patented – new key systems | \$84.00 / cyl. |
| F183▲† | SARGENT Keso Security Removable Core Cylinder – patented – new key systems | \$120.00 / cyl. |
| 82† | SARGENT Keso Security Cylinder (For existing systems only) | \$84.00 / cyl. |
| 83▲† | SARGENT Keso Security Removable Core Cylinder (For existing systems only) | \$120.00 / cyl. |
| 84▲† | SARGENT Keso Security Removable Construction Core Cylinder | See CK-18 |
| 85 | Tactile Warning - Abrasive coating on inside lever | \$45.00 |
| 86 | Tactile Warning - Abrasive coating on outside lever | \$45.00 |
| 87 | Tactile Warning - Abrasive coating on both levers | \$90.00 |
| AV | Anti Vandal Pull Trim (available in 32D finish), (Not available with 8270, 8271, 8272, 8273 functions) | \$212.00 |
| BR | SARGENT Bump Resistant Cylinders (N/A w/10, 22, 30, 60, 63, 64, 70, 72, 73, 737P, KESO, SC, & SE options) | \$23.00 / cyl. |
| DG1 | Patented Degree DG1 Key System | No Addition |
| DG160 | Hardware prepared for DG1-6300 Lg. Format IC cores, supplied with temporary plastic construction cores | No addition |
| DG163 | Patented Degree DG1 Large Format Interchangeable Core Cylinder - Includes master keying charges | \$77.00 |
| DG164 | Hardware prepared for DG1-6300 Lg. Format IC cores, supplied with temporary keyed construction cores | \$77.00 |
| DG2 | Patented Degree DG2 Key System incorporating a locking sidebar | \$58.00/cyl. |
| DG260 | Hardware prepared for DG2-6300 Lg. Format IC cores, supplied with temporary plastic construction cores | No addition |
| DG263 | Patented Degree DG2 Large Format Interchangeable Core Cylinder - Includes master keying charges | \$135.00 |
| DG264 | Hardware prepared for DG2-6300 Lg. Format IC cores, supplied with temporary keyed construction cores | \$77.00 |
| DG3 | Patented Degree DG3 Key System incorporating a locking sidebar and UL437 listed | \$82.00/cyl. |
| DG360 | Hardware prepared for DG3-6300 Lg. Format IC cores, supplied with temporary plastic construction cores | No addition |
| DG363 | Patented Degree DG3 Large Format Interchangeable Core Cylinder - Includes master keying charges | \$159.00 |
| DG364 | Hardware prepared for DG3-6300 Lg. Format IC cores, supplied with temporary keyed construction cores | \$77.00 |
| EMA* | "Lock" directional arrow engraving provided for outside LE1 escutcheon trim only | \$44.00 |
| EMB* | "Lock" directional arrow engraving provided for inside LE1 escutcheon trim only | \$44.00 |
| EMC* | "Lock" directional arrow engraving provided for both sides of LE1 escutcheon trim | \$88.00 |
| IDP | Integrated Door Position Switch | \$100.00 |
| LB | Extra large thumbturn | \$16.00 |
| LC | Less Cylinder | -\$89.00/cyl. |
| OBS | Open Back Strike | \$73.00 |
| PHR | Deadbolt Privacy Function (available w/deadbolt function only) | \$100.00 |
| R01 | Mercury and Lenel compatible 1KΩ/2KΩ resistance supervision | \$100.00 |
| R03 | Software House compatible 1KΩ/2KΩ resistance supervision | \$100.00 |
| R04 | AMAG compatible 4-state supervision | \$100.00 |
| SC▲† | Schlage "C" Keyway cylinder, (Number 41 Cylinder Only, 0 bitted) | No addition |
| SE▲† | Schlage "E" Keyway cylinder, (Number 41 Cylinder Only, 0 bitted) | No addition |
| SG | MicroShield® – an antimicrobial powder coat finish | \$67.00 |
| VNA | Status indicator provided for the outside LE1 escutcheon trim only | \$92.00 |
| VNB | Status indicator provided for the inside LE1 escutcheon trim only | \$92.00 |
| VNC | Status indicators provided for both sides of LE1 escutcheon trim | \$184.00 |
| WBS | Wrought Box Strike | No addition |

NOTES: ▲ Options not avail. with a standard 50 function lockout cylinder. † Not avail. with 60, 63, 64 options

| | | |
|-----|--|---------|
| CPC | Clear Powder Coat over 26D/32D – NAC-82280-24V x CEMD x RH x 32D x CPC All orders will continue to be handled as a "special" when CPC is ordered. | \$62.00 |
|-----|--|---------|

USA & Canada Prices Effective June 3, 2019

Esc. Design:

CE
TE
LE1

Lever Design:

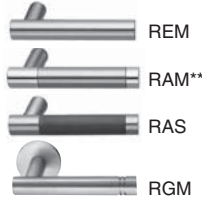

How to order Gramercy Series Levers:

Option: NAC x Function: 82280-24V x Esc.: CE x Lever: REM x Finish: 2930 x Hand: RH

See below for available finishes:

Lever Design Available Finishes

REM-RGM 2930 or 3030
RAM 2930*
RAS 29BK29, 30BK30

*Two-tone - grip of lever is 32D, balance of lever is 32. Rose/escutcheon and lock finish will be 32.

See catalog for finish description.

**RAM is not available in 10BE/BSP/WSP finish.

| NAC 8200 Electrified Mortise Locks with High Security Monitoring | | | | 10BE/BSP/WSP/ 629/630 |
|--|----------------|------------------------|--------------------------------------|--------------------------|
| Option | Function | Trim - Proximity Entry | Description | |
| NAC | 82270-12V/-24V | Rose x Lever Design | Fail Safe w/Cylinder Override | \$1,579.00 |
| NAC | 82271-12V/-24V | Rose x Lever Design | Fail Secure w/Cylinder Override | |
| NAC | 82280-12V/-24V | Rose x Lever Design | Fail Safe w/Deadbolt w/Cyl.Override | \$1,654.00 |
| NAC | 82281-12V/-24V | Rose x Lever Design | Fail Secure w/D.bolt w/Cyl.Override | |
| NAC | 82274-12V/-24V | Rose x Lever Design | Fail Safe - No Cylinder | \$1,524.00 |
| NAC | 82275-12V/-24V | Rose x Lever Design | Fail Secure - No Cylinder | |
| NAC | 82284-12V/-24V | Rose x Lever Design | Fail Safe w/Deadbolt - No Cylinder | \$1,599.00 |
| NAC | 82285-12V/-24V | Rose x Lever Design | Fail Secure w/Deadbolt - No Cylinder | |

Note: Consult catalog for ordering information.

Specify hand and voltage (12v or 24v) when ordering

ML-70 MORTISE LOCKS

SARGENT®

ASSA ABLOY

OPTIONS

USA & Canada Prices Effective June 3, 2019

| Options | Description | Price |
|----------|--|-----------------------------------|
| 1▲ | 8200 Line with 1-1/16" wide front for 1-3/8" doors. | \$58.00 |
| 3 | Stainless steel hub (not available with 8289, 8291 & 8292 functions) | \$63.00 |
| 10▲ | SARGENT Signature Key System | \$58.00 / cyl. |
| 11†▲ | SARGENT XC Key System (not available with 10, 22, SC, SE options) | No addition |
| 1160 | SARGENT XC Large Format Interchangeable Plastic Disposable Construction Core | No addition |
| 1163 | SARGENT XC Large Format Interchangeable Core Cylinder - Includes masterkeying charges | \$77.00 |
| 1164 | SARGENT XC Large Format Interchangeable Construction Core Cylinder | \$77.00 |
| 1170 | Small Format interchangeable disposable construction core - to accept 7 Pin XC permanent core | No addition |
| 11727P | Small Format interchangeable keyed construction core - to accept 7 Pin XC permanent core | \$69.00 |
| 11737P | Small Format interchangeable core - to accept 7 pin XC permanent core | \$69.00 / cyl. |
| 21▲† | SARGENT Construction Key System (lost ball) Standard on all new systems established since 5/1/96 | \$16.00 / cyl. |
| 22▲† | SARGENT Construction Key System (split key) To be used on pre-established split key systems only | \$32.00 / cyl. |
| 23 | Locksets with flat 4 7/8" ANSI strike | No addition |
| 31 | Thick Doors - Extended Lip Required - Specify Length C to E - Cylinders - IMPORTANT- See catalog 7800/8200 option page for cylinder limitations - Below charges DO NOT include additional charges for special cylinder requirements Doors up to 2-1/2" thick - lock centered Doors 2-5/8" to 6" thick OR doors 1-3/4" thick w/max 1" paneling one side. For example: Specify 1-3/4" door with panel (Side) on inside or outside | No addition |
| | Non Keyed function \$50.00 Keyed function \$100.00 | |
| 60 | SARGENT Large Format Interchangeable Plastic Disposable Construction Core | No addition |
| 63 | SARGENT Large Format Interchangeable core cylinder, includes master keying charges | \$77.00 / cyl. |
| 64 | SARGENT Large Format Interchangeable Construction Core Cylinder | \$77.00 |
| 6573▲† | Small Format 6-Pin Uncombined Core (Refer to CK-12) | \$59.00 / cyl. |
| 65737P▲† | Small Format 7-Pin Uncombined Core (Refer to CK-12) | \$59.00 / cyl. |
| 68 | 8200 Line furnished with lever handle outside x knob inside (Excludes SLD Detention Knob) | Defaults to 8200 Lever Lock Price |
| 69 | 8200 Line furnished with lever handle inside x knob outside (Excludes SLD Detention Knob) | Defaults to 8200 Lever Lock Price |
| 70▲† | Small Format Interchangeable disposable plastic construction core | No addition |
| 72▲† | Small Format interchangeable 6-pin construction core (7-pin with 11 option) | \$69.00 |
| 73▲† | Small Format interchangeable core 6-pin Includes MK and GMK keying charges | \$69.00 / cyl |
| 737P▲† | Small Format interchangeable core 7-pin (refer to CK-12 for available keyways) Includes MK and GMK keying charges | \$69.00 / cyl |
| 81▲† | Cylinder to accept Keso (83) and Keso F1 (F183) removable core – no core provided | No addition |
| F182† | SARGENT Keso Security Cylinder – patented – new key systems | \$84.00 / cyl. |
| F183▲† | SARGENT Keso Security Removable Core Cylinder – patented – new key systems | \$120.00 / cyl. |
| 82† | SARGENT Keso Security Cylinder (For existing systems only) | \$84.00 / cyl. |
| 83▲† | SARGENT Keso Security Removable Core Cylinder (For existing systems only) | \$120.00 / cyl. |
| 84▲† | SARGENT Keso Security Removable Construction Core Cylinder | See CK-18 |
| AV | Anti Vandal Pull Trim (available in 32D finish), (Not available with 8270, 8271, 8272, 8273 functions) | \$212.00 |
| BR | SARGENT Bump Resistant Cylinders (N/A w/10, 22, 30, 60, 63, 64, 70, 72, 73, 737P, KESO, SC, & SE options) | \$23.00 / cyl. |
| DG1 | Patented Degree DG1 Key System | No Addition |
| DG160 | Hardware prepared for DG1-6300 Lg. Format IC cores, supplied with temporary plastic construction cores | No addition |
| DG163 | Patented Degree DG1 Large Format Interchangeable Core Cylinder - Includes master keying charges | \$77.00 |
| DG164 | Hardware prepared for DG1-6300 Lg. Format IC cores, supplied with temporary keyed construction cores | \$77.00 |
| DG2 | Patented Degree DG2 Key System incorporating a locking sidebar | \$58.00/cyl. |
| DG260 | Hardware prepared for DG2-6300 Lg. Format IC cores, supplied with temporary plastic construction cores | No addition |
| DG263 | Patented Degree DG2 Large Format Interchangeable Core Cylinder - Includes master keying charges | \$135.00 |
| DG264 | Hardware prepared for DG2-6300 Lg. Format IC cores, supplied with temporary keyed construction cores | \$77.00 |
| DG3 | Patented Degree DG3 Key System incorporating a locking sidebar and UL437 listed | \$82.00/cyl. |
| DG360 | Hardware prepared for DG3-6300 Lg. Format IC cores, supplied with temporary plastic construction cores | No addition |
| DG363 | Patented Degree DG3 Large Format Interchangeable Core Cylinder - Includes master keying charges | \$159.00 |
| DG364 | Hardware prepared for DG3-6300 Lg. Format IC cores, supplied with temporary keyed construction cores | \$77.00 |
| DX | Deadbolt Monitoring (not available with 50, 74) | \$182.00 |
| EMA* | "Lock" directional arrow engraving provided for outside LE1 escutcheon trim only | \$44.00 |
| EMB* | "Lock" directional arrow engraving provided for inside LE1 escutcheon trim only | \$44.00 |
| EMC* | "Lock" directional arrow engraving provided for both sides of LE1 escutcheon trim | \$88.00 |
| LB | Extra large thumbturn | \$16.00 |
| LC | Less Cylinder | -\$89.00/cyl. |
| LX | Latchbolt Monitor – available with all non-deadbolt functions; not available with DX option | \$185.00 |
| OBS | Open Back Strike | \$73.00 |
| RX | Request to Exit | \$190.00 |
| SC▲† | Schlage "C" Keyway cylinder, (Number 41 Cylinder Only, 0 bitted) | No addition |
| SE▲† | Schlage "E" Keyway cylinder, (Number 41 Cylinder Only, 0 bitted) | No addition |
| SG | MicroShield® – an antimicrobial powder coat finish (Not available with RAL levers) | \$67.00 |
| VNA | Status indicator provided for the outside LE1 escutcheon trim only | \$92.00 |
| VNB | Status indicator provided for the inside LE1 escutcheon trim only | \$92.00 |
| VNC | Status indicators provided for both sides of LE1 escutcheon trim | \$184.00 |
| WBS | Wrought Box Strike | No addition |

NOTES: ▲ Options not avail. with a standard 50 function lockout cylinder. † Not avail. with 60, 63, 64 options

| | | |
|-----|--|---------|
| CPC | Clear Powder Coat over 26D/32D – 8205 x CERAG x RH x 32D x CPC All orders will continue to be handled as a "special" when CPC is ordered. | \$62.00 |
|-----|--|---------|

USA & Canada Prices Effective June 3, 2019

Esc. Design:

CE
TE
LE1

Lever Design:

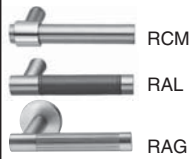

How to order Gramercy Series Levers:

Option: **6Q** x Function: **8204** x Esc.: **LE1** x Lever: **RCM** x Finish: **2929** x Hand: **RH**
See below for available finishes:

Lever Design Available Finishes

RCM 2929, 3030, or 2930*
RAL 29BK29, 29BN29, 30BK30, or 30BN30
RAG 2929 or 3030

*Two-tone - grip of lever is 32D, balance of lever is 32. Rose/escutcheon and lock finish will be 32. See catalog for finish description.

| Function – Single Cylinder | | Finish – 10BE/BSP/WSP/629/630 |
|---|------------------------------------|-------------------------------|
| 8204 | Storeroom or Closet | |
| 8205 | Office or Entry | \$1,284.00 |
| 8237 | Classroom | |
| 8255 | Office or Entry | |
| 8206 | Storeroom or Service | |
| 8231 | Utility | |
| 8236 | Closet | |
| 8256 | Office or Inner Entry | \$1,305.00 |
| 8257, 8258, 8267 | Institutional Privacy | |
| 8289 | Holdback | |
| 8291 | All Purpose Holdback | |
| Single Cylinder With Deadbolt | | |
| 8224 | Room Door | |
| 8225 | Dormitory or Exit | |
| 8227 | Closet or Storeroom | |
| 8228, 8230 | Dummy Trim Deadlock | |
| 8235 | Storeroom | \$1,333.00 |
| 8243 | Apartment Corridor | |
| 8245 | Dormitory or Exit | |
| 8247 | Front Door or Apartment Corridor | |
| 8251 | Storeroom Deadbolt | |
| 8250 | Hotel Guest Lock | \$1,362.00 |
| Double Cylinder No Deadbolt | | |
| 8216 | Apartment or Exit or Public Toilet | |
| 8217 | Asylum or Institutional | |
| 8238 | Classroom Security Intruder | \$1,381.00 |
| 8259 | School Security | |
| 8290 | Classroom Security Holdback | |
| 8292 | All Purpose Holdback | |
| Double Cylinder With Deadbolt | | |
| 8226 | Store Door | |
| 8229 | Dummy Trim Deadlock | |
| 8239, 8240 | Classroom Security Intruder | |
| 8241 | Classroom Security | \$1,400.00 |
| 8246 | Dormitory or Exit | |
| 8248 | Store Door | |
| 8249 | Security | |
| 8252 | Institutional | |
| Electro Mechanical Single Cylinder – Specify 12V or 24V | | |
| 8270-12V / 8270-24V | Fail Safe | \$1,480.00 |
| 8271-12V / 8271-24V | Fail Secure | |
| Electro Mechanical Double Cylinder – Specify 12V or 24V | | |
| 8272-12V / 8272-24V | Fail Safe | \$1,537.00 |
| 8273-12V / 8273-24V | Fail Secure | |
| Non Keyed | | |
| 8213 | Communication or Exit | \$1,130.00 |
| 8215 | Passage or Closet | |
| 8265 | Privacy Bedroom or Bath (Latch) | \$1,230.00 |
| 8266, 8268 | Privacy Bedroom or Bath (Deadbolt) | \$1,262.00 |
| 8293* | Single Dummy Trim | \$517.00 |
| 8294 | Double Dummy Trim | \$961.00 |
| 8295 | Single Dummy Trim w/Lockbody | \$606.00 |
| 8296 | Double Dummy Trim w/Lockbody | \$1,052.00 |
| 8297 | Double Dummy w/Active Trim | \$1,130.00 |

ML-72 MORTISE LOCKS

SARGENT®

OPTIONS USA & Canada Prices Effective June 3, 2019



ASSA ABLOY

| Options | Description | Price |
|----------|---|-----------------------------------|
| 1▲ | 8200 Line with 1-1/16" wide front for 1-3/8" doors. | \$58.00 |
| 3 | Stainless steel hub (not available with 8289, 8291 & 8292 functions) | \$63.00 |
| 10▲ | SARGENT Signature Key System | \$58.00 / cyl. |
| 11†▲ | SARGENT XC Key System (not available with 10, 22, SC, SE options) | No addition |
| 1160 | SARGENT XC Large Format Interchangeable Plastic Disposable Construction Core | No addition |
| 1163 | SARGENT XC Large Format Interchangeable Core Cylinder - Includes masterkeying charges | \$77.00 |
| 1164 | SARGENT XC Large Format Interchangeable Construction Core Cylinder | \$77.00 |
| 1170 | Small Format interchangeable disposable construction core - to accept 7 Pin XC permanent core | No addition |
| 11727P | Small Format interchangeable keyed construction core - to accept 7 Pin XC permanent core | \$69.00 |
| 11737P | Small Format interchangeable core - to accept 7 pin XC permanent core | \$69.00 / cyl. |
| 21▲† | SARGENT Construction Key System (lost ball) Standard on all new systems established since 5/1/96 | \$16.00 / cyl. |
| 22▲† | SARGENT Construction Key System (split key) To be used on pre-established split key systems only | \$32.00 / cyl. |
| 23 | Locksets with flat 4 7/8" ANSI strike | No addition |
| 31 | Thick Doors - Extended Lip Required - Specify Length C to E | No addition |
| | - Cylinders - IMPORTANT- See catalog 7800/8200 option page for cylinder limitations | |
| | - Below charges DO NOT include additional charges for special cylinder requirements | |
| | Doors up to 2-1/2" thick - lock centered | No addition |
| | Doors 2-5/8" to 6" thick OR doors 1-3/4" thick w/max 1" paneling one side. | |
| | For example: Specify 1-3/4" door with panel (Side) on inside or outside | |
| | Non Keyed function \$50.00 Keyed function \$100.00 | |
| 60 | SARGENT Large Format Interchangeable Plastic Disposable Construction Core | No addition |
| 63 | SARGENT Large Format Interchangeable core cylinder, includes master keying charges | \$77.00 / cyl. |
| 64 | SARGENT Large Format Interchangeable Construction Core Cylinder | \$77.00 |
| 6573▲† | Small Format 6-Pin Uncombined Core (Refer to CK-12) | \$59.00 / cyl. |
| 65737P▲† | Small Format 7-Pin Uncombined Core (Refer to CK-12) | \$59.00 / cyl. |
| 68 | 8200 Line furnished with lever handle outside x knob inside (Excludes SLD Detention Knob) | Defaults to 8200 Lever Lock Price |
| 69 | 8200 Line furnished with lever handle inside x knob outside (Excludes SLD Detention Knob) | Defaults to 8200 Lever Lock Price |
| 70▲† | Small Format interchangeable disposable plastic construction core | No addition |
| 72▲† | Small Format interchangeable 6-pin construction core (7-pin with 11 option) | \$69.00 |
| 73▲† | Small Format interchangeable core 6-pin Includes MK and GMK keying charges | \$69.00 / cyl |
| 737P▲† | Small Format interchangeable core 7-pin (refer to CK-12 for available keyways) Includes MK and GMK keying charges | \$69.00 / cyl |
| 81▲† | Cylinder to accept Keso (83) and Keso F1 (F183) removable core - no core provided | No addition |
| F182† | SARGENT Keso Security Cylinder - patented - new key systems | \$84.00 / cyl. |
| F183▲† | SARGENT Keso Security Removable Core Cylinder - patented - new key systems | \$120.00 / cyl. |
| 82† | SARGENT Keso Security Cylinder (For existing systems only) | \$84.00 / cyl. |
| 83▲† | SARGENT Keso Security Removable Core Cylinder (For existing systems only) | \$120.00 / cyl. |
| 84▲† | SARGENT Keso Security Removable Construction Core Cylinder | See CK-18 |
| 85 | Tactile Warning - Abrasive coating on inside lever | \$45.00 |
| 86 | Tactile Warning - Abrasive coating on outside lever | \$45.00 |
| 87 | Tactile Warning - Abrasive coating on both levers | \$90.00 |
| AV | Anti Vandal Pull Trim (available in 32D finish), (Not available with 8270, 8271, 8272, 8273 functions) | \$212.00 |
| BR | SARGENT Bump Resistant Cylinders (N/A w/10, 22, 30, 60, 63, 64, 70, 72, 73, 737P, KESO, SC, & SE options) | \$23.00 / cyl. |
| DG1 | Patented Degree DG1 Key System | No Addition |
| DG160 | Hardware prepared for DG1-6300 Lg. Format IC cores, supplied with temporary plastic construction cores | No addition |
| DG163 | Patented Degree DG1 Large Format Interchangeable Core Cylinder - Includes master keying charges | \$77.00 |
| DG164 | Hardware prepared for DG1-6300 Lg. Format IC cores, supplied with temporary keyed construction cores | \$77.00 |
| DG2 | Patented Degree DG2 Key System incorporating a locking sidebar | \$58.00/cyl. |
| DG260 | Hardware prepared for DG2-6300 Lg. Format IC cores, supplied with temporary plastic construction cores | No addition |
| DG263 | Patented Degree DG2 Large Format Interchangeable Core Cylinder - Includes master keying charges | \$135.00 |
| DG264 | Hardware prepared for DG2-6300 Lg. Format IC cores, supplied with temporary keyed construction cores | \$77.00 |
| DG3 | Patented Degree DG3 Key System incorporating a locking sidebar and UL437 listed | \$82.00/cyl. |
| DG360 | Hardware prepared for DG3-6300 Lg. Format IC cores, supplied with temporary plastic construction cores | No addition |
| DG363 | Patented Degree DG3 Large Format Interchangeable Core Cylinder - Includes master keying charges | \$159.00 |
| DG364 | Hardware prepared for DG3-6300 Lg. Format IC cores, supplied with temporary keyed construction cores | \$77.00 |
| EMA* | "Lock" directional arrow engraving provided for outside LE1 escutcheon trim only | \$44.00 |
| EMB* | "Lock" directional arrow engraving provided for inside LE1 escutcheon trim only | \$44.00 |
| EMC* | "Lock" directional arrow engraving provided for both sides of LE1 escutcheon trim | \$88.00 |
| IDP | Integrated Door Position Switch | \$100.00 |
| LB | Extra large thumbturn | \$16.00 |
| LC | Less Cylinder | -\$89.00/cyl. |
| OBS | Open Back Strike | \$73.00 |
| PHR | Deadbolt Privacy Function (available w/deadbolt function only) | \$100.00 |
| R01 | Mercury and Lenel compatible 1KΩ/2KΩ resistance supervision | \$100.00 |
| R03 | Software House compatible 1KΩ/2KΩ resistance supervision | \$100.00 |
| R04 | AMAG compatible 4-state supervision | \$100.00 |
| SC▲† | Schlage "C" Keyway cylinder, (Number 41 Cylinder Only, 0 bitted) | No addition |
| SE▲† | Schlage "E" Keyway cylinder, (Number 41 Cylinder Only, 0 bitted) | No addition |
| SG | MicroShield® - an antimicrobial powder coat finish | \$67.00 |
| VNA | Status indicator provided for the outside LE1 escutcheon trim only | \$92.00 |
| VNB | Status indicator provided for the inside LE1 escutcheon trim only | \$92.00 |
| VNC | Status indicators provided for both sides of LE1 escutcheon trim | \$184.00 |
| WBS | Wrought Box Strike | No addition |

NOTES: ▲ Options not avail. with a standard 50 function lockout cylinder. † Not avail. with 60, 63, 64 options

| | | |
|-----|--|---------|
| CPC | Clear Powder Coat over 26D/32D - NAC-82280-24V x CEMD x RH x 32D x CPC | \$62.00 |
| | All orders will continue to be handled as a "special" when CPC is ordered. | |

USA & Canada Prices Effective June 3, 2019

| Esc. Design: | Lever Design: | How to order Gramercy Series Levers: |
|--------------|---|---|
| CE |  RCM | Option: NAC x Function: 82271-12V x Esc.: LE1 x Lever: RCM x Finish: 2929 x Hand: RH |
| TE |  RAL | See below for available finishes: |
| LE1 |  RAG | Lever Design Available Finishes |
| | | RCM 2929, 3030, or 2930* |
| | | RAL 29BK29, 29BN29, 30BK30, or 30BN30 |
| | | RAG 2929 or 3030 |
| | | *Two-tone - grip of lever is 32D, balance of lever is 32. Rose/escutcheon and lock finish will be 32. See catalog for finish description. |

| NAC 8200 Electrified Mortise Locks with High Security Monitoring | | | | 10BE/BSP/WSP/ 629/630 |
|--|----------------|------------------------|--------------------------------------|--------------------------|
| Option | Function | Trim - Proximity Entry | Description | |
| NAC | 82270-12V/-24V | Rose x Lever Design | Fail Safe w/Cylinder Override | \$1,655.00 |
| NAC | 82271-12V/-24V | Rose x Lever Design | Fail Secure w/Cylinder Override | |
| NAC | 82280-12V/-24V | Rose x Lever Design | Fail Safe w/Deadbolt w/Cyl.Override | \$1,730.00 |
| NAC | 82281-12V/-24V | Rose x Lever Design | Fail Secure w/D.bolt w/Cyl.Override | |
| NAC | 82274-12V/-24V | Rose x Lever Design | Fail Safe - No Cylinder | \$1,600.00 |
| NAC | 82275-12V/-24V | Rose x Lever Design | Fail Secure - No Cylinder | |
| NAC | 82284-12V/-24V | Rose x Lever Design | Fail Safe w/Deadbolt - No Cylinder | \$1,675.00 |
| NAC | 82285-12V/-24V | Rose x Lever Design | Fail Secure w/Deadbolt - No Cylinder | |

Note: Consult catalog for ordering information.
Specify hand and voltage (12v or 24v) when ordering

ML-74 MORTISE LOCKS

SARGENT®

ASSA ABLOY

OPTIONS

USA & Canada Prices Effective June 3, 2019

| Options | Description | Price |
|----------|--|--|
| 10▲ | SARGENT Signature Key System | \$58.00 / cyl. |
| 11†▲ | SARGENT XC Key System (not available with 10, 22, SC, SE options) | No addition |
| 1160 | SARGENT XC Large Format Interchangeable Plastic Disposable Construction Core | No addition |
| 1163 | SARGENT XC Large Format Interchangeable Core Cylinder - Includes masterkeying charges | \$77.00 |
| 1164 | SARGENT XC Large Format Interchangeable Construction Core Cylinder | \$77.00 |
| 1170 | Small Format interchangeable disposable construction core - to accept 7 Pin XC permanent core | No addition |
| 11727P | Small Format interchangeable keyed construction core - to accept 7 Pin XC permanent core | \$69.00 |
| 11737P | Small Format interchangeable core - to accept 7 pin XC permanent core | \$69.00 /cyl. |
| 21▲† | SARGENT Construction Key System (lost ball) Standard on all new systems established since 5/1/96 | \$16.00 / cyl. |
| 22▲† | SARGENT Construction Key System (split key) To be used on pre-established split key systems only | \$32.00 / cyl. |
| 23 | Locksets with flat 4 7/8" ANSI strike | No addition |
| 31 | Thick Doors - Extended Lip Required - Specify Length C to E - Cylinders - IMPORTANT- See catalog 7800/8200 option page for cylinder limitations - Below charges DO NOT include additional charges for special cylinder requirements Doors up to 2-1/2" thick - lock centered Doors 2-5/8" to 6" thick OR doors 1-3/4" thick w/max 1" paneling one side. For example: Specify 1-3/4" door with panel (Side) on inside or outside | No addition Non Keyed function \$50.00 Keyed function \$100.00 |
| 49 | Visual Status Indicator (available with 26, 29, 30, 36, 37, 38, 39, 40, 41 functions) or Occupancy Indicator with Emergency Release (available with 65, 66, 68 functions) | \$92.00 |
| 60 | SARGENT Large Format Interchangeable Plastic Disposable Construction Core | No addition |
| 63 | SARGENT Large Format Interchangeable core cylinder, includes master keying charges | \$77.00 / cyl. |
| 64 | SARGENT Large Format Interchangeable Construction Core Cylinder | \$77.00 |
| 6573▲† | Small Format 6-Pin Uncombined Core (Refer to CK-12) | \$59.00 / cyl. |
| 65737P▲† | Small Format 7-Pin Uncombined Core (Refer to CK-12) | \$59.00 / cyl. |
| 70▲† | Small Format Interchangeable disposable plastic construction core | No addition |
| 72▲† | Small Format Interchangeable 6-pin construction core (7-pin with 11 option) | See CK-2 |
| 73▲† | Small Format interchangeable core 6-pin Includes MK and GMK keying charges | \$69.00 / cyl |
| 737P▲† | Small Format interchangeable core 7-pin (refer to CK-12 for available keyways) Includes MK and GMK keying charges | \$69.00 / cyl |
| 81▲† | Cylinder to accept Keso (83) and Keso F1 (F183) removable core – no core provided | No Addition |
| F182† | SARGENT Keso Security Cylinder – patented – new key systems | \$84.00 / cyl. |
| F183▲† | SARGENT Keso Security Removable Core Cylinder – patented – new key systems | \$120.00 / cyl. |
| 82† | SARGENT Keso Security Cylinder (For existing systems only) | \$84.00 / cyl. |
| 83▲† | SARGENT Keso Security Removable Core Cylinder (For existing systems only) | \$120.00 / cyl. |
| 84▲† | SARGENT Keso Security Removable Construction Core Cylinder | See page CK-18 |
| 85 | Tactile Warning - Abrasive coating on inside lever | \$45.00 |
| 86 | Tactile Warning - Abrasive coating on outside lever | \$45.00 |
| 87 | Tactile Warning - Abrasive coating on both levers | \$90.00 |
| BR | SARGENT Bump Resistant Cylinders (N/A w/10, 22, 30, 60, 63, 64, 70, 72, 73, 737P, KESO, SC, & SE options) | \$23.00 /cyl. |
| DG1 | Patented Degree DG1 Key System | No Addition |
| DG160 | Hardware prepared for DG1-6300 Lg. Format IC cores, supplied with temporary plastic construction cores | No addition |
| DG163 | Patented Degree DG1 Large Format Interchangeable Core Cylinder - Includes master keying charges | \$77.00 |
| DG164 | Hardware prepared for DG1-6300 Lg. Format IC cores, supplied with temporary keyed construction cores | \$77.00 |
| DG2 | Patented Degree DG2 Key System incorporating a locking sidebar | \$58.00/cyl. |
| DG260 | Hardware prepared for DG2-6300 Lg. Format IC cores, supplied with temporary plastic construction cores | No addition |
| DG263 | Patented Degree DG2 Large Format Interchangeable Core Cylinder - Includes master keying charges | \$135.00 |
| DG264 | Hardware prepared for DG2-6300 Lg. Format IC cores, supplied with temporary keyed construction cores | \$77.00 |
| DG3 | Patented Degree DG3 Key System incorporating a locking sidebar and UL437 listed | \$82.00/cyl. |
| DG360 | Hardware prepared for DG3-6300 Lg. Format IC cores, supplied with temporary plastic construction cores | No addition |
| DG363 | Patented Degree DG3 Large Format Interchangeable Core Cylinder - Includes master keying charges | \$159.00 |
| DG364 | Hardware prepared for DG3-6300 Lg. Format IC cores, supplied with temporary keyed construction cores | \$77.00 |
| DX | Deadbolt Monitoring (not available with LX option) | \$182.00 |
| LC | Less Cylinder | -\$89.00/cyl. |
| LB | Extra large thumbturn | \$16.00 |
| LX | Latchbolt Monitor – available with all non-deadbolt functions; not available with DX option | \$185.00 |
| OBS | Open Back Strike | \$73.00 |
| RX | Request to Exit | \$190.00 |
| SC▲† | Schlage "C" Keyway cylinder, (Number 41 Cylinder Only, 0 bitted) | No addition |
| SE▲† | Schlage "E" Keyway cylinder, (Number 41 Cylinder Only, 0 bitted) | No addition |
| SG | MicroShield® – an antimicrobial powder coat finish | \$67.00 |
| T1 | Decorative thumbturn; backplate matches rose design chosen | No Addition |
| T2 | Decorative square thumbturn; backplate matches rose design chosen | No Addition |
| T3 | Decorative cylinder thumbturn; backplate matches rose design chosen | No Addition |
| WBS | Wrought Box Strike | No addition |

NOTES: ▲ Options not available with a standard 50 function lockout cylinder. † Not available with 60, 63, 64 options.
** Specify "R" for Mortise Locks compatible with roseless collar.

CPC Clear Powder Coat over 26/26D – R8205 x R** G x RH x 26D x CPC \$62.00
All orders will continue to be handled as a "special" when CPC is ordered.

SIMPLÍ™ ROSELESS TRIM R8200 MORTISE LOCK - COASTAL SERIES

USA & Canada Prices Effective June 3, 2019

Lever Designs:

*G, R, *S, *Y Levers



RG
Collar: R
Lever: G

How to order:

21-R8205 x R G x RH x 26D**
Option: 21
Function: R8205
Rose: R**
Lever: G
Hand: RH
Finish: 26D

* Handed: specify hand when ordering

** Specify "R" for Mortise Locks compatible with roseless collar.

| Function | | Finish | |
|---|------------------------------------|------------------|-----------------------------------|
| | | 10BE/26D/BSP/WSP | 03/04/09/10/10B/10BL/14/15/20D/26 |
| Single Cyl | | | |
| R8204 | Storeroom or Closet | | |
| R8205 | Office or Entry | \$1,082.00 | \$1,106.00 |
| R8237 | Classroom | | |
| R8255 | Office or Entry | | |
| R8206 | Storeroom or Service | | |
| R8231 | Utility | | |
| R8236 | Closet | | |
| R8256 | Office or Inner Entry | \$1,109.00 | \$1,133.00 |
| R8257, R8258, R8267 | Institutional Privacy | | |
| Single Cyl With Deadbolt | | | |
| R8224 | Room Door | | |
| R8225 | Dormitory or Exit | | |
| R8227 | Closet or Storeroom | | |
| R8228, R8230 | Dummy Trim Deadlock | | |
| R8235 | Storeroom | \$1,136.00 | \$1,160.00 |
| R8243 | Apartment Corridor | | |
| R8245 | Dormitory or Exit | | |
| R8247 | Front Door or Apartment Corridor | | |
| R8251 | Storeroom Deadbolt | | |
| R8250 | Hotel Guest Lock | \$1,174.00 | \$1,198.00 |
| Double Cyl No Deadbolt | | | |
| R8216 | Apartment or Exit or Public Toilet | | |
| R8217 | Asylum or Institutional | | |
| R8238 | Classroom Security Intruder | \$1,191.00 | \$1,215.00 |
| R8259 | School Security | | |
| Double Cyl With Deadbolt | | | |
| R8226 | Store Door | | |
| R8229 | Dummy Trim Deadlock | | |
| R8239, R8240 | Classroom Security Intruder | | |
| R8241 | Classroom Security | \$1,214.00 | \$1,238.00 |
| R8246 | Dormitory or Exit | | |
| R8248 | Store Door | | |
| R8249 | Security | | |
| R8252 | Institutional | | |
| Electro Mechanical Single Cyl – Specify 12V or 24V | | | |
| R8270-12V / R8270-24V | Fail Safe | \$1,278.00 | \$1,302.00 |
| R8271-12V / R8271-24V | Fail Secure | | |
| Electro Mechanical Double Cyl – Specify 12V or 24V | | | |
| R8272-12V / R8272-24V | Fail Safe | \$1,335.00 | \$1,359.00 |
| R8273-12V / R8273-24V | Fail Secure | | |
| Non Keyed | | | |
| R8213 | Communication or Exit | \$874.00 | \$898.00 |
| R8215 | Passage or Closet | | |
| R8265 | Privacy Bedroom or Bath (Latch) | \$961.00 | \$985.00 |
| R8266, R8268 | Privacy Bedroom or Bath (Deadbolt) | \$1,058.00 | \$1,082.00 |
| R8293* | Single Dummy Trim | \$356.00 | \$368.00 |
| R8294 | Double Dummy Trim | \$714.00 | \$738.00 |
| R8295 | Single Dummy Trim w/Lockbody | \$460.00 | \$472.00 |
| R8296 | Double Dummy Trim w/Lockbody | \$820.00 | \$844.00 |
| R8297 | Double Dummy w/Active Trim | \$908.00 | \$932.00 |

ML-76 MORTISE LOCKS

SARGENT®

ASSA ABLOY

OPTIONS

USA & Canada Prices Effective June 3, 2019

| Options | Description | Price |
|----------|---|--|
| 10▲ | SARGENT Signature Key System | \$58.00 / cyl. |
| 11†▲ | SARGENT XC Key System (not available with 10, 22, SC, SE options) | No addition |
| 1160 | SARGENT XC Large Format Interchangeable Plastic Disposable Construction Core | No addition |
| 1163 | SARGENT XC Large Format Interchangeable Core Cylinder - Includes masterkeying charges | \$77.00 |
| 1164 | SARGENT XC Large Format Interchangeable Construction Core Cylinder | \$77.00 |
| 1170 | Small Format interchangeable disposable construction core - to accept 7 Pin XC permanent core | No addition |
| 11727P | Small Format interchangeable keyed construction core - to accept 7 Pin XC permanent core | \$69.00 |
| 11737P | Small Format interchangeable core - to accept 7 pin XC permanent core | \$69.00 / cyl. |
| 21▲† | SARGENT Construction Key System (lost ball) Standard on all new systems established since 5/1/96 | \$16.00 / cyl. |
| 22▲† | SARGENT Construction Key System (split key) To be used on pre-established split key systems only | \$32.00 / cyl. |
| 23 | Locksets with flat 4 7/8" ANSI strike | No addition |
| 31 | Thick Doors - Extended Lip Required - Specify Length C to E - Cylinders - IMPORTANT- See catalog 7800/8200 option page for cylinder limitations - Below charges DO NOT include additional charges for special cylinder requirements | No addition |
| | Doors up to 2-1/2" thick - lock centered | No addition |
| | Doors 2-5/8" to 6" thick OR doors 1-3/4" thick w/max 1" paneling one side. For example: Specify 1-3/4" door with panel (Side) on inside or outside | Non Keyed function \$50.00 Keyed function \$100.00 |
| 49 | Visual Status Indicator (available with 26, 29, 30, 36, 37, 38, 39, 40, 41 functions) or Occupancy Indicator with Emergency Release (available with 65, 66, 68 functions) | \$92.00 |
| 60 | SARGENT Large Format Interchangeable Plastic Disposable Construction Core | No addition |
| 63 | SARGENT Large Format Interchangeable core cylinder, includes master keying charges | \$77.00 / cyl. |
| 64 | SARGENT Large Format Interchangeable Construction Core Cylinder | \$77.00 |
| 6573▲† | Small Format 6-Pin Uncombined Core (Refer to CK-12) | \$59.00 / cyl. |
| 65737P▲† | Small Format 7-Pin Uncombined Core (Refer to CK-12) | \$59.00 / cyl. |
| 70▲† | Small Format Interchangeable disposable plastic construction core | No addition |
| 72▲† | Small Format Interchangeable 6-pin construction core (7-pin with 11 option) | See CK-2 |
| 73▲† | Small Format interchangeable core 6-pin Includes MK and GMK keying charges | \$69.00 / cyl |
| 737P▲† | Small Format interchangeable core 7-pin (refer to CK-12 for available keyways) Includes MK and GMK keying charges | \$69.00 / cyl |
| 81▲† | Cylinder to accept Keso (83) and Keso F1 (F183) removable core – no core provided | No addition |
| F182† | SARGENT Keso Security Cylinder – patented – new key systems | \$84.00 / cyl. |
| F183▲† | SARGENT Keso Security Removable Core Cylinder – patented – new key systems | \$120.00 / cyl. |
| 82† | SARGENT Keso Security Cylinder (For existing systems only) | \$84.00 / cyl. |
| 83▲† | SARGENT Keso Security Removable Core Cylinder (For existing systems only) | \$120.00 / cyl. |
| 84▲† | SARGENT Keso Security Removable Construction Core Cylinder | See CK-18 |
| 85 | Tactile Warning - Abrasive coating on inside lever | \$45.00 |
| 86 | Tactile Warning - Abrasive coating on outside lever | \$45.00 |
| 87 | Tactile Warning - Abrasive coating on both levers | \$90.00 |
| BR | SARGENT Bump Resistant Cylinders (N/A w/10, 22, 30, 60, 63, 64, 70, 72, 73, 737P, KESO, SC, & SE options) | \$23.00 / cyl. |
| DG1 | Patented Degree DG1 Key System | No Addition |
| DG160 | Hardware prepared for DG1-6300 Lg. Format IC cores, supplied with temporary plastic construction cores | No addition |
| DG163 | Patented Degree DG1 Large Format Interchangeable Core Cylinder - Includes master keying charges | \$77.00 |
| DG164 | Hardware prepared for DG1-6300 Lg. Format IC cores, supplied with temporary keyed construction cores | \$77.00 |
| DG2 | Patented Degree DG2 Key System incorporating a locking sidebar | \$58.00/cyl. |
| DG260 | Hardware prepared for DG2-6300 Lg. Format IC cores, supplied with temporary plastic construction cores | No addition |
| DG263 | Patented Degree DG2 Large Format Interchangeable Core Cylinder - Includes master keying charges | \$135.00 |
| DG264 | Hardware prepared for DG2-6300 Lg. Format IC cores, supplied with temporary keyed construction cores | \$77.00 |
| DG3 | Patented Degree DG3 Key System incorporating a locking sidebar and UL437 listed | \$82.00/cyl. |
| DG360 | Hardware prepared for DG3-6300 Lg. Format IC cores, supplied with temporary plastic construction cores | No addition |
| DG363 | Patented Degree DG3 Large Format Interchangeable Core Cylinder - Includes master keying charges | \$159.00 |
| DG364 | Hardware prepared for DG3-6300 Lg. Format IC cores, supplied with temporary keyed construction cores | \$77.00 |
| DX | Deadbolt Monitoring (not available with LX option) | \$182.00 |
| LC | Less Cylinder | -\$89.00/cyl. |
| LB | Extra large thumbturn | \$16.00 |
| LX | Latchbolt Monitor – available with all non-deadbolt functions; not available with DX option | \$185.00 |
| OBS | Open Back Strike | \$73.00 |
| RX | Request to Exit | \$190.00 |
| SC▲† | Schlage "C" Keyway cylinder, (Number 41 Cylinder Only, 0 bitted) | No addition |
| SE▲† | Schlage "E" Keyway cylinder, (Number 41 Cylinder Only, 0 bitted) | No addition |
| SG | MicroShield® – an antimicrobial powder coat finish | \$67.00 |
| T1 | Decorative thumbturn; backplate matches rose design chosen | No Addition |
| T2 | Decorative square thumbturn; backplate matches rose design chosen | No Addition |
| T3 | Decorative cylinder thumbturn; backplate matches rose design chosen | No Addition |
| WBS | Wrought Box Strike | No addition |

NOTES: ▲ Options not avail. with a standard 50 function lockout cylinder. † Not avail. with 60, 63, 64 options
** Specify "R" for Mortise Locks compatible with roseless collar.

CPC Clear Powder Coat over 26D/32D – R8205 x R** MM x RH x 32D x CPC \$62.00
All orders will continue to be handled as a "special" when CPC is ordered.

ASSA ABLOY

SIMPLÍ™ ROSELESS TRIM R8200 MORTISE LOCKS - STUDIO COLLECTION LEVERS

USA & Canada Prices Effective June 3, 2019



RMI

Collar: R
Lever: MI



RMO

Roseless Trim: R
Lever: MO

Lever Designs:

| Centro | Notting Hill | Aventura | Rialto | Odeon |
|--------|--------------|----------|--------|-------|
| MD | *MQ | MB | MO | *MH |
| MJ | *MM | ME | *MZ | *MS |
| ND | *MY | MF | | *MU |
| NJ | | MG | | *MV |
| | | MI | | *MX |
| | | MW | | *NS |
| | | NF | | *NU |

* Handed: specify hand when ordering

How to order: 21-R8205 x R** MM x RH x 26D

| | |
|----------|-------|
| Option | 21 |
| Function | R8205 |
| Rose | R** |
| Lever | MM |
| Hand | RH |
| Finish | 26D |

** Specify "R" for Mortise Locks compatible with roseless collar.

| Function | | Finish | |
|---|------------------------------------|------------------|--|
| Single Cyl | | 10BE/26D/BSP/WSP | 03/04/09/10/10B/10BL/14/15/20D/26/32/32D |
| R8204 | Storeroom or Closet | | |
| R8205 | Office or Entry | \$1,082.00 | \$1,106.00 |
| R8237 | Classroom | | |
| R8255 | Office or Entry | | |
| R8206 | Storeroom or Service | | |
| R8231 | Utility | | |
| R8236 | Closet | | |
| R8256 | Office or Inner Entry | \$1,109.00 | \$1,133.00 |
| R8257, R8258, R8267 | Institutional Privacy | | |
| Single Cyl With Deadbolt | | | |
| R8224 | Room Door | | |
| R8225 | Dormitory or Exit | | |
| R8227 | Closet or Storeroom | | |
| R8228, R8230 | Dummy Trim Deadlock | | |
| R8235 | Storeroom | \$1,136.00 | \$1,160.00 |
| R8243 | Apartment Corridor | | |
| R8245 | Dormitory or Exit | | |
| R8247 | Front Door or Apartment Corridor | | |
| R8251 | Storeroom Deadbolt | | |
| R8250 | Hotel Guest Lock | \$1,174.00 | \$1,198.00 |
| Double Cyl No Deadbolt | | | |
| R8216 | Apartment or Exit or Public Toilet | | |
| R8217 | Asylum or Institutional | | |
| R8238 | Classroom Security Intruder | \$1,191.00 | \$1,215.00 |
| R8259 | School Security | | |
| Double Cyl With Deadbolt | | | |
| R8226 | Store Door | | |
| R8229 | Dummy Trim Deadlock | | |
| R8239, R8240 | Classroom Security Intruder | | |
| R8241 | Classroom Security | \$1,214.00 | \$1,238.00 |
| R8246 | Dormitory or Exit | | |
| R8248 | Store Door | | |
| R8249 | Security | | |
| R8252 | Institutional | | |
| Electro Mechanical Single Cyl – Specify 12V or 24V | | | |
| R8270-12V / R8270-24V | Fail Safe | \$1,278.00 | \$1,302.00 |
| R8271-12V / R8271-24V | Fail Secure | | |
| Electro Mechanical Double Cyl – Specify 12V or 24V | | | |
| R8272-12V / R8272-24V | Fail Safe | \$1,335.00 | \$1,359.00 |
| R8273-12V / R8273-24V | Fail Secure | | |
| Non Keyed | | | |
| R8213 | Communication or Exit | \$874.00 | \$898.00 |
| R8215 | Passage or Closet | | |
| R8265 | Privacy Bedroom or Bath (Latch) | \$961.00 | \$985.00 |
| R8266, R8268 | Privacy Bedroom or Bath (Deadbolt) | \$1,058.00 | \$1,082.00 |
| R8293* | Single Dummy Trim | \$356.00 | \$368.00 |
| R8294 | Double Dummy Trim | \$714.00 | \$738.00 |
| R8295 | Single Dummy Trim w/Lockbody | \$460.00 | \$472.00 |
| R8296 | Double Dummy Trim w/Lockbody | \$820.00 | \$844.00 |
| R8297 | Double Dummy w/Active Trim | \$908.00 | \$932.00 |

ML-78 MORTISE LOCKS

SARGENT®

OPTIONS USA & Canada Prices Effective June 3, 2019

ASSA ABLOY

| Options | Description | Price |
|----------|--|---|
| 1▲ | 8200 Line with 1-1/16" wide front for 1-3/8" doors. | \$58.00 |
| 3 | Stainless steel hub (not available with 8289, 8291 & 8292 functions) | \$63.00 |
| 10▲ | SARGENT Signature Key System | \$58.00 / cyl. |
| 11†▲ | SARGENT XC Key System (not available with 10, 22, SC, SE options) | No addition |
| 1160 | SARGENT XC Large Format Interchangeable Plastic Disposable Construction Core | No addition |
| 1163 | SARGENT XC Large Format Interchangeable Core Cylinder - Includes masterkeying charges | \$77.00 |
| 1164 | SARGENT XC Large Format Interchangeable Construction Core Cylinder | \$77.00 |
| 1170 | Small Format interchangeable disposable construction core - to accept 7 Pin XC permanent core | No addition |
| 11727P | Small Format interchangeable keyed construction core - to accept 7 Pin XC permanent core | \$69.00 |
| 11737P | Small Format interchangeable core - to accept 7 pin XC permanent core | \$69.00 /cyl. |
| 21▲† | SARGENT Construction Key System (lost ball) Standard on all new systems established since 5/1/96 | \$16.00 / cyl. |
| 22▲† | SARGENT Construction Key System (split key) To be used on pre-established split key systems only | \$32.00 / cyl. |
| 23 | Locksets with flat 4 7/8" ANSI strike | No addition |
| 31 | Thick Doors - Extended Lip Required - Specify Length C to E - Cylinders - IMPORTANT- See catalog 7800/8200 option page for cylinder limitations - Below charges DO NOT include additional charges for special cylinder requirements Doors up to 2-1/2" thick - lock centered Doors 2-5/8" to 6" thick OR doors 1-3/4" thick w/max 1" paneling one side. For example: Specify 1-3/4" door with panel (Side) on inside or outside | No addition Non Keyed function \$50.00 Keyed function \$100.00 |
| 60 | SARGENT Large Format Interchangeable Plastic Disposable Construction Core | No addition |
| 63 | SARGENT Large Format Interchangeable core cylinder, includes master keying charges | \$77.00 / cyl. |
| 64 | SARGENT Large Format Interchangeable Construction Core Cylinder | \$77.00 |
| 6573▲† | Small Format 6-Pin Uncombined Core (Refer to CK-12) | \$59.00 / cyl. |
| 65737P▲† | Small Format 7-Pin Uncombined Core (Refer to CK-12) | \$59.00 / cyl. |
| 68 | 8200 Line furnished with lever handle outside x knob inside (Excludes SLD Detention Knob) | Defaults to 8200 Lever Lock Price |
| 69 | 8200 Line furnished with lever handle inside x knob outside (Excludes SLD Detention Knob) | Defaults to 8200 Lever Lock Price |
| 70▲† | Small Format Interchangeable disposable plastic construction core | No addition |
| 72▲† | Small Format Interchangeable 6-pin construction core (7-pin with 11 option) | \$69.00 |
| 73▲† | Small Format interchangeable core 6-pin Includes MK and GMK keying charges | \$69.00 / cyl |
| 737P▲† | Small Format interchangeable core 7-pin (refer to CK-12 for available keyways) Includes MK and GMK keying charges | \$69.00 / cyl |
| 81▲† | Cylinder to accept Keso (83) and Keso F1 (F183) removable core – no core provided | No addition |
| F182† | SARGENT Keso Security Cylinder – patented – new key systems | \$84.00 / cyl. |
| F183▲† | SARGENT Keso Security Removable Core Cylinder – patented – new key systems | \$120.00 / cyl. |
| 82† | SARGENT Keso Security Cylinder (For existing systems only) | \$84.00 / cyl. |
| 83▲† | SARGENT Keso Security Removable Core Cylinder (For existing systems only) | \$120.00 / cyl. |
| 84▲† | SARGENT Keso Security Removable Construction Core Cylinder | See CK-18 |
| 85 | Tactile Warning - Abrasive coating on inside lever | \$45.00 |
| 86 | Tactile Warning - Abrasive coating on outside lever | \$45.00 |
| 87 | Tactile Warning - Abrasive coating on both levers | \$90.00 |
| AV | Anti Vandal Pull Trim (available in 32D finish), (Not available with 8270, 8271, 8272, 8273 functions) | \$212.00 |
| BR | SARGENT Bump Resistant Cylinders (N/A w/10, 22, 30, 60, 63, 64, 70, 72, 73, 737P, KESO, SC, & SE options) | \$23.00 /cyl. |
| DG1 | Patented Degree DG1 Key System | No Addition |
| DG160 | Hardware prepared for DG1-6300 Lg. Format IC cores, supplied with temporary plastic construction cores | No addition |
| DG163 | Patented Degree DG1 Large Format Interchangeable Core Cylinder - Includes master keying charges | \$77.00 |
| DG164 | Hardware prepared for DG1-6300 Lg. Format IC cores, supplied with temporary keyed construction cores | \$77.00 |
| DG2 | Patented Degree DG2 Key System incorporating a locking sidebar | \$58.00/cyl. |
| DG260 | Hardware prepared for DG2-6300 Lg. Format IC cores, supplied with temporary plastic construction cores | No addition |
| DG263 | Patented Degree DG2 Large Format Interchangeable Core Cylinder - Includes master keying charges | \$135.00 |
| DG264 | Hardware prepared for DG2-6300 Lg. Format IC cores, supplied with temporary keyed construction cores | \$77.00 |
| DG3 | Patented Degree DG3 Key System incorporating a locking sidebar and UL437 listed | \$82.00/cyl. |
| DG360 | Hardware prepared for DG3-6300 Lg. Format IC cores, supplied with temporary plastic construction cores | No addition |
| DG363 | Patented Degree DG3 Large Format Interchangeable Core Cylinder - Includes master keying charges | \$159.00 |
| DG364 | Hardware prepared for DG3-6300 Lg. Format IC cores, supplied with temporary keyed construction cores | \$77.00 |
| IDP | Integrated Door Position Switch | \$100.00 |
| LB | Extra large thumbturn | \$16.00 |
| LC | Less Cylinder | -\$89.00/cyl. |
| OBS | Open Back Strike | \$73.00 |
| PHR | Deadbolt Privacy Function (available w/deadbolt function only) | \$100.00 |
| R01 | Mercury and Lenel compatible 1KΩ/2KΩ resistance supervision | \$100.00 |
| R03 | Software House compatible 1KΩ/2KΩ resistance supervision | \$100.00 |
| R04 | AMAG compatible 4-state supervision | \$100.00 |
| SC▲† | Schlage "C" Keyway cylinder, (Number 41 Cylinder Only, 0 bitted) | No addition |
| SE▲† | Schlage "E" Keyway cylinder, (Number 41 Cylinder Only, 0 bitted) | No addition |
| SG | MicroShield® – an antimicrobial powder coat finish | \$67.00 |
| WBS | Wrought Box Strike | No addition |

NOTES: ▲ Options not avail. with a standard 50 function lockout cylinder. † Not avail. with 60, 63, 64 options

| | | |
|-----|--|---------|
| CPC | Clear Powder Coat over 26D/32D – NAC-82280-24V x CEMD x RH x 32D x CPC All orders will continue to be handled as a "special" when CPC is ordered. | \$62.00 |
|-----|--|---------|

USA & Canada Prices Effective June 3, 2019



RMI

Collar: R
Lever: MI



RMO

Roseless Trim: R
Lever: MO

Lever Designs:

| Coastal† | Centro | Notting Hill | Aventura | Rialto | Odeon |
|----------|--------|--------------|----------|--------|-------|
| *G | MD | *MQ | MB | MO | *MH |
| R | MJ | *MM | ME | *MZ | *MS |
| *S | ND | *MY | MF | | *MU |
| *Y | NJ | | MG | | *MV |
| | | | MI | | *MX |
| | | | MW | | *NS |
| | | | NF | | *NU |

* Handed: specify hand when ordering

How to order: NAC-82284-12V x R MM x RH x 26D**

| | |
|----------|-------|
| Option | 21 |
| Function | R8205 |
| Rose | R** |
| Lever | MM |
| Hand | RH |
| Finish | 26D |

** Specify "R" for Mortise Locks compatible with roseless collar.

| NAC 8200 Electrified Mortise Locks with High Security Monitoring | | | | 10BE/26D/ BSP/WSP | 03/04/09/10/ 10B/10BL/14/15/ 20D/26†‡32†‡32D |
|--|-----------------|------------------------|--------------------------------------|----------------------|--|
| Option | Function | Trim - Proximity Entry | Description | | |
| NAC | R82270-12V/-24V | Rose x Lever Design | Fail Safe w/Cylinder Override | \$1,453.00 | \$1,477.00 |
| NAC | R82271-12V/-24V | Rose x Lever Design | Fail Secure w/Cylinder Override | | |
| NAC | R82280-12V/-24V | Rose x Lever Design | Fail Safe w/Deadbolt w/Cyl.Override | \$1,528.00 | \$1,552.00 |
| NAC | R82281-12V/-24V | Rose x Lever Design | Fail Secure w/D.bolt w/Cyl.Override | | |
| NAC | R82274-12V/-24V | Rose x Lever Design | Fail Safe - No Cylinder | \$1,398.00 | \$1,422.00 |
| NAC | R82275-12V/-24V | Rose x Lever Design | Fail Secure - No Cylinder | | |
| NAC | R82284-12V/-24V | Rose x Lever Design | Fail Safe w/Deadbolt - No Cylinder | \$1,473.00 | \$1,497.00 |
| NAC | R82285-12V/-24V | Rose x Lever Design | Fail Secure w/Deadbolt - No Cylinder | | |

Note: Consult catalog for ordering information.

* Specify hand and voltage (12v or 24v) when ordering.

† Coastal and MH, MM, MO, MQ, MS, MU, MV, MX, MY, MZ, NS, NU levers are not available in 32 and 32D finishes.

ML-80 MORTISE LOCKS

SARGENT®

ASSA ABLOY

OPTIONS

USA & Canada Prices Effective June 3, 2019

| Options | Description | Price |
|----------|---|--|
| 1▲ | 7800 Line with 1-1/16" wide front for 1-3/8" doors. | \$58.00 |
| 10▲ | SARGENT Signature Key System | \$58.00 / cyl. |
| 11†▲ | SARGENT XC Key System (not available with 10, 22, SC, SE options) | No addition |
| 1160 | SARGENT XC Large Format Interchangeable Plastic Disposable Construction Core | No addition |
| 1163 | SARGENT XC Large Format Interchangeable Core Cylinder - Includes masterkeying charges | \$77.00 |
| 1164 | SARGENT XC Large Format Interchangeable Construction Core Cylinder | 77 |
| 1170 | Small Format interchangeable disposable construction core - to accept 7 Pin XC permanent core | No addition |
| 11727P | Small Format interchangeable keyed construction core - to accept 7 Pin XC permanent core | \$69.00 |
| 11737P | Small Format interchangeable core - to accept 7 pin XC permanent core | \$69.00 / cyl. |
| 21▲† | SARGENT Construction Key System (lost ball) Standard on all new systems established since 5/1/96 | \$16.00 / cyl. |
| 22▲† | SARGENT Construction Key System (split key) To be used on pre-established split key systems only | \$32.00 / cyl. |
| 23 | Locksets with flat 4-7/8" ANSI strike | No addition |
| 31 | Thick Doors - Extended Lip Required - Specify Length C to E | |
| | - Cylinders - IMPORTANT- See catalog 7800/8200 option page for cylinder limitations | |
| | - Below charges DO NOT include additional charges for special cylinder requirements | |
| | Doors up to 2-1/2" thick - lock centered | No addition |
| | Doors 2-5/8" to 6" thick OR doors 1-3/4" thick w/max 1" paneling one side. | |
| | For example: Specify 1-3/4" door with panel (Side) on inside or outside | Non Keyed function \$50.00 Keyed function \$100.00 |
| 36 | 6 Lobe security head screws | \$23.00 |
| 37 | Spanner head screws | \$16.00 |
| 49 | Visual Status Indicator - Available with 30, 36, 37 function - Rose Trims 7800 CR, E, L, LN, O, TR | |
| | - Available with 26, 29, 38, 39 40, 41 functions - Rose Trim 8200 LN | \$92.00 |
| 49 | Occupancy Indicator with emergency Release - Available with 65, 66, 68 functions; Rose Trims 7800 CR, E, L, LN, O, TR | \$92.00 |
| 50* | Secured Indicator Rose- doors 1-5/8" to 2-1/4" thick- Avail.w/24,25,26,28,29,30,36,37,38,39,40,41,43,45,50,51,52,57,58,67 functions | \$62.00 |
| 60 | SARGENT Large Format Interchangeable Plastic Disposable Construction Core | No addition |
| 63 | SARGENT Large Format Interchangeable core cylinder, includes master keying charges | \$77.00 / cyl. |
| 64 | SARGENT Large Format Interchangeable Construction Core Cylinder | \$77.00 |
| 6573▲† | Small Format 6-Pin Uncombined Core (Refer to CK-12) | \$59.00 / cyl. |
| 65737P▲† | Small Format 7-Pin Uncombined Core (Refer to CK-12) | \$59.00 / cyl. |
| 68 | 8200 Line furnished with lever handle outside x knob inside (Excludes SLD Detention Knob) | Defaults to 8200 Lever Lock Price |
| 69 | 8200 Line furnished with lever handle inside x knob outside (Excludes SLD Detention Knob) | Defaults to 8200 Lever Lock Price |
| 70▲† | Small Format Interchangeable disposable plastic construction core | No addition |
| 72▲† | Small Format Interchangeable 6-pin construction core (7-pin with 11 option) | \$69.00 |
| 73▲† | Small Format interchangeable core 6-pin Includes MK and GMK keying charges | \$69.00 / cyl |
| 737P▲† | Small Format interchangeable core 7-pin (refer to CK-12 for available keyways) Includes MK and GMK keying charges | \$69.00 / cyl |
| 74 | Lock case wrapped in lead - handing required (roses not available) | \$272.00 |
| 75 | Tactile Warning - Milled Inside Knob | \$72.00 |
| 76 | Tactile Warning - Milled Outside Knob | \$72.00 |
| 77 | Tactile Warning - Milled Outside and Inside Knob | \$144.00 |
| 81▲† | Cylinder to accept Keso (83) and Keso F1 (F183) removable core - no core provided | No addition |
| F182† | SARGENT Keso Security Cylinder - patented - new key systems | \$84.00 / cyl. |
| F183▲† | SARGENT Keso Security Removable Core Cylinder - patented - new key systems | \$120.00 / cyl. |
| 82† | SARGENT Keso Security Cylinder (For existing systems only) | \$84.00 / cyl. |
| 83▲† | SARGENT Keso Security Removable Core Cylinder (For existing systems only) | \$120.00 / cyl. |
| 84▲† | SARGENT Keso Security Removable Construction Core Cylinder | See CK-18 |
| 85 | Tactile Warning - Abrasive Coating on Inside Knob | \$45.00 |
| 86 | Tactile Warning - Abrasive Coating on Outside Knob | \$45.00 |
| 87 | Tactile Warning - Abrasive Coating on Outside & Inside Knob | \$90.00 |
| AV | Anti Vandal Pull Trim (available in 32D finish) | \$212.00 |
| BR | SARGENT Bump Resistant Cylinders (N/A w/10, 22, 30, 60, 63, 64, 70, 72, 73, 737P, KESO, SC, & SE options) | \$23.00 / cyl. |
| DG1 | Patented Degree DG1 Key System | No Addition |
| DG160 | Hardware prepared for DG1-6300 Lg. Format IC cores, supplied with temporary plastic construction cores | No addition |
| DG163 | Patented Degree DG1 Large Format Interchangeable Core Cylinder - Includes master keying charges | \$77.00 |
| DG164 | Hardware prepared for DG1-6300 Lg. Format IC cores, supplied with temporary keyed construction cores | \$77.00 |
| DG2 | Patented Degree DG2 Key System incorporating a locking sidebar | \$58.00/cyl. |
| DG260 | Hardware prepared for DG2-6300 Lg. Format IC cores, supplied with temporary plastic construction cores | No addition |
| DG263 | Patented Degree DG2 Large Format Interchangeable Core Cylinder - Includes master keying charges | \$135.00 |
| DG264 | Hardware prepared for DG2-6300 Lg. Format IC cores, supplied with temporary keyed construction cores | \$77.00 |
| DG3 | Patented Degree DG3 Key System incorporating a locking sidebar and UL437 listed | \$82.00/cyl. |
| DG360 | Hardware prepared for DG3-6300 Lg. Format IC cores, supplied with temporary plastic construction cores | No addition |
| DG363 | Patented Degree DG3 Large Format Interchangeable Core Cylinder - Includes master keying charges | \$159.00 |
| DG364 | Hardware prepared for DG3-6300 Lg. Format IC cores, supplied with temporary keyed construction cores | \$77.00 |
| DX | Deadbolt Monitoring (not available with 50, 74) | \$182.00 |
| LC | Less Cylinder | -\$89.00/cyl. |
| OBS | Open Back Strike | \$73.00 |
| SC▲† | Schlage "C" Keyway cylinder, (Number 41 Cylinder Only, 0-bitted) | No addition |
| SE▲† | Schlage "E" Keyway cylinder, (Number 41 Cylinder Only, 0-bitted) | No addition |
| SG | MicroShield® - an antimicrobial powder coat finish | \$67.00 |
| WBS | Wrought Box Strike | No addition |

NOTES: ▲ Options not available with a standard 50 function lockout cylinder. † Not available with 60, 63, 64 options.

| | | |
|-----|--|---------|
| CPC | Clear Powder Coat over 26D/32D - 7805 x OB x 32D x CPC All orders will continue to be handled as a "special" when CPC is ordered. | \$62.00 |
|-----|--|---------|

USA & Canada Prices Effective June 3, 2019



OB
O, E, L, Rose • B-C Knob

| Function | | Finish | |
|---------------------------------|------------------------------------|------------------|--|
| | | 10BE/26D/BSP/WSP | 03/04/09/10/10B/10BL/14/15/20D/26/32/32D |
| Single Cyl | | | |
| 7804 | Storeroom or Closet | | |
| 7805 | Office or Entry | \$1,009.00 | \$1,033.00 |
| 7837 | Classroom | | |
| 7855 | Office or Entry | | |
| 7806 | Storeroom or Service | | |
| 7831 | Utility | | |
| 7836 | Closet | \$1,035.00 | \$1,059.00 |
| 7856 | Office or Inner Entry | | |
| 7857, 7858, 7867 | Institutional Privacy | | |
| Single Cyl With Deadbolt | | | |
| 7824 | Room Door | | |
| 7825 | Dormitory or Exit | | |
| 7827 | Closet or Storeroom | | |
| 7828, 7830 | Dummy Trim Deadlock | \$1,062.00 | \$1,086.00 |
| 7835 | Storeroom | | |
| 7843 | Apartment Corridor | | |
| 7845 | Dormitory or Exit | | |
| 7847 | Front Door or Apartment Corridor | | |
| 7851 | Storeroom Deadbolt | | |
| 7850 | Hotel Guest Lock | \$1,099.00 | \$1,123.00 |
| Double Cyl No Deadbolt | | | |
| 7816 | Apartment or Exit or Public Toilet | | |
| 7817 | Asylum or Institutional | \$1,115.00 | \$1,139.00 |
| 7838 | Classroom Security Intruder | | |
| Double Cyl With Deadbolt | | | |
| 7826 | Store Door | | |
| 7829 | Dummy Trim Deadlock | | |
| 7839, 7840 | Classroom Security Intruder | \$1,137.00 | \$1,161.00 |
| 7841 | Classroom Security | | |
| 7846 | Dormitory or Exit | | |
| 7848 | Store Door | | |
| 7852 | Institutional | | |
| Non Keyed | | | |
| 7813 | Communication or Exit | \$839.00 | \$863.00 |
| 7815 | Passage or Closet | | |
| 7865 | Privacy Bedroom or Bath (Latch) | \$951.00 | \$975.00 |
| 7866, 7868 | Privacy Bedroom or Bath (Deadbolt) | \$987.00 | \$1,011.00 |
| 7893 | Single Dummy Trim | \$328.00 | \$340.00 |
| 7894 | Double Dummy Trim | \$652.00 | \$676.00 |
| 7895 | Single Dummy Trim w/Lockbody | \$423.00 | \$435.00 |
| 7896 | Double Dummy Trim w/Lockbody | \$756.00 | \$780.00 |
| 7897 | Double Dummy w/Active Trim | \$839.00 | \$863.00 |

ML-82 MORTISE LOCKS

SARGENT®

ASSA ABLOY

OPTIONS

USA & Canada Prices Effective June 3, 2019

| Options | Description | Price |
|----------|---|---|
| 1▲ | 7800 Line with 1-1/16" wide front for 1-3/8" doors. | \$58.00 |
| 10▲ | SARGENT Signature Key System | \$58.00 / cyl. |
| 11†▲ | SARGENT XC Key System (not available with 10, 22, SC, SE options) | No addition |
| 1160 | SARGENT XC Large Format Interchangeable Plastic Disposable Construction Core | No addition |
| 1163 | SARGENT XC Large Format Interchangeable Core Cylinder - Includes masterkeying charges | \$77.00 |
| 1164 | SARGENT XC Large Format Interchangeable Construction Core Cylinder | \$77.00 |
| 1170 | Small Format interchangeable disposable construction core - to accept 7 Pin XC permanent core | No addition |
| 11727P | Small Format interchangeable keyed construction core - to accept 7 Pin XC permanent core | \$69.00 |
| 11737P | Small Format interchangeable core - to accept 7 pin XC permanent core | \$69.00 /cyl. |
| 21▲† | SARGENT Construction Key System (lost ball) Standard on all new systems established since 5/1/96 | \$16.00 / cyl. |
| 22▲† | SARGENT Construction Key System (split key) To be used on pre-established split key systems only | \$32.00 / cyl. |
| 31 | Thick Doors - Extended Lip Required - Specify Length C to E - Cylinders - IMPORTANT- See catalog 7800/8200 option page for cylinder limitations - Below charges DO NOT include additional charges for special cylinder requirements | No addition |
| | Doors up to 2-1/2" thick - lock centered | No addition |
| | Doors 2-5/8" to 6" thick OR doors 1-3/4" thick w/max 1" paneling one side. For example: Specify 1-3/4" door with panel (Side) on inside or outside | Non Keyed function \$50.00 Keyed function \$100.00 |
| 36 | 6 Lobe security head screws | \$23.00 |
| 37 | Spanner head screws | \$16.00 |
| 60 | SARGENT Large Format Interchangeable Plastic Disposable Construction Core | No addition |
| 63 | SARGENT Large Format Interchangeable core cylinder, includes master keying charges | \$77.00 / cyl. |
| 64 | SARGENT Large Format Interchangeable Construction Core Cylinder | \$77.00 |
| 6573▲† | Small Format 6-Pin Uncombined Core (Refer to CK-12) | \$59.00 / cyl. |
| 65737P▲† | Small Format 7-Pin Uncombined Core (Refer to CK-12) | \$59.00 / cyl. |
| 68 | 8200 Line furnished with lever handle outside x knob inside (Excludes SLD Detention Knob) | Defaults to 8200 Lever Lock Price |
| 69 | 8200 Line furnished with lever handle inside x knob outside (Excludes SLD Detention Knob) | Defaults to 8200 Lever Lock Price |
| 70▲† | Small Format Interchangeable disposable plastic construction core | No addition |
| 72▲† | Small Format Interchangeable 6-pin construction core (7-pin with 11 options) | \$69.00 |
| 73▲† | Small Format interchangeable core 6-pin Includes MK and GMK keying charges | \$69.00 / cyl |
| 737P▲† | Small Format interchangeable core 7-pin (refer to CK-12 for available keyways) Includes MK and GMK keying charges | \$69.00 / cyl |
| 75 | Tactile Warning - Milled Inside Knob | \$72.00 |
| 76 | Tactile Warning - Milled Outside Knob | \$72.00 |
| 77 | Tactile Warning - Milled Outside and Inside Knob | \$144.00 |
| 81▲† | Cylinder to accept Keso (83) and Keso F1 (F183) removable core – no core provided | No addition |
| F182† | SARGENT Keso Security Cylinder – patented – new key systems | \$84.00 / cyl. |
| F183▲† | SARGENT Keso Security Removable Core Cylinder – patented – new key systems | \$120.00 / cyl. |
| 82† | SARGENT Keso Security Cylinder (For existing systems only) | \$84.00 / cyl. |
| 83▲† | SARGENT Keso Security Removable Core Cylinder (For existing systems only) | \$120.00 / cyl. |
| 84▲† | SARGENT Keso Security Removable Construction Core Cylinder | See CK-18 |
| 85 | Tactile Warning - Abrasive Coating on Inside Knob | \$45.00 |
| 86 | Tactile Warning - Abrasive Coating on Outside Knob | \$45.00 |
| 87 | Tactile Warning - Abrasive Coating on Outside & Inside Knob | \$90.00 |
| AV | Anti Vandal Pull Trim (available in 32D finish) | \$212.00 |
| BR | SARGENT Bump Resistant Cylinders (N/A w/10, 22, 30, 60, 63, 64, 70, 72, 73, 737P, KESO, SC, & SE options) | \$23.00 /cyl. |
| DG1 | Patented Degree DG1 Key System | No Addition |
| DG160 | Hardware prepared for DG1-6300 Lg. Format IC cores, supplied with temporary plastic construction cores | No addition |
| DG163 | Patented Degree DG1 Large Format Interchangeable Core Cylinder - Includes master keying charges | \$77.00 |
| DG164 | Hardware prepared for DG1-6300 Lg. Format IC cores, supplied with temporary keyed construction cores | \$77.00 |
| DG2 | Patented Degree DG2 Key System incorporating a locking sidebar | \$58.00/cyl. |
| DG260 | Hardware prepared for DG2-6300 Lg. Format IC cores, supplied with temporary plastic construction cores | No addition |
| DG263 | Patented Degree DG2 Large Format Interchangeable Core Cylinder - Includes master keying charges | \$135.00 |
| DG264 | Hardware prepared for DG2-6300 Lg. Format IC cores, supplied with temporary keyed construction cores | \$77.00 |
| DG3 | Patented Degree DG3 Key System incorporating a locking sidebar and UL437 listed | \$82.00/cyl. |
| DG360 | Hardware prepared for DG3-6300 Lg. Format IC cores, supplied with temporary plastic construction cores | No addition |
| DG363 | Patented Degree DG3 Large Format Interchangeable Core Cylinder - Includes master keying charges | \$159.00 |
| DG364 | Hardware prepared for DG3-6300 Lg. Format IC cores, supplied with temporary keyed construction cores | \$77.00 |
| DX | Deadbolt Monitoring (not available with 50, 74) | \$182.00 |
| EMA* | "Lock" directional arrow engraving provided for outside KE1 escutcheon trim only | \$44.00 |
| EMB* | "Lock" directional arrow engraving provided for inside KE1 escutcheon trim only | \$44.00 |
| EMC* | "Lock" directional arrow engraving provided for both sides of KE1 escutcheon trim | \$88.00 |
| LC | Less Cylinder | -\$89.00/cyl. |
| OBS | Open Back Strike | \$73.00 |
| SC▲† | Schlage "C" Keyway cylinder, (Number 41 Cylinder Only, 0 bitted) | No addition |
| SE▲† | Schlage "E" Keyway cylinder, (Number 41 Cylinder Only, 0 bitted) | No addition |
| SG | MicroShield® – an antimicrobial powder coat finish | \$67.00 |
| VNA | Status indicator provided for the outside KE1 escutcheon trim only | \$92.00 |
| VNB | Status indicator provided for the inside KE1 escutcheon trim only | \$92.00 |
| VNC | Status indicators provided for both sides of KE1 escutcheon trim | \$184.00 |
| WBS | Wrought Box Strike | No addition |

NOTES: ▲ Options not available with a standard 50 function lockout cylinder. † Not available with 60, 63, 64 options.

| | | |
|-----|---|---------|
| CPC | Clear Powder Coat over 26D/32D – 7805 x KW1B x RH x 32D x CPC All orders will continue to be handled as a "special" when CPC is ordered. | \$62.00 |
|-----|---|---------|

KW1 Escutcheon
B-C Knob



KE1 Escutcheon
B-C Knob
Prices shown



KE2, KE3, KE4
Escutcheons
– refer to ML-40 for add

KW1B

KE1B

| Single Cyl | | Finish | | Finish | |
|---------------------------------|------------------------------------|---------------------|---|---------------------------------------|---|
| | | 10BE/26D BSP/WSP | 03/04/09/10/10B/10BL 14/15/20D/26/32/32D | 10BE/26D BSP/WSP | 03/04/09/10/10B/10BL 14/15/20D/26/32/32D |
| 7804 | Storeroom or Closet | | | | |
| 7805 | Office or Entry | \$1,112.00 | \$1,136.00 | \$1,215.00 | \$1,239.00 |
| 7837 | Classroom | | | | |
| 7855 | Office or Entry | | | | |
| 7806 | Storeroom or Service | | | | |
| 7831 | Utility | | | | |
| 7836 | Closet | \$1,133.00 | \$1,157.00 | \$1,241.00 | \$1,265.00 |
| 7856 | Office or Inner Entry | | | | |
| 7857, 7858, 7867 | Institutional Privacy | | | | |
| Single Cyl With Deadbolt | | | | | |
| 7824 | Room Door | | | | |
| 7825 | Dormitory or Exit | | | | |
| 7827 | Closet or Storeroom | | | | |
| 7828, 7830 | Dummy Trim Deadlock | | | | |
| 7835 | Storeroom | \$1,166.00 | \$1,190.00 | \$1,267.00 | \$1,291.00 |
| 7843 | Apartment Corridor | | | | |
| 7845 | Dormitory or Exit | | | | |
| 7847 | Front Door or Apartment Corridor | | | | |
| 7851 | Storeroom Deadbolt | | | | |
| 7850 | Hotel Guest Lock | \$1,202.00 | \$1,226.00 | \$1,306.00 | \$1,330.00 |
| Double Cyl No Deadbolt | | | | | |
| 7816 | Apartment or Exit or Public Toilet | | | NOT AVAILABLE IN KE3 & KE4 | |
| 7817 | Asylum or Institutional | \$1,215.00 | \$1,239.00 | \$1,320.00 | \$1,344.00 |
| 7838 | Classroom Security Intruder | | | | |
| Double Cyl With Deadbolt | | | | | |
| 7826 | Store Door | | | NOT AVAILABLE IN KE3 & KE4 | |
| 7829 | Dummy Trim Deadlock | | | | |
| 7839, 7840 | Classroom Security Intruder | \$1,241.00 | \$1,265.00 | \$1,346.00 | \$1,370.00 |
| 7841 | Classroom Security | | | | |
| 7846 | Dormitory or Exit | | | | |
| 7848 | Store Door | | | | |
| 7852 | Institutional | | | | |
| Non Keyed | | | | | |
| 7813 | Communication or Exit | \$938.00 | \$962.00 | \$1,043.00 | \$1,067.00 |
| 7815 | Passage or Closet | | | | |
| 7865 | Privacy Bedroom or Bath (Latch) | \$1,048.00 | \$1,072.00 | \$1,154.00 | \$1,178.00 |
| 7866, 7868 | Privacy Bedroom or Bath (Deadbolt) | \$1,088.00 | \$1,112.00 | \$1,192.00 | \$1,216.00 |
| 7893 | Single Dummy Trim | \$375.00 | \$387.00 | \$431.00 | \$443.00 |
| 7894 | Double Dummy Trim | \$756.00 | \$780.00 | \$857.00 | \$881.00 |
| 7895 | Single Dummy Trim w/Lockbody | \$478.00 | \$490.00 | \$530.00 | \$542.00 |
| 7896 | Double Dummy Trim w/Lockbody | \$853.00 | \$877.00 | \$957.00 | \$981.00 |
| 7897 | Double Dummy w/Active Trim | \$938.00 | \$962.00 | \$1,043.00 | \$1,067.00 |

Escutcheon Variations

| | | | |
|----------------------|-----|--|-------------|
| Standard Cylinder | KE2 | x concealed mounting | \$29.00 |
| Non-Keyed Function | KE2 | x concealed mounting | \$29.00 |
| Cylinder Barrel Only | KE3 | x exposed screws (not avail. in double cyl. functions) | \$82.00 Set |
| Non-Keyed Function | KE3 | x exposed screws | \$29.00 |
| Cylinder Barrel Only | KE4 | x concealed mounting (not avail. in double cyl. functions) | \$94.00 |
| Non-Keyed Function | KE4 | x concealed mounting | \$29.00 |

ML-84 MORTISE LOCKS

SARGENT®

ASSA ABLOY

OPTIONS

USA & Canada Prices Effective June 3, 2019

| Options | Description | Price |
|----------|--|--|
| 1▲ | 7800 Line with 1-1/16" wide front for 1-3/8" doors. | \$58.00 |
| 10▲ | SARGENT Signature Key System | \$58.00 / cyl. |
| 11† ▲ | SARGENT XC Key System (not available with 10, 22, SC, SE options) | No addition |
| 1160 | SARGENT XC Large Format Interchangeable Plastic Disposable Construction Core | No addition |
| 1163 | SARGENT XC Large Format Interchangeable Core Cylinder - Includes masterkeying charges | \$77.00 |
| 1164 | SARGENT XC Large Format Interchangeable Construction Core Cylinder | \$77.00 |
| 1170 | Small Format interchangeable disposable construction core - to accept 7 Pin XC permanent core | No addition |
| 11727P | Small Format interchangeable keyed construction core - to accept 7 Pin XC permanent core | \$69.00 |
| 11737P | Small Format interchangeable core - to accept 7 pin XC permanent core | \$69.00 / cyl. |
| 21▲† | SARGENT Construction Key System (lost ball) Standard on all new systems established since 5/1/96 | \$16.00 / cyl. |
| 22▲† | SARGENT Construction Key System (split key) To be used on pre-established split key systems only | \$32.00 / cyl. |
| 23 | Locksets with flat 4-7/8" ANSI strike | No addition |
| 31 | Thick Doors - Extended Lip Required - Specify Length C to E - Cylinders - IMPORTANT- See catalog 7800/8200 option page for cylinder limitations - Below charges DO NOT include additional charges for special cylinder requirements Doors up to 2-1/2" thick - lock centered Doors 2-5/8" to 6" thick OR doors 1-3/4" thick w/max 1" paneling one side. For example: Specify 1-3/4" door with panel (Side) on inside or outside | No addition Non Keyed function \$50.00 Keyed function \$100.00 |
| 36 | 6 Lobe security head screws | \$23.00 |
| 37 | Spanner head screws | \$16.00 |
| 60 | SARGENT Large Format Interchangeable Plastic Disposable Construction Core | No addition |
| 63 | SARGENT Large Format Interchangeable core cylinder, includes master keying charges | \$77.00 / cyl. |
| 64 | SARGENT Large Format Interchangeable Construction Core Cylinder | \$77.00 |
| 6573▲† | Small Format 6-Pin Uncombined Core (Refer to CK-12) | \$59.00 / cyl. |
| 65737P▲† | Small Format 7-Pin Uncombined Core (Refer to CK-12) | \$59.00 / cyl. |
| 68 | 8200 Line furnished with lever handle outside x knob inside (Excludes SLD Detention Knob) | Defaults to 8200 Lever Lock Price |
| 69 | 8200 Line furnished with lever handle inside x knob outside (Excludes SLD Detention Knob) | Defaults to 8200 Lever Lock Price |
| 70▲† | Small Format Interchangeable disposable plastic construction core | No addition |
| 72▲† | Small Format Interchangeable 6-pin construction core (7-pin with 11 options) | \$69.00 |
| 73▲† | Small Format interchangeable core 6-pin Includes MK and GMK keying charges | \$69.00 / cyl |
| 737P▲† | Small Format interchangeable core 7-pin (refer to CK-12 for available keyways) Includes MK and GMK keying charges | \$69.00 / cyl |
| 75 | Tactile Warning - Milled Inside Knob | \$72.00 |
| 76 | Tactile Warning - Milled Outside Knob | \$72.00 |
| 77 | Tactile Warning - Milled Outside and Inside Knob | \$144.00 |
| 81▲† | Cylinder to accept Keso (83) and Keso F1 (F183) removable core – no core provided | No addition |
| F182† | SARGENT Keso Security Cylinder – patented – new key systems | \$84.00 / cyl. |
| F183▲† | SARGENT Keso Security Removable Core Cylinder – patented – new key systems | \$120.00 / cyl. |
| 82† | SARGENT Keso Security Cylinder (For existing systems only) | \$84.00 / cyl. |
| 83▲† | SARGENT Keso Security Removable Core Cylinder (For existing systems only) | \$120.00 / cyl. |
| 84▲† | SARGENT Keso Security Removable Construction Core Cylinder | See CK-18 |
| 85 | Tactile Warning - Abrasive Coating on Inside Knob | \$45.00 |
| 86 | Tactile Warning - Abrasive Coating on Outside Knob | \$45.00 |
| 87 | Tactile Warning - Abrasive Coating on Outside & Inside Knob | \$90.00 |
| AV | Anti Vandal Pull Trim (available in 32D finish) | \$212.00 |
| BR | SARGENT Bump Resistant Cylinders (N/A w/10, 22, 30, 60, 63, 64, 70, 72, 73, 737P, KESO, SC, & SE options) | \$23.00 /cyl. |
| DG1 | Patented Degree DG1 Key System | No Addition |
| DG160 | Hardware prepared for DG1-6300 Lg. Format IC cores, supplied with temporary plastic construction cores | No addition |
| DG163 | Patented Degree DG1 Large Format Interchangeable Core Cylinder - Includes master keying charges | \$77.00 |
| DG164 | Hardware prepared for DG1-6300 Lg. Format IC cores, supplied with temporary keyed construction cores | \$77.00 |
| DG2 | Patented Degree DG2 Key System incorporating a locking sidebar | \$58.00/cyl. |
| DG260 | Hardware prepared for DG2-6300 Lg. Format IC cores, supplied with temporary plastic construction cores | No addition |
| DG263 | Patented Degree DG2 Large Format Interchangeable Core Cylinder - Includes master keying charges | \$135.00 |
| DG264 | Hardware prepared for DG2-6300 Lg. Format IC cores, supplied with temporary keyed construction cores | \$77.00 |
| DG3 | Patented Degree DG3 Key System incorporating a locking sidebar and UL437 listed | \$82.00/cyl. |
| DG360 | Hardware prepared for DG3-6300 Lg. Format IC cores, supplied with temporary plastic construction cores | No addition |
| DG363 | Patented Degree DG3 Large Format Interchangeable Core Cylinder - Includes master keying charges | \$159.00 |
| DG364 | Hardware prepared for DG3-6300 Lg. Format IC cores, supplied with temporary keyed construction cores | \$77.00 |
| DX | Deadbolt Monitoring (not available with 50, 74) | \$182.00 |
| LC | Less Cylinder | -\$89.00/cyl. |
| OBS | Open Back Strike | \$73.00 |
| SC▲† | Schlage "C" Keyway cylinder, (Number 41 Cylinder Only, 0-bitted) | No addition |
| SE▲† | Schlage "E" Keyway cylinder, (Number 41 Cylinder Only, 0-bitted) | No addition |
| SG | MicroShield® – an antimicrobial powder coat finish | \$67.00 |
| WBS | Wrought Box Strike | No addition |

NOTES: ▲ Options not available with a standard 50 function lockout cylinder. † Not available with 60, 63, 64 options.

| | | |
|-----|--|---------|
| CPC | Clear Powder Coat over 26D/32D – 7805 x WTB x RH x 32D x CPC All orders will continue to be handled as a "special" when CPC is ordered. | \$62.00 |
|-----|--|---------|

USA & Canada Prices Effective June 3, 2019



WTB
WT Escutcheon • B-C Knob

| Function | | Finish | |
|---------------------------------|------------------------------------|------------------|--|
| Single Cyl | | 10BE/26D/BSP/WSP | 03/04/09/10/10B/10BL/14/15/20D/26/32/32D |
| 7804 | Storeroom or Closet | | |
| 7805 | Office or Entry | \$1,048.00 | \$1,072.00 |
| 7837 | Classroom | | |
| 7855 | Office or Entry | | |
| 7806 | Storeroom or Service | | |
| 7831 | Utility | | |
| 7836 | Closet | \$1,070.00 | \$1,094.00 |
| 7856 | Office or Inner Entry | | |
| 7857, 7858, 7867 | Institutional Privacy | | |
| Single Cyl With Deadbolt | | | |
| 7824 | Room Door | | |
| 7825 | Dormitory or Exit | | |
| 7827 | Closet or Storeroom | | |
| 7828, 7830 | Dummy Trim Deadlock | | |
| 7835 | Storeroom | \$1,099.00 | \$1,123.00 |
| 7843 | Apartment Corridor | | |
| 7845 | Dormitory or Exit | | |
| 7847 | Front Door or Apartment Corridor | | |
| 7851 | Storeroom Deadbolt | | |
| 7850 | Hotel Guest Lock | \$1,137.00 | \$1,161.00 |
| Double Cyl No Deadbolt | | | |
| 7816 | Apartment or Exit or Public Toilet | | |
| 7817 | Asylum or Institutional | \$1,154.00 | \$1,178.00 |
| 7838 | Classroom Security Intruder | | |
| Double Cyl With Deadbolt | | | |
| 7826 | Store Door | | |
| 7829 | Dummy Trim Deadlock | | |
| 7839, 7840 | Classroom Security Intruder | | |
| 7841 | Classroom Security | \$1,178.00 | \$1,202.00 |
| 7846 | Dormitory or Exit | | |
| 7848 | Store Door | | |
| 7852 | Institutional | | |
| Non Keyed | | | |
| 7813 | Communication or Exit | \$879.00 | \$903.00 |
| 7815 | Passage or Closet | | |
| 7865 | Privacy Bedroom or Bath (Latch) | \$987.00 | \$1,011.00 |
| 7866, 7868 | Privacy Bedroom or Bath (Deadbolt) | \$1,030.00 | \$1,054.00 |
| 7893 | Single Dummy Trim | \$346.00 | \$358.00 |
| 7894 | Double Dummy Trim | \$695.00 | \$719.00 |
| 7895 | Single Dummy Trim w/Lockbody | \$445.00 | \$457.00 |
| 7896 | Double Dummy Trim w/Lockbody | \$790.00 | \$814.00 |
| 7897 | Double Dummy w/Active Trim | \$879.00 | \$903.00 |

ML-86 MORTISE LOCKS

SARGENT®

ASSA ABLOY

OPTIONS

USA & Canada Prices Effective June 3, 2019

| Options | Description | Price |
|---------|--|----------------|
| 10▲ | SARGENT Signature Key System | \$58.00 / cyl. |
| 11▲ | SARGENT XC Key System (not available with 10, 22, SC, SE options) | No addition |
| 21▲ | SARGENT Construction Key System (lost ball) | \$16.00 / cyl. |
| 22▲ | SARGENT Construction Key System (split key) | \$32.00 / cyl. |
| 23 | Locksets with flat 4-7/8" ANSI strike | No addition |
| 31 | Thick Doors - Extended Lip Required - Specify Length C to E - Cylinders - IMPORTANT- See catalog 7800/8200 option page for cylinder limitations - Below charges DO NOT include additional charges for special cylinder requirements Doors up to 2-1/2" thick - lock centered Doors 2-5/8" to 6" thick OR doors 1-3/4" thick w/max 1" paneling one side. For example: Specify 1-3/4" door with panel (Side) on inside or outside | No addition |
| | Non Keyed function \$50.00 Keyed function \$100.00 | |
| 36 | 6 Lobe security head screws | \$23.00 |
| 37 | Spanner head screws | \$16.00 |
| F182▲ | SARGENT Keso Security Cylinder – patented – new key systems | \$84.00 / cyl. |
| 82▲ | SARGENT Keso Security Cylinder (For existing systems only) | \$84.00 / cyl. |
| 85 | Tactile Warning - Abrasive Coating on Inside Knob | \$45.00 |
| 86 | Tactile Warning - Abrasive Coating on Outside Knob | \$45.00 |
| 87 | Tactile Warning - Abrasive Coating on Outside & Inside Knob | \$90.00 |
| BR | SARGENT Bump Resistant Cylinders (N/A w/10, 22, 30, 60, 63, 64, 70, 72, 73, 737P, KESO, SC, & SE options) | \$23.00 /cyl. |
| LC | Less Cylinder | -\$89.00/cyl. |
| OBS | Open Back Strike | \$73.00 |
| SC▲ | Schlage C Keyway Cylinder, (Number 41 Cylinder Only, 0 bitted) | No addition |
| SE▲ | Schlage E Keyway Cylinder, (Number 41 Cylinder Only, 0 bitted) | No addition |
| SG | MicroShield® – an antimicrobial powder coat finish | \$67.00 |
| WBS | Wrought Box Strike | No addition |

NOTES: ▲ Options not available with a standard 50 function lockout cylinder.

| | | |
|-----|--|---------|
| CPC | Clear Powder Coat over 26D/32D – 7805 x KSK x RH x 32D x CPC All orders will continue to be handled as a "special" when CPC is ordered. | \$62.00 |
|-----|--|---------|



KSK
KS Escutcheon
K Knob (1485)

USA & Canada Prices Effective June 3, 2019

| Function | | Finish | |
|---------------------------------|------------------------------------|------------------|------------------------------|
| Single Cyl | | 10BE/26D/BSP/WSP | 03/04/09/10B/14/15/26/32/32D |
| 7804 | Storeroom or Closet | | |
| 7805 | Office or Entry | | |
| 7837 | Classroom | \$1,769.00 | \$1,793.00 |
| 7855 | Office or Entry | | |
| 7806 | Storeroom or Service | | |
| 7831 | Utility | \$1,797.00 | \$1,821.00 |
| 7836 | Closet | | |
| Single Cyl With Deadbolt | | | |
| 7824 | Room Door | | |
| 7825 | Dormitory or Exit | | |
| 7835 | Storeroom | \$1,830.00 | \$1,854.00 |
| 7843 | Apartment Corridor | | |
| 7845 | Dormitory or Exit | | |
| 7850 | Hotel Guest Lock | \$1,865.00 | \$1,889.00 |
| Double Cyl No Deadbolt | | | |
| 7816 | Apartment or Exit or Public Toilet | | |
| 7817 | Asylum or Institutional | \$1,881.00 | \$1,905.00 |
| 7838 | Classroom Security Intruder | | |
| Double Cyl With Deadbolt | | | |
| 7826 | Store Door | | |
| 7839, 7840 | Classroom Security Intruder | \$1,902.00 | \$1,926.00 |
| 7841 | Classroom Security | | |
| 7852 | Institutional | | |
| Non Keyed | | | |
| 7813 | Communication or Exit | \$1,598.00 | \$1,622.00 |
| 7815 | Passage or Closet | | |
| 7865 | Privacy Bedroom or Bath (Latch) | \$1,710.00 | \$1,734.00 |
| 7866 | Privacy Bedroom or Bath (Deadbolt) | \$1,748.00 | \$1,772.00 |

NOTES

Available with size #41 cylinder only. Cylinder lip sits behind escutcheon.

ML-88 MORTISE LOCKS

SARGENT®

ASSA ABLOY

OPTIONS

USA & Canada Prices Effective June 3, 2019

| Options | Description | Price |
|----------|--|---|
| 1▲ | 7800 Line with 1-1/16" wide front for 1-3/8" doors. | \$58.00 |
| 10▲ | SARGENT Signature Key System | \$58.00 / cyl. |
| 11†▲ | SARGENT XC Key System (not available with 10, 22, SC, SE options) | No addition |
| 1160 | SARGENT XC Large Format Interchangeable Plastic Disposable Construction Core | No addition |
| 1163 | SARGENT XC Large Format Interchangeable Core Cylinder - Includes masterkeying charges | \$77.00 |
| 1164 | SARGENT XC Large Format Interchangeable Construction Core Cylinder | \$77.00 |
| 1170 | Small Format interchangeable disposable construction core - to accept 7 Pin XC permanent core | No addition |
| 11727P | Small Format interchangeable keyed construction core - to accept 7 Pin XC permanent core | \$69.00 |
| 11737P | Small Format interchangeable core - to accept 7 pin XC permanent core | \$69.00 / cyl. |
| 21▲† | SARGENT Construction Key System (lost ball) Standard on all new systems established since 5/1/96 | \$16.00 / cyl. |
| 22▲† | SARGENT Construction Key System (split key) To be used on pre-established split key systems only | \$32.00 / cyl. |
| 23 | Locksets with flat 4-7/8" ANSI strike | No addition |
| 31 | Thick Doors - Extended Lip Required - Specify Length C to E - Cylinders - IMPORTANT- See catalog 7800/8200 option page for cylinder limitations - Below charges DO NOT include additional charges for special cylinder requirements Doors up to 2-1/2" thick - lock centered Doors 2-5/8" to 6" thick OR doors 1-3/4" thick w/max 1" paneling one side. For example: Specify 1-3/4" door with panel (Side) on inside or outside | No addition Non Keyed function \$50.00 Keyed function \$100.00 |
| 36 | 6 Lobe security head screws | \$23.00 |
| 37 | Spanner head screws | \$16.00 |
| 60 | SARGENT Large Format Interchangeable Plastic Disposable Construction Core | No addition |
| 63 | SARGENT Large Format Interchangeable core cylinder, includes master keying charges | \$77.00 / cyl. |
| 64 | SARGENT Large Format Interchangeable Construction Core Cylinder | \$77.00 |
| 6573▲† | Small Format 6-Pin Uncombined Core (Refer to CK-12) | \$59.00 / cyl. |
| 65737P▲† | Small Format 7-Pin Uncombined Core (Refer to CK-12) | \$59.00 / cyl. |
| 70▲† | Small Format Interchangeable disposable plastic construction core | No addition |
| 72▲† | Small Format Interchangeable 6-pin construction core (7-pin with 11 option) | \$69.00 |
| 73▲† | Small Format interchangeable core 6-pin Includes MK and GMK keying charges | \$69.00 / cyl |
| 737P▲† | Small Format interchangeable core 7-pin (refer to CK-12 for available keyways) Includes MK and GMK keying charges | \$69.00 / cyl |
| 74 | Lock case wrapped in lead – handing required (roses not available) | \$272.00 |
| 81▲† | Cylinder to accept Keso (83) and Keso F1 (F183) removable core – no core provided | No addition |
| F182† | SARGENT Keso Security Cylinder – patented – new key systems | \$84.00 / cyl. |
| F183▲† | SARGENT Keso Security Removable Core Cylinder – patented – new key systems | \$120.00 / cyl. |
| 82† | SARGENT Keso Security Cylinder (For existing systems only) | \$84.00 / cyl. |
| 83▲† | SARGENT Keso Security Removable Core Cylinder (For existing systems only) | \$120.00 / cyl. |
| 84▲† | SARGENT Keso Security Removable Construction Core Cylinder | See CK-18 |
| AV | Anti Vandal Pull Trim (available in 32D finish) | \$212.00 |
| BR | SARGENT Bump Resistant Cylinders (N/A w/10, 22, 30, 60, 63, 64, 70, 72, 73, 737P, KESO, SC, & SE options) | \$23.00 /cyl. |
| DG1 | Patented Degree DG1 Key System | No Addition |
| DG160 | Hardware prepared for DG1-6300 Lg. Format IC cores, supplied with temporary plastic construction cores | No addition |
| DG163 | Patented Degree DG1 Large Format Interchangeable Core Cylinder - Includes master keying charges | \$77.00 |
| DG164 | Hardware prepared for DG1-6300 Lg. Format IC cores, supplied with temporary keyed construction cores | \$77.00 |
| DG2 | Patented Degree DG2 Key System incorporating a locking sidebar | \$58.00/cyl. |
| DG260 | Hardware prepared for DG2-6300 Lg. Format IC cores, supplied with temporary plastic construction cores | No addition |
| DG263 | Patented Degree DG2 Large Format Interchangeable Core Cylinder - Includes master keying charges | \$135.00 |
| DG264 | Hardware prepared for DG2-6300 Lg. Format IC cores, supplied with temporary keyed construction cores | \$77.00 |
| DG3 | Patented Degree DG3 Key System incorporating a locking sidebar and UL437 listed | \$82.00/cyl. |
| DG360 | Hardware prepared for DG3-6300 Lg. Format IC cores, supplied with temporary plastic construction cores | No addition |
| DG363 | Patented Degree DG3 Large Format Interchangeable Core Cylinder - Includes master keying charges | \$159.00 |
| DG364 | Hardware prepared for DG3-6300 Lg. Format IC cores, supplied with temporary keyed construction cores | \$77.00 |
| DX | Deadbolt Monitoring (not available with 50, 74) | \$182.00 |
| LC | Less Cylinder | -\$89.00/cyl. |
| OBS | Open Back Strike | \$73.00 |
| SC▲† | Schlage "C" Keyway cylinder, (Number 41 Cylinder Only, 0-bitted) | No Addition |
| SE▲† | Schlage "E" Keyway cylinder, (Number 41 Cylinder Only, 0-bitted) | No Addition |
| SG | MicroShield® – an antimicrobial powder coat finish | \$67.00 |
| WBS | Wrought Box Strike | No Addition |

NOTES: ▲ Options not available with a standard 50 function lockout cylinder. † Not available with 60, 63, 64 options.

| | | |
|-----|--|---------|
| CPC | Clear Powder Coat over 26D/32D – 7805 x SLD x RH x 32D x CPC All orders will continue to be handled as a "special" when CPC is ordered. | \$62.00 |
|-----|--|---------|

USA & Canada Prices Effective June 3, 2019



SLD
SL- Rose • D Knob

NOTE: Not ADA Compliant.

| Function | Finish |
|---|------------|
| Single Cyl | 32D |
| 7804 Storeroom or Closet | |
| 7805 Office or Entry | |
| 7837 Classroom | \$2,003.00 |
| 7855 Office or Entry | |
| 7806 Storeroom or Service | |
| 7831 Utility | |
| 7836 Closet | \$2,024.00 |
| 7856 Office or Inner Entry | |
| 7857, 7858, 7867 Institutional Privacy | |
| Single Cyl With Deadbolt | |
| 7824 Room Door | |
| 7825 Dormitory or Exit | |
| 7827 Closet or Storeroom | |
| 7828, 7830 Dummy Trim Deadlock | |
| 7835 Storeroom | \$2,050.00 |
| 7843 Apartment Corridor | |
| 7845 Dormitory or Exit | |
| 7847 Front Door or Apartment Corridor | |
| 7851 Storeroom Deadbolt | |
| 7850 Hotel Guest Lock | \$2,088.00 |
| Double Cyl No Deadbolt | |
| 7816 Apartment or Exit or Public Toilet | |
| 7817 Asylum or Institutional | \$2,097.00 |
| 7838 Classroom Security Intruder | |
| Double Cyl With Deadbolt | |
| 7826 Store Door | |
| 7829 Dummy Trim Deadlock | |
| 7839, 7840 Classroom Security Intruder | |
| 7841 Classroom Security | \$2,120.00 |
| 7846 Dormitory or Exit | |
| 7848 Store Door | |
| 7852 Institutional | |
| Non Keyed | |
| 7813 Communication or Exit | \$1,842.00 |
| 7815 Passage or Closet | |
| 7865 Privacy Bedroom or Bath (Latch) | \$1,946.00 |
| 7866, 7868 Privacy Bedroom or Bath (Deadbolt) | \$1,977.00 |
| 7893 Single Dummy Trim | \$833.00 |
| 7894 Double Dummy Trim | \$1,668.00 |
| 7895 Single Dummy Trim w/Lockbody | \$930.00 |
| 7896 Double Dummy Trim w/Lockbody | \$1,761.00 |
| 7897 Double Dummy w/Active Trim | \$1,842.00 |

ML-90 MORTISE LOCKS

SARGENT®

8200 DEADLOCKS

ASSA ABLOY

USA & Canada Prices Effective June 3, 2019



8200
Mortise Deadlock

| Function | | Finish | |
|--------------------------|----------------------|------------------|--|
| Single Cylinder Deadbolt | | 10BE/26D/BSP/WSP | 03/04/09/10/10B/10BL/14/15/20D/26/32/32D |
| 8203 | Cylinder x thumbturn | \$488.00 | \$491.00 |
| 8220 | Cylinder | \$423.00 | \$444.00 |
| 8221 | Cylinder x thumbturn | \$488.00 | \$510.00 |
| Double Cylinder Deadbolt | | | |
| 8222 | Cylinder | \$515.00 | \$532.00 |
| 8223 | Cylinder x thumbturn | \$580.00 | \$598.00 |

| Double Cylinder All-Purpose Lock with 126 T-Turn Inside | | Finish | |
|--|--|------------------|--|
| | | 10BE/26D/BSP/WSP | 03/04/09/10/10B/10BL/14/15/20D/26/32/32D |
| *7892 x SSTT | | \$851.00 | \$857.00 |

Options Available:

1, 10, 11, 21, 22, 23, 31, 36, 37, 51, 52, 60, 63, 64, 65-73, 65-73-7P,
70, 72, 73, 73-7P, 74, 81, F182, F183, 82, 83, 84, DX, LC, SC, SE, SG, WBS

Please note: not all options are compatible. refer to 7800/8200 catalog option page.

*Please note: 126 T-Turn (SSTT) is only available for use with 7892 function.

DISTRIBUTOR BULK PACK PROGRAM

USA & Canada Prices Effective June 3, 2019

Features of the SARGENT Distributor Bulk Pack Program

- Allows the distributor to virtually “build your own” SARGENT mortise locks by stocking bulk packed lock bodies, complete trim sets and cylinders separately for maximum utilization of warehouse space and inventory dollars
- The 3 components fit snugly in specially designed packaging for ease in picking and maximum protection
- List price of the components equals that of a complete mortise lock. Standard Buying Program discounts apply

Using the SARGENT Distributor Bulk Pack Program

- Lockbodies must be ordered in multiples of 10 per function/finish. Option BP- to lock function in order to receive bulk packaging and bulk pack program pricing. Strike and o/s front are included, please specify finish. The lock bodies are individually pack aged in with strike and o/s front in protective sleeves. Packed 10 per carton.
- Complete trim sets must be ordered in multiples of 10 per design/finish. These are individually packaged in full mortise lock boxes and are packed 10 per carton.
- Order cylinders as a separate line item if required.

Product functions available

| Function | Description | ANSI |
|-----------|----------------|------|
| 7804/8204 | Storeroom | F07 |
| 7805/8205 | Office | F04 |
| 7837/8237 | Classroom | F05 |
| 7824/8224 | Storeroom | F21 |
| 7825/8225 | Dormitory | F13 |
| 7843/8243 | Dwelling Entry | F20 |
| 7845/8245 | Dwelling Entry | F12 |
| 7815/8215 | Passage | F01 |
| 7865/8265 | Privacy | F22 |

Designs and Finishes Available

ALL current 7800/8200 trim designs and finishes will be offered within the SARGENT Distributor Bulk Pack.

How to Order/Notes: Example: BP-8225 x US3

- 1) Distributor Bulk Pack lockbodies must be ordered with BP option.
- 2) Distributor Bulk Pack lockbodies must be ordered in multiples of **10 per each lock function.** (Quantity of 1 = 1 lockbody; Packed 10 to a box)
- 3) Orders received for less than case quantities will be priced at non-bulk pack prices.
- 4) Distributor Bulk Pack lockbodies **DO NOT** include cylinder and trim sets.
- 5) Distributor Bulk Pack lockbodies **include** outside front, strike, and mounting screws.

How to Order/Notes: Example: TR-8225 LE1P x US3 x RH

- 1) Distributor Bulk Pack trim sets must be ordered: using TR(option) x lock function x trim design x finish x hand (A lever and Escutcheon trim are handed. Please specify hand when ordering).
- 2) Distributor Bulk Pack trim sets must be ordered in multiples of **10 per** design and finish. (Quantity of 1 - 1 trim set; packed 10 to a box)
- 3) Orders received for less than case quantities will be priced at non-bulk pack prices.
- 4) Complete trim sets include spindles, trim pack assemblies, instruction sheets, and templates.
- 5) Split designs and or finishes are not available.
- 6) Components are for 1-3/4” thick doors only.
- 7) Cylinder and lockbodies must be ordered separately.

*Note: “A” lever design and all escutcheon designs are handed. **Please specify hand when ordering.**

ML-92 MORTISE LOCKS

SARGENT®

DISTRIBUTOR BULK PACK PROGRAM

ASSA ABLOY

USA & Canada Prices Effective June 3, 2019

NOTE: Quantity 1 each = 1 lockbody; must be ordered in multiples of 10 each per each lock function

Lockbody ONLY Example: BP-8225 x US3

| 8200 Lockbody Single Cylinder Function | | All Finishes |
|---|-----------|---------------------|
| BP-8204 | Storeroom | \$400.00 |
| BP-8205 | Office | \$400.00 |
| BP-8237 | Classroom | \$400.00 |
| BP-8255 | Office | \$400.00 |

| Single Cylinder Function with Deadbolt | | |
|---|----------------|----------|
| BP-8224 | Storeroom | \$423.00 |
| BP-8225 | Dormitory | \$423.00 |
| BP-8243 | Dwelling Entry | \$423.00 |
| BP-8245 | Dwelling Entry | \$423.00 |

| Non-Keyed | | |
|------------------|---------|----------|
| BP-8215 | Passage | \$335.00 |
| BP-8265 | Privacy | \$376.00 |

| 7800 Lockbody Single Cylinder Function | | All Finishes |
|---|-----------|---------------------|
| BP-7804 | Storeroom | \$383.00 |
| BP-7805 | Office | \$383.00 |
| BP-7837 | Classroom | \$383.00 |

| Single Cylinder Function with Deadbolt | | |
|---|----------------|----------|
| BP-7824 | Storeroom | \$410.00 |
| BP-7825 | Dormitory | \$410.00 |
| BP-7843 | Dwelling Entry | \$410.00 |
| BP-7845 | Dwelling Entry | \$410.00 |

| Non-Keyed | | |
|------------------|---------|----------|
| BP-7815 | Passage | \$318.00 |
| BP-7865 | Privacy | \$362.00 |

USA & Canada Prices Effective June 3, 2019

Quantity 1 each = 1 lockbody set of trim; must be ordered in multiples of 10 each per design and finish.
TRIM ONLY. Lockbodies and cylinders NOT included. Example: TR-8225 LE1P x 03 x RH

| Lock Function | Rose | Lever | 10BE/26D/BSP/WSP | 03/04/09/10/10B/10BL/14/15/20D/26/32/32D |
|------------------------|-------------|-------------|------------------|--|
| TR-8204/8205/8237/8255 | E, L, LN, O | *A, E, F, W | \$526.00 | \$555.00 |
| | E, L, LN, O | B, L, P | \$490.00 | \$523.00 Set |
| | E, L, LN, O | J | \$347.00 | \$383.00 |
| TR-8224/8225/8243/8245 | E, L, LN, O | *A, E, F, W | \$553.00 | \$580.00 |
| | E, L, LN, O | B, L, P | \$514.00 | \$550.00 Set |
| | E, L, LN, O | J | \$371.00 | \$408.00 |
| TR-8215 | E, L, LN, O | *A, E, F, W | \$515.00 | \$546.00 |
| | E, L, LN, O | B, L, P | \$477.00 | \$510.00 Set |
| | E, L, LN, O | J | \$333.00 | \$375.00 |
| TR-8265 | E, L, LN, O | *A, E, F, W | \$576.00 | \$606.00 |
| | E, L, LN, O | B, L, P | \$539.00 | \$573.00 Set |
| | E, L, LN, O | J | \$399.00 | \$436.00 |

| Lock Function | *Escutcheon | Lever | 10BE/26D/BSP/WSP | 03/04/09/10/10B/10BL/14/15/20D/26/32/32D |
|------------------------|-------------|----------|------------------|--|
| TR-8204/8205/8237/8255 | *LE1 | A thru W | \$563.00 | \$599.00 |
| TR-8224/8225/8243/8245 | *LE1 | A thru W | \$592.00 | \$625.00 Set |
| TR-8215 | *LE1 | A thru W | \$555.00 | \$592.00 |
| TR-8265 | *LE1 | A thru W | \$621.00 | \$652.00 |

Add to LE1 prices above:

| | | | | |
|----------------------|------|--|--|-------------|
| Standard Cylinder | *LE2 | x concealed mounting | | \$29.00 |
| Non-Keyed Function | *LE2 | x concealed mounting | | \$29.00 |
| Cylinder Barrel Only | *LE3 | x exposed screws (not avail. in double cyl. functions) | | \$82.00 Set |
| Non-Keyed Function | *LE3 | x exposed screws | | \$29.00 |
| Cylinder Barrel Only | *LE4 | x concealed mounting (not avail. in double cyl. functions) | | \$94.00 |
| Non-Keyed Function | *LE4 | x concealed mounting | | \$29.00 |

| Lock Function | *Escutcheon | Lever | 10BE/26D/BSP/WSP | 03/04/09/10/10B/10BL/14/15/20D/26/32/32D |
|------------------------|-------------|----------|------------------|--|
| TR-8204/8205/8237/8255 | *LW1 | A thru W | \$512.00 | \$549.00 |
| TR-8224/8225/8243/8245 | *LW1 | A thru W | \$541.00 | \$572.00 Set |
| TR-8215 | *LW1 | A thru W | \$503.00 | \$532.00 |
| TR-8265 | *LW1 | A thru W | \$562.00 | \$598.00 |
| TR-8204/8205/8237/8255 | *WT | A thru W | \$480.00 | \$519.00 |
| TR-8224/8225/8243/8245 | *WT | A thru W | \$510.00 | \$541.00 Set |
| TR-8215 | *WT | A thru W | \$474.00 | \$506.00 |
| TR-8265 | *WT | A thru W | \$532.00 | \$568.00 |
| TR-8204/8205/8237/8255 | *LS | A thru W | \$1,033.00 | \$1,061.00 |
| TR-8224/8225/8243/8245 | *LS | A thru W | \$1,061.00 | \$1,085.00 Set |
| TR-8215 | *LS | A thru W | \$1,024.00 | \$1,046.00 |
| TR-8265 | *LS | A thru W | \$1,087.00 | \$1,107.00 |

| Lock Function | *Escutcheon | Lever | 10BE/26D/BSP/WSP | 03/04/09/10/10B/10BL/14/15/20D/26 |
|------------------------|-------------|-------------------------|------------------|-----------------------------------|
| TR-8204/8205/8237/8255 | *FE | A*, B, E, F, J, L, P, W | \$683.00 | \$713.00 |
| TR-8224/8225 | *FE | A*, B, E, F, J, L, P, W | \$710.00 | \$740.00 Set |
| TR-8265 | *FE | A*, B, E, F, J, L, P, W | \$733.00 | \$760.00 |

*Note: "A" lever design and all escutcheon designs are handed. **Please specify hand when ordering.**

ML-94 MORTISE LOCKS

SARGENT®

DISTRIBUTOR BULK PACK PROGRAM 8200 COASTAL SERIES TRIM & 7800 SERIES

ASSA ABLOY

USA & Canada Prices Effective June 3, 2019

Quantity 1 each = 1 set of trim; must be ordered in multiples of 10 each per design and finish.

TRIM ONLY. Lockbodies and cylinders NOT included.

How to Order – Example: TR-8205 CRY x 03 x RH

| Lock Function | Rose | Lever | 10BE/26DBSP/WSP | 03/04/09/10/10B/10BL/14/15/20D/26 |
|------------------------|--------|---------------|-----------------|-----------------------------------|
| TR-8204/8205/8237/8255 | TR, CR | G*, R, S*, Y* | \$526.00 | \$555.00 |
| TR-8224/8225/8243/8245 | TR, CR | G*, R, S*, Y* | \$553.00 | \$580.00 |
| TR-8215 | TR, CR | G*, R, S*, Y* | \$515.00 | \$546.00 |
| TR-8265 | TR, CR | G*, R, S*, Y* | \$576.00 | \$606.00 |

| Lock Function | *Escutcheon | Lever | 10BE/26DBSP/WSP | 03/04/09/10/10B/10BL/14/15/20D/26 |
|-------------------------|-------------|---------------|-----------------|-----------------------------------|
| TR-8204/8205/8237/8255 | TE, CE | G*, R, S*, Y* | \$546.00 | \$584.00 |
| TR-8224/8225/8243/78245 | TE, CE | G*, R, S*, Y* | \$575.00 | \$606.00 |
| TR-8215 | TE, CE | G*, R, S*, Y* | \$539.00 | \$575.00 |
| TR-8265 | TE, CE | G*, R, S*, Y* | \$603.00 | \$633.00 |

| Lock Function | Rose | Lever | 10BE/26DBSP/WSP | 03/04/09/10/10B/10BL/14/15/20D/26/32/32D |
|-------------------------|--|-------|-----------------|--|
| TR-8204/8205/8237/8255 | | | \$526.00 | \$555.00 |
| TR-8224/8225/8243/78245 | O, CO, CR, LN, TO, TR x | | \$553.00 | \$580.00 |
| TR-8215 | All Studio Collection Levers (Except Gramercy Series) | | \$515.00 | \$546.00 |
| TR-8265 | | | \$576.00 | \$606.00 |

| Lock Function | Rose | Lever | 10BE/26DBSP/WSP | 03/04/09/10/10B/10BL/14/15/20D/26/32/32D |
|-------------------------|--|-------|-----------------|--|
| TR-8204/8205/8237/8255 | | | \$546.00 | \$584.00 |
| TR-8224/8225/8243/78245 | CE, TE, LE1 x | | \$575.00 | \$606.00 |
| TR-8215 | All Studio Collection Levers (Except Gramercy Series) | | \$539.00 | \$575.00 |
| TR-8265 | | | \$603.00 | \$633.00 |

| Lock Function | Rose | Knob | 10BE/26DBSP/WSP | 03/04/09/10/10B/10BL/14/15/20D/26/32/32D |
|------------------------|---------|------|-----------------|--|
| TR-7804/7805/7837/7855 | O, E, L | B, C | \$551.00 | \$584.00 |
| TR-7824/7825/7843/7845 | O, E, L | B, C | \$575.00 | \$608.00 |
| TR-7815 | O, E, L | B, C | \$529.00 | \$560.00 |
| TR-7865 | O, E, L | B, C | \$595.00 | \$626.00 |

| Lock Function | *Escutcheon Knob | 10BE/26DBSP/WSP | 03/04/09/10/10B/10BL/14/15/20D/26/32/32D |
|------------------------|------------------|-----------------|--|
| TR-7804/7805/7837/7855 | *WT B, C | \$589.00 | \$626.00 |
| TR-7824/7825/7843/7845 | *WT B, C | \$614.00 | \$646.00 |
| TR-7815 | *WT B, C | \$566.00 | \$598.00 |
| TR-7865 | *WT B, C | \$631.00 | \$670.00 |

| Lock Function | *Escutcheon Knob | 10BE/26DBSP/WSP | 03/04/09/10/10B/10BL/14/15/20D/26/32/32D |
|------------------------|------------------|-----------------|--|
| TR-7804/7805/7837/7855 | *KW1 B, C | \$651.00 | \$680.00 |
| TR-7824/7825/7843/7845 | *KW1 B, C | \$678.00 | \$711.00 |
| TR-7815 | *KW1 B, C | \$628.00 | \$658.00 |
| TR-7865 | *KW1 B, C | \$695.00 | \$727.00 |

| Lock Function | *Escutcheon Knob | 10BE/26DBSP/WSP | 03/04/09/10/10B/10BL/14/15/20D/26/32/32D |
|------------------------|------------------|-----------------|--|
| TR-7804/7805/7837/7855 | *KE1 B, C | \$757.00 | \$789.00 |
| TR-7824/7825/7843/7845 | *KE1 B, C | \$781.00 | \$813.00 |
| TR-7815 | *KE1 B, C | \$732.00 | \$764.00 |
| TR-7865 | *KE1 B, C | \$798.00 | \$831.00 |

| | | | Add to KE1 prices above: |
|----------------------|------|--|--------------------------|
| Standard Cylinder | *KE2 | x concealed mounting. | \$29.00 |
| Non-Keyed Function | *KE2 | x concealed mounting | \$29.00 |
| Cylinder Barrel Only | *KE3 | x exposed screws (not avail. in double cyl. functions) | \$82.00 |
| Non-Keyed Function | *KE3 | x exposed screws | \$29.00 |
| Cylinder Barrel Only | *KE4 | x concealed mounting (not avail. in double cyl. functions) | \$94.00 |
| Non-Keyed Function | *KE4 | x concealed mounting | \$29.00 |

| Lock Function | *Escutcheon Knob | 10BE/26DBSP/WSP | 03/04/09/10/10B/14/15/26/32/32D |
|------------------------|------------------|-----------------|---------------------------------|
| TR-7804/7805/7837/7855 | *KS K | \$1,311.00 | \$1,347.00 |
| TR-7824/7825/7843/7845 | *KS K | \$1,336.00 | \$1,368.00 |
| TR-7815 | *KS K | \$1,288.00 | \$1,326.00 |
| TR-7865 | *KS K | \$1,357.00 | \$1,389.00 |

*Note: All escutcheon designs are handed. G, S, Y lever designs are handed. Please specify hand when ordering.

| 7800/8200/R8200 Lock Bodies Only | | | | |
|---|------------------------------------|---------------------|-------------|--------------|
| Function | | All Finishes | | |
| Single Cyl | Function Description | 7800 | 8200 | R8200 |
| 04 | Storeroom or Closet | | | |
| 05 | Office or Entry | | | |
| 37 | Classroom | | | |
| 06 | Storeroom or Service | \$505.00 | \$541.00 | \$573.00 |
| 31 | Utility | | | |
| 36 | Closet | | | |
| 55 | Office or Entry | | | |
| 56 | Office or Inner Entry | \$528.00 | \$562.00 | \$596.00 |
| 57, 58, 67 | Institutional Privacy | | | |
| 89 | Holdback | N/A | \$562.00 | N/A |
| 91(8291) | All Purpose Holdback | | | |
| Single Cyl With Deadbolt | | | | |
| 24 | Room Door | | | |
| 25 | Dormitory or Exit | | | |
| 27 | Closet or Storeroom | | | |
| 28, 30 | Dummy Trim Deadlock | | | |
| 35 | Storeroom | \$552.00 | \$584.00 | \$619.00 |
| 43 | Apartment Corridor | | | |
| 45 | Dormitory or Exit | | | |
| 47 | Front Door or Apartment Corridor | | | |
| 51 | Storeroom Deadbolt | | | |
| 50 | Hotel Guest Lock | \$552.00 | \$584.00 | \$619.00 |
| Double Cyl No Deadbolt | | | | |
| 16 | Apartment or Exit or Public Toilet | | | |
| 17 | Asylum or Institutional | | | |
| 38 | Classroom Security Intruder | \$505.00 | \$541.00 | \$573.00 |
| 59 | School Security | | | |
| 90 | Classroom Security Holdback | N/A | \$541.00 | N/A |
| 92 | All Purpose Holdback | \$505.00 | \$541.00 | N/A |
| Double Cyl With Deadbolt | | | | |
| 26 | Store Door | | | |
| 29 | Dummy Trim Deadlock | | | |
| 39 | Classroom Security Intruder | | | |
| 40 | Classroom Security Intruder | | | |
| 41 | Classroom Security | \$552.00 | \$584.00 | \$619.00 |
| 46 | Dormitory or Exit | | | |
| 48 | Store Door | | | |
| 49 | Security | | | |
| 52 | Institutional | | | |
| Electro Mechanical Single Cyl – Specify 12V or 24V | | | | |
| 70-12V / 70-24V | Fail Safe | NA | \$892.00 | \$946.00 |
| 71-12V / 71-24V | Fail Secure | | | |
| Electro Mechanical Double Cyl – Specify 12V or 24V | | | | |
| 72-12V / 72-24V | Fail Safe | NA | \$892.00 | \$946.00 |
| 73-12V / 72-24V | Fail Secure | | | |
| Non Keyed | | | | |
| 13 | Communication or Exit | \$505.00 | \$541.00 | \$573.00 |
| 15 | Passage or Closet | \$361.00 | \$390.00 | \$413.00 |
| 65 | Privacy Bedroom or Bath (Latch) | \$452.00 | \$484.00 | \$513.00 |
| 66 | Privacy Bedroom or Bath (Deadbolt) | \$552.00 | \$584.00 | \$619.00 |
| 68 | Privacy Bedroom or Bath (Deadbolt) | \$552.00 | \$584.00 | \$619.00 |
| 95 | Single Dummy Trim w/Lockbody | \$361.00 | \$390.00 | \$413.00 |
| 96 | Double Dummy Trim w/Lockbody | \$361.00 | \$390.00 | \$413.00 |
| 97 | Double Dummy Trim w/Active Trim | \$361.00 | \$390.00 | \$413.00 |

NOTE: Cylinder and trim not included. Outside front, strike and screwpack are included.

For 7800 "PT" Trim (Push/Pull) Lockbodies and 8200 "ALP" Trim, refer to Specialty Hardware section.

Lockbodies with options 1, 3, 68, 69, DX, LX, RX, or any combination, please consult the factory for correct part number and price.

ML-96 MORTISE LOCKS

SARGENT®

8200 TRIM SET PROGRAM

ASSA ABLOY

USA & Canada Prices Effective June 3, 2019

Features of the NEW Sargent Mortise Trim Set Program

- Mortise Trim Set program allows a distributor to purchase a complete inside set of trim or a complete outside set of trim for Sargent's 7800 and 8200 mortise locks.
- No extra parts are required to complete the trim sets.
- All current 7800/8200 trim designs and finishes are available within the NEW Trim Set program.

How to use and order the NEW Trim Set program:

You will need to know function, trim design, finish, and hand (if required) that your trim will be used with

- For a complete inside trim set for Sargent's 8200/7800 mortise lock, use option IS.
Example: IS-8205 LNA x US3 x RH
- For a complete outside trim set for Sargent's 8200/7800 mortise lock, use option OS.
Example: OS-8205 LNA x US3 x RH

- For a complete inside and outside set of trim, you will need to order 1 IS and 1 OS trim pack.
Example: 1 ea IS-8205 LNA x US3 x RH
1 ea OS-8205 LNA x US3 x RH

Note: Cylinders are NOT included within the trim sets. Cylinders must be ordered separately.

3 Easy steps in putting together a complete 8265 LNL x 26D lockset

EXAMPLE:

- | | | | |
|-------------|--------------------------|----------------|---|
| 1. Lockbody | 1 ea 8265 x 26D | refer to ML-55 | includes o/s front and strike |
| 2. I/S Trim | 1 ea IS-8265 x LNL x 26D | refer to ML-57 | includes inside L lever assy., LN rose, 130KB turn lever assy, trim pack. |
| 3. O/S Trim | 1 ea OS-8265 x LNL x 26D | refer to ML-60 | includes outside L lever assy., LN rose, 184W emergency release assy. |

USA & Canada Prices Effective June 3, 2019

Example: IS-8225 LNA x US3 x RH

Inside trim sets include: Inside lever, inside rose or escutcheon, trim pack (spindles, thru-bolt screws, set screw, inside adaptor plate assembly), trim finish screws (for escutcheons). CYLINDERS NOT INCLUDED – Order separately.

*Note: "A" lever design and all escutcheon designs are handed. **Please specify hand when ordering.**

| Lock Function | | | | Rose | Lever | 10BE/26D/BSP/WSP | 03/04/09/10/10B/10BL/14/15/20D/26/32/32D |
|--------------------------------------|----------|----------|----------|---|---------------|------------------|--|
| IS-8204 | IS-8215 | IS-8267 | IS-8291 | E, L, LN, O | A*, E, F, W | \$304.00 | \$317.00 |
| IS-8205 | IS-8237 | IS-8270 | IS-8295 | | B, L, P | \$292.00 | \$310.00 |
| IS-8206 | IS-8255 | IS-8271 | IS-8296 | | J | \$259.00 | \$275.00 |
| IS-8213 | IS-8256 | IS-8289 | IS-8297 | | | | |
| IS-8216 | IS-8238 | IS-8246 | IS-8273 | E, L, LN, O | A*, E, F, W | \$312.00 | \$329.00 |
| IS-8217 | IS-8239 | IS-8248 | IS-8290 | | B, L, P | \$304.00 | \$317.00 |
| IS-8226 | IS-8240 | IS-8252 | IS-8292 | | J | \$263.00 | \$285.00 |
| IS-8229 | IS-8241 | IS-8272 | | | | | |
| IS-8224 | IS-8230 | IS-8250 | IS-8268 | E, L, LN, O | A*, E, F, W | \$341.00 | \$358.00 |
| IS-8225 | IS-8243 | IS-8251 | | | B, L, P | \$330.00 | \$345.00 |
| IS-8227 | IS-8245 | IS-8265 | | | J | \$296.00 | \$314.00 |
| IS-8228 | IS-8247 | IS-8266 | | | | | |
| Lock Function Coastal Trim | | | | Rose | Lever | 10BE/26D/BSP/WSP | 03/04/09/10/10B/10BL/14/15/20D/26 |
| IS-8204 | IS-8215 | IS-8267 | IS-8291 | TR, CR | G*, R, S*, Y* | \$304.00 | \$317.00 |
| IS-8205 | IS-8237 | IS-8270 | IS-8295 | | | | |
| IS-8206 | IS-8255 | IS-8271 | IS-8296 | | | | |
| IS-8213 | IS-8256 | IS-8289 | IS-8297 | | | | |
| IS-8216 | IS-8238 | IS-8246 | IS-8273 | TR, CR | G*, R, S*, Y* | \$312.00 | \$329.00 |
| IS-8217 | IS-8239 | IS-8248 | IS-8290 | | | | |
| IS-8226 | IS-8240 | IS-8252 | IS-8292 | | | | |
| IS-8229 | IS-8241 | IS-8272 | | | | | |
| IS-8224 | IS-8230 | IS-8250 | IS-8268 | TR, CR | G*, R, S*, Y* | \$341.00 | \$358.00 |
| IS-8225 | IS-8243 | IS-8251 | | | | | |
| IS-8227 | IS-8245 | IS-8265 | | | | | |
| IS-8228 | IS-8247 | IS-8266 | | | | | |
| Lock Function Studio Collection Trim | | | | Rose x Lever | | 10BE/26D/BSP/WSP | 03/04/09/10/10B/10BL/14/15/20D/26/32/32D |
| IS-8204 | IS-8215 | IS-8267 | IS-8291 | E2, E3, E4, O, CO, CR, LN, TO, TR x All Studio Collection Levers (Except Gramercy Series) | | \$304.00 | \$317.00 |
| IS-8205 | IS-8237 | IS-8270 | IS-8295 | | | | |
| IS-8206 | IS-8255 | IS-8271 | IS-8296 | | | | |
| IS-8213 | IS-8256 | IS-8289 | IS-8297 | | | | |
| IS-8216 | IS-8238 | IS-8246 | IS-8273 | E2, E3, E4, O, CO, CR, LN, TO, TR x All Studio Collection Levers (Except Gramercy Series) | | \$312.00 | \$329.00 |
| IS-8217 | IS-8239 | IS-8248 | IS-8290 | | | | |
| IS-8226 | IS-8240 | IS-8252 | IS-8292 | | | | |
| IS-8229 | IS-8241 | IS-8272 | | | | | |
| IS-8224 | IS-8230 | IS-8250 | IS-8268 | E2, E3, E4, O, CO, CR, LN, TO, TR x All Studio Collection Levers (Except Gramercy Series) | | \$341.00 | \$358.00 |
| IS-8225 | IS-8243 | IS-8251 | | | | | |
| IS-8227 | IS-8245 | IS-8265 | | | | | |
| IS-8228 | IS-8247 | IS-8266 | | | | | |
| Lock Function Studio Collection Trim | | | | Roseless x Lever | | 10BE/26D/BSP/WSP | 03/04/09/10/10B/10BL/14/15/20D/26 |
| IS-R8204 | IS-R8215 | IS-R8267 | IS-R8296 | R x G, R, S, Y | | \$326.00 | \$340.00 |
| IS-R8205 | IS-R8237 | IS-R8270 | IS-R8297 | | | | |
| IS-R8206 | IS-R8255 | IS-R8271 | IS-R8296 | | | | |
| IS-R8213 | IS-R8256 | IS-R8295 | | | | | |
| IS-R8216 | IS-R8238 | IS-R8246 | IS-R8273 | R x G, R, S, Y | | \$334.00 | \$353.00 |
| IS-R8217 | IS-R8239 | IS-R8248 | IS-R8290 | | | | |
| IS-R8226 | IS-R8240 | IS-R8252 | IS-R8292 | | | | |
| IS-R8229 | IS-R8241 | IS-R8272 | | | | | |
| IS-R8224 | IS-R8230 | IS-R8250 | IS-R8268 | R x G, R, S, Y | | \$365.00 | \$385.00 |
| IS-R8225 | IS-R8243 | IS-R8251 | | | | | |
| IS-R8227 | IS-R8245 | IS-R8265 | | | | | |
| IS-R8228 | IS-R8247 | IS-R8266 | | | | | |
| Lock Function Studio Collection Trim | | | | Roseless x Lever | | 10BE/26D/BSP/WSP | 03/04/09/10/10B/10BL/14/15/20D/26/32/32D |
| IS-R8204 | IS-R8215 | IS-R8267 | IS-R8296 | R x All Studio Collection Levers (Except Gramercy Series) | | \$326.00 | \$340.00 |
| IS-R8205 | IS-R8237 | IS-R8270 | IS-R8297 | | | | |
| IS-R8206 | IS-R8255 | IS-R8271 | IS-R8296 | | | | |
| IS-R8213 | IS-R8256 | IS-R8295 | | | | | |
| IS-R8216 | IS-R8238 | IS-R8246 | IS-R8273 | R x All Studio Collection Levers (Except Gramercy Series) | | \$334.00 | \$353.00 |
| IS-R8217 | IS-R8239 | IS-R8248 | IS-R8290 | | | | |
| IS-R8226 | IS-R8240 | IS-R8252 | IS-R8292 | | | | |
| IS-R8229 | IS-R8241 | IS-R8272 | | | | | |
| IS-R8224 | IS-R8230 | IS-R8250 | IS-R8268 | R x All Studio Collection Levers (Except Gramercy Series) | | \$365.00 | \$385.00 |
| IS-R8225 | IS-R8243 | IS-R8251 | | | | | |
| IS-R8227 | IS-R8245 | IS-R8265 | | | | | |
| IS-R8228 | IS-R8247 | IS-R8266 | | | | | |

ML-98 MORTISE LOCKS

SARGENT®

8200 INSIDE TRIM SET

ASSA ABLOY

USA & Canada Prices Effective June 3, 2019

Example: IS-8225 LNA x US3 x RH

Inside trim sets include: Inside lever, inside rose or escutcheon, trim pack (spindles, thrubolt screws, set screw, inside adaptor plate assembly), trim finish screws (for escutcheons). CYLINDERS NOT INCLUDED – Order separately.

*Note: "A" lever design and all escutcheon designs are handed. **Please specify hand when ordering.**

| Lock Function Coastal Trim | | | | *Esc | Lever | 10BE/26D/BSP/WSP | 03/04/09/10/10B/10BL/14/15/20D/26 |
|--------------------------------------|---------|---------|---------|---|------------------------|---|--|
| IS-8204 | IS-8215 | IS-8267 | IS-8291 | TE, CE | G*, R, S*, Y* | \$424.00 | \$438.00 |
| IS-8205 | IS-8237 | IS-8270 | IS-8295 | | | | |
| IS-8206 | IS-8255 | IS-8271 | IS-8296 | | | | |
| IS-8213 | IS-8256 | IS-8289 | IS-8297 | | | | |
| IS-8216 | IS-8238 | IS-8246 | IS-8273 | TE, CE | G*, R, S*, Y* | \$434.00 | \$463.00 |
| IS-8217 | IS-8239 | IS-8248 | IS-8290 | | | | |
| IS-8226 | IS-8240 | IS-8252 | IS-8292 | | | | |
| IS-8229 | IS-8241 | IS-8272 | | | | | |
| IS-8224 | IS-8230 | IS-8250 | IS-8268 | TE, CE | G*, R, S*, Y* | \$461.00 | \$490.00 |
| IS-8225 | IS-8243 | IS-8251 | | | | | |
| IS-8227 | IS-8245 | IS-8265 | | | | | |
| IS-8228 | IS-8247 | IS-8266 | | | | | |
| Lock Function | | | | *Esc. | Lever | 10BE/26DBSP/WSP | 03/04/09/10/10B/10BL/14/15/20D/26/32/32D |
| IS-8204 | IS-8215 | IS-8267 | IS-8291 | *LW1 | A, B, E, F, J, L, P, W | \$400.00 | \$415.00 |
| IS-8205 | IS-8237 | IS-8270 | IS-8295 | | | | |
| IS-8206 | IS-8255 | IS-8271 | IS-8296 | | | | |
| IS-8213 | IS-8256 | IS-8289 | IS-8297 | | | | |
| IS-8216 | IS-8238 | IS-8246 | IS-8273 | *LW1 | A, B, E, F, J, L, P, W | \$407.00 | \$427.00 |
| IS-8217 | IS-8239 | IS-8248 | IS-8290 | | | | |
| IS-8226 | IS-8240 | IS-8252 | IS-8292 | | | | |
| IS-8229 | IS-8241 | IS-8272 | | | | | |
| IS-8224 | IS-8230 | IS-8250 | IS-8268 | *LW1 | A, B, E, F, J, L, P, W | \$436.00 | \$454.00 |
| IS-8225 | IS-8243 | IS-8251 | | | | | |
| IS-8227 | IS-8245 | IS-8265 | | | | | |
| IS-8228 | IS-8247 | IS-8266 | | | | | |
| Lock Function Gramercy Series Trim | | | | Rose x Lever | | 10BE/BSP/WSP/629/630 | |
| IS-8204 | IS-8215 | IS-8267 | IS-8291 | E2, E3, E4, O, CO, CR, LN, TO, TR x Gramercy Series (RAM-RAS-REM-RGM) | | \$336.00 | |
| IS-8205 | IS-8237 | IS-8270 | IS-8295 | | | | |
| IS-8206 | IS-8255 | IS-8271 | IS-8296 | | | | |
| IS-8213 | IS-8256 | IS-8289 | IS-8297 | | | | |
| IS-8216 | IS-8238 | IS-8246 | IS-8273 | | | | |
| IS-8217 | IS-8239 | IS-8248 | IS-8290 | | | | |
| IS-8226 | IS-8240 | IS-8252 | IS-8292 | | | | |
| IS-8229 | IS-8241 | IS-8272 | | | | | |
| IS-8224 | IS-8230 | IS-8250 | IS-8268 | | | | |
| IS-8225 | IS-8243 | IS-8251 | | | | | |
| IS-8227 | IS-8245 | IS-8265 | | | | | |
| IS-8228 | IS-8247 | IS-8266 | | | | | |
| Lock Function Gramercy Series Trim | | | | Rose x Lever | | 10BE/BSP/WSP/629/630 | |
| IS-8204 | IS-8215 | IS-8267 | IS-8291 | E2, E3, E4, O, CO, CR, LN, TO, TR x Gramercy Series (RAG-RAL-RCM) | | \$357.00 | |
| IS-8205 | IS-8237 | IS-8270 | IS-8295 | | | | |
| IS-8206 | IS-8255 | IS-8271 | IS-8296 | | | | |
| IS-8213 | IS-8256 | IS-8289 | IS-8297 | | | | |
| IS-8216 | IS-8238 | IS-8246 | IS-8273 | | | | |
| IS-8217 | IS-8239 | IS-8248 | IS-8290 | | | | |
| IS-8226 | IS-8240 | IS-8252 | IS-8292 | | | | |
| IS-8229 | IS-8241 | IS-8272 | | | | | |
| IS-8224 | IS-8230 | IS-8250 | IS-8268 | | | | |
| IS-8225 | IS-8243 | IS-8251 | | | | | |
| IS-8227 | IS-8245 | IS-8265 | | | | | |
| IS-8228 | IS-8247 | IS-8266 | | | | | |
| Lock Function Studio Collection Trim | | | | Rose x Lever | | 10BE/26D/BSP/WSP 03/04/09/10/10B/10BL/14/15/20D/26/32/32D | |
| IS-8204 | IS-8215 | IS-8267 | IS-8291 | CE, TE, LE1 x All Studio Collection levers (Except Gramercy Series) | | \$424.00 | \$438.00 |
| IS-8205 | IS-8237 | IS-8270 | IS-8295 | | | | |
| IS-8206 | IS-8255 | IS-8271 | IS-8296 | | | | |
| IS-8213 | IS-8256 | IS-8289 | IS-8297 | | | | |
| IS-8216 | IS-8238 | IS-8246 | IS-8273 | | | | |
| IS-8217 | IS-8239 | IS-8248 | IS-8290 | | | | |
| IS-8226 | IS-8240 | IS-8252 | IS-8292 | | | | |
| IS-8229 | IS-8241 | IS-8272 | | | | | |
| IS-8224 | IS-8230 | IS-8250 | IS-8268 | | | | |
| IS-8225 | IS-8243 | IS-8251 | | | | | |
| IS-8227 | IS-8245 | IS-8265 | | | | | |
| IS-8228 | IS-8247 | IS-8266 | | | | | |

USA & Canada Prices Effective June 3, 2019

Example: IS-8225 WTP x US3 x RH

Inside trim sets include: Inside lever, inside rose or escutcheon, trim pack (spindles, thru-bolt screws, set screw, inside adaptor plate assembly), trim finish screws (for escutcheons). CYLINDERS NOT INCLUDED – Order separately.

*Note: "A" lever design and all escutcheon designs are handed. **Please specify hand when ordering.**

| Lock Function | Gramercy Series | Trim | Esc. x Lever | 10BE/BSP/WSP/629/630 |
|---------------|-----------------|---------|--------------|---|
| IS-8204 | IS-8215 | IS-8267 | IS-8291 | \$364.00 |
| IS-8205 | IS-8237 | IS-8270 | IS-8295 | |
| IS-8206 | IS-8255 | IS-8271 | IS-8296 | |
| IS-8213 | IS-8256 | IS-8289 | IS-8297 | |
| IS-8216 | IS-8238 | IS-8246 | IS-8273 | CE, TE, LE1 x Gramercy Series (RAM-RAS-REM-RGM) \$370.00 |
| IS-8217 | IS-8239 | IS-8248 | IS-8290 | |
| IS-8226 | IS-8240 | IS-8252 | IS-8292 | |
| IS-8229 | IS-8241 | IS-8272 | | |
| IS-8224 | IS-8230 | IS-8250 | IS-8268 | \$395.00 |
| IS-8225 | IS-8243 | IS-8251 | | |
| IS-8227 | IS-8245 | IS-8265 | | |
| IS-8228 | IS-8247 | IS-8266 | | |

| Lock Function | Gramercy Series | Trim | Esc. x Lever | 10BE/BSP/WSP/629/630 |
|---------------|-----------------|---------|--------------|---|
| IS-8204 | IS-8215 | IS-8267 | IS-8291 | \$385.00 |
| IS-8205 | IS-8237 | IS-8270 | IS-8295 | |
| IS-8206 | IS-8255 | IS-8271 | IS-8296 | |
| IS-8213 | IS-8256 | IS-8289 | IS-8297 | |
| IS-8216 | IS-8238 | IS-8246 | IS-8273 | CE, TE, LE1 x Gramercy Series (RAG-RAL-RCM) \$395.00 |
| IS-8217 | IS-8239 | IS-8248 | IS-8290 | |
| IS-8226 | IS-8240 | IS-8252 | IS-8292 | |
| IS-8229 | IS-8241 | IS-8272 | | |
| IS-8224 | IS-8230 | IS-8250 | IS-8268 | \$415.00 |
| IS-8225 | IS-8243 | IS-8251 | | |
| IS-8227 | IS-8245 | IS-8265 | | |
| IS-8228 | IS-8247 | IS-8266 | | |

| Lock Function | *Esc. | Lever | 10BE/26D/BSP/WSP | 03/04/09/10/10B/10BL/14/15/20D/26/32/32D |
|---------------|---------|---------|------------------|---|
| IS-8204 | IS-8215 | IS-8267 | IS-8291 | \$438.00 \$449.00 |
| IS-8205 | IS-8237 | IS-8270 | IS-8295 | |
| IS-8206 | IS-8255 | IS-8271 | IS-8296 | |
| IS-8213 | IS-8256 | IS-8289 | IS-8297 | |
| IS-8216 | IS-8238 | IS-8246 | IS-8273 | *A, B, E, F, J, L, P, W \$445.00 \$463.00 |
| IS-8217 | IS-8239 | IS-8248 | IS-8290 | |
| IS-8226 | IS-8240 | IS-8252 | IS-8292 | |
| IS-8229 | IS-8241 | IS-8272 | | |
| IS-8224 | IS-8230 | IS-8250 | IS-8268 | *LE1 \$473.00 \$490.00 |
| IS-8225 | IS-8243 | IS-8251 | | |
| IS-8227 | IS-8245 | IS-8265 | | |
| IS-8228 | IS-8247 | IS-8266 | | |

| Lock Function | *Esc. | Lever | Add to LE1 prices above: |
|---|-------|-------------------------|--------------------------|
| Standard Cylinder x concealed mounting | *LE2 | *A, B, E, F, J, L, P, W | \$7.00 |
| Non-Keyed Function x concealed mounting | *LE2 | L, P, W | \$7.00 |
| Cylinder Barrel x exposed screws | *LE3 | *A, B, E, F, J, L, P, W | \$42.00 |
| Non-Keyed Function x exposed screws | *LE3 | L, P, W | \$7.00 |
| Cylinder Barrel only x concealed mounting | *LE4 | *A, B, E, F, J, L, P, W | \$50.00 |
| Non-Keyed Function x concealed mounting | *LE4 | L, P, W | \$7.00 |

Note: LE3, LE4 not available w/double cylinder functions

| Lock Function | *Esc. | Lever | 10BE/26D/BSP/WSP | 03/04/09/10/10B/10BL/14/15/20D/26/32/32D |
|---------------|---------|---------|------------------|--|
| IS-8204 | IS-8215 | IS-8267 | IS-8291 | *WT \$389.00 \$402.00 |
| IS-8205 | IS-8237 | IS-8270 | IS-8295 | |
| IS-8206 | IS-8255 | IS-8271 | IS-8296 | |
| IS-8213 | IS-8256 | IS-8289 | IS-8297 | |
| IS-8216 | IS-8238 | IS-8246 | IS-8273 | *WT \$398.00 \$418.00 |
| IS-8217 | IS-8239 | IS-8248 | IS-8290 | |
| IS-8226 | IS-8240 | IS-8252 | IS-8292 | |
| IS-8229 | IS-8241 | IS-8272 | | |
| IS-8224 | IS-8230 | IS-8250 | IS-8268 | *WT \$426.00 \$443.00 |
| IS-8225 | IS-8243 | IS-8251 | | |
| IS-8227 | IS-8245 | IS-8265 | | |
| IS-8228 | IS-8247 | IS-8266 | | |

ML-100 MORTISE LOCKS

SARGENT®

8200 OUTSIDE TRIM SET

ASSA ABLOY

USA & Canada Prices Effective June 3, 2019

Example: OS-8225 LE1P x US3 x RH

Outside trim sets include: Outside lever, outside rose or escutcheon, outside mounting plate, two thrubolt studs, washers, retaining nut, and cylinder rosettes (for cylinder functions only). CYLINDERS NOT INCLUDED – Order separately.

*Note: "A" lever design and all escutcheon designs are handed. **Please specify hand when ordering.**

| Lock Function | *Esc. | Lever | 10BE/26D/BSP/WSP | 03/04/09/10/10B/10BL/14/15/20D/26/32/32D |
|--|-------|-------------------------|------------------|--|
| IS-8204 IS-8206 IS-8215 IS-8205 IS-8213 IS-8237 | *LS | *A, B, E, F, J, L, P, W | \$640.00 | \$651.00 |
| IS-8216 IS-8226 IS-8239 IS-8241 IS-8217 IS-8238 IS-8240 | *LS | *A, B, E, F, J, L, P, W | \$649.00 | \$657.00 |
| IS-8224 IS-8243 IS-8250 IS-8266 IS-8225 IS-8245 IS-8265 | *LS | *A, B, E, F, J, L, P, W | \$675.00 | \$685.00 |

| Lock Function | *Esc. | Lever | 10BE/26D/BSP/WSP | 03/04/09/10/10B/10BL/14/15/20D/26 |
|--|-------|-------------------------|------------------|-----------------------------------|
| IS-8204 IS-8237 IS-8205 | *FE | *A, B, E, F, J, L, P, W | \$460.00 | \$477.00 |
| IS-8216 IS-8226 IS-8239 IS-8217 IS-8238 IS-8240 | *FE | *A, B, E, F, J, L, P, W | \$470.00 | \$484.00 |
| IS-8224 IS-8251 IS-8266 | *FE | *A, B, E, F, J, L, P, W | \$499.00 | \$508.00 |

| Lock Function | Rose | Lever | 10BE/26D/BSP/WSP | 03/04/09/10/10B/10BL/14/15/20D/26/32/32D |
|---|-------------|-------------|------------------|--|
| OS-8204 OS-8229 OS-8241 OS-8255 OS-8205 OS-8230 OS-8243 OS-8256 OS-8216 OS-8231 OS-8245 OS-8267 OS-8217 OS-8235 OS-8246 OS-8270 OS-8224 OS-8236 OS-8247 OS-8271 OS-8225 OS-8237 OS-8248 OS-8272 OS-8226 OS-8238 OS-8250 OS-8273 OS-8227 OS-8239 OS-8251 OS-8289 OS-8228 OS-8240 OS-8252 | E, L, LN, O | A*, E, F, W | \$324.00 | \$341.00 |
| | | B, L, P | \$314.00 | \$330.00 |
| | | J | \$277.00 | \$292.00 |
| OS-8215 OS-8294 OS-8296 OS-8297 | E, L, LN, O | A*, E, F, W | \$314.00 | \$332.00 |
| | | B, L, P | \$306.00 | \$318.00 |
| | | J | \$263.00 | \$285.00 |
| OS-8265 OS-8266 OS-8268 | E, L, LN, O | A*, E, F, W | \$343.00 | \$363.00 |
| | | B, L, P | \$332.00 | \$346.00 |
| | | J | \$296.00 | \$314.00 |

| Lock Function Coastal Trim | Rose | Lever | 10EE/26D/BSP/WSP | 03/04/09/10/10B/10BL/14/15/20D/26 | |
|---|--------|---------------|------------------|-----------------------------------|----------|
| OS-8204 OS-8229 OS-8241 OS-8255 OS-8205 OS-8230 OS-8243 OS-8256 OS-8216 OS-8231 OS-8245 OS-8267 OS-8217 OS-8235 OS-8246 OS-8270 OS-8224 OS-8236 OS-8247 OS-8271 OS-8225 OS-8237 OS-8248 OS-8272 OS-8226 OS-8238 OS-8250 OS-8273 OS-8227 OS-8239 OS-8251 OS-8289 OS-8228 OS-8240 OS-8252 | TR, CR | G*, R, S*, Y* | \$324.00 | \$341.00 | |
| OS-8215 OS-8294 OS-8296 OS-8297 | | TR, CR | G*, R, S*, Y* | \$314.00 | \$332.00 |
| OS-8265 OS-8266 OS-8268 | | TR, CR | G*, R, S*, Y* | \$343.00 | \$363.00 |

| Lock Function Studio Collection Trim | Rose | Lever | 10BE/26D/BSP/WSP | 03/04/09/10/10B/10BL/14/15/20D/26/32/32D |
|---|--|-------|------------------|--|
| OS-8204 OS-8229 OS-8241 OS-8255 OS-8205 OS-8230 OS-8243 OS-8256 OS-8216 OS-8231 OS-8245 OS-8267 OS-8217 OS-8235 OS-8246 OS-8270 OS-8224 OS-8236 OS-8247 OS-8271 OS-8225 OS-8237 OS-8248 OS-8272 OS-8226 OS-8238 OS-8250 OS-8273 OS-8227 OS-8239 OS-8251 OS-8289 OS-8228 OS-8240 OS-8252 | E2, E3, E4, O, CO, CR, LN, TO, TR x All Studio Collection levers (Except Gramercy, Grant Park, Wooster Square Series) | | \$324.00 | \$341.00 |
| OS-8215 OS-8294 OS-8296 OS-8297 | | | \$314.00 | \$332.00 |
| OS-8265 OS-8266 OS-8268 | | | \$343.00 | \$363.00 |

8200 OUTSIDE TRIM SET

USA & Canada Prices Effective June 3, 2019

| Lock Function Studio Collection Trim | Roseless x Lever | 10BE/26D/BSP/WSP | 03/04/09/10/10B/10BL/14/15/20D/26 |
|---|---|------------------|--|
| OS-R8204 OS-R8227 OS-R8238 OS-R8271 OS-R8205 OS-R8228 OS-R8239 OS-R8272 OS-R8216 OS-R8230 OS-R8240 OS-R8273 OS-R8217 OS-R8231 OS-R8252 OS-R8289 OS-R8224 OS-R8235 OS-R8256 OS-R8225 OS-R8236 OS-R8267 OS-R8226 OS-R8237 OS-R8270 | R x G, R, S, Y | \$346.00 | \$358.00 |
| OS-R8215 OS-R8296 OS-R8294 OS-R8297 | | \$330.00 | \$350.00 |
| OS-R8265 OS-R8266 OS-R8268 | | \$362.00 | \$381.00 |
| Lock Function Studio Collection Trim | Roseless x Lever | 10BE/26D/BSP/WSP | 03/04/09/10/10B/10BL/14/15/20D/26/32/32D |
| OS-R8204 OS-R8227 OS-R8238 OS-R8271 OS-R8205 OS-R8228 OS-R8239 OS-R8272 OS-R8216 OS-R8230 OS-R8240 OS-R8273 OS-R8217 OS-R8231 OS-R8252 OS-R8289 OS-R8224 OS-R8235 OS-R8256 OS-R8225 OS-R8236 OS-R8267 OS-R8226 OS-R8237 OS-R8270 | R x All Studio Collection Levers (Except Gramercy, Grant Park, Wooster Square Series) | \$346.00 | \$358.00 |
| OS-R8215 OS-R8296 OS-R8294 OS-R8297 | | \$330.00 | \$350.00 |
| OS-R8265 OS-R8268 OS-R8266 | | \$362.00 | \$381.00 |
| Lock Function Gramercy Series Trim | Rose | Lever | 10BE/BSP/WSP/629/630 |
| OS-8204 OS-8229 OS-8241 OS-8255 OS-8205 OS-8230 OS-8243 OS-8256 OS-8216 OS-8231 OS-8245 OS-8267 OS-8217 OS-8235 OS-8246 OS-8270 OS-8224 OS-8236 OS-8247 OS-8271 OS-8225 OS-8237 OS-8248 OS-8272 OS-8226 OS-8238 OS-8250 OS-8273 OS-8227 OS-8239 OS-8251 OS-8289 OS-8228 OS-8240 OS-8252 OS-8215 OS-8294 OS-8296 OS-8297 OS-8265 OS-8266 OS-8268 | E2, E3, E4, O, CO, CR, LN, TO, TR x Gramercy Series (RAM-RAS-REM-RGM) | | \$356.00 |
| | | | \$347.00 |
| | | | \$372.00 |
| Lock Function Studio Collection Trim | Rose | Lever | 629/630 |
| OS-8204 OS-8229 OS-8241 OS-8255 OS-8205 OS-8230 OS-8243 OS-8256 OS-8216 OS-8231 OS-8245 OS-8267 OS-8217 OS-8235 OS-8246 OS-8270 OS-8224 OS-8236 OS-8247 OS-8271 OS-8225 OS-8237 OS-8248 OS-8272 OS-8226 OS-8238 OS-8250 OS-8273 OS-8227 OS-8239 OS-8251 OS-8289 OS-8228 OS-8240 OS-8252 OS-8215 OS-8294 OS-8296 OS-8297 OS-8265 OS-8266 OS-8268 | E2, E3, E4, O, CO, CR, LN, TO, TR x Gramercy Series (RAL-RCM) | | \$383.00 |
| | | | \$375.00 |
| | | | \$390.00 |

ML-102 MORTISE LOCKS

SARGENT®

8200 OUTSIDE TRIM SET

ASSA ABLOY

USA & Canada Prices Effective June 3, 2019

| Lock Function Coastal Trim | *Esc. x Lever | 10BE/26D/BSP/WSP | 03/04/09/10/10B/10BL/14/15/20D/26 |
|---|---|----------------------|--|
| OS-8204 OS-8229 OS-8241 OS-8255 OS-8205 OS-8230 OS-8243 OS-8256 OS-8216 OS-8231 OS-8245 OS-8267 OS-8217 OS-8235 OS-8246 OS-8270 OS-8224 OS-8236 OS-8247 OS-8271 OS-8225 OS-8237 OS-8248 OS-8272 OS-8226 OS-8238 OS-8250 OS-8273 OS-8227 OS-8239 OS-8251 OS-8289 OS-8228 OS-8240 OS-8252 | *TE, CE | G*, R, S*, Y* | \$445.00 \$461.00 |
| OS-8215 OS-8294 OS-8296 OS-8297 | *TE, CE | G*, R, S*, Y* | \$435.00 \$449.00 |
| OS-8265 OS-8266 OS-8268 | *TE, CE | G*, R, S*, Y* | \$462.00 \$476.00 |
| Lock Function Gramercy Series Trim | Esc. x Lever | 10BE/26D/BSP/WSP | 03/04/09/10/10B/10BL/14/15/20D/26/32/32D |
| OS-8204 OS-8229 OS-8241 OS-8255 OS-8205 OS-8230 OS-8243 OS-8256 OS-8216 OS-8231 OS-8245 OS-8267 OS-8217 OS-8235 OS-8246 OS-8270 OS-8224 OS-8236 OS-8247 OS-8271 OS-8225 OS-8237 OS-8248 OS-8272 OS-8226 OS-8238 OS-8250 OS-8273 OS-8227 OS-8239 OS-8251 OS-8289 OS-8228 OS-8240 OS-8252 | TE, CE, LE1 x All Studio Collection levers (Except Gramercy Series) | | \$445.00 \$461.00 |
| OS-8215 OS-8294 OS-8296 OS-8297 | | | \$435.00 \$449.00 |
| OS-8265 OS-8266 OS-8268 | | | \$462.00 \$476.00 |
| Lock Function Gramercy Series Trim | Esc. x Lever | 10BE/BSP/WSP/629/630 | |
| OS-8204 OS-8229 OS-8241 OS-8255 OS-8205 OS-8230 OS-8243 OS-8256 OS-8216 OS-8231 OS-8245 OS-8267 OS-8217 OS-8235 OS-8246 OS-8270 OS-8224 OS-8236 OS-8247 OS-8271 OS-8225 OS-8237 OS-8248 OS-8272 OS-8226 OS-8238 OS-8250 OS-8273 OS-8227 OS-8239 OS-8251 OS-8289 OS-8228 OS-8240 OS-8252 | TE, CE, LE1 x Gramercy Series (RAM-RAS-REM-RGM) | | \$387.00 |
| OS-8215 OS-8294 OS-8296 OS-8297 | | | \$381.00 |
| OS-8265 OS-8266 OS-8268 | | | \$405.00 |
| Lock Function Gramercy Series Trim | Esc. x Lever | 10BE/BSP/WSP/629/630 | |
| OS-8204 OS-8229 OS-8241 OS-8255 OS-8205 OS-8230 OS-8243 OS-8256 OS-8216 OS-8231 OS-8245 OS-8267 OS-8217 OS-8235 OS-8246 OS-8270 OS-8224 OS-8236 OS-8247 OS-8271 OS-8225 OS-8237 OS-8248 OS-8272 OS-8226 OS-8238 OS-8250 OS-8273 OS-8227 OS-8239 OS-8251 OS-8289 OS-8228 OS-8240 OS-8252 | TE, CE, LE1 x Gramercy Series (RAG-RAL-RCM) | | \$411.00 |
| OS-8215 OS-8294 OS-8296 OS-8297 | | | \$364.00 |
| OS-8265 OS-8266 OS-8268 | | | \$395.00 |

USA & Canada Prices Effective June 3, 2019

Example: OS-8225 LW1P x US3 x RH

Outside trim sets include: Outside lever, outside rose or escutcheon, outside mounting plate, two thrubolt studs, washers, retaining nut, and cylinder rosettes (for cylinder functions only). CYLINDERS NOT INCLUDED – Order separately.

*Note: "A" lever design and all escutcheon designs are handed. **Please specify hand when ordering.**

| Lock Function | *Esc. | Lever | 10BE/26D/BSP/WSP | 03/04/09/10/10B/10BL/14/15/20D/26/32/32D |
|---|-------|-------------------------|------------------|--|
| OS-8204 OS-8229 OS-8241 OS-8255 OS-8205 OS-8230 OS-8243 OS-8256 OS-8216 OS-8231 OS-8245 OS-8267 OS-8217 OS-8235 OS-8246 OS-8270 OS-8224 OS-8236 OS-8247 OS-8271 OS-8225 OS-8237 OS-8248 OS-8272 OS-8226 OS-8238 OS-8250 OS-8273 OS-8227 OS-8239 OS-8251 OS-8289 OS-8228 OS-8240 OS-8252 | *LW1 | *A, B, E, F, J, L, P, W | \$424.00 | \$436.00 |
| OS-8215 OS-8294 OS-8296 OS-8297 | *LW1 | *A, B, E, F, J, L, P, W | \$408.00 | \$415.00 |
| OS-8265 OS-8266 OS-8268 | *LW1 | *A, B, E, F, J, L, P, W | \$439.00 | \$448.00 |

| Lock Function | *Esc. | Lever | 10BE/26D/BSP/WSP | 03/04/09/10/10B/10BL/14/15/20D/26/32/32D |
|---|-------|--------------------------|------------------|--|
| OS-8204 OS-8229 OS-8241 OS-8255 OS-8205 OS-8230 OS-8243 OS-8256 OS-8216 OS-8231 OS-8245 OS-8267 OS-8217 OS-8235 OS-8246 OS-8270 OS-8224 OS-8236 OS-8247 OS-8271 OS-8225 OS-8237 OS-8248 OS-8272 OS-8226 OS-8238 OS-8250 OS-8273 OS-8227 OS-8239 OS-8251 OS-8289 OS-8228 OS-8240 OS-8252 | *LE1 | *A, B, E, F, J, L, P, W, | \$440.00 | \$452.00 |
| OS-8215 OS-8294 OS-8296 OS-8297 | *LE1 | | \$428.00 | \$444.00 |
| OS-8265 OS-8266 OS-8268 | *LE1 | | \$454.00 | \$472.00 |

| Lock Function | *Esc. | Lever | Add to LE1 prices above: | |
|---|-------|----------------------------|--------------------------|------|
| Standard Cylinder x concealed mounting | *LE2 | *A, B, E, F, J, L, P, W | \$7.00 | Each |
| Non-Keved Function x concealed mounting | *LE2 | | \$7.00 | Each |
| Cylinder Barrel x exposed screws | *LE3 | *A, B, E, F, J, L, P, W | \$42.00 | Each |
| Non-Keved Function x exposed screws | *LE3 | | \$7.00 | Each |
| Cylinder Barrel only x concealed mounting | *LE4 | *A, B, E, F, J, L, P, W | \$50.00 | Each |
| Non-Keved Function x concealed mounting | *LE4 | | \$7.00 | Each |

Note: LE3, LE4 not available w/double cylinder functions

| Lock Function | *Esc. | Lever | 10BE/26D/BSP/WSP | 03/04/09/10/10B/10BL/14/15/20D/26/32/32D |
|---|-------|-------------------------|------------------|--|
| OS-8204 OS-8229 OS-8241 OS-8255 OS-8205 OS-8230 OS-8243 OS-8256 OS-8216 OS-8231 OS-8245 OS-8267 OS-8217 OS-8235 OS-8246 OS-8270 OS-8224 OS-8236 OS-8247 OS-8271 OS-8225 OS-8237 OS-8248 OS-8272 OS-8226 OS-8238 OS-8250 OS-8273 OS-8227 OS-8239 OS-8251 OS-8289 OS-8228 OS-8240 OS-8252 | *WT | *A, B, E, F, J, L, P, W | \$412.00 | \$426.00 |
| OS-8215 OS-8294 OS-8296 OS-8297 | *WT | *A, B, E, F, J, L, P, W | \$400.00 | \$419.00 |
| OS-8265 OS-8266 OS-8268 | *WT | *A, B, E, F, J, L, P, W | \$428.00 | \$444.00 |

| Lock Function | *Esc. | Lever | 10BE/26D/BSP/WSP | 03/04/09/10/10B/10BL/14/15/20D/26/32/32D |
|---|-------|-------------------------|------------------|--|
| OS-8204 OS-8229 OS-8241 OS-8255 OS-8205 OS-8230 OS-8243 OS-8256 OS-8216 OS-8231 OS-8245 OS-8267 OS-8217 OS-8235 OS-8246 OS-8270 OS-8224 OS-8236 OS-8247 OS-8271 OS-8225 OS-8237 OS-8248 OS-8272 OS-8226 OS-8238 OS-8250 OS-8273 OS-8227 OS-8239 OS-8251 OS-8289 OS-8228 OS-8240 OS-8252 | *LS | *A, B, E, F, J, L, P, W | \$671.00 | \$680.00 |
| OS-8215 OS-8294 OS-8296 OS-8297 | *LS | *A, B, E, F, J, L, P, W | \$660.00 | \$674.00 |
| OS-8265 OS-8266 OS-8268 | *LS | *A, B, E, F, J, L, P, W | \$691.00 | \$700.00 |

| Lock Function | *Esc. | Lever | 10BE/26D/BSP/WSP | 03/04/09/10/10B/10BL/14/15/20D/26/32/32D |
|--|-------|-------------------------|------------------|--|
| OS-8204 OS-8224 OS-8235 OS-8239 OS-8205 OS-8225 OS-8236 OS-8240 OS-8216 OS-8226 OS-8237 OS-8251 OS-8217 OS-8231 OS-8238 | *FE | *A, B, E, F, J, L, P, W | \$483.00 | \$500.00 |
| OS-8265 OS-8266 | *FE | *A, B, E, F, J, L, P, W | \$502.00 | \$511.00 |

ML-104 MORTISE LOCKS

SARGENT®

7800 INSIDE TRIM SET

ASSA ABLOY

USA & Canada Prices Effective June 3, 2019

Example: IS-7825 KE1B x US3 x RH

Inside trim sets include: Inside knob, inside rose or escutcheon, trim pack (spindles, thrubolt screws, set screws, inside adaptor plate assembly), trim finish screws (for escutcheons). CYLINDERS NOT INCLUDED – Order separately.

*Note: All escutcheon designs are handed. **Please specify hand when ordering.**

| Lock Function | Rose | Lever | 10BE/26D/BSP/WSP | 03/04/09/10/10B/10BL/14/15/20D/26/32/32D |
|-------------------------|---------|-------|------------------|--|
| IS-7804 IS-7815 IS-7867 | | | | |
| IS-7805 IS-7837 IS-7895 | E, L, O | B, C | \$287.00 | \$297.00 |
| IS-7806 IS-7855 IS-7896 | | | | |
| IS-7813 IS-7856 IS-7897 | | | | |

| | | | | |
|-------------------------|---------|------|----------|----------|
| IS-7816 IS-7838 IS-7846 | | | | |
| IS-7817 IS-7839 IS-7848 | E, L, O | B, C | \$292.00 | \$310.00 |
| IS-7826 IS-7840 IS-7852 | | | | |
| IS-7829 IS-7841 IS-7892 | | | | |

| | | | | |
|---------------------------------|---------|------|----------|----------|
| IS-7824 IS-7830 IS-7850 IS-7868 | | | | |
| IS-7825 IS-7843 IS-7851 | E, L, O | B, C | \$322.00 | \$335.00 |
| IS-7827 IS-7845 IS-7865 | | | | |
| IS-7828 IS-7847 IS-7866 | | | | |

| Lock Function | *Esc. | Knob | 10BE/26D/BSP/WSP | 03/04/09/10/10B/10BL/14/15/20D/26/32/32D |
|-------------------------|-------|------|------------------|--|
| IS-7804 IS-7815 IS-7867 | | | | |
| IS-7805 IS-7837 IS-7895 | *KE1 | B, C | \$452.00 | \$471.00 |
| IS-7806 IS-7855 IS-7896 | | | | |
| IS-7813 IS-7856 IS-7897 | | | | |

| | | | | |
|-------------------------|------|------|----------|----------|
| IS-7816 IS-7838 IS-7846 | | | | |
| IS-7817 IS-7839 IS-7848 | *KE1 | B, C | \$464.00 | \$482.00 |
| IS-7826 IS-7840 IS-7852 | | | | |
| IS-7829 IS-7841 IS-7892 | | | | |

| | | | | |
|---------------------------------|------|------|----------|----------|
| IS-7824 IS-7830 IS-7850 IS-7868 | | | | |
| IS-7825 IS-7843 IS-7851 | *KE1 | B, C | \$492.00 | \$505.00 |
| IS-7827 IS-7845 IS-7865 | | | | |
| IS-7828 IS-7847 IS-7866 | | | | |

| Lock Function | *Esc. | Knob | Add to KE1 prices above: | |
|---|-------|------|--------------------------|------|
| Standard Cylinder x concealed mounting | *KE2 | B, C | \$7.00 | Each |
| Non-Keyed Function x concealed mounting | *KE2 | | \$7.00 | Each |
| Cylinder Barrel x exposed screws | *KE3 | B, C | \$44.00 | Each |
| Non-Keyed Function x exposed screws | *KE3 | | \$7.00 | Each |
| Cylinder Barrel only x concealed mounting | *KE4 | B, C | \$52.00 | Each |
| Non-Keyed Function x concealed mounting | *KE4 | | \$7.00 | Each |

Note: KE3, KE4 not available w/double cylinder functions

| Lock Function | *Esc. | Knob | 10BE/26D/BSP/WSP | 03/04/09/10/10B/10BL/14/15/20D/26/32/32D |
|-------------------------|-------|------|------------------|--|
| IS-7804 IS-7815 IS-7867 | | | | |
| IS-7805 IS-7837 IS-7895 | *KW1 | B, C | \$417.00 | \$433.00 |
| IS-7806 IS-7855 IS-7896 | | | | |
| IS-7813 IS-7856 IS-7897 | | | | |

| | | | | |
|-------------------------|------|------|----------|----------|
| IS-7816 IS-7838 IS-7846 | | | | |
| IS-7817 IS-7839 IS-7848 | *KW1 | B, C | \$427.00 | \$443.00 |
| IS-7826 IS-7840 IS-7852 | | | | |
| IS-7829 IS-7841 IS-7892 | | | | |

| | | | | |
|---------------------------------|------|------|----------|----------|
| IS-7824 IS-7830 IS-7850 IS-7868 | | | | |
| IS-7825 IS-7843 IS-7851 | *KW1 | B, C | \$451.00 | \$467.00 |
| IS-7827 IS-7845 IS-7865 | | | | |
| IS-7828 IS-7847 IS-7866 | | | | |

USA & Canada Prices Effective June 3, 2019

Example: IS-7825 WTB x US3 x RH

Inside trim sets include: Inside knob, inside rose or escutcheon, trim pack (spindles, thru-bolt screws, set screws, inside adaptor plate assembly), trim finish screws (for escutcheons). CYLINDERS NOT INCLUDED – Order separately.

*Note: All escutcheon designs are handed. **Please specify hand when ordering.**

| Lock Function | *Esc. | Knob | 10BE/26D/BSP/WSP | 03/04/09/10/10B/10BL/14/15/20D/26/32/32D |
|---------------------------------|-------|------|------------------|--|
| IS-7804 IS-7815 IS-7867 | | | | |
| IS-7805 IS-7837 IS-7895 | *WT | B, C | \$393.00 | \$409.00 |
| IS-7806 IS-7855 IS-7896 | | | | |
| IS-7813 IS-7856 IS-7897 | | | | |
| IS-7816 IS-7838 IS-7846 | | | | |
| IS-7817 IS-7839 IS-7848 | *WT | B, C | \$405.00 | \$417.00 |
| IS-7826 IS-7840 IS-7852 | | | | |
| IS-7829 IS-7841 IS-7892 | | | | |
| IS-7824 IS-7830 IS-7850 IS-7868 | | | | |
| IS-7825 IS-7843 IS-7851 | *WT | B, C | \$431.00 | \$444.00 |
| IS-7827 IS-7845 IS-7865 | | | | |
| IS-7828 IS-7847 IS-7866 | | | | |
| Lock Function | *Esc. | Knob | 10BE/26D/BSP/WSP | 03/04/09/10/10B/10BL/14/15/20D/26/32/32D |
| IS-7804 IS-7815 IS-7867 | | | | |
| IS-7805 IS-7837 IS-7895 | *WT | N | \$423.00 | \$443.00 |
| IS-7806 IS-7855 IS-7896 | | | | |
| IS-7813 IS-7856 IS-7897 | | | | |
| IS-7816 IS-7838 IS-7846 | | | | |
| IS-7817 IS-7839 IS-7848 | *WT | N | \$433.00 | \$450.00 |
| IS-7826 IS-7840 IS-7852 | | | | |
| IS-7829 IS-7841 IS-7892 | | | | |
| IS-7824 IS-7830 IS-7850 IS-7868 | | | | |
| IS-7825 IS-7843 IS-7851 | *WT | N | \$457.00 | \$473.00 |
| IS-7827 IS-7845 IS-7865 | | | | |
| IS-7828 IS-7847 IS-7866 | | | | |
| Lock Function | *Esc. | Knob | 10BE/26D/BSP/WSP | 03/04/09/10/10B/14/15/26/32/32D |
| IS-7804 IS-7806 IS-7815 | *KS | K | \$667.00 | \$679.00 |
| IS-7805 IS-7813 IS-7837 | | | | |
| IS-7816 IS-7826 IS-7839 IS-7841 | *KS | K | \$676.00 | \$691.00 |
| IS-7817 IS-7838 IS-7840 | | | | |
| IS-7824 IS-7843 IS-7850 IS-7866 | *KS | K | \$700.00 | \$718.00 |
| IS-7825 IS-7845 IS-7865 | | | | |
| Lock Function | Rose | Knob | 32D | 32 |
| IS-7804 IS-7815 IS-7867 | | | | |
| IS-7805 IS-7837 IS-7895 | *SL | D | \$730.00 | \$733.00 |
| IS-7806 IS-7855 IS-7896 | | | | |
| IS-7813 IS-7856 IS-7897 | | | | |
| IS-7816 IS-7838 IS-7846 | | | | |
| IS-7817 IS-7839 IS-7848 | *SL | D | \$736.00 | \$739.00 |
| IS-7826 IS-7840 IS-7852 | | | | |
| IS-7829 IS-7841 IS-7892 | | | | |
| IS-7824 IS-7830 IS-7850 IS-7868 | | | | |
| IS-7825 IS-7843 IS-7851 | *SL | D | \$762.00 | \$764.00 |
| IS-7827 IS-7845 IS-7865 | | | | |
| IS-7828 IS-7847 IS-7866 | | | | |

ML-106 MORTISE LOCKS

SARGENT®

7800 OUTSIDE TRIM SET

ASSA ABLOY

USA & Canada Prices Effective June 3, 2019

Example: OS-7825 KW1B x US3 x RH

Outside trim sets include: Outside knob, outside rose or escutcheon, outside mounting plate, two thru-bolt studs, washers, retaining nut, and cylinder rosettes (for cylinder functions only). CYLINDERS NOT INCLUDED – Order separately.

*Note: All escutcheon designs are handed. **Please specify hand when ordering.**

| Lock Function | Rose | Knob | 10BE/26D/BSP/WSP | 03/04/09/10/10B/10BL/14/15/20D/26/32/32D |
|--|---------|------|--------------------------|--|
| OS-7804 OS-7829 OS-7841 OS-7855 | | | | |
| OS-7805 OS-7830 OS-7843 OS-7856 | | | | |
| OS-7816 OS-7831 OS-7845 OS-7867 | | | | |
| OS-7817 OS-7835 OS-7846 | | | | |
| OS-7824 OS-7836 OS-7847 | E, L, O | B, C | \$302.00 | \$319.00 |
| OS-7825 OS-7837 OS-7848 | | | | |
| OS-7826 OS-7838 OS-7850 | | | | |
| OS-7827 OS-7839 OS-7851 | | | | |
| OS-7828 OS-7840 OS-7852 | | | | |
| OS-7815 OS-7894 OS-7896 OS-7897 | E, L, O | B, C | \$292.00 | \$310.00 |
| OS-7865 OS-7866 OS-7868 | E, L, O | B, C | \$322.00 | \$335.00 |
| Lock Function | *Esc. | Knob | 10BE/26D/BSP/WSP | 03/04/09/10/10B/10BL/14/15/20D/26/32/32D |
| OS-7804 OS-7829 OS-7841 OS-7855 | | | | |
| OS-7805 OS-7830 OS-7843 OS-7856 | | | | |
| OS-7816 OS-7831 OS-7845 OS-7867 | | | | |
| OS-7817 OS-7835 OS-7846 | | | | |
| OS-7824 OS-7836 OS-7847 | *KE1 | B, C | \$482.00 | \$498.00 |
| OS-7825 OS-7837 OS-7848 | | | | |
| OS-7826 OS-7838 OS-7850 | | | | |
| OS-7827 OS-7839 OS-7851 | | | | |
| OS-7828 OS-7840 OS-7852 | | | | |
| OS-7815 OS-7894 OS-7896 OS-7897 | *KE1 | B, C | \$471.00 | \$488.00 |
| OS-7865 OS-7866 OS-7868 | *KE1 | B, C | \$499.00 | \$512.00 |
| Lock Function | *Esc. | Knob | Add to KE1 prices above: | |
| Standard Cylinder x concealed mounting | *KE2 | B, C | \$7.00 | Each |
| Non-Keyed Function x concealed mounting | *KE2 | | \$7.00 | Each |
| Cylinder Barrel x exposed screws | *KE3 | B, C | \$43.00 | Each |
| Non-Keyed Function x exposed screws | *KE3 | | \$7.00 | Each |
| Cylinder Barrel only x concealed mounting | *KE4 | B, C | \$50.00 | Each |
| Non-Keyed Function x concealed mounting | *KE4 | | \$7.00 | Each |
| Note: KE3, KE4 not available w/double cylinder functions | | | | |
| Lock Function | *Esc. | Knob | 10BE/26D/BSP/WSP | 03/04/09/10/10B/10BL/14/15/20D/26/32/32D |
| OS-7804 OS-7829 OS-7841 OS-7855 | | | | |
| OS-7805 OS-7830 OS-7843 OS-7856 | | | | |
| OS-7816 OS-7831 OS-7845 OS-7867 | | | | |
| OS-7817 OS-7835 OS-7846 | | | | |
| OS-7824 OS-7836 OS-7847 | *KW1 | B, C | \$439.00 | \$451.00 |
| OS-7825 OS-7837 OS-7848 | | | | |
| OS-7826 OS-7838 OS-7850 | | | | |
| OS-7827 OS-7839 OS-7851 | | | | |
| OS-7828 OS-7840 OS-7852 | | | | |
| OS-7815 OS-7894 OS-7896 OS-7897 | *KW1 | B, C | \$431.00 | \$444.00 |
| OS-7865 OS-7866 OS-7868 | *KW1 | B, C | \$452.00 | \$471.00 |

USA & Canada Prices Effective June 3, 2019

Example: OS-7825 KW1B x US3 x RH

Outside trim sets include: Outside knob, outside rose or escutcheon, outside mounting plate, two thru-bolt studs, washers, retaining nut, and cylinder rosettes (for cylinder functions only). CYLINDERS NOT INCLUDED – Order separately.

*Note: All escutcheon designs are handed. **Please specify hand when ordering.**

| Lock Function | *Esc. | Knob | 10BE/26D/BSP/WSP | 03/04/09/10/10B/10BL/14/15/20D/26/32/32D |
|---------------------------------|-------|------|------------------|--|
| OS-7804 OS-7829 OS-7841 OS-7855 | | | | |
| OS-7805 OS-7830 OS-7843 OS-7856 | | | | |
| OS-7816 OS-7831 OS-7845 OS-7867 | | | | |
| OS-7817 OS-7835 OS-7846 | | | | |
| OS-7824 OS-7836 OS-7847 | *WT | B, C | \$413.00 | \$431.00 |
| OS-7825 OS-7837 OS-7848 | | | | |
| OS-7826 OS-7838 OS-7850 | | | | |
| OS-7827 OS-7839 OS-7851 | | | | |
| OS-7828 OS-7840 OS-7852 | | | | |
| OS-7815 OS-7894 OS-7896 OS-7897 | *WT | B, C | \$406.00 | \$418.00 |
| OS-7865 OS-7866 OS-7868 | *WT | B, C | \$432.00 | \$445.00 |
| Lock Function | *Esc. | Knob | 10BE/26D/BSP/WSP | 03/04/09/10/10B/10BL/14/15/20D/26/32/32D |
| OS-7804 OS-7829 OS-7841 OS-7855 | | | | |
| OS-7805 OS-7830 OS-7843 OS-7856 | | | | |
| OS-7816 OS-7831 OS-7845 OS-7867 | | | | |
| OS-7817 OS-7835 OS-7846 | | | | |
| OS-7824 OS-7836 OS-7847 | *WT | N | \$445.00 | \$463.00 |
| OS-7825 OS-7837 OS-7848 | | | | |
| OS-7826 OS-7838 OS-7850 | | | | |
| OS-7827 OS-7839 OS-7851 | | | | |
| OS-7828 OS-7840 OS-7852 | | | | |
| OS-7815 OS-7894 OS-7896 OS-7897 | *WT | N | \$439.00 | \$452.00 |
| OS-7865 OS-7866 OS-7868 | *WT | N | \$463.00 | \$478.00 |
| Lock Function | *Esc. | Knob | 10BE/26D/BSP/WSP | 03/04/09/10/10B/10BL/14/15/26/32/32D |
| OS-7804 OS-7825 OS-7837 OS-7843 | | | | |
| OS-7805 OS-7826 OS-7838 OS-7845 | | | | |
| OS-7816 OS-7831 OS-7839 OS-7850 | *KS | K | \$698.00 | \$716.00 |
| OS-7817 OS-7835 OS-7840 | | | | |
| OS-7824 OS-7836 OS-7841 | | | | |
| OS-7815 | *KS | K | \$691.00 | \$705.00 |
| OS-7865 OS-7866 | *KS | K | \$718.00 | \$732.00 |
| Lock Function | Rose | Knob | 32D | 32 |
| OS-7804 OS-7829 OS-7841 OS-7855 | | | | |
| OS-7805 OS-7830 OS-7843 OS-7856 | | | | |
| OS-7816 OS-7831 OS-7845 OS-7867 | | | | |
| OS-7817 OS-7835 OS-7846 | | | | |
| OS-7824 OS-7836 OS-7847 | SL | D | \$788.00 | \$790.00 |
| OS-7825 OS-7837 OS-7848 | | | | |
| OS-7826 OS-7838 OS-7850 | | | | |
| OS-7827 OS-7839 OS-7851 | | | | |
| OS-7828 OS-7840 OS-7852 | | | | |
| OS-7815 OS-7894 OS-7896 OS-7897 | SL | D | \$763.00 | \$766.00 |
| OS-7865 OS-7866 OS-7868 | SL | D | \$789.00 | \$791.00 |

ML-108 MORTISE LOCKS

SARGENT®

8200 LEVERS

ASSA ABLOY

USA & Canada Prices Effective June 3, 2019

| Outside Levers Part # | Design | 10BE/26D/BSP/WSP | 03/04/09/10/10B/10BL/ 14/15/20D/26/32/32D |
|--------------------------|------------|------------------|--|
| 82-0151 | A - RH/RHR | \$157.05 | \$175.10 |
| 82-0152 | A - LH/LHR | \$157.05 | \$175.10 |
| 82-0153 | B | \$145.03 | \$163.62 |
| 82-0154 | E | \$157.05 | \$175.10 |
| 82-0155 | F | \$157.05 | \$175.10 |
| 82-0156 | J | \$119.01 | \$137.61 |
| 97-0486 (for FE Esc) | J | \$127.94 | \$147.94 |
| 82-0157 | L | \$145.03 | \$163.62 |
| 97-0485 (for FE Esc) | L | \$155.93 | \$175.92 |
| 82-0158 | P | \$145.03 | \$163.62 |
| 97-0484 (for FE Esc) | P | \$155.93 | \$175.92 |
| 82-0159 | W | \$157.05 | \$175.10 |

| Outside Coastal Series Levers Part # | Design | 10BE/26D/BSP/WSP | 03/04/09/10/10B/10BL/ 14/15/20D/26 |
|---|------------|------------------|---------------------------------------|
| 82-0517 | R | | |
| 82-0522 | S - LH/LHR | | |
| 82-0523 | S - RH/RHR | \$157.05 | \$175.10 |
| 82-0526 | G - LH/LHR | | |
| 82-0527 | G - RH/RHR | | |
| 82-0530 | Y - LH/LHR | | |
| 82-0531 | Y - RH/RHR | | |

| Outside Studio Collection Levers Part # | Design | 10BE/26D/BSP/WSP | 03/04/09/10/10B/10BL/ 14/15/20D/26/32/32D |
|--|---------|------------------|--|
| 82-0803 | MA | | |
| 82-0806 | MB | | |
| 82-0809 | MC | | |
| 82-0812 | MD | | |
| 82-0815 | ME | | |
| 82-0818 | MF | | |
| 82-0821 | MG | | |
| 82-0824 | MH - RH | | |
| 82-0827 | MH - LH | | |
| 82-0830 | MI | | |
| 82-0833 | MJ | | |
| 82-0836 | MK - RH | | |
| 82-0839 | MK - LH | | |
| 82-0848 | MM - RH | | |
| 82-0851 | MM - LH | | |
| 82-0854 | MN - RH | | |
| 82-0857 | MN - LH | | |
| 82-0860 | MO | | |
| 82-0863 | MP | | |
| 82-0866 | MQ - RH | | |
| 82-0869 | MQ - LH | | |
| 82-1243 | MS - RH | \$157.05 | \$175.10 |
| 82-1244 | MS - LH | | |
| 82-0881 | MT - RH | | |
| 82-0884 | MT - LH | | |
| 82-1251 | MU - RH | | |
| 82-1252 | MU - LH | | |
| 82-0893 | MV - RH | | |
| 82-0896 | MV - LH | | |
| 82-0899 | MW | | |
| 82-1087 | MX - RH | | |
| 82-1090 | MX - LH | | |
| 82-1075 | MY - RH | | |
| 82-1078 | MY - LH | | |
| 82-1081 | MZ - RH | | |
| 82-1084 | MZ - LH | | |
| 82-0909 | ND | | |
| 82-1277 | NF | | |
| 82-0915 | NJ | | |
| 82-0903 | NS - RH | | |
| 82-0906 | NS - LH | | |
| 82-1066 | NU - RH | | |
| 82-1069 | NU - LH | | |

| 8200 Outside Gramercy Series Levers | | | |
|-------------------------------------|--------------------------|--------|----------|
| Part# | Available Finishes | Design | Price |
| RW-2002 | 2929 or 3030 | REM | \$172.69 |
| RW-2006 | 2930, 3030, or 2930 | RCM | \$219.37 |
| RW-2018 | 29BK or 30BK | RAS | \$172.69 |
| RW-2022 | 29BK, 29BN or 30BK, 30BN | RAL | \$235.72 |
| RW-2026 | 2929 or 3030 | RGM | \$172.69 |
| RW-2030 | 2929 or 3030 | RAG | \$219.37 |

| 8200 Outside Wooster Square and Grant Park Levers | | | 03/04/09/10/10B/10BL/ 14/15/20D/26/32/32D |
|---|--------|------------------|--|
| Part# | Design | 10BE/26D/BSP/WSP | |
| 82-1582 | H001 | | |
| 82-1585 | H002 | | |
| 82-5266 | H003 | | |
| 82-5269 | H004 | | |
| 82-5272 | H005 | | |
| 82-5275 | H006 | \$195.52 | \$213.20 |
| 82-1594 | H007 | | |
| 82-1599 | H008 | | |
| 82-1603 | H009 | | |
| 82-1606 | H010 | | |
| 82-1609 | H011 | | |

ASSA ABLOY, the global leader
in door opening solutions

Copyright © 2002-2019 Sargent Manufacturing Company, an ASSA ABLOY Group company. All rights reserved.
Reproduction in whole or in part without the express written permission of Sargent Manufacturing Company is prohibited.
Contact us at: 800-727-5477 or visit www.sargentlock.com. In Canada contact us at: 800-461-3007 or visit www.assaabloydss.ca

| Inside Levers | | 03/04/09/10/10B/10BL | |
|---------------|------------|----------------------|---------------------|
| Part # | Design | 10BE/26D/BSP/WSP | 14/15/20D/26/32/32D |
| 81-0467 | A - LH/LHR | \$157.05 | \$175.10 |
| 81-0468 | A - RH/RHR | \$157.05 | \$175.10 |
| 81-0490 | B | \$145.03 | \$163.62 |
| 81-0470 | E | \$157.05 | \$175.10 |
| 81-0471 | F | \$157.05 | \$175.10 |
| 81-0447 | J | \$119.01 | \$137.61 |
| 81-0489 | L | \$145.03 | \$163.62 |
| 81-0513 | P | \$145.03 | \$163.62 |
| 81-0445 | W | \$157.05 | \$175.10 |

| Inside Coastal Series Levers | | 03/04/09/10/10B/10BL | |
|------------------------------|------------|----------------------|--------------|
| Part # | Design | 10BE/26D/BSP/WSP | 14/15/20D/26 |
| 82-0516 | R | | |
| 82-0520 | S - LH/LHR | | |
| 82-0521 | S - RH/RHR | | |
| 82-0524 | G - LH/LHR | \$157.05 | \$175.10 |
| 82-0525 | G - RH/RHR | | |
| 82-0528 | Y - LH/LHR | | |
| 82-0529 | Y - RH/RHR | | |

| 8200 Inside Studio Collection Levers | | 03/04/09/10/10B/10BL/ | |
|--------------------------------------|---------|-----------------------|---------------------|
| Part # | Design | 10BE/26D/BSP/WSP | 14/15/20D/26/32/32D |
| 82-0802 | MA | | |
| 82-0805 | MB | | |
| 82-0808 | MC | | |
| 82-0811 | MD | | |
| 82-0814 | ME | | |
| 82-0817 | MF | | |
| 82-0820 | MG | | |
| 82-0823 | MH - LH | | |
| 82-0826 | MH - RH | | |
| 82-0829 | MI | | |
| 82-0832 | MJ | | |
| 82-0835 | MK - LH | | |
| 82-0838 | MK - RH | | |
| 82-0847 | MM - LH | | |
| 82-0850 | MM - RH | | |
| 82-0853 | MN - LH | | |
| 82-0856 | MN - RH | | |
| 82-0859 | MO | | |
| 82-0862 | MP | | |
| 82-0865 | MQ - LH | | |
| 82-0868 | MQ - RH | | |
| 82-1241 | MS - LH | \$157.05 | \$175.10 |
| 82-1242 | MS - RH | | |
| 82-0880 | MT - LH | | |
| 82-0883 | MT - RH | | |
| 82-1250 | MU - LH | | |
| 82-1249 | MU - RH | | |
| 82-0892 | MV - LH | | |
| 82-0895 | MV - RH | | |
| 82-0898 | MW | | |
| 82-1086 | MX - RH | | |
| 82-1089 | MX - LH | | |
| 82-1074 | MY - RH | | |
| 82-1077 | MY - LH | | |
| 82-1080 | MZ - RH | | |
| 82-1083 | MZ - LH | | |
| 82-0908 | ND | | |
| 82-1276 | NF | | |
| 82-0914 | NJ | | |
| 82-0902 | NS - RH | | |
| 82-0905 | NS - LH | | |
| 82-1065 | NU - RH | | |
| 82-1068 | NU - LH | | |

Note: Inside lever handle is used for outside trim with 31, 35, 36 (trim-one-side) functions.

Note: Levers provided with lever spring & set screw. Handed levers should be ordered to the hand of the door – example: a RH door/lock will need a RH O/S lever and a RH I/S lever.

| 8200 Inside Gramercy Series Levers | | | |
|------------------------------------|--------------------------|--------|----------|
| Part# | Available Finishes | Design | Price |
| RW-2001 | 2929 or 3030 | REM | \$172.69 |
| RW-2005 | 2930, 3030, or 2930 | RCM | \$219.37 |
| RW-2009 | 2930 | RAM | \$172.69 |
| RW-2017 | 29BK or 30BK | RAS | \$172.69 |
| RW-2021 | 29BK, 29BN or 30BK, 30BN | RAL | \$235.72 |
| RW-2025 | 2929 or 3030 | RGM | \$172.69 |
| RW-2029 | 2929 or 3030 | RAG | \$219.37 |

| 8200 Inside Wooster Square and Grant Park Levers | | 03/04/09/10/10B/10BL/ | |
|--|--------|-----------------------|---------------------|
| Part# | Design | 10BE/26D/BSP/WSP | 14/15/20D/26/32/32D |
| 82-1581 | H001 | | |
| 82-1584 | H002 | | |
| 82-5265 | H003 | | |
| 82-5268 | H004 | | |
| 82-5271 | H005 | | |
| 82-5274 | H006 | \$195.52 | \$213.20 |
| 82-1593 | H007 | | |
| 82-1597 | H008 | | |
| 82-1602 | H009 | | |
| 82-1605 | H010 | | |
| 82-1608 | H011 | | |

ML-110 MORTISE LOCKS

SARGENT®

8200 MILLED LEVERS & 7800 KNOBS

ASSA ABLOY

USA & Canada Prices Effective June 3, 2019

| Milled Outside Levers | | | 03/04/09/10/10B/10BL/ 14/15/20D/26/32/32D |
|-----------------------|------------|------------------|--|
| Part # | Design | 10BE/26D/BSP/WSP | |
| 82-0306 | A - LH/LHR | \$253.05 | \$271.65 |
| 82-0307 | A - RH/RHR | \$253.05 | \$271.65 |
| 82-0308 | B | \$236.30 | \$254.90 |
| 82-0311 | E | \$253.05 | \$271.65 |
| 82-0312 | F | \$253.05 | \$271.65 |
| 82-0309 | J | \$210.28 | \$228.84 |
| 82-0313 | L | \$236.30 | \$254.90 |
| 82-0314 | P | \$236.30 | \$254.90 |
| 82-0310 | W | \$253.05 | \$271.65 |
| Milled Inside Levers | | | 03/04/09/10/10B/10BL/ 14/15/20D/26/32/32D |
| Part # | Design | 10BE/26D/BSP/WSP | |
| 82-0315 | A - LH/LHR | \$253.05 | \$271.65 |
| 82-0316 | A - RH/RHR | \$253.05 | \$271.65 |
| 82-0317 | B | \$236.30 | \$254.90 |
| 82-0320 | E | \$253.05 | \$271.65 |
| 82-0321 | F | \$253.05 | \$271.65 |
| 82-0318 | J | \$210.28 | \$228.84 |
| 82-0322 | L | \$236.30 | \$254.90 |
| 82-0323 | P | \$236.30 | \$254.90 |
| 82-0319 | W | \$253.05 | \$271.65 |
| Outside Knobs | | | 03/04/09/10/10B/10BL/ 14/15/20D/26/32/32D |
| Part # | Design | 10BE/26D/BSP/WSP | |
| 78-2875 | B | \$133.15 | \$134.98 |
| 78-2876 | C | \$133.15 | \$134.98 |
| 78-2742 | K | \$235.33 | - |
| 78-2759 | N | \$133.15 | \$134.98 |
| 92-0084 | D | \$390.80 (32D) | \$406.42 (32) |
| Inside Knobs | | | 03/04/09/10/10B/10BL/ 14/15/20D/26/32/32D |
| Part # | Design | 10BE/26D/BSP/WSP | |
| 78-2877 | B | \$133.15 | \$134.98 |
| 78-0508 | C | \$133.15 | \$134.98 |
| 78-2743 | K | \$235.33 | - |
| 78-2755 | N | \$133.15 | \$134.98 |
| 92-0086 | D | \$390.80 (32D) | \$406.42 (32) |

Note: B & C Knob not available on KS Escutcheon.
 (1485) K Knob only available on KS Escutcheon.
 (1673) N Knob only available on WT Escutcheon.

Note: Inside lever/knob handle is used for outside trim with 31, 35, 36 (trim-one-side) functions.

Note: Levers provided with lever spring & set screw.
 Handed levers should be ordered to the hand of the door - example: a RH door/lock will need a RH O/S lever and a RH I/S lever

USA & Canada Prices Effective June 3, 2019

| Inside Escutcheons Part # | Design | Used for following Functions | 03/04/09/10/10B/10BL/ 14/15/20D/26/32/32D | |
|------------------------------|--------------------|---------------------------------|--|------------------------------|
| | | | 10BE/26D/BSP/WSP | |
| 77-0736 | KE (78) | Blank | \$156.83 | \$160.54 |
| 81-0556 | LE1/3/4 KE1/3/4 | Lever Only | \$158.72 | \$162.36 |
| 77-2300 | LE1/3/4 KE1/3/4 | Turn Lever Only | \$173.76 | \$177.38 |
| 81-4645 | LE1/3/4 KE1/3/4 | Knob/Lever & Turn Lever | \$175.56 | \$179.22 |
| 77-0062 | LE1/KE1 | Cyl. Only | \$158.72 | \$162.36 |
| 81-0559 | LE1/KE1 | Knob/Lever & Cyl. | \$160.54 | \$164.17 |
| 77-2951 | LE1/KE1 | Cyl. & Turn Lever | \$175.56 | \$179.22 |
| 81-0563 | LE2/KE2 | Knob/Lever Only | \$158.72 | \$162.36 |
| 77-3477 | LE2/KE2 | Turn Lever Only | \$173.76 | \$177.38 |
| 81-4647 | LE2/KE2 | Knob/Lever & Turn Lever | \$175.56 | \$179.22 |
| 77-0742 | LE2/KE2 | Cyl. Only | \$158.72 | \$162.36 |
| 81-0562 | LE2/KE2 | Knob/Lever & Cyl. | \$160.54 | \$164.17 |
| 77-3473 | LE2/KE2 | Cyl. & Turn Lever | \$175.56 | \$179.22 |
| 81-0579 | LS/KS | Blank | \$333.82 | \$337.49 |
| 81-0576 | LS/KS | Knob/Lever Only | \$335.64 | \$339.29 |
| 81-4684 | LS/KS | Turn Lever Only | \$350.71 | \$354.34 |
| 81-4682 | LS/KS | Knob/Lever & Turn Lever | \$354.34 | \$358.01 |
| 81-0581 | LS/KS | Cyl. Only | \$335.64 | \$339.29 |
| 81-0577 | LS/KS | Knob/Lever & Cyl. | \$339.29 | \$342.93 |
| 81-4685 | LS/KS | Cyl. & Turn Lever | \$354.34 | \$342.93 |
| 81-0647 | WT (78/82) | Knob/Lever Only | \$109.47 | \$113.10 |
| 81-4699 | WT (78/82) | Turn Lever Only | \$124.48 | \$128.14 |
| 81-4594 | WT (78/82) | Knob/Lever & Turn Lever | \$128.14 | \$131.78 |
| 81-0651 | WT (78/82) | Cyl. Only | \$109.47 | \$113.09 |
| 81-0648 | WT (78/82) | Knob/Lever & Cyl. | \$113.09 | \$116.74 |
| 81-4698 | WT (78/82) | Turn Lever & Cyl. | \$128.14 | \$131.78 |
| 81-0646 | WT(78/82) | Blank | \$107.47 | \$111.10 |
| 77-3428 | LW1/KW1 | Knob/Lever Only | \$116.74 (10BE only) | \$120.41 |
| 82-1371 | LW1/KW1 | Knob/Lever Only | \$116.74 (26D only) | - |
| 77-3427 | LW1/KW1 | Blank | \$116.74 (10BE only) | \$120.41 |
| 82-1370 | LW1/KW1 | Blank | \$116.74 (26D only) | - |
| 77-3435 | LW1/KW1 | Turn Lever Only | \$131.78 | \$135.42 |
| 77-3432 | LW1/KW1 | Knob/Lever & Turn Lever | \$133.60 | \$137.27 |
| 77-3430 | LW1/KW1 | Cyl. Only | \$116.74 (10BE only) | \$120.41 |
| 82-1373 | LW1/KW1 | Cyl. Only | \$116.74 (26D only) | - |
| 77-3429 | LW1/KW1 | Knob/Lever & Cyl. | \$118.59 (10BE only) | \$122.22 |
| 82-1372 | LW1/KW1 | Knob/Lever & Cyl. | \$118.59 (26D only) | - |
| 77-3431 | LW1/KW1 | Cyl. & Turn | \$118.59 | \$122.22 |
| 77-5978 | LW1/KW1 | Cyl & Lever (31, 35, 36) | \$118.59 (10BE only) | \$122.22 (32 & 32D only) |
| 77-1486 | LW1/KW1 | Cyl & Lever (31, 35, 36) | \$118.59 (26D only) | \$122.22 (N/A with 32 & 32D) |

ML-112 MORTISE LOCKS

SARGENT®

8200 - INSIDE ESCUTCHEONS

ASSA ABLOY

USA & Canada Prices Effective June 3, 2019

| Inside Coastal Series Escutcheons | | | | 03/04/09/10/10B/10BL/ 14/15/20D/26 |
|-----------------------------------|--------|--------------------|------------------|---------------------------------------|
| Part # | Design | Used for Functions | 10BE/26D/BSP/WSP | |
| 82-0544 | CE | Lever Only | \$193.36 | \$230.55 |
| 82-0546 | CE | Cyl. Only | \$193.36 | \$230.55 |
| 82-0547 | CE | Lever & Cyl. | \$195.23 | \$232.43 |
| 82-0548 | CE | Blank-Dummy | \$191.51 | \$228.70 |
| 82-3907 | CE | Turn Lever Only | \$208.68 | \$245.88 |
| 82-3909 | CE | Lever & Turn Lever | \$210.56 | \$247.76 |
| 82-3911 | CE | Cyl. & Turn Lever | \$210.56 | \$247.76 |
| 82-0514 | TE | Blank | \$191.51 | \$228.70 |
| 82-0560 | TE | Lever Only | \$193.36 | \$230.55 |
| 82-0562 | TE | Cyl. Only | \$193.36 | \$230.55 |
| 82-0563 | TE | Lever & Cyl. | \$195.23 | \$232.43 |
| 82-0564 | TE | Blank-Dummy | \$191.51 | \$228.70 |
| 82-3908 | TE | Turn Lever Only | \$208.68 | \$245.88 |
| 82-3910 | TE | Lever & Turn Lever | \$210.56 | \$247.76 |
| 82-3912 | TE | Cyl. & Turn Lever | \$210.56 | \$247.76 |

| Studio Collection Inside Escutcheons | | | | 03/04/09/10/10B/10BL/ 14/15/20D/26/32/32D |
|--------------------------------------|--------|-----------------------|------------------|--|
| Part # | Design | Used for Functions | 10BE/26D/BSP/WSP | |
| 77-0062 | LE1 | Cylinder Only | \$158.72 | \$162.36 (09, 32D) |
| 77-0736 | LE1 | Blank | \$156.83 | \$160.54 (09, 32D) |
| 82-0936 | LE1 | Cylinder & Lever | \$163.62 | \$167.35 (09, 32D) |
| 82-0937 | LE1 | Lever Only | \$161.75 | \$165.48 (09, 32D) |
| 82-4594 | LB-LE1 | Turn ADA & Lever | \$189.87 | \$193.62 (09, 32D) |
| 77-2300 | LE1 | Turn Only | \$173.76 | \$177.38 (09, 32D) |
| 77-2951 | LE1 | Cylinder and Turn | \$175.56 | \$179.22 (09, 32D) |
| 82-3817 | LB-LE1 | Cylinder & Turn ADA | \$189.87 | \$193.62 (09, 32D) |
| 82-3821 | LB-LE1 | Turn ADA | \$188.02 | \$191.74 (09, 32D) |
| 82-4586 | LE1 | Turn & Lever | \$178.94 | \$182.67 |
| 82-0546 | CE | Cylinder Only | \$193.36 | \$230.55 |
| 82-0548 | CE | Blank | \$191.51 | \$228.70 |
| 82-0924 | CE | Cylinder & Lever | \$195.23 | \$232.43 |
| 82-0925 | CE | Lever Only | \$193.36 | \$230.55 |
| 82-4589 | LB-CE | Turn ADA & Lever | \$221.51 | \$258.69 |
| 82-3907 | CE | Turn Only | \$208.68 | \$245.88 |
| 82-3911 | CE | Cylinder and Turn | \$210.56 | \$247.76 |
| 82-4010 | LB-CE | Turn ADA | \$219.62 | \$256.80 |
| 82-4014 | LB-CE | Cylinder and Turn ADA | \$219.62 | \$256.80 |
| 82-4587 | CE | Turn & Lever | \$210.56 | \$247.76 |
| 82-0562 | TE | Cylinder Only | \$193.36 | \$230.55 |
| 82-0564 | TE | Blank | \$191.51 | \$228.70 |
| 82-0930 | TE | Cylinder & Lever | \$195.23 | \$232.43 |
| 82-0931 | TE | Lever Only | \$193.36 | \$230.55 |
| 82-4590 | LB-TE | Turn & Lever ADA | \$221.51 | \$258.69 |
| 82-3908 | TE | Turn Only | \$208.68 | \$245.88 |
| 82-3912 | TE | Cylinder and Turn | \$210.56 | \$247.76 |
| 82-4011 | LB-TE | Turn ADA | \$219.62 | \$256.80 |
| 82-4015 | LB-TE | Cylinder and Turn ADA | \$221.51 | \$258.69 |
| 82-4588 | TE | Turn & Lever | \$210.56 | \$247.76 |

USA & Canada Prices Effective June 3, 2019

| Outside Escutcheons Part # | Design | Used for following Functions | 10BE/26D/BSP/WSP | 03/04/09/10/10B/10BL/ 14/15/20D/26/32/32D |
|----------------------------|------------------------|-----------------------------------|------------------|--|
| 81-0552 | LE1/2/3/4 KE1/2/3/4 | Lever Only | \$158.72 | \$162.36 (09 only) |
| 81-4642 | LE1/2/3/4 KE1/2/3/4 | Knob/Lever & Emerg. Rel. | \$175.56 | \$179.22 (09 only) |
| 81-0559 | LE1/2 KE1/2 | Cyl. Only | \$160.54 | \$164.17 (09 only) |
| 81-0557 | LE1/2 KE1/2 | Knob/Lever & Cyl. | \$160.54 | \$164.17 (09 only) |
| 77-0062 | LE1/KE1 | 20 | \$158.72 | \$162.36 |
| 81-0559 | LE1/KE1 | 31-35-36 | \$160.54 | \$164.17 |
| 77-0742 | LE2/KE2 | 20 | \$158.72 | \$162.36 |
| 81-0562 | LE2/KE2 | 31-35-36 | \$160.54 | \$164.17 |
| 77-0738 | LE3/4 KE3/4 | 06-91-03-21 | \$158.72 | \$162.36 (09 only) |
| 81-0560 | LE3/4 KE3/4 | 04-05-37-70-71- 24-25-43-45-50 | \$160.54 | \$164.17 (09 only) |
| 77-1211* | LE3/KE3 | 20 | \$158.72 | \$162.36 |
| 81-0555* | LE3/KE3 | 31-35-36 | \$160.54 | \$164.17 |
| 77-1207* | LE4/KE4 | 20 | \$158.72 | \$162.36 |
| 81-0558* | LE4/KE4 | 31-35-36 | \$160.54 | \$164.17 |
| 81-0584 | LS/KS | Knob/Lever Only | \$335.64 | \$339.29 (09 only) |
| 81-4681 | LS/KS | Knob/Lever & Emerg. | \$354.34 | \$358.01 (09 only) |
| 81-0585 | LS/KS | Cyl. Only | \$335.64 | \$339.29 (09 only) |
| 81-0586 | LS/KS | Knob/Lever & Cyl. | \$339.29 | \$342.93 (09 only) |
| 81-0587 | LS/KS | Knob/Lever, Cyl., & Ind. | \$341.13 | \$342.93 (04, 10, 10B only) |
| 81-0574 | LS/KS | Blank | \$333.82 | \$337.49 (09 only) |

*Please specify finish.

| 8200 Studio Collection Outside Escutcheons Part # | Design | Used for Functions | 10BE/26D/BSP/WSP | 03/04/09/10/10B/10BL/ 14/15/20D/26/32/32D |
|---|--------|---------------------------|------------------|--|
| 77-0559 | LE1 | Cylinder Only | \$158.72 | \$162.36 |
| 82-0939 | LE1 | Cylinder & Lever | \$163.62 | \$167.35 |
| 82-0940 | LE1 | Lever Only | \$161.75 | \$165.48 |
| 82-4593 | LE1 | Lever & Emergency Release | \$178.94 | \$182.67 |
| 82-0555 | CE | Cylinder Only | \$193.36 | \$230.55 |
| 82-0927 | CE | Cylinder & Lever | \$195.23 | \$232.43 |
| 82-0928 | CE | Lever Only | \$193.36 | \$230.55 |
| 82-4584 | CE | Lever & Emergency Release | \$210.56 | \$247.76 |
| 82-0571 | TE | Cylinder Only | \$193.36 | \$230.55 |
| 82-0933 | TE | Cylinder & Lever | \$195.23 | \$232.43 |
| 82-0934 | TE | Lever Only | \$193.36 | \$230.55 |
| 82-4585 | TE | Lever & Emergency Release | \$210.56 | \$247.76 |

ML-114 MORTISE LOCKS

SARGENT®

8200/7800—OUTSIDE ESCUTCHEONS

ASSA ABLOY

USA & Canada Prices Effective June 3, 2019

| Outside Escutcheons | | Used for following Functions | 03/04/09/10/10B/10BL/ 14/15/20D/26/32/32D | |
|------------------------------------|------------|------------------------------|--|----------|
| Part # | Design | | 10BE/26D/BSP/WSP | |
| 77-3448 | LW1/KW1 | Knob/Lever Only | \$119.01 (10BE only) | \$122.73 |
| 82-1364 | LW1/KW1 | Knob/Lever Only | \$119.01 (26D only) | - |
| 77-3454 | LW1/KW1 | Knob/Lever & Emerg. Rel. | \$136.16 | \$139.94 |
| 77-3450 | LW1/KW1 | Cyl. Only | \$119.01 (10BE only) | \$122.73 |
| 82-1366 | LW1/KW1 | Cyl. Only | \$119.01 (26D only) | - |
| 77-3449 | LW1/KW1 | Knob/Lever & Cyl. | \$120.88 (10BE only) | \$124.57 |
| 82-1365 | LW1/KW1 | Knob/Lever & Cyl. | \$120.88 (26D only) | - |
| 77-3430 | LW1/KW1 | 20 | \$119.01 | \$122.73 |
| 77-5978 | LW1/KW1 | 31-35-36 | \$120.88 | \$124.57 |
| 81-0647 | WT (78/82) | Knob/Lever Only | \$111.56 | \$115.28 |
| 81-4593 | WT (78/82) | Knob/Lever & Turn Lever | \$130.62 | \$134.32 |
| 81-0651 | WT (78/82) | Cyl. Only | \$111.56 | \$115.28 |
| 81-0648 | WT (78/82) | Knob/Lever & Cyl. | \$115.28 | \$119.01 |
| 81-0646 | WT (78/82) | Blank | \$109.55 | \$113.24 |
| Outside Coastal Series Escutcheons | | | 03/04/09/10/10B/10BL/ 14/15/20D/26 | |
| Part # | Design | Used for Functions | 10BE/26D/BSP/WSP | |
| 82-0536 | CE | Lever & Cyl. | \$195.23 | \$232.43 |
| 82-0546 | CE | 20 | \$193.36 | \$230.55 |
| 82-0547 | CE | 31, 35, 36 | \$195.23 | \$232.43 |
| 82-0553 | CE | Lever Only | \$193.36 | \$230.55 |
| 82-0555 | CE | Cyl. Only | \$193.36 | \$230.55 |
| 82-3913 | CE | Lever & Emerg. Rel. | \$210.56 | \$247.76 |
| 82-0538 | TE | Lever & Cyl. | \$195.23 | \$232.43 |
| 82-0562 | TE | 20 | \$193.36 | \$230.55 |
| 82-0563 | TE | 31, 35, 36 | \$195.23 | \$232.43 |
| 82-0569 | TE | Lever Only | \$193.36 | \$230.55 |
| 82-0571 | TE | Cyl. Only | \$193.36 | \$230.55 |
| 82-3914 | TE | Lever & Emerg. Rel. | \$210.56 | \$247.76 |

| 7800/8200 Standard Rose Design (Same for inside & outside) | | | |
|--|--|------------------|--|
| Part # | Design | 10BE/26D/BSP/WSP | 03/04/09/10/10B/10BL/14/15/20D/26/32/32D |
| 695E | E | | |
| 695L | L | \$49.00 | \$56.00 |
| 695LN | LN | \$43.00 | \$47.00 |
| 695O | O | \$44.00 | \$48.00 |
| 7800/8200 Studio Collection Rose Design (Same for inside & outside) | | | |
| Part # | Design | 10BE/26D/BSP/WSP | 03/04/09/10/10B/10BL/14/15/20D/26/32/32D |
| 696LN | LN | \$43.00 | \$47.00 |
| 696CR | CR | | \$102.00 |
| 696TR | TR | \$61.00 | |
| 696O | O | \$44.00 | \$48.00 |
| 696CO | CO | | |
| 696TO | TO | \$61.00 | \$102.00 |
| 696E2 | E2 - Supplied Inside and Outside Rose | | |
| 696E3 | E3 - Supplied Inside and Outside Rose | | |
| 696E4 | E4 - Supplied Inside and Outside Rose | | |
| R8200 Collar Design (Same for inside & outside) | | | |
| Part # | Design | 10BE/26D/BSP/WSP | 03/04/09/10/10B/10BL/14/15/20D/26/32/32D |
| 697R1 | MA, ME, MF, MG, MI, MO, MU, MZ, NU | | |
| 697R2 | MJ, MQ, MS, MV, MX, MY, NJ, NS | | |
| 697R3 | MB, MD, MH, MW, ND | \$59.00 | \$100.00 |
| 697R4 | MM, G, R, S, Y | | |
| Note: Must specify lever design when ordering collar | | | |
| 7800 Emergency Release/Thumb Turns | | | |
| Part # | Design | 10BE/26D/BSP/WSP | 03/04/09/10/10B/10BL/14/15/20D/26/32/32D |
| 184W | Outside Emergency Release | \$57.00 | \$67.00 |
| 184KA | Outside Emergency Release | \$102.00 | \$111.00 |
| 126 | Thumbturn Lever (7891 & 7892 function only) | | |
| 130W | Thumbturn Lever | \$57.00 | \$67.00 |
| 8200 Emergency Release/Thumb Turns | | | |
| Part # | Design | 10BE/26D/BSP/WSP | 03/04/09/10/10B/10BL/14/15/20D/26/32/32D |
| 184KB | Outside Emergency Release | | |
| 130KB | Thumbturn Lever | | |
| 130KBT1 | Decorative T1 Thumbturn on round backplate | \$54.00 | \$57.00 |
| 130KBT2 | Decorative T2 Thumbturn on round backplate | | |
| 130KBT3 | Decorative T3 Thumbturn on round backplate | | |
| 130LB | Thumbturn Lever - Large ADA | \$70.00 | \$82.00 |
| 8200 Coastal Series Rose Design (Same for inside & outside) | | | |
| Part # | Design | 10BE/26D/BSP/WSP | 03/04/09/10/10B/10BL/14/15/20D/26/32/32D |
| 695TR | TR | \$61.00 | \$102.00 |
| 695CR | CR | | |
| 8200 Coastal Series Metro Element Emergency Release/Thumb Turns | | | |
| Part # | Design | 10BE/26D/BSP/WSP | 03/04/09/10/10B/10BL/14/15/20D/26/32/32D |
| 184KC | Outside Emergency Release - Contemporary | \$61.00 | \$67.00 |
| 184KT | Outside Emergency Release - Traditional | | |
| 130KC | Thumbturn Lever - Contemporary | | |
| 130KCT1 | Dec. T1 Thumbturn on contemporary backplate | \$61.00 | \$67.00 |
| 130KCT2 | Dec. T2 Thumbturn on contemporary backplate | | |
| 130KCT3 | Dec. T3 Thumbturn on contemporary backplate | | |
| 130KT | Thumbturn Lever - Traditional | | |
| 130KTT1 | Dec. T1 Thumbturn on traditional backplate | \$61.00 | \$67.00 |
| 130KTT2 | Dec. T2 Thumbturn on traditional backplate | | |
| 130KTT3 | Dec. T3 Thumbturn on traditional backplate | | |
| 130LC | Thumbturn Lever - Large ADA - Contemporary | \$82.00 | \$90.00 |
| 130LT | Thumbturn ADA version | | |
| 130KA | Thumbturn Lever - Used with E Rose | | |
| 130KAT1 | Dec. T1 Thumbturn on square backplate | \$192.00 | \$212.00 |
| 130KAT2 | Dec. T2 Thumbturn on square backplate | | |
| 130KAT3 | Dec. T3 Thumbturn on square backplate | | |
| 7800/8200 Indicators | | | |
| Part # | Design | 10BE/26D/BSP/WSP | 03/04/09/10/10B/10BL/14/15/20D/26/32/32D |
| 185C | Visual Indicator (49-) | \$93.00 | \$102.00 |
| Note: Used with 30, 36, 37 function | | | |
| - 7800 & 8200 Rose Trims: CR, L, LN, TR, E, O Used with 26, 29, 38, 39, 40, 41 function - Rose Trim 8200 LN | | | |
| 185P | Occupancy Indicator (49-) | \$93.00 | \$102.00 |
| Note: Used with 65, 66, 68 functions Rose Trim 7800 & 8200 CR, E, L, LN, O, TR | | | |
| 185S-1 | Secured Indicator Rose (1-3/8" thick door) (50-) | | |
| 185S-2 | Secured Indicator Rose (1-3/4" thick door) (50-) | \$109.00 | \$123.00 |
| 185S-3 | Secured Indicator Rose (2" thick door) (50-) | | |
| 185S-4 | Secured Indicator Rose (2-1/4" thick door) (50-) | | |
| Note: Used with 24, 25, 26, 28, 29, 30, 36, 37, 38, 39, 40, 41, 43, 45, 50, 51, 52, 67 functions - all Rose type trims only. | | | |
| Note: When ordering with lock, specify 49 or 50 option. | | | |

ML-116 MORTISE LOCKS

SARGENT®

ASSA ABLOY

7800/8200 – MOUNTING KITS

USA & Canada Prices Effective June 3, 2019

7800/8200 Anti-Vandal Pull trims – Available with all Trims except LS/KS, FE, PT

| Part # | Description | 32D |
|--------|--|----------|
| 667-1 | RHRB Pull for 04, 06, 17, 28, 29, 30, 31, 50, 51, 52, 91, 92 functions | |
| 667-2 | LHRB Pull for 04, 06, 17, 28, 29, 30, 31, 50, 51, 52, 91, 92 functions | |
| 667-3 | RHRB Pull for 03, 20, 21, 22, 23 functions | |
| 667-4 | LHRB Pull for 03, 20, 21, 22, 23 functions | \$466.00 |
| 667-5 | RHRB Pull without Lip for inactive door | |
| 667-6 | LHRB Pull without Lip for inactive door | |

Note: When ordering with lock, specify AV option.

8200 Inside Trim Kit (04/05/15/16/17/24/25/26/37/43/45/50/65/66/70/71/72/73/85/86/94 functions)

| Part # | Description | Price |
|---------|--|---------|
| 82-3212 | CE, KS, LE (1-4), TE, LS - 1 3/4", 2" Door | \$50.53 |
| 82-3873 | CE, KS, LE (1-4), TE, LS - 2 1/4" Door | \$61.36 |
| 82-3211 | CR, TR, LN, LW1, O - 1 3/4", 2" Door | \$50.53 |
| 82-3874 | CR, TR, LN, LW1, O - 2 1/4" Door | \$61.36 |
| 82-3213 | L, WT - 1 3/4", 2" Door | \$51.37 |
| 82-3875 | L, WT - 2 1/4" Door | \$61.36 |

8200 One-Side Trim Kit (06/13/31/35/36/91/92/95 functions)

| Part # | Description | Price |
|---------|---|---------|
| 82-3208 | LN, E, O, CR, TR Rose/LW1, KW1 Esc. - 1 3/4" Door | \$54.61 |
| 82-3209 | LE, KE (1,2,3,4), CE, TE Esc. - 1 3/4" Door | \$55.64 |
| 82-3210 | L Rose, WT Esc. - 1 3/4" Door | \$56.44 |
| 82-3214 | LS, KS - 1 3/4" Door | \$52.55 |

8200 Outside Trim Kit

| Part # | Description | Price |
|---------|--|---------|
| 82-3876 | CE, KS, LE (1-4), TE, LS - 1 3/4" Door | \$26.03 |
| 82-3877 | CE, KS, LE (1-4), TE, LS - 2" Door | \$31.62 |
| 82-3878 | CE, KS, LE (1-4), TE, LS - 2 1/4" Door | \$35.35 |
| 82-3879 | CR, TR, LN, LW1, O - 1 3/4" Door | \$26.03 |
| 82-3880 | CR, TR, LN, LW1, O - 2" Door | \$31.62 |
| 82-3881 | CR, TR, LN, LW1, O - 2 1/4" Door | \$35.35 |
| 82-3882 | L, WT - 1 3/4" Door | \$26.03 |
| 82-3883 | L, WT - 2" Door | \$31.62 |
| 82-3884 | L, WT - 2 1/4" Door | \$35.35 |

8200 Complete Trim Kit

| Part # | Description | Price |
|---------|--|---------|
| 82-3885 | CE, KS, LE (1-4), TE, LS - 1 3/4" Door | \$76.24 |
| 82-3886 | CE, KS, LE (1-4), TE, LS - 2" Door | \$81.82 |
| 82-3887 | CE, KS, LE (1-4), TE, LS - 2 1/4" Door | \$96.70 |
| 82-3888 | CR, TR, LN, LW1, O - 1 3/4" Door | \$76.24 |
| 82-3889 | CR, TR, LN, LW1, O - 2" Door | \$81.82 |
| 82-3890 | CR, TR, LN, LW1, O - 2 1/4" Door | \$96.70 |
| 82-3891 | L, WT - 1 3/4" Door | \$76.24 |
| 82-3892 | L, WT - 2" Door | \$81.82 |
| 82-3893 | L, WT - 2 1/4" Door | \$96.70 |

8200 10 Pack - Complete Trim Kit

| Part # | Description | Price |
|---------|--|----------|
| 82-3894 | CE, KS, LE (1-4), TE, LS - 1 3/4" Door | \$762.33 |
| 82-3895 | CE, KS, LE (1-4), TE, LS - 2" Door | \$818.11 |
| 82-3896 | CE, KS, LE (1-4), TE, LS - 2 1/4" Door | \$966.85 |
| 82-3897 | CR, TR, LN, LW1, O - 1 3/4" Door | \$762.33 |
| 82-3898 | CR, TR, LN, LW1, O - 2" Door | \$818.11 |
| 82-3899 | CR, TR, LN, LW1, O - 2 1/4" Door | \$966.85 |
| 82-3900 | L, WT - 1 3/4" Door | \$762.33 |
| 82-3901 | L, WT - 2" Door | \$818.11 |
| 82-3902 | L, WT - 2 1/4" Door | \$966.85 |

8200 Studio Collection Inside trim Kit (04, 05, 15, 16, 17, 24, 25, 26, 37, 43, 45, 50, 65, 66, 70, 71, 72, 83, 85, 86, 94 functions)

| Part # | Rose/Eschutcheon Description | Price |
|---------|--|---------|
| 79-2162 | O,CO,CR,LN,TO,TR Roses and LW1, WT Escutcheons | \$27.51 |

8200 Studio Collection One Side Trim Kit (06,13,31,35,36,91,92,95 functions)

| Part # | Rose/Eschutcheon Description | Price |
|---------|--|---------|
| 79-2161 | O,CO,CR,LN,TO,TR Roses and LW1, WT Escutcheons | \$41.33 |
| 79-2159 | O,CO,CR,LN,TO,TR (93 function only) | \$28.67 |
| 79-2160 | O,CO,CR,LN,TO,TR (94 function only) | \$28.96 |

USA & Canada Prices Effective June 3, 2019

| Strikes Part # | | Price |
|-------------------|---|----------------|
| 77-1141 | Wrought Box (Steel) ord'rd w/locks | N/A |
| 77-1141 | Wrought Box (Steel) ordered separately | \$10.80 |
| 78-0034 | Deadlock Strike - No Lip | \$21.00 |
| 82-0229 | Straight Lip Strike - 7/8" Lip | \$26.00 |
| 82-0109 | Curved Lip Strike - 1 1/8" | \$26.00 |
| 82-0110 | Curved Lip Strike 1 1/4" Lip Length-Standard | \$26.00 |
| 82-0111 | Curved Lip Strike 1 3/8" Lip Length | \$26.00 |
| 82-0112 | Curved Lip Strike 1 5/8" Lip Length | \$26.00 |
| 82-0113 | Curved Lip Strike 1 7/8" Lip Length | \$26.00 |
| 82-0114 | Curved Lip Strike 2 1/8" Lip Length | \$26.00 |
| 82-0115 | Curved Lip Strike 2 3/8" Lip Length | \$26.00 |
| 82-0116 | Curved Lip Strike 2 5/8" Lip Length | \$26.00 |
| 82-0117 | Curved Lip Strike 2 7/8" Lip Length | \$26.00 |

| 877 Back Strikes Part # | | Price |
|----------------------------|----------------------------|----------|
| 82-0332 | RHRB - 1 3/4" Dr Thickness | \$109.00 |
| 82-0333 | LHRB - 1 3/4" Dr Thickness | \$109.00 |
| 82-0334 | RHRB - 2" Dr Thickness | \$125.00 |
| 82-0335 | LHRB - 2" Dr Thickness | \$125.00 |
| 82-0336 | RHRB - 2 1/4" Dr Thickness | \$135.00 |
| 82-0337 | LHRB - 2 1/4" Dr Thickness | \$135.00 |
| 82-0338 | RHRB - 2 1/2" Dr Thickness | \$148.00 |
| 82-0339 | LHRB - 2 1/2" Dr Thickness | \$148.00 |
| 82-0340 | RHRB - 2 3/4" Dr Thickness | \$159.00 |
| 82-0341 | LHRB - 2 3/4" Dr Thickness | \$159.00 |
| 82-0342 | RHRB - 3" Dr Thickness | \$171.00 |
| 82-0343 | LHRB - 3" Dr Thickness | \$171.00 |

Note: Lock must be centered in door.

| 7800-8200 - Rabbeted Front Kit - Function required when ordering | | | |
|--|------------------------|----------|-------------------------------|
| Part # | Design | 26D | 03/04/09/10/10BL/14/15/20D/26 |
| 677 | for 1 3/4" to 2" Doors | \$185.00 | \$211.00 |
| 2-677 | for 2 1/4" Doors | \$185.00 | \$211.00 |

| 8100 Spindle Kits (Ball & Socket) | | | |
|--|------------------|----------------|---------|
| Kit Number | Rose/Esc. Design | Door Thickness | Price |
| Spindle Kits for 8100's mfg. prior to 1/1/90 | | | |
| 578-1 | LN, LE, LW | 1-3/8" | \$38.00 |
| 578-2 | LN, LE, LW | 1-3/4" | \$38.00 |
| 578-3 | LN, LE, LW | 2-1/4" | \$38.00 |
| Spindle Kits for 30-8100 mfg. after 1/1/90 | | | |
| 579-1 | LN, LE, LW | 1-3/8" | \$38.00 |
| 579-2 | LN, LE, LW | 1-3/4" | \$38.00 |
| 579-3 | LN, LE, LW | 2-1/4" | \$38.00 |

Kit includes: Pre-drilled spindle assembly, 2 grub screws, 2 bushings, spiral pin, spindle cavity template.
Please specify door thickness, rose or escutcheon and lever or knob design.

| 8100 Thru-Bolt Spindles | | Price |
|-------------------------|--|---------|
| 10-0195 | Inside Spring, Outside Spring | \$0.79 |
| 81-0618 | For 1-3/8" Door – Inside/Outside Spindle | \$33.81 |
| 81-0524 | For 1-3/4" Door – Inside/Outside Spindle | \$33.81 |
| 81-0619 | For 2-1/4" Door – Inside/Outside Spindle | \$33.81 |

ML-118 MORTISE LOCKS

8200/7800 PARTS

USA & Canada Prices Effective June 3, 2019

SARGENT®

ASSA ABLOY

| Part No. | | Price |
|----------|--|--------|
| 01-0010 | PT-Trim Retaining Ring | \$0.85 |
| 01-0079 | Washer/Shim - Inside & Outside | \$0.85 |
| 01-0203 | Retaining Ring (for deadbolt & assy.) | \$0.85 |
| 01-0972 | PT-Trim Cotter Pin | \$2.19 |
| *01-1019 | 12-24 x 1/2 PH Screw (for strikes) | \$0.78 |
| *01-1028 | 8-32 x 1/4 PH Screw (for O/S fronts) | \$0.77 |
| 01-1071 | Mounting Screws for 130/184 KA, KB, KC, KT, LB, LC, LT (MS) | \$1.21 |
| *01-1119 | Machine Screw #8-82 x 1 1/2" PH HD | \$1.45 |
| *01-1154 | Screw for 130/184 KA, KB, KC, KT, LB, LC, LT (#6-32 x 1/4") | \$1.39 |
| 01-1161 | Set Screw | \$0.89 |
| 01-1174 | Lever/Knob Screw for B/J/L/P/W/C/G/R/S/Y Lever-B/C Knob | \$2.78 |
| *01-1257 | #8-32 x 3/4 CS FL Spanner | \$8.36 |
| *01-1261 | #6-32 x 5/16 FT MS Spanner | \$5.75 |
| *01-1262 | 6-32 x 1/4 FT MS Spanner | \$5.75 |
| *01-1272 | 6-32 x 3/8 FL MS Spanner | \$4.24 |
| *01-1273 | 8-32 x 1/4 FL MS Spanner | \$4.11 |
| *01-1282 | 12-24 x 1/2 FL MS Spanner | \$4.25 |
| *01-1283 | #12 x 1" FT WS Spanner | \$5.34 |
| *01-1285 | 1/4-20 x 1 3/4 MS Spanner | \$7.43 |
| *01-1290 | 1/4-20 x 2" MS Spanner | \$7.65 |
| *01-1362 | #8-32 x 3/4 CS Flt Torx | \$3.23 |
| *01-1366 | #6-32 x 5/16 FT MS Torx | \$4.05 |
| *01-1367 | #6-32 x 1/4 FT MS Torx | \$4.39 |
| *01-1377 | PT-Trim Torx Screw | \$6.33 |
| *01-1378 | #8-32 x 1/4 FTMS Torx | \$5.98 |
| *01-1387 | #12-24 x 1/2 FTMS Torx | \$4.24 |
| *01-1388 | #12 x 1 FT wood screw | \$7.03 |
| *01-1390 | 1/4 - 20 x 1 1/4 MS Flt Torx | \$6.75 |
| *01-1395 | 1/4 - 20 x 2 MS Flt Torx | \$7.08 |
| *01-1472 | Lever/Knob Screw for A/E/F Lever | \$2.78 |
| 01-1489 | FW-Trim Screw & Washer - #10-32 5/16" | \$0.86 |
| 01-1491 | 6 x 3/8" wood screw | \$0.19 |
| 01-1495 | Thru-bolt Screws – All Trims | \$0.85 |
| *01-2034 | 6 x 3/8" PH wood screw | \$0.85 |
| *01-2035 | 6 x 1/2" PH wood screw | \$0.85 |
| *01-2037 | 6 x 3/4" PH wood screw | \$1.62 |
| 01-2217 | Mounting Screws for 130/184 W (WS) | \$1.26 |
| *01-2298 | #12 x 1 1/4" wood screw (for strike) | \$0.73 |
| 01-2299 | #12 x 1 1/4" wood screw (for lockbody) | \$0.43 |
| *01-3151 | Screw for 130/184 W (#6-32 x 5/16") | \$1.20 |
| 01-3157 | 6-32 x 3/4" PH M.S. | \$1.20 |
| *01-3457 | 1/4 - 20 x 2 PH | \$1.21 |
| 01-4370 | Screw for 130/184 KA, KB, KC, KT, LB, LC, LT (#6-32 x 5/16") | \$0.36 |

*Specify finish required.

| Part No. | | Price |
|----------|---|----------|
| 01-4376 | Screw for hold cable clamp | \$0.59 |
| 01-4402 | 8-32 x 5/16" Machine Screw | \$0.49 |
| *01-4405 | Lever/Knob Screw – Torx – A/E/F | \$4.25 |
| 01-4457 | FW-Trim Cap Screw #10-32 x 3/8" (hex hd) | \$4.92 |
| 01-4510 | PT-Trim Truss Head M.S. 12-24 x 1/4" | \$2.19 |
| 01-4511 | Flt. Hd. Mach Screw 12-24 x 1-7/8" | \$2.19 |
| 01-4532 | Self Tapping Screw | \$0.84 |
| *01-5000 | Machine Screw (LE2, LE4 Esc.) | \$0.81 |
| 01-9180 | Catch Screw | \$0.27 |
| 06-0183 | Escutcheon spring clip | \$20.06 |
| 06-0216 | Sitker (escutcheon clip) | \$0.52 |
| 14-0057 | Emergency Key (65 function) | \$1.68 |
| 52-2647 | Switch & Bracket Assy (LX) | \$133.41 |
| 77-0166 | 8-32 x 2-3/4 PH FL HD LG ES | \$13.45 |
| *77-0168 | Machine Screw (LE1 Esc.) | \$1.57 |
| 77-0258 | Neoprene Washer | \$0.30 |
| 77-0734 | Bushing Locator | \$5.37 |
| 77-1467 | 8-32 x 2" PH Screw | \$2.11 |
| 77-2744 | Esc. Screw Pk LE/KE (2,4) Trim One Side | \$10.16 |
| *77-3467 | Esc. Screw Pk LE/KE (2,4) 1 3/8" Door | \$11.27 |
| *77-3468 | Esc. Screw Pk LE/KE (2,4) 1 3/4" Door | \$11.52 |
| *77-3469 | Esc. Screw Pk LE/KE (2,4) 2" Door | \$12.68 |
| *77-3470 | Esc. Screw Pk LE/KE (2,4) 2 1/4" Door | \$20.02 |
| 77-3886 | Spindle assy (knb set) 30-77 | \$21.49 |
| *77-4158 | Esc. Screw Pk LE/KE(1,3), LW1/KW1, CE, TE - Trim One Side | \$4.44 |
| *77-4230 | Cyl. Ret. Cap Pack | \$60.17 |
| *77-4236 | Standard Screw Pack for Strike, Front & Lockbody | \$5.48 |
| *77-4251 | Esc. Screw Pk LS - 1 3/4" Door | \$21.95 |
| 78-0007 | Latch Lever (7800 only) | \$10.99 |
| 78-0008 | Non-handed Hub (7800 only) | \$18.04 |
| 78-0009 | Hub Spacer (7800 only) | \$2.68 |
| 78-0140 | T-Handle Hub Spacer | \$18.04 |
| 78-0286 | Spacer Stop | \$2.46 |
| 78-0292 | Retaining Nut only (for WT and Rose trim only) | \$15.59 |
| 78-2749 | Rose Nut & Wrench Pack (Rose Trim) | \$12.23 |
| *81-0067 | FW-Trim Washer (disk) 04,17,31,50,70, 73 only | \$10.49 |
| 81-0641 | Thrubolts - specify door thickness when ordering | \$10.04 |
| 81-0723 | Thrubolt Posts (1 3/4" Door) | \$1.90 |
| *81-2262 | Plug Assy for 93 & 94 function | \$65.07 |
| 81-4270 | Lever Adpt & Screw pk (E,L) | \$12.70 |
| 81-4443 | Adapter & Plate Assy (LN) | \$12.85 |
| *82-0009 | 3P-8225 O/S Front | \$137.85 |

USA & Canada Prices Effective June 3, 2019

| Part No. | | Price |
|----------|--|----------|
| 82-0017 | Mntg Post - 1 3/8" Door | \$3.23 |
| *82-0080 | O/S Front (15, 65) | \$48.18 |
| *82-0081 | O/S Front (04, 05, 06, 13, 16, 17, 31, 36, 37, 38, 56, 67) | \$48.18 |
| *82-0082 | O/S Front (03, 20, 21, 22, 23, 28, 29, 30) | \$48.18 |
| *82-0083 | O/S Front (24, 25, 26, 27, 35, 39, 66, 68) | \$48.18 |
| *82-0084 | O/S Front (50, 40, 41, 51, 52) | \$48.18 |
| *82-0085 | O/S Front (55) | \$48.18 |
| *82-0086 | O/S Front (45, 46, 47, 48) | \$48.18 |
| *82-0087 | O/S Front (43) | \$48.18 |
| *82-0088 | O/S Front (89, 90, 91, 92) | \$48.18 |
| 82-0101 | Toggle Button (05, 43, 45, 85) | \$13.96 |
| 82-0102 | Toggle Spring (05, 43, 45, 85) | \$1.53 |
| 82-0103 | Guard Lever Arm | \$7.08 |
| 82-0120 | Hub (spacer) | \$2.56 |
| 82-0123 | Hub (cap 92 function) | \$69.48 |
| 82-0124 | Hub (case 92 function) | \$69.48 |
| 82-0127 | Spacer 1/2" (04, 05, 06, 16, 17, 91, 92) | \$0.85 |
| 82-0128 | Spacer 7/16" (41, 43, 45, 50) | \$0.85 |
| 82-0132 | Auto Lock Lever | \$4.62 |
| 82-0133 | Auto Retract Lever | \$4.62 |
| 82-0138 | Guard Lever Spring (all functions) | \$1.53 |
| 82-0139 | Cylinder Latch Lever (04, 06, 16, 37, 31) | \$9.66 |
| 82-0144 | Deadbolt Spring (03, 20, 21, 22, 23, 24) | \$4.92 |
| 82-0149 | Hub Core (for thumbturn) | \$13.05 |
| 82-0160 | Cyl. Latch Lever | \$4.24 |
| 82-0161 | Spring (classroom) | \$8.36 |
| 82-0163 | Anti-Vandal Hub | \$3.05 |
| 82-0168 | Classroom Hub (for thumbturn) | \$15.39 |
| 82-0170 | Washer | \$2.04 |
| 82-0171 | Plastic Spacer | \$1.03 |
| 82-0184 | Retaining Nut/Cap Nut - Outside | \$7.10 |
| 82-0202 | FW-Trim Adapter Only - I/S Lever | \$15.39 |
| 82-0203 | FW-Trim Adapter Only - I/S Knob | \$15.39 |
| 82-0208 | Lead Lining (lockbody sleeve) | \$502.04 |
| 82-0211 | Locking Piece Jamb (04, 17, 31, 50) | \$7.27 |
| 82-0212 | Toggle Button Washer - 2 per lock | \$1.20 |
| *82-0235 | 1-Option O/S Front (15, 65) | \$48.18 |
| *82-0236 | 1-Option O/S Front (04, 05, 06, 13, 16, 17, 31, 36, 37, 38, 56, 67,) | \$48.18 |
| *82-0237 | 1-Option O/S Front (03, 20, 21, 22, 23, 28, 29, 30) | \$48.18 |
| *82-0238 | 1-Option O/S Front (24, 25, 26, 27, 35, 39, 66, 68) | \$48.18 |
| *82-0239 | 1-Option O/S Front (40, 41, 50, 51, 52, 97) | \$48.18 |
| *82-0240 | 1-Option O/S Front (55) | \$48.18 |
| *82-0241 | 1-Option O/S Front (45, 46, 47, 48) | \$48.18 |

| Part No. | | Price |
|----------|---|----------|
| *82-0242 | 1-Option O/S Front (43) | \$48.18 |
| 82-0251 | Washer | \$1.03 |
| 82-0347 | Lever Spring (put into lever handle)' | \$0.85 |
| 82-0367 | Spindle for 1-3/8" dr. | \$9.30 |
| 82-0368 | Spindle for 1-3/4" dr(stndrd) | \$9.30 |
| 82-0369 | Spindle for 2-1/8" dr. | \$9.98 |
| 82-0370 | Spindle for 2-1/2" dr. | \$9.98 |
| 82-0392 | Spring Guide (for guard bolt) | \$1.20 |
| 82-0393 | Spring (for guard bolt) | \$1.68 |
| 82-0396 | Spindle for 93 function - 1-3/4"-2" dr. | \$9.46 |
| 82-0397 | STR.Spindle (2-1/8-2 - 3/8") | \$9.46 |
| 82-0399 | Spindle for 94 function - 1-3/4"-2" dr. | \$9.46 |
| 82-0406 | Half Cable Clamp (70, 71, 72, 73) | \$0.92 |
| 82-0408 | Cylinder Latch Lever | \$0.85 |
| 82-0421 | Hub (case - 8200) | \$17.27 |
| 82-0422 | Hub (cap - 8200) | \$17.27 |
| 82-0454 | FW-Trim Spacer | \$0.60 |
| 82-0455 | FW-Trim Mounting Plate | \$34.14 |
| 82-0456 | FW-Trim Thrubolt Stud - (1-3/8" Door) | \$18.74 |
| 82-0457 | FW-Trim Bushing Insert | \$7.27 |
| *82-0458 | FW-Trim O/S Esc. Only-All functions exc. 65,66 | \$204.91 |
| 82-0459 | FW-Trim Spindle Stud - O/S (04,17,31,50, 71,13) | \$6.24 |
| 82-0509 | Deadbolt Spring (8285) | \$22.32 |
| 82-0539 | Mntg Post - 2 1/4" Door | \$5.21 |
| 82-0541 | Spring Bracket | \$13.96 |
| 82-0542 | Friction Disc | \$12.08 |
| *82-0578 | O/S Front (70, 71, 72, 73) | \$48.18 |
| *82-0587 | 1- O/S Front (89, 90, 91, 92) | \$48.18 |
| *82-0588 | 1- O/S Front (70, 71, 72, 73) | \$48.18 |
| 82-0612 | Rose Wave Spring | \$0.84 |
| 82-0617 | Latch bolt rod | \$1.09 |
| 82-0632 | Rod support | \$27.20 |
| 82-0627 | O/S Front (95, 96, 97) | \$32.83 |
| 82-0633 | LB Tail Clip (65) | \$1.59 |
| 82-0691 | Outside bushing | \$12.56 |
| 82-1038 | Lever locking set screw | \$1.88 |
| 82-1471 | Spindle (2-1/4" door) | \$2.24 |
| 82-2004 | Spring Cartridge Assembly (8200) | \$17.43 |
| 82-2029 | Guardbolt Assembly - guarded function | \$7.27 |
| 82-2121 | Fire Stop Assembly - all functions | \$14.71 |
| 82-2122 | Cylinder Retainer Assy. (cyl. functions) | \$8.63 |
| 82-3082 | Mntg Plate - LN, E, O, CR, TR Rose; LW1, KW1 Esc. | \$9.30 |
| 82-3085 | Mntg Plate - LE/KE(1-4), CE, TE, LS, KS Esc. | \$9.30 |

ML-120 MORTISE LOCKS

8200/7800 PARTS

USA & Canada Prices Effective June 3, 2019

SARGENT®

ASSA ABLOY

| Part No. | | Price |
|----------|--|----------|
| 82-3088 | I/S Plate & Adapter-LN, O, E - Rose/LW1 Esc. | \$25.36 |
| 82-3089 | I/S Plate & Adapter-L Rose/WT Esc. | \$35.86 |
| 82-3090 | I/S Plate & Adapter-LE/KW(1,2,3,4), CE, TE, LS Esc. | \$48.52 |
| 82-3092 | Locking Piece Assy. Lock One Lever | \$10.98 |
| 82-3093 | Locking Piece Assy. Lock Both Levers | \$9.66 |
| 82-3217 | Mntg Plate - L Rose, WT Esc. | \$9.30 |
| 82-3341 | Esc. Screw Pk LE/KE(1,3), LW1/KW1, CE1, TE1 - 1 3/4" Door | \$24.15 |
| 82-3618 | Locking Piece (72, 73) | \$25.10 |
| 82-3645 | 68/69 -8200 spring ctg asy | \$10.86 |
| 82-3654 | Esc. Screw Pk WT - Wood/Metal Door | \$7.27 |
| 82-3657 | Anti-Vandal Hub Pack | \$19.96 |
| 82-3662 | Interlocking Assy. | \$111.07 |
| 82-3663 | FW-Interlocking Assy (37 function) | \$111.07 |
| 82-3664 | FW-Interlocking Assy (65,66 functions) | \$111.07 |
| 82-3670 | Spindle & Locking Hub | \$49.54 |
| 82-3671 | FW-Spindle (split) Assy - 37 function | \$49.54 |
| 82-3672 | FW-Spindle (split) Assy - 65,66 function | \$49.54 |
| 82-3675 | Escutcheon Screws 1/4-20 x 1 3/4" | \$2.04 |
| 82-3676 | Escutcheon Screws 1/4-20 x 2" | \$2.78 |
| *82-3677 | FW-O/S Esc. Only- 65,66 functions | \$291.25 |
| 82-3690 | Esc. Screw Pack LE/KE(1,3), LW1/KW1, CE1, TE1 - 1 3/8" Door | \$22.11 |
| 82-3691 | Esc. Screw Pk LE/KE(1,3), LW1/KW1, CE1, TE1 - 2" Door | \$25.10 |
| 82-3692 | Esc. Screw Pk LE/KE(1,3), LW1/KW1, CE1, TE1 - 2 1/4" Door | \$32.12 |
| 82-3693 | Esc. Screw Pk LS - 2" Door | \$22.98 |
| 82-3694 | Esc. Screw Pk LS - 2 1/4" Door | \$29.93 |
| 82-3736 | 3P-Fix Device | \$147.70 |
| *82-4022 | Thru Bolt Blank Dummy Plate Assy - 1 3/8" Dr. | \$43.65 |
| *82-4023 | Thru Bolt Blank Dummy Plate Assy - 1 3/4" Dr. | \$43.65 |
| *82-4024 | Thru Bolt Blank Dummy Plate Assy - 2" Dr. | \$47.70 |
| *82-4025 | Thru Bolt Blank Dummy Plate Assy - 2 1/4" Dr. | \$43.65 |
| 82-4051 | VAC/OCC Slide asy | \$12.76 |
| 82-4052 | Thumb turn screw pack -for all thumb turn designs (includes: mountig plate, mounting screws (2), and finish screw. | \$8.02 |
| 82-4180 | Deadbolt asy | \$39.81 |
| 82-4248 | Adaptor plate & post asy | \$11.13 |

| Part No. | | Price |
|----------|---|---------|
| 82-4576 | Outside adapter & plate assembly for CO, CR, LN, O, TO, TR | \$4.62 |
| 82-4577 | Inside adapter & plate assembly or CO, CR, LN, O, TO, TR | \$16.92 |
| 82-4595 | Outside adapter & plate assembly for CE, LE1, TE escutcheons | \$4.62 |
| 82-4596 | Inside adapter & plate assembly for CE, LE1, TE escutcheons | \$16.91 |
| 82-4600 | Trim Pack GBT (2 Sides) Studio | \$28.83 |
| 82-4611 | Trim 1 side pack | \$23.16 |
| 82-4675 | R82 Mounting plate and bushing asy | \$36.12 |
| 97-0478 | FW-Lower Plate | \$5.03 |

*Specify finish required.

ASSA ABLOY, the global leader
in door opening solutions

Copyright © 2002-2019 Sargent Manufacturing Company, an ASSA ABLOY Group company. All rights reserved.
Reproduction in whole or in part without the express written permission of Sargent Manufacturing Company is prohibited.
Contact us at: 800-727-5477 or visit www.sargentlock.com. In Canada contact us at: 800-461-3007 or visit www.assaabloydss.ca

How to Order

| Step | Description | Example |
|---|--|--|
| Quantity | Each | 10 Ea. |
| Option | Consult catalog for options available | 10 Ea. 75- |
| Product Series | 7900 Levers and Knobs | 10 Ea. 75-79 |
| Function | Consult catalog for functions available | 10 Ea. 75-7955 |
| Trim | Consult catalog for trims available | 10 Ea. 75-7955 OBL |
| Finish | Consult catalog for finishes available | 10 Ea. 75-7955 OBL US26D |
| Hand | Consult catalog for handing requirements | 10 Ea. 75-7955 OBL US26D RH |
| Options | Consult factory for options available | 10 Ea. 75-7955 OBL US26D RH x 1 3/8" Lip Strike |
| When ordering split finishes specify outside finish first | | 10 Ea. 75-7955 OBL US3 x US26D RH |

To price split trim/finish, defaults to higher price.

Locksets in combinations not listed should be figured by adding together the prices of the component parts.

If by any method of figuring, lower prices can be obtained than set prices shown, set prices will prevail.

It is not permissible to take full deduction for omission of a component from a lockset.

Prices are for 1-3/4" door. For other door thicknesses not listed herein, please consult factory.

ANSI Finish and Function Comparison

| Function | | Finish | | |
|----------|------|---------|------|---|
| SARGENT | ANSI | SARGENT | ANSI | Description |
| 15 | F01 | US3 | 605 | Polished brass, clear coated |
| 55 | F04 | US4 | 606 | Satin brass, clear coated |
| 37 | F05 | US9 | 611 | Polished bronze, clear coated |
| 04 | F07 | US10 | 612 | Satin Bronze, clear coated |
| 16 | F09 | US10B | 613 | Oxidized Satin Bronze/Oil Rubbed |
| 45 | F12 | US10BE | 613E | Dark Oxidized Satin Bronze - Equivalent |
| 25 | F13 | US10BL | --- | Oxidized Satin Bronze, clear coated |
| 26 | F14 | US15 | 619 | Satin nickel, clear coated |
| 50 | F15 | US14 | 618 | Bright nickel, clear coated |
| 66 | F19 | US20D | --- | Statuary dark bronze, clear coated |
| 43 | F20 | US26 | 625 | Polished chrome |
| 24 | F21 | US26D | 626 | Satin chrome |
| 65 | F22 | US32 | 629 | Polished stainless steel |
| 38 | F32 | US32D | 630 | Satin stainless steel |

ML-122 MORTISE LOCKS

SARGENT®

ASSA ABLOY

OPTIONS

USA & Canada Prices Effective June 3, 2019

| Options | Description | Price |
|----------|---|--|
| 1▲ | 7900 Line with 1-1/16" wide front for 1-3/8" doors. | \$58.00 |
| 10▲ | SARGENT Signature Key System | \$58.00 / cyl. |
| 11†▲ | SARGENT XC Key System (not available with 10, 22, SC, SE options) | No addition |
| 1160 | SARGENT XC Large Format Interchangeable Plastic Disposable Construction Core | No addition |
| 1163 | SARGENT XC Large Format Interchangeable Core Cylinder - Includes masterkeying charges | \$77.00 |
| 1164 | SARGENT XC Large Format Interchangeable Construction Core Cylinder | \$77.00 |
| 1170 | Small Format interchangeable disposable construction core - to accept 7 Pin XC permanent core | No addition |
| 11727P | Small Format interchangeable keyed construction core - to accept 7 Pin XC permanent core | \$69.00 |
| 11737P | Small Format interchangeable core - to accept 7 pin XC permanent core | \$69.00 / cyl. |
| 21▲† | SARGENT Construction Key System (lost ball) Standard on all new systems established since 5/1/96 | \$16.00 / cyl. |
| 22▲† | SARGENT Construction Key System (split key) To be used on pre-established split key systems only | \$32.00 / cyl. |
| 31 | Thick Doors - Extended Lip Required - Specify Length C to E - Cylinders - IMPORTANT- See catalog 7800/8200 option page for cylinder limitations - Below charges DO NOT include additional charges for special cylinder requirements | |
| | Doors up to 2-1/2" thick - lock centered | No addition |
| | Doors 2-5/8" to 6" thick OR doors 1-3/4" thick w/max 1" paneling one side. For example: Specify 1-3/4" door with panel (Side) on inside or outside | Non Keyed function \$50.00 Keyed function \$100.00 |
| 36 | 6 Lobe security head screws | \$23.00 |
| 37 | Spanner head screws | \$16.00 |
| 60 | SARGENT Large Format Interchangeable Plastic Disposable Construction Core | No addition |
| 63 | SARGENT Large Format Interchangeable core cylinder, includes master keying charges | \$77.00 / cyl. |
| 64 | SARGENT Large Format Interchangeable Construction Core Cylinder | \$77.00 |
| 6573▲† | Small Format 6-Pin Uncombined Core (Refer to CK-12) | \$59.00 / cyl. |
| 65737P▲† | Small Format 7-Pin Uncombined Core (Refer to CK-12) | \$59.00 / cyl. |
| 68 | 7900 Line furnished with lever handle outside x knob inside | Defaults to 7900 Lever Lock Price |
| 69 | 7900 Line furnished with lever handle inside x knob outside | Defaults to 7900 Lever Lock Price |
| 70▲† | Small Format Interchangeable disposable plastic construction core | No addition |
| 72▲† | Small Format Interchangeable 6-pin construction core (7-pin with 11 options) | \$69.00 |
| 73▲† | Small Format interchangeable core 6-pin Includes MK and GMK keying charges | \$69.00 / cyl |
| 737P▲† | Small Format interchangeable core 7-pin (refer to CK-12 for available keyways) Includes MK and GMK keying charges | \$69.00 / cyl |
| 75 | Tactile Warning - Milled Inside Lever | \$72.00 |
| 76 | Tactile Warning - Milled Outside Lever | \$72.00 |
| 77 | Tactile Warning - Milled Outside and Inside Lever | \$144.00 |
| F182▲† | SARGENT Keso Security Cylinder – patented – new key systems | \$84.00 / cyl. |
| F183▲† | SARGENT Keso Security Removable Core Cylinder – patented – new key systems | \$120.00 / cyl. |
| 81▲† | Cylinder to accept Keso (83) and Keso F1(F183) Removable Core – no core provided | No addition |
| 82▲† | SARGENT Keso Security Cylinder (For existing systems only) | \$84.00 / cyl. |
| 83▲† | SARGENT Keso Security Removable Core Cylinder (For existing systems only) | \$120.00 / cyl. |
| 84▲† | SARGENT Keso Security Removable Construction Core Cylinder | See CK-18 |
| 85 | Tactile Warning - Abrasive Coating on Inside Lever | \$45.00 |
| 86 | Tactile Warning - Abrasive Coating on Outside Lever | \$45.00 |
| 87 | Tactile Warning - Abrasive Coating on Outside & Inside Lever | \$90.00 |
| BR | SARGENT Bump Resistant Cylinders (N/A w/10, 22, 30, 60, 63, 64, 70, 72, 73, 737P, KESO, SC, & SE options) | \$23.00 /cyl. |
| DG1 | Patented Degree DG1 Key System | No Addition |
| DG160 | Hardware prepared for DG1-6300 Lg. Format IC cores, supplied with temporary plastic construction cores | No addition |
| DG163 | Patented Degree DG1 Large Format Interchangeable Core Cylinder - Includes master keying charges | \$77.00 |
| DG164 | Hardware prepared for DG1-6300 Lg. Format IC cores, supplied with temporary keyed construction cores | \$77.00 |
| DG2 | Patented Degree DG2 Key System incorporating a locking sidebar | \$58.00/cyl. |
| DG260 | Hardware prepared for DG2-6300 Lg. Format IC cores, supplied with temporary plastic construction cores | No addition |
| DG263 | Patented Degree DG2 Large Format Interchangeable Core Cylinder - Includes master keying charges | \$135.00 |
| DG264 | Hardware prepared for DG2-6300 Lg. Format IC cores, supplied with temporary keyed construction cores | \$77.00 |
| DG3 | Patented Degree DG3 Key System incorporating a locking sidebar and UL437 listed | \$82.00/cyl. |
| DG360 | Hardware prepared for DG3-6300 Lg. Format IC cores, supplied with temporary plastic construction cores | No addition |
| DG363 | Patented Degree DG3 Large Format Interchangeable Core Cylinder - Includes master keying charges | \$159.00 |
| DG364 | Hardware prepared for DG3-6300 Lg. Format IC cores, supplied with temporary keyed construction cores | \$77.00 |
| LB | Extra large thumbturn | \$16.00 |
| LC | Less Cylinder | -\$89.00/cyl. |
| OBS | Open Back Strike | \$73.00 |
| RX | Request to Exit | \$190.00 |
| SC▲† | Schlage "C" Keyway cylinder, (Number 41 Cylinder Only, 0 bitted) | No addition |
| SE▲† | Schlage "E" Keyway cylinder, (Number 41 Cylinder Only, 0 bitted) | No addition |
| SG | MicroShield® – an antimicrobial powder coat finish | \$67.00 |
| WBS | Wrought Box Strike | No addition |

NOTES: ▲ Options not available with a standard 50 function lockout cylinder. † Not available with 60, 63, 64 options.

CPC 7904 x OBL x RH x 32D x CPC (Clear Powder Coat) \$62.00
All orders will continue to be handled as a "special" when CPC is ordered.

USA & Canada Prices Effective June 3, 2019



OBL Lever



OBB Lever



OBP Lever



OBJ Lever

Rose: O (Shown) Levers: BL, BB, BP, BJ (Shown)

| Function | | Finish | |
|---|------------------------------------|------------------|--|
| | | 10BE/26D/BSP/WSP | 03/04/09/10/10B/10BL/14/15/20D/26/32/32D |
| Single Cyl | | | |
| 7904 | Storeroom or Closet | | |
| 7937 | Classroom | \$738.00 | \$762.00 |
| 7955 | Office or Entry | | |
| Single Cyl With Deadbolt | | | |
| 7924 | Room Door | | |
| 7925 | Dormitory or Exit | | |
| 7943 | Apartment Corridor | \$756.00 | \$780.00 |
| 7945 | Dormitory or Exit | | |
| 7950 | Hotel Guest Lock | \$816.00 | \$840.00 |
| Double Cyl No Deadbolt | | | |
| 7916 | Apartment or Exit or Public Toilet | \$813.00 | \$837.00 |
| 7938 | Classroom Security Intruder | | |
| Double Cyl With Deadbolt | | | |
| 7926 | Store Door | \$829.00 | \$853.00 |
| Electro Mechanical Single Cyl – Specify 12V or 24V | | | |
| 7970-12V / 7970-24V | Fail Safe | | |
| 7971-12V / 7971-24V | Fail Secure | \$1,023.00 | \$1,047.00 |
| Electro Mechanical Double Cyl – Specify 12V or 24V | | | |
| 7972-12V / 7972-24V | Fail Safe | | |
| 7973-12V / 7973-24V | Fail Secure | \$1,096.00 | \$1,120.00 |
| Non Keyed | | | |
| 7915 | Passage or Closet | \$572.00 | \$596.00 |
| 7965 | Privacy Bedroom or Bath (Latch) | \$665.00 | \$689.00 |
| 7966 | Privacy Bedroom or Bath (Deadbolt) | \$702.00 | \$726.00 |
| 7993 | Single Dummy Trim | \$236.00 | \$248.00 |
| 7994 | Double Dummy Trim | \$475.00 | \$499.00 |
| 7995 | Single Dummy Trim w/Lockbody | \$321.00 | \$333.00 |

ML-124 MORTISE LOCKS

SARGENT®

ASSA ABLOY

OPTIONS

USA & Canada Prices Effective June 3, 2019

| Options | Description | Price |
|----------|---|--|
| 1▲ | 7900 Line with 1-1/16" wide front for 1-3/8" doors. | \$58.00 |
| 10▲ | SARGENT Signature Key System | \$58.00 / cyl. |
| 11†▲ | SARGENT XC Key System (not available with 10, 22, SC, SE options) | No addition |
| 1160 | Sargent XC Removable Plastic Disposable Construction Core | No addition |
| 1163 | SARGENT XC Large Format Interchangeable Core Cylinder - Includes masterkeying charges | \$77.00 |
| 1164 | SARGENT XC Large Format Interchangeable Construction Core Cylinder | \$77.00 |
| 1170 | Small Format interchangeable disposable construction core - to accept 7 Pin XC permanent core | No addition |
| 11727P | Small Format interchangeable keyed construction core - to accept 7 Pin XC permanent core | \$69.00 |
| 11737P | Small Format interchangeable core - to accept 7 pin XC permanent core | \$69.00 / cyl. |
| 21▲† | SARGENT Construction Key System (lost ball) Standard on all new systems established since 5/1/96 | \$16.00 / cyl. |
| 22▲† | SARGENT Construction Key System (split key) To be used on pre-established split key systems only | \$32.00 / cyl. |
| 31 | Thick Doors - Extended Lip Required - Specify Length C to E | |
| | - Cylinders - IMPORTANT- See catalog 7800/8200 option page for cylinder limitations | |
| | - Below charges DO NOT include additional charges for special cylinder requirements | |
| | Doors up to 2-1/2" thick - lock centered | No addition |
| | Doors 2-5/8" to 6" thick OR doors 1-3/4" thick w/max 1" paneling one side. | |
| | For example: Specify 1-3/4" door with panel (Side) on inside or outside | Non Keyed function \$50.00 Keyed function \$100.00 |
| 36 | 6 Lobe security head screws | \$23.00 |
| 37 | Spanner head screws | \$16.00 |
| 60 | SARGENT Large Format Interchangeable Plastic Disposable Construction Core | No addition |
| 63 | SARGENT Large Format Interchangeable core cylinder, includes master keying charges | \$77.00 / cyl. |
| 64 | SARGENT Large Format Interchangeable Construction Core Cylinder | \$77.00 |
| 6573▲† | Small Format 6-Pin Uncombined Core (Refer to CK-12) | \$59.00 / cyl. |
| 65737P▲† | Small Format 7-Pin Uncombined Core (Refer to CK-12) | \$59.00 / cyl. |
| 68 | 7900 Line furnished with lever handle outside x knob inside | Defaults to 7900 Lever Lock Price |
| 69 | 7900 Line furnished with lever handle inside x knob outside | Defaults to 7900 Lever Lock Price |
| 70▲† | Small Format Interchangeable disposable plastic construction core | No addition |
| 72▲† | Small Format Interchangeable 6-pin construction core (7-pin with 11 options) | \$69.00 |
| 73▲† | Small Format interchangeable core 6-pin Includes MK and GMK keying charges | \$69.00 / cyl |
| 737P▲† | Small Format interchangeable core 7-pin (refer to CK-12 for available keyways) Includes MK and GMK keying charges | \$69.00 / cyl |
| 75 | Tactile Warning - Milled Inside Lever | \$72.00 |
| 76 | Tactile Warning - Milled Outside Lever | \$72.00 |
| 77 | Tactile Warning - Milled Outside and Inside Lever | \$144.00 |
| F182▲† | SARGENT Keso Security Cylinder – patented – new key systems | \$84.00 / cyl. |
| F183▲† | SARGENT Keso Security Removable Core Cylinder – patented – new key systems | \$120.00 / cyl. |
| 81▲† | Cylinder to accept Keso (83) and Keso F1(F183) Removable Core – no core provided | No addition |
| 82▲† | SARGENT Keso Security Cylinder (For existing systems only) | \$84.00 / cyl. |
| 83▲† | SARGENT Keso Security Removable Core Cylinder (For existing systems only) | \$120.00 / cyl. |
| 84▲† | SARGENT Keso Security Removable Construction Core Cylinder | See CK-18 |
| 85 | Tactile Warning - Abrasive Coating on Inside Lever | \$45.00 |
| 86 | Tactile Warning - Abrasive Coating on Outside Lever | \$45.00 |
| 87 | Tactile Warning - Abrasive Coating on Outside & Inside Lever | \$90.00 |
| BR | SARGENT Bump Resistant Cylinders (N/A w/10, 22, 30, 60, 63, 64, 70, 72, 73, 737P, KESO, SC, & SE options) | \$23.00 /cyl. |
| DG1 | Patented Degree DG1 Key System | No Addition |
| DG160 | Hardware prepared for DG1-6300 Lg. Format IC cores, supplied with temporary plastic construction cores | No addition |
| DG163 | Patented Degree DG1 Large Format Interchangeable Core Cylinder - Includes master keying charges | \$77.00 |
| DG164 | Hardware prepared for DG1-6300 Lg. Format IC cores, supplied with temporary keyed construction cores | \$77.00 |
| DG2 | Patented Degree DG2 Key System incorporating a locking sidebar | \$58.00/cyl. |
| DG260 | Hardware prepared for DG2-6300 Lg. Format IC cores, supplied with temporary plastic construction cores | No addition |
| DG263 | Patented Degree DG2 Large Format Interchangeable Core Cylinder - Includes master keying charges | \$135.00 |
| DG264 | Hardware prepared for DG2-6300 Lg. Format IC cores, supplied with temporary keyed construction cores | \$77.00 |
| DG3 | Patented Degree DG3 Key System incorporating a locking sidebar and UL437 listed | \$82.00/cyl. |
| DG360 | Hardware prepared for DG3-6300 Lg. Format IC cores, supplied with temporary plastic construction cores | No addition |
| DG363 | Patented Degree DG3 Large Format Interchangeable Core Cylinder - Includes master keying charges | \$159.00 |
| DG364 | Hardware prepared for DG3-6300 Lg. Format IC cores, supplied with temporary keyed construction cores | \$77.00 |
| LC | Less Cylinder | -\$89.00/cyl. |
| OBS | Open Back Strike | \$73.00 |
| RX | Request to Exit | \$190.00 |
| SC▲† | Schlage "C" Keyway cylinder, (Number 41 Cylinder Only, 0 bitted) | No addition |
| SE▲† | Schlage "E" Keyway cylinder, (Number 41 Cylinder Only, 0 bitted) | No addition |
| SG | MicroShield® – an antimicrobial powder coat finish | \$67.00 |
| WBS | Wrought Box Strike | No addition |

NOTES: ▲ Options not available with a standard 50 function lockout cylinder. † Not available with 60, 63, 64 options.

| | | |
|-----|---|---------|
| CPC | 7904 x LW1BL x RH x 32D x CPC (Clear Powder Coat) All orders will continue to be handled as a "special" when CPC is ordered. | \$62.00 |
|-----|---|---------|

USA & Canada Prices Effective June 3, 2019



LW1BL Lever



LW1BB Lever



LW1BP Lever



LW1BJ Lever

Escutcheon: LW1 (Shown) Levers: BL, BB, BP, BJ (Shown)

| Function | | Finish | |
|---|------------------------------------|------------------|--|
| | | 10BE/26D/BSP/WSP | 03/04/09/10/10B/10BL/14/15/20D/26/32/32D |
| Single Cyl | | | |
| 7904 | Storeroom or Closet | | |
| 7937 | Classroom | \$772.00 | \$796.00 |
| 7955 | Office or Entry | | |
| Single Cyl With Deadbolt | | | |
| 7924 | Room Door | | |
| 7925 | Dormitory or Exit | | |
| 7943 | Apartment Corridor | \$791.00 | \$815.00 |
| 7945 | Dormitory or Exit | | |
| 7950 | Hotel Guest Lock | \$860.00 | \$884.00 |
| Double Cyl No Deadbolt | | | |
| 7916 | Apartment or Exit or Public Toilet | \$854.00 | \$878.00 |
| 7938 | Classroom Security Intruder | | |
| Double Cyl With Deadbolt | | | |
| 7926 | Store Door | \$869.00 | \$893.00 |
| Electro Mechanical Single Cyl – Specify 12V or 24V | | | |
| 7970-12V / 7970-24V | Fail Safe | \$1,058.00 | \$1,082.00 |
| 7971-12V / 7971-24V | Fail Secure | | |
| Electro Mechanical Double Cyl – Specify 12V or 24V | | | |
| 7972-12V / 7972-24V | Fail Safe | \$1,135.00 | \$1,159.00 |
| 7973-12V / 7973-24V | Fail Secure | | |
| Non Keyed | | | |
| 7915 | Passage or Closet | \$602.00 | \$626.00 |
| 7965 | Privacy Bedroom or Bath (Latch) | \$699.00 | \$723.00 |
| 7966 | Privacy Bedroom or Bath (Deadbolt) | \$733.00 | \$757.00 |
| 7993 | Single Dummy Trim | \$248.00 | \$260.00 |
| 7994 | Double Dummy Trim | \$497.00 | \$521.00 |
| 7995 | Single Dummy Trim w/Lockbody | \$332.00 | \$344.00 |

ML-126 MORTISE LOCKS

SARGENT®

ASSA ABLOY

OPTIONS

USA & Canada Prices Effective June 3, 2019

| Options | Description | Price |
|----------|---|--|
| 1▲ | 7900 Line with 1-1/16" wide front for 1-3/8" doors. | \$58.00 |
| 10▲ | SARGENT Signature Key System | \$58.00 / cyl. |
| 11†▲ | SARGENT XC Key System (not available with 10, 22, SC, SE options) | No addition |
| 1160 | SARGENT XC Large Format Interchangeable Plastic Disposable Construction Core | No addition |
| 1163 | SARGENT XC Large Format Interchangeable Core Cylinder - Includes masterkeying charges | \$77.00 |
| 1164 | SARGENT XC Large Format Interchangeable Construction Core Cylinder | \$77.00 |
| 1170 | Small Format interchangeable disposable construction core - to accept 7 Pin XC permanent core | No addition |
| 11727P | Small Format interchangeable keyed construction core - to accept 7 Pin XC permanent core | \$69.00 |
| 11737P | Small Format interchangeable core - to accept 7 pin XC permanent core | \$69.00 / cyl. |
| 21▲† | SARGENT Construction Key System (lost ball) Standard on all new systems established since 5/1/96 | \$16.00 / cyl. |
| 22▲† | SARGENT Construction Key System (split key) To be used on pre-established split key systems only | \$32.00 / cyl. |
| 31 | Thick Doors - Extended Lip Required - Specify Length C to E - Cylinders - IMPORTANT- See catalog 7800/8200 option page for cylinder limitations - Below charges DO NOT include additional charges for special cylinder requirements | |
| | Doors up to 2-1/2" thick - lock centered | No addition |
| | Doors 2-5/8" to 6" thick OR doors 1-3/4" thick w/max 1" paneling one side. For example: Specify 1-3/4" door with panel (Side) on inside or outside | Non Keyed function \$50.00 Keyed function \$100.00 |
| 36 | 6 Lobe security head screws | \$23.00 |
| 37 | Spanner head screws | \$16.00 |
| 60 | SARGENT Large Format Interchangeable Plastic Disposable Construction Core | No addition |
| 63 | SARGENT Large Format Interchangeable core cylinder, includes master keying charges | \$77.00 / cyl. |
| 64 | SARGENT Large Format Interchangeable Construction Core Cylinder | \$77.00 |
| 6573▲† | Small Format 6-Pin Uncombined Core (Refer to CK-12) | \$59.00 / cyl. |
| 65737P▲† | Small Format 7-Pin Uncombined Core (Refer to CK-12) | \$59.00 / cyl. |
| 68 | 7900 Line furnished with lever handle outside x knob inside | Defaults to 7900 Lever Lock Price |
| 69 | 7900 Line furnished with lever handle inside x knob outside | Defaults to 7900 Lever Lock Price |
| 70▲† | Small Format Interchangeable disposable plastic construction core | No addition |
| 72▲† | Small Format Interchangeable 6-pin construction core (7-pin with 11 options) | \$69.00 |
| 73▲† | Small Format interchangeable core 6-pin Includes MK and GMK keying charges | \$69.00 / cyl |
| 737P▲† | Small Format interchangeable core 7-pin (refer to CK-12 for available keyways) Includes MK and GMK keying charges | \$69.00 / cyl |
| 75 | Tactile Warning - Milled Inside Lever | \$72.00 |
| 76 | Tactile Warning - Milled Outside Lever | \$72.00 |
| 77 | Tactile Warning - Milled Outside and Inside Lever | \$144.00 |
| F182▲† | SARGENT Keso Security Cylinder – patented – new key systems | \$84.00 / cyl. |
| F183▲† | SARGENT Keso Security Removable Core Cylinder – patented – new key systems | \$120.00 / cyl. |
| 81▲† | Cylinder to accept Keso (83) and Keso F1(F183) Removable Core – no core provided | No addition |
| 82▲† | SARGENT Keso Security Cylinder (For existing systems only) | \$84.00 / cyl. |
| 83▲† | SARGENT Keso Security Removable Core Cylinder (For existing systems only) | \$120.00 / cyl. |
| 84▲† | SARGENT Keso Security Removable Construction Core Cylinder | See CK-18 |
| 85 | Tactile Warning - Abrasive Coating on Inside Lever | \$45.00 |
| 86 | Tactile Warning - Abrasive Coating on Outside Lever | \$45.00 |
| 87 | Tactile Warning - Abrasive Coating on Outside & Inside Lever | \$90.00 |
| BR | SARGENT Bump Resistant Cylinders (N/A w/10, 22, 30, 60, 63, 64, 70, 72, 73, 737P, KESO, SC, & SE options) | \$23.00 /cyl. |
| DG1 | Patented Degree DG1 Key System | No Addition |
| DG160 | Hardware prepared for DG1-6300 Lg. Format IC cores, supplied with temporary plastic construction cores | No addition |
| DG163 | Patented Degree DG1 Large Format Interchangeable Core Cylinder - Includes master keying charges | \$77.00 |
| DG164 | Hardware prepared for DG1-6300 Lg. Format IC cores, supplied with temporary keyed construction cores | \$77.00 |
| DG2 | Patented Degree DG2 Key System incorporating a locking sidebar | \$58.00/cyl. |
| DG260 | Hardware prepared for DG2-6300 Lg. Format IC cores, supplied with temporary plastic construction cores | No addition |
| DG263 | Patented Degree DG2 Large Format Interchangeable Core Cylinder - Includes master keying charges | \$135.00 |
| DG264 | Hardware prepared for DG2-6300 Lg. Format IC cores, supplied with temporary keyed construction cores | \$77.00 |
| DG3 | Patented Degree DG3 Key System incorporating a locking sidebar and UL437 listed | \$82.00/cyl. |
| DG360 | Hardware prepared for DG3-6300 Lg. Format IC cores, supplied with temporary plastic construction cores | No addition |
| DG363 | Patented Degree DG3 Large Format Interchangeable Core Cylinder - Includes master keying charges | \$159.00 |
| DG364 | Hardware prepared for DG3-6300 Lg. Format IC cores, supplied with temporary keyed construction cores | \$77.00 |
| LC | Less Cylinder | -\$89.00/cyl. |
| OBS | Open Back Strike | \$73.00 |
| RX | Request to Exit | \$190.00 |
| SC▲† | Schlage "C" Keyway cylinder, (Number 41 Cylinder Only, 0 bitted) | No addition |
| SE▲† | Schlage "E" Keyway cylinder, (Number 41 Cylinder Only, 0 bitted) | No addition |
| SG | MicroShield® – an antimicrobial powder coat finish | \$67.00 |
| WBS | Wrought Box Strike | No addition |

NOTES: ▲ Options not available with a standard 50 function lockout cylinder. † Not available with 60, 63, 64 options.

| | | |
|-----|--|---------|
| CPC | 7904 x WTBL x RH x 32D x CPC (Clear Powder Coat) All orders will continue to be handled as a "special" when CPC is ordered. | \$62.00 |
|-----|--|---------|

USA & Canada Prices Effective June 3, 2019



WTBL Lever



WTBB Lever



WTBP Lever



WTBJ Lever

Escutcheon: WT (Shown) Levers: BL, BB, BP, BJ (Shown)

| Function | | Finish | |
|---|------------------------------------|------------------|--|
| | | 10BE/26D/BSP/WSP | 03/04/09/10/10B/10BL/14/15/20D/26/32/32D |
| Single Cyl | | | |
| 7904 | Storeroom or Closet | | |
| 7937 | Classroom | \$761.00 | \$785.00 |
| 7955 | Office or Entry | | |
| Single Cyl With Deadbolt | | | |
| 7924 | Room Door | | |
| 7925 | Dormitory or Exit | | |
| 7943 | Apartment Corridor | \$772.00 | \$796.00 |
| 7945 | Dormitory or Exit | | |
| 7950 | Hotel Guest Lock | \$847.00 | \$871.00 |
| Double Cyl No Deadbolt | | | |
| 7916 | Apartment or Exit or Public Toilet | \$837.00 | \$861.00 |
| 7938 | Classroom Security Intruder | | |
| Double Cyl With Deadbolt | | | |
| 7926 | Store Door | \$853.00 | \$877.00 |
| Electro Mechanical Single Cyl – Specify 12V or 24V | | | |
| 7970-12V / 7970-24V | Fail Safe | \$1,044.00 | \$1,068.00 |
| 7971-12V / 7971-24V | Fail Secure | | |
| Electro Mechanical Double Cyl – Specify 12V or 24V | | | |
| 7972-12V / 7972-24V | Fail Safe | \$1,121.00 | \$1,145.00 |
| 7973-12V / 7973-24V | Fail Secure | | |
| Non Keyed | | | |
| 7915 | Passage or Closet | \$590.00 | \$614.00 |
| 7965 | Privacy Bedroom or Bath (Latch) | \$683.00 | \$707.00 |
| 7966 | Privacy Bedroom or Bath (Deadbolt) | \$718.00 | \$742.00 |
| 7993 | Single Dummy Trim | \$241.00 | \$253.00 |
| 7994 | Double Dummy Trim | \$482.00 | \$506.00 |
| 7995 | Single Dummy Trim w/Lockbody | \$327.00 | \$339.00 |

ML-128 MORTISE LOCKS

SARGENT®

OPTIONS

ASSA ABLOY

USA & Canada Prices Effective June 3, 2019

| Options | Description | Price |
|----------|---|--|
| 1▲ | 7900 Line with 1-1/16" wide front for 1-3/8" doors. | \$58.00 |
| 10▲ | SARGENT Signature Key System | \$58.00 / cyl. |
| 11†▲ | SARGENT XC Key System (not available with 10, 22, SC, SE options) | No addition |
| 1160 | SARGENT XC Large Format Interchangeable Plastic Disposable Construction Core | No addition |
| 1163 | SARGENT XC Large Format Interchangeable Core Cylinder - Includes masterkeying charges | \$77.00 |
| 1164 | SARGENT XC Large Format Interchangeable Construction Core Cylinder | \$77.00 |
| 1170 | Small Format interchangeable disposable construction core - to accept 7 Pin XC permanent core | No addition |
| 11727P | Small Format interchangeable keyed construction core - to accept 7 Pin XC permanent core | \$69.00 |
| 11737P | Small Format interchangeable core - to accept 7 pin XC permanent core | \$69.00 / cyl. |
| 21▲† | SARGENT Construction Key System (lost ball) Standard on all new systems established since 5/1/96 | \$16.00 / cyl. |
| 22▲† | SARGENT Construction Key System (split key) To be used on pre-established split key systems only | \$32.00 / cyl. |
| 31 | Thick Doors - Extended Lip Required - Specify Length C to E | |
| | - Cylinders - IMPORTANT- See catalog 7800/8200 option page for cylinder limitations | |
| | - Below charges DO NOT include additional charges for special cylinder requirements | |
| | Doors up to 2-1/2" thick - lock centered | No addition |
| | Doors 2-5/8" to 6" thick OR doors 1-3/4" thick w/max 1" paneling one side. | |
| | For example: Specify 1-3/4" door with panel (Side) on inside or outside | Non Keyed function \$50.00 Keyed function \$100.00 |
| 60 | SARGENT Large Format Interchangeable Plastic Disposable Construction Core | No addition |
| 63 | SARGENT Large Format Interchangeable core cylinder, includes master keying charges | \$77.00 / cyl. |
| 64 | SARGENT Large Format Interchangeable Construction Core Cylinder | \$77.00 |
| 6573▲† | Small Format 6-Pin Uncombined Core (Refer to CK-12) | \$59.00 / cyl. |
| 65737P▲† | Small Format 7-Pin Uncombined Core (Refer to CK-12) | \$59.00 / cyl. |
| 70▲† | Small Format Interchangeable disposable plastic construction core | No addition |
| 72▲† | Small Format Interchangeable 6-pin construction core (7-pin with 11 options) | \$69.00 |
| 73▲† | Small Format interchangeable core 6-pin Includes MK and GMK keying charges | \$69.00 / cyl. |
| 737P▲† | Small Format interchangeable core 7-pin (refer to CK-12 for available keyways) Includes MK and GMK keying charges | \$69.00 / cyl. |
| 74 | Lock case wrapped in lead - handing required (roses not available) | \$272.00 |
| F182▲† | SARGENT Keso Security Cylinder – patented – new key systems | \$84.00 / cyl. |
| F183▲† | SARGENT Keso Security Removable Core Cylinder – patented – new key systems | \$120.00 / cyl. |
| 81▲† | Cylinder to accept Keso (83) and Keso F1(F183) Removable Core – no core provided | No addition |
| 82▲† | SARGENT Keso Security Cylinder (For existing systems only) | \$84.00 / cyl. |
| 83▲† | SARGENT Keso Security Removable Core Cylinder (For existing systems only) | \$120.00 / cyl. |
| 84▲† | SARGENT Keso Security Removable Construction Core Cylinder | See CK-18 |
| 85 | Tactile Warning - Abrasive coating on inside lever | \$45.00 |
| 86 | Tactile Warning - Abrasive coating on outside lever | \$45.00 |
| 87 | Tactile Warning - Abrasive coating on both levers | \$90.00 |
| BR | SARGENT Bump Resistant Cylinders (N/A w/10, 22, 30, 60, 63, 64, 70, 72, 73, 737P, KESO, SC, & SE options) | \$23.00 / cyl. |
| DG1 | Patented Degree DG1 Key System | No Addition |
| DG160 | Hardware prepared for DG1-6300 Lg. Format IC cores, supplied with temporary plastic construction cores | No addition |
| DG163 | Patented Degree DG1 Large Format Interchangeable Core Cylinder - Includes master keying charges | \$77.00 |
| DG164 | Hardware prepared for DG1-6300 Lg. Format IC cores, supplied with temporary keyed construction cores | \$77.00 |
| DG2 | Patented Degree DG2 Key System incorporating a locking sidebar | \$58.00/cyl. |
| DG260 | Hardware prepared for DG2-6300 Lg. Format IC cores, supplied with temporary plastic construction cores | No addition |
| DG263 | Patented Degree DG2 Large Format Interchangeable Core Cylinder - Includes master keying charges | \$135.00 |
| DG264 | Hardware prepared for DG2-6300 Lg. Format IC cores, supplied with temporary keyed construction cores | \$77.00 |
| DG3 | Patented Degree DG3 Key System incorporating a locking sidebar and UL437 listed | \$82.00/cyl. |
| DG360 | Hardware prepared for DG3-6300 Lg. Format IC cores, supplied with temporary plastic construction cores | No addition |
| DG363 | Patented Degree DG3 Large Format Interchangeable Core Cylinder - Includes master keying charges | \$159.00 |
| DG364 | Hardware prepared for DG3-6300 Lg. Format IC cores, supplied with temporary keyed construction cores | \$77.00 |
| LB | Extra large thumbturn | \$16.00 |
| LC | Less Cylinder | -\$89.00/cyl. |
| OBS | Open Back Strike | \$73.00 |
| RX | Request to Exit | \$190.00 |
| SC▲† | Schlage "C" Keyway cylinder, (Number 41 Cylinder Only, 0 bitted) | No addition |
| SE▲† | Schlage "E" Keyway cylinder, (Number 41 Cylinder Only, 0 bitted) | No addition |
| SG | MicroShield® – an antimicrobial powder coat finish | \$67.00 |
| T1 | Decorative thumbturn; backplate matches rose design chosen | No Addition |
| T2 | Decorative square thumbturn; backplate matches rose design chosen | No Addition |
| T3 | Decorative cylinder thumbturn; backplate matches rose design chosen | No Addition |
| WBS | Wrought Box Strike | No addition |

NOTES: ▲ Options not available with a standard 50 function lockout cylinder. † Not available with 60, 63, 64 options.

| | | |
|-----|---|---------|
| CPC | 7904 x OH001 x RH x 32D x CPC (Clear Powder Coat) All orders will continue to be handled as a "special" when CPC is ordered. | \$62.00 |
|-----|---|---------|

Rose Design:

CO (2-3/4")
CR (2-3/16")
LN (2")
O (2-3/4")
TO (2-3/4")
TR (2-3/16")
E2 (2-11/16")
E3 (2-1/16")
E4 (3-1/4")

Lever Designs:

H001, H002



H001



H002

How to order:

60-7904 x COH001 x RH x 26D
Option 60
Function 7904
Rose CO
Lever H001
Hand RH
Finish 26D

| Function | | Finish | |
|---|------------------------------------|------------------|-------------------------------------|
| Single Cyl | | 10BE/26D/BSP/WSP | 03/04/09/10/10B/14/15/20D/26/32/32D |
| 7904 | Storeroom or Closet | | |
| 7937 | Classroom | \$774.00 | \$798.00 |
| 7955 | Office or Entry | | |
| Single Cyl With Deadbolt | | | |
| 7924 | Room Door | | |
| 7925 | Dormitory or Exit | | |
| 7943 | Apartment Corridor | \$796.00 | \$820.00 |
| 7945 | Dormitory or Exit | | |
| 7950 | Hotel Guest Lock | \$856.00 | \$880.00 |
| Double Cyl No Deadbolt | | | |
| 7916 | Apartment or Exit or Public Toilet | \$853.00 | \$877.00 |
| 7938 | Classroom Security Intruder | | |
| Double Cyl With Deadbolt | | | |
| 7926 | Store Door | \$869.00 | \$893.00 |
| Electro Mechanical Single Cyl – Specify 12V or 24V | | | |
| 7970-12V / 7970-24V | Fail Safe | \$1,061.00 | \$1,085.00 |
| 7971-12V / 7971-24V | Fail Secure | | |
| Electro Mechanical Double Cyl – Specify 12V or 24V | | | |
| 7972-12V / 7972-24V | Fail Safe | \$1,139.00 | \$1,163.00 |
| 7973-12V / 7973-24V | Fail Secure | | |
| Non Keyed | | | |
| 7915 | Passage or Closet | \$614.00 | \$638.00 |
| 7965 | Privacy Bedroom or Bath (Latch) | \$704.00 | \$728.00 |
| 7966 | Privacy Bedroom or Bath (Deadbolt) | \$739.00 | \$763.00 |
| 7993 | Single Dummy Trim | \$243.00 | \$267.00 |
| 7994 | Double Dummy Trim | \$507.00 | \$531.00 |
| 7995 | Single Dummy Trim w/Lockbody | \$326.00 | \$350.00 |

ML-130 MORTISE LOCKS

SARGENT®

ASSA ABLOY

OPTIONS

USA & Canada Prices Effective June 3, 2019

| Options | Description | Price |
|----------|---|--|
| 1▲ | 7900 Line with 1-1/16" wide front for 1-3/8" doors. | \$58.00 |
| 10▲ | SARGENT Signature Key System | \$58.00 / cyl. |
| 11†▲ | SARGENT XC Key System (not available with 10, 22, SC, SE options) | No addition |
| 1160 | SARGENT XC Large Format Interchangeable Plastic Disposable Construction Core | No addition |
| 1163 | SARGENT XC Large Format Interchangeable Core Cylinder - Includes masterkeying charges | \$77.00 |
| 1164 | SARGENT XC Large Format Interchangeable Construction Core Cylinder | \$77.00 |
| 1170 | Small Format interchangeable disposable construction core - to accept 7 Pin XC permanent core | No addition |
| 11727P | Small Format interchangeable keyed construction core - to accept 7 Pin XC permanent core | \$69.00 |
| 11737P | Small Format interchangeable core - to accept 7 pin XC permanent core | \$69.00 / cyl. |
| 21▲† | SARGENT Construction Key System (lost ball) Standard on all new systems established since 5/1/96 | \$16.00 / cyl. |
| 22▲† | SARGENT Construction Key System (split key) To be used on pre-established split key systems only | \$32.00 / cyl. |
| 31 | Thick Doors - Extended Lip Required - Specify Length C to E | |
| | - Cylinders - IMPORTANT- See catalog 7800/8200 option page for cylinder limitations | |
| | - Below charges DO NOT include additional charges for special cylinder requirements | |
| | Doors up to 2-1/2" thick - lock centered | No addition |
| | Doors 2-5/8" to 6" thick OR doors 1-3/4" thick w/max 1" paneling one side. | |
| | For example: Specify 1-3/4" door with panel (Side) on inside or outside | Non Keyed function \$50.00 Keyed function \$100.00 |
| 60 | SARGENT Large Format Interchangeable Plastic Disposable Construction Core | No addition |
| 63 | SARGENT Large Format Interchangeable core cylinder, includes master keying charges | \$77.00 / cyl. |
| 64 | SARGENT Large Format Interchangeable Construction Core Cylinder | \$77.00 |
| 6573▲† | Small Format 6-Pin Uncombined Core (Refer to CK-12) | \$59.00 / cyl. |
| 65737P▲† | Small Format 7-Pin Uncombined Core (Refer to CK-12) | \$59.00 / cyl. |
| 70▲† | Small Format Interchangeable disposable plastic construction core | No addition |
| 72▲† | Small Format Interchangeable 6-pin construction core (7-pin with 11 options) | \$69.00 |
| 73▲† | Small Format interchangeable core 6-pin Includes MK and GMK keying charges | \$69.00 / cyl |
| 737P▲† | Small Format interchangeable core 7-pin (refer to CK-12 for available keyways) Includes MK and GMK keying charges | \$69.00 / cyl |
| 74 | Lock case wrapped in lead - handing required (roses not available) | \$272.00 |
| F182▲† | SARGENT Keso Security Cylinder – patented – new key systems | \$84.00 / cyl. |
| F183▲† | SARGENT Keso Security Removable Core Cylinder – patented – new key systems | \$120.00 / cyl. |
| 81▲† | Cylinder to accept Keso (83) and Keso F1(F183) Removable Core – no core provided | No addition |
| 82▲† | SARGENT Keso Security Cylinder (For existing systems only) | \$84.00 / cyl. |
| 83▲† | SARGENT Keso Security Removable Core Cylinder (For existing systems only) | \$120.00 / cyl. |
| 84▲† | SARGENT Keso Security Removable Construction Core Cylinder | See CK-18 |
| 85 | Tactile Warning - Abrasive coating on inside lever | \$45.00 |
| 86 | Tactile Warning - Abrasive coating on outside lever | \$45.00 |
| 87 | Tactile Warning - Abrasive coating on both levers | \$90.00 |
| BR | SARGENT Bump Resistant Cylinders (N/A w/10, 22, 30, 60, 63, 64, 70, 72, 73, 737P, KESO, SC, & SE options) | \$23.00 /cyl. |
| DG1 | Patented Degree DG1 Key System | No Addition |
| DG160 | Hardware prepared for DG1-6300 Lg. Format IC cores, supplied with temporary plastic construction cores | No addition |
| DG163 | Patented Degree DG1 Large Format Interchangeable Core Cylinder - Includes master keying charges | \$77.00 |
| DG164 | Hardware prepared for DG1-6300 Lg. Format IC cores, supplied with temporary keyed construction cores | \$77.00 |
| DG2 | Patented Degree DG2 Key System incorporating a locking sidebar | \$58.00/cyl. |
| DG260 | Hardware prepared for DG2-6300 Lg. Format IC cores, supplied with temporary plastic construction cores | No addition |
| DG263 | Patented Degree DG2 Large Format Interchangeable Core Cylinder - Includes master keying charges | \$135.00 |
| DG264 | Hardware prepared for DG2-6300 Lg. Format IC cores, supplied with temporary keyed construction cores | \$77.00 |
| DG3 | Patented Degree DG3 Key System incorporating a locking sidebar and UL437 listed | \$82.00/cyl. |
| DG360 | Hardware prepared for DG3-6300 Lg. Format IC cores, supplied with temporary plastic construction cores | No addition |
| DG363 | Patented Degree DG3 Large Format Interchangeable Core Cylinder - Includes master keying charges | \$159.00 |
| DG364 | Hardware prepared for DG3-6300 Lg. Format IC cores, supplied with temporary keyed construction cores | \$77.00 |
| LB | Extra large thumbturn | \$16.00 |
| LC | Less Cylinder | -\$89.00/cyl. |
| OBS | Open Back Strike | \$73.00 |
| RX | Request to Exit | \$190.00 |
| SC▲† | Schlage "C" Keyway cylinder, (Number 41 Cylinder Only, 0 bitted) | No addition |
| SE▲† | Schlage "E" Keyway cylinder, (Number 41 Cylinder Only, 0 bitted) | No addition |
| SG | MicroShield® – an antimicrobial powder coat finish | \$67.00 |
| T1 | Decorative thumbturn; backplate matches rose design chosen | No Addition |
| T2 | Decorative square thumbturn; backplate matches rose design chosen | No Addition |
| T3 | Decorative cylinder thumbturn; backplate matches rose design chosen | No Addition |
| WBS | Wrought Box Strike | No addition |

NOTES: ▲ Options not available with a standard 50 function lockout cylinder. † Not available with 60, 63, 64 options.

| | | |
|-----|---|---------|
| CPC | 7904 x OH004 x RH x 32D x CPC (Clear Powder Coat) All orders will continue to be handled as a "special" when CPC is ordered. | \$62.00 |
|-----|---|---------|

Rose Design:

CO (2-3/4")
CR (2-3/16")
LN (2")
O (2-3/4")
TO (2-3/4")
TR (2-3/16")
E2 (2-11/16")
E3 (2-1/16")
E4 (3-1/4")

Lever Designs:

H003, H004, H005, H006, H007, H008, H009,
H010, H011



H004



H005

How to order:

60-7904 x COH003 x RH x 10BE
Option 60
Function 7904
Rose CO
Lever H004
Hand RH
Finish 10BE

| Function | | Finish | |
|---|------------------------------------|------------------|--|
| | | 10BE/26D/BSP/WSP | 03/04/09/10/10B/10BL/14/15/20D/26/32/32D |
| Single Cyl | | | |
| 7904 | Storeroom or Closet | | |
| 7937 | Classroom | \$833.00 | \$857.00 |
| 7955 | Office or Entry | | |
| Single Cyl With Deadbolt | | | |
| 7924 | Room Door | | |
| 7925 | Dormitory or Exit | | |
| 7943 | Apartment Corridor | \$853.00 | \$877.00 |
| 7945 | Dormitory or Exit | | |
| 7950 | Hotel Guest Lock | \$913.00 | \$937.00 |
| Double Cyl No Deadbolt | | | |
| 7916 | Apartment or Exit or Public Toilet | \$909.00 | \$933.00 |
| 7938 | Classroom Security Intruder | | |
| Double Cyl With Deadbolt | | | |
| 7926 | Store Door | \$920.00 | \$944.00 |
| Electro Mechanical Single Cyl – Specify 12V or 24V | | | |
| 7970-12V / 7970-24V | Fail Safe | \$1,103.00 | \$1,127.00 |
| 7971-12V / 7971-24V | Fail Secure | | |
| Electro Mechanical Double Cyl – Specify 12V or 24V | | | |
| 7972-12V / 7972-24V | Fail Safe | \$1,173.00 | \$1,197.00 |
| 7973-12V / 7973-24V | Fail Secure | | |
| Non Keyed | | | |
| 7915 | Passage or Closet | \$682.00 | \$706.00 |
| 7965 | Privacy Bedroom or Bath (Latch) | \$770.00 | \$794.00 |
| 7966 | Privacy Bedroom or Bath (Deadbolt) | \$801.00 | \$825.00 |
| 7993 | Single Dummy Trim | \$343.00 | \$367.00 |
| 7994 | Double Dummy Trim | \$586.00 | \$610.00 |
| 7995 | Single Dummy Trim w/Lockbody | \$421.00 | \$445.00 |

ML-132 MORTISE LOCKS

SARGENT®

ASSA ABLOY

OPTIONS

USA & Canada Prices Effective June 3, 2019

| Options | Description | Price |
|----------|---|--|
| 1▲ | 7900 Line with 1-1/16" wide front for 1-3/8" doors. | \$58.00 |
| 10▲ | SARGENT Signature Key System | \$58.00 / cyl. |
| 11†▲ | SARGENT XC Key System (not available with 10, 22, SC, SE options) | No addition |
| 1160 | SARGENT XC Large Format Interchangeable Plastic Disposable Construction Core | No addition |
| 1163 | SARGENT XC Large Format Interchangeable Core Cylinder - Includes masterkeying charges | \$77.00 |
| 1164 | SARGENT XC Large Format Interchangeable Construction Core Cylinder | \$77.00 |
| 1170 | Small Format interchangeable disposable construction core - to accept 7 Pin XC permanent core | No addition |
| 11727P | Small Format interchangeable keyed construction core - to accept 7 Pin XC permanent core | \$69.00 |
| 11737P | Small Format interchangeable core - to accept 7 pin XC permanent core | \$69.00 / cyl. |
| 21▲† | SARGENT Construction Key System (lost ball) Standard on all new systems established since 5/1/96 | \$16.00 / cyl. |
| 22▲† | SARGENT Construction Key System (split key) To be used on pre-established split key systems only | \$32.00 / cyl. |
| 31 | Thick Doors - Extended Lip Required - Specify Length C to E - Cylinders - IMPORTANT- See catalog 7800/8200 option page for cylinder limitations - Below charges DO NOT include additional charges for special cylinder requirements | |
| | Doors up to 2-1/2" thick - lock centered | No addition |
| | Doors 2-5/8" to 6" thick OR doors 1-3/4" thick w/max 1" paneling one side. For example: Specify 1-3/4" door with panel (Side) on inside or outside | Non Keyed function \$50.00 Keyed function \$100.00 |
| 60 | SARGENT Large Format Interchangeable Plastic Disposable Construction Core | No addition |
| 63 | SARGENT Large Format Interchangeable core cylinder, includes master keying charges | \$77.00 / cyl. |
| 64 | SARGENT Large Format Interchangeable Construction Core Cylinder | \$77.00 |
| 6573▲† | Small Format 6-Pin Uncombined Core (Refer to CK-12) | \$59.00 / cyl. |
| 65737P▲† | Small Format 7-Pin Uncombined Core (Refer to CK-12) | \$59.00 / cyl. |
| 70▲† | Small Format Interchangeable disposable plastic construction core | No addition |
| 72▲† | Small Format Interchangeable 6-pin construction core (7-pin with 11 options) | \$69.00 |
| 73▲† | Small Format interchangeable core 6-pin Includes MK and GMK keying charges | \$69.00 / cyl. |
| 737P▲† | Small Format interchangeable core 7-pin (refer to CK-12 for available keyways) Includes MK and GMK keying charges | \$69.00 / cyl. |
| 74 | Lock case wrapped in lead - handing required (roses not available) | \$272.00 |
| F182▲† | SARGENT Keso Security Cylinder – patented – new key systems | \$84.00 / cyl. |
| F183▲† | SARGENT Keso Security Removable Core Cylinder – patented – new key systems | \$120.00 / cyl. |
| 81▲† | Cylinder to accept Keso (83) and Keso F1(F183) Removable Core – no core provided | No addition |
| 82▲† | SARGENT Keso Security Cylinder (For existing systems only) | \$84.00 / cyl. |
| 83▲† | SARGENT Keso Security Removable Core Cylinder (For existing systems only) | \$120.00 / cyl. |
| 84▲† | SARGENT Keso Security Removable Construction Core Cylinder | See CK-18 |
| 85 | Tactile Warning - Abrasive coating on inside lever | \$45.00 |
| 86 | Tactile Warning - Abrasive coating on outside lever | \$45.00 |
| 87 | Tactile Warning - Abrasive coating on both levers | \$90.00 |
| BR | SARGENT Bump Resistant Cylinders (N/A w/10, 22, 30, 60, 63, 64, 70, 72, 73, 737P, KESO, SC, & SE options) | \$23.00 / cyl. |
| DG1 | Patented Degree DG1 Key System | No Addition |
| DG160 | Hardware prepared for DG1-6300 Lg. Format IC cores, supplied with temporary plastic construction cores | No addition |
| DG163 | Patented Degree DG1 Large Format Interchangeable Core Cylinder - Includes master keying charges | \$77.00 |
| DG164 | Hardware prepared for DG1-6300 Lg. Format IC cores, supplied with temporary keyed construction cores | \$77.00 |
| DG2 | Patented Degree DG2 Key System incorporating a locking sidebar | \$58.00/cyl. |
| DG260 | Hardware prepared for DG2-6300 Lg. Format IC cores, supplied with temporary plastic construction cores | No addition |
| DG263 | Patented Degree DG2 Large Format Interchangeable Core Cylinder - Includes master keying charges | \$135.00 |
| DG264 | Hardware prepared for DG2-6300 Lg. Format IC cores, supplied with temporary keyed construction cores | \$77.00 |
| DG3 | Patented Degree DG3 Key System incorporating a locking sidebar and UL437 listed | \$82.00/cyl. |
| DG360 | Hardware prepared for DG3-6300 Lg. Format IC cores, supplied with temporary plastic construction cores | No addition |
| DG363 | Patented Degree DG3 Large Format Interchangeable Core Cylinder - Includes master keying charges | \$159.00 |
| DG364 | Hardware prepared for DG3-6300 Lg. Format IC cores, supplied with temporary keyed construction cores | \$77.00 |
| LB | Extra large thumbturn | \$16.00 |
| LC | Less Cylinder | -\$89.00/cyl. |
| OBS | Open Back Strike | \$73.00 |
| RX | Request to Exit | \$190.00 |
| SC▲† | Schlage "C" Keyway cylinder, (Number 41 Cylinder Only, 0 bitted) | No addition |
| SE▲† | Schlage "E" Keyway cylinder, (Number 41 Cylinder Only, 0 bitted) | No addition |
| SG | MicroShield® – an antimicrobial powder coat finish | \$67.00 |
| T1 | Decorative thumbturn; backplate matches rose design chosen | No Addition |
| T2 | Decorative square thumbturn; backplate matches rose design chosen | No Addition |
| T3 | Decorative cylinder thumbturn; backplate matches rose design chosen | No Addition |
| WBS | Wrought Box Strike | No addition |

NOTES: ▲ Options not available with a standard 50 function lockout cylinder. † Not available with 60, 63, 64 options.

| | | |
|-----|---|---------|
| CPC | 7904 x OMC x RH x 32D x CPC (Clear Powder Coat) All orders will continue to be handled as a "special" when CPC is ordered. | \$62.00 |
|-----|---|---------|

Rose Design:

CO (2-3/4")
CR (2-3/16")
LN (2")
O (2-3/4")
TO (2-3/4")
TR (2-3/16")
E2 (2-11/16")
E3 (2-1/16")
E4 (3-1/4")

All Studio Collection Levers

~~(except Gramercy, Wooster Square, & Grant Park)~~

How to order: 60-7904 x CRMM x RH x 26D

Option 60
Function 7904
Rose CR
Lever MM
Hand RH
Finish 26D

| Function | | Finish | |
|---|------------------------------------|------------------|--|
| | | 10BE/26D/BSP/WSP | 03/04/09/10/10B/10BL/14/15/20D/26/32/32D |
| Single Cyl | | | |
| 7904 | Storeroom or Closet | | |
| 7937 | Classroom | \$738.00 | \$762.00 |
| 7955 | Office or Entry | | |
| Single Cyl With Deadbolt | | | |
| 7924 | Room Door | | |
| 7925 | Dormitory or Exit | | |
| 7943 | Apartment Corridor | \$756.00 | \$780.00 |
| 7945 | Dormitory or Exit | | |
| 7950 | Hotel Guest Lock | \$816.00 | \$840.00 |
| Double Cyl No Deadbolt | | | |
| 7916 | Apartment or Exit or Public Toilet | \$813.00 | \$837.00 |
| 7938 | Classroom Security Intruder | | |
| Double Cyl With Deadbolt | | | |
| 7926 | Store Door | \$829.00 | \$853.00 |
| Electro Mechanical Single Cyl – Specify 12V or 24V | | | |
| 7970-12V / 7970-24V | Fail Safe | \$1,023.00 | \$1,047.00 |
| 7971-12V / 7971-24V | Fail Secure | | |
| Electro Mechanical Double Cyl – Specify 12V or 24V | | | |
| 7972-12V / 7972-24V | Fail Safe | \$1,096.00 | \$1,120.00 |
| 7973-12V / 7973-24V | Fail Secure | | |
| Non Keyed | | | |
| 7915 | Passage or Closet | \$572.00 | \$596.00 |
| 7965 | Privacy Bedroom or Bath (Latch) | \$665.00 | \$689.00 |
| 7966 | Privacy Bedroom or Bath (Deadbolt) | \$702.00 | \$726.00 |
| 7993 | Single Dummy Trim | \$236.00 | \$248.00 |
| 7994 | Double Dummy Trim | \$475.00 | \$499.00 |
| 7995 | Single Dummy Trim w/Lockbody | \$321.00 | \$333.00 |

ML-134 MORTISE LOCKS

SARGENT®

ASSA ABLOY

OPTIONS

USA & Canada Prices Effective June 3, 2019

| Options | Description | Price |
|----------|---|--|
| 1▲ | 7900 Line with 1-1/16" wide front for 1-3/8" doors. | \$58.00 |
| 10▲ | SARGENT Signature Key System | \$58.00 / cyl. |
| 11†▲ | SARGENT XC Key System (not available with 10, 22, SC, SE options) | No addition |
| 1160 | SARGENT XC Large Format Interchangeable Plastic Disposable Construction Core | No addition |
| 1163 | SARGENT XC Large Format Interchangeable Core Cylinder - Includes masterkeying charges | \$77.00 |
| 1164 | SARGENT XC Large Format Interchangeable Construction Core Cylinder | \$77.00 |
| 1170 | Small Format interchangeable disposable construction core - to accept 7 Pin XC permanent core | No addition |
| 11727P | Small Format interchangeable keyed construction core - to accept 7 Pin XC permanent core | \$69.00 |
| 11737P | Small Format interchangeable core - to accept 7 pin XC permanent core | \$69.00 / cyl. |
| 21▲† | SARGENT Construction Key System (lost ball) Standard on all new systems established since 5/1/96 | \$16.00 / cyl. |
| 22▲† | SARGENT Construction Key System (split key) To be used on pre-established split key systems only | \$32.00 / cyl. |
| 31 | Thick Doors - Extended Lip Required - Specify Length C to E | |
| | - Cylinders - IMPORTANT- See catalog 7800/8200 option page for cylinder limitations | |
| | - Below charges DO NOT include additional charges for special cylinder requirements | |
| | Doors up to 2-1/2" thick - lock centered | No addition |
| | Doors 2-5/8" to 6" thick OR doors 1-3/4" thick w/max 1" paneling one side. | |
| | For example: Specify 1-3/4" door with panel (Side) on inside or outside | Non Keyed function \$50.00 Keyed function \$100.00 |
| 60 | SARGENT Large Format Interchangeable Plastic Disposable Construction Core | No addition |
| 63 | SARGENT Large Format Interchangeable core cylinder, includes master keying charges | \$77.00 / cyl. |
| 64 | SARGENT Large Format Interchangeable Construction Core Cylinder | \$77.00 |
| 6573▲† | Small Format 6-Pin Uncombined Core (Refer to CK-12) | \$59.00 / cyl. |
| 65737P▲† | Small Format 7-Pin Uncombined Core (Refer to CK-12) | \$59.00 / cyl. |
| 70▲† | Small Format Interchangeable disposable plastic construction core | No addition |
| 72▲† | Small Format Interchangeable 6-pin construction core (7-pin with 11 option) | \$69.00 |
| 73▲† | Small Format interchangeable core 6-pin Includes MK and GMK keying charges | \$69.00 / cyl |
| 737P▲† | Small Format interchangeable core 7-pin (refer to CK-12 for available keyways) Includes MK and GMK keying charges | \$69.00 / cyl |
| F182▲† | SARGENT Keso Security Cylinder – patented – new key systems | \$84.00 / cyl. |
| F183▲† | SARGENT Keso Security Removable Core Cylinder – patented – new key systems | \$120.00 / cyl. |
| 81▲† | Cylinder to accept Keso (83) and Keso F1(F183) Removable Core – no core provided | No addition |
| 82▲† | SARGENT Keso Security Cylinder (For existing systems only) | \$84.00 / cyl. |
| 83▲† | SARGENT Keso Security Removable Core Cylinder (For existing systems only) | \$120.00 / cyl. |
| 84▲† | SARGENT Keso Security Removable Construction Core Cylinder | See CK-18 |
| 85 | Tactile Warning - Abrasive coating on inside lever | \$45.00 |
| 86 | Tactile Warning - Abrasive coating on outside lever | \$45.00 |
| 87 | Tactile Warning - Abrasive coating on both levers | \$90.00 |
| BR | SARGENT Bump Resistant Cyls. (N/A w/10, 22, 30, 60, 63, 64, 70,72, 73, 737P, KESO, SC, SE) | \$23.00 /cyl. |
| DG1 | Patented Degree DG1 Key System | No Addition |
| DG160 | Hardware prepared for DG1-6300 Lg. Format IC cores, supplied with temporary plastic construction cores | No addition |
| DG163 | Patented Degree DG1 Large Format Interchangeable Core Cylinder - Includes master keying charges | \$77.00 |
| DG164 | Hardware prepared for DG1-6300 Lg. Format IC cores, supplied with temporary keyed construction cores | \$77.00 |
| DG2 | Patented Degree DG2 Key System incorporating a locking sidebar | \$58.00/cyl. |
| DG260 | Hardware prepared for DG2-6300 Lg. Format IC cores, supplied with temporary plastic construction cores | No addition |
| DG263 | Patented Degree DG2 Large Format Interchangeable Core Cylinder - Includes master keying charges | \$135.00 |
| DG264 | Hardware prepared for DG2-6300 Lg. Format IC cores, supplied with temporary keyed construction cores | \$77.00 |
| DG3 | Patented Degree DG3 Key System incorporating a locking sidebar and UL437 listed | \$82.00/cyl. |
| DG360 | Hardware prepared for DG3-6300 Lg. Format IC cores, supplied with temporary plastic construction cores | No addition |
| DG363 | Patented Degree DG3 Large Format Interchangeable Core Cylinder - Includes master keying charges | \$159.00 |
| DG364 | Hardware prepared for DG3-6300 Lg. Format IC cores, supplied with temporary keyed construction cores | \$77.00 |
| LC | Less Cylinder | -\$89.00/cyl. |
| OBS | Open Back Strike | \$73.00 |
| RX | Request to Exit | \$190.00 |
| SC▲† | Schlage "C" Keyway cylinder, (Number 41 Cylinder Only, 0 bitted) | No addition |
| SE▲† | Schlage "E" Keyway cylinder, (Number 41 Cylinder Only, 0 bitted) | No addition |
| SG | MicroShield® – an antimicrobial powder coat finish | \$67.00 |
| WBS | Wrought Box Strike | No addition |

NOTES: ▲ Options not available with a standard 50 function lockout cylinder. † Not available with 60, 63, 64 options.

| | | |
|-----|--|---------|
| CPC | 7904 x CEH001 x RH x 32D x CPC (Clear Powder Coat) All orders will continue to be handled as a "special" when CPC is ordered. | \$62.00 |
|-----|--|---------|

Escutcheon Design:

CE
TE
LE1

Lever Designs:

H001, H002



H001



H002

How to order:

60-7904 x CEH001 x RH x 26D
Option 60
Function 7904
Escutcheon CO
Lever H001
Hand RH
Finish 26D

| Function | | Finish | |
|---|------------------------------------|------------------|--|
| | | 10BE/26D/BSP/WSP | 03/04/09/10/10B/10BL/14/15/20D/26/32/32D |
| Single Cyl | | | |
| 7904 | Storeroom or Closet | | |
| 7937 | Classroom | \$819.00 | \$843.00 |
| 7955 | Office or Entry | | |
| Single Cyl With Deadbolt | | | |
| 7924 | Room Door | | |
| 7925 | Dormitory or Exit | | |
| 7943 | Apartment Corridor | \$834.00 | \$858.00 |
| 7945 | Dormitory or Exit | | |
| 7950 | Hotel Guest Lock | \$909.00 | \$933.00 |
| Double Cyl No Deadbolt | | | |
| 7916 | Apartment or Exit or Public Toilet | \$897.00 | \$921.00 |
| 7938 | Classroom Security Intruder | | |
| Double Cyl With Deadbolt | | | |
| 7926 | Store Door | \$914.00 | \$938.00 |
| Electro Mechanical Single Cyl – Specify 12V or 24V | | | |
| 7970-12V / 7970-24V | Fail Safe | \$1,108.00 | \$1,132.00 |
| 7971-12V / 7971-24V | Fail Secure | | |
| Electro Mechanical Double Cyl – Specify 12V or 24V | | | |
| 7972-12V / 7972-24V | Fail Safe | \$1,182.00 | \$1,206.00 |
| 7973-12V / 7973-24V | Fail Secure | | |
| Non Keyed | | | |
| 7915 | Passage or Closet | \$645.00 | \$669.00 |
| 7965 | Privacy Bedroom or Bath (Latch) | \$742.00 | \$766.00 |
| 7966 | Privacy Bedroom or Bath (Deadbolt) | \$775.00 | \$799.00 |
| 7993 | Single Dummy Trim | \$259.00 | \$283.00 |
| 7994 | Double Dummy Trim | \$537.00 | \$561.00 |
| 7995 | Single Dummy Trim w/Lockbody | \$340.00 | \$364.00 |

ML-136 MORTISE LOCKS

SARGENT®

ASSA ABLOY

OPTIONS

USA & Canada Prices Effective June 3, 2019

| Options | Description | Price |
|----------|---|--|
| 1▲ | 7900 Line with 1-1/16" wide front for 1-3/8" doors. | \$58.00 |
| 10▲ | SARGENT Signature Key System | \$58.00 / cyl. |
| 11†▲ | SARGENT XC Key System (not available with 10, 22, SC, SE options) | No addition |
| 1160 | SARGENT XC Large Format Interchangeable Plastic Disposable Construction Core | No addition |
| 1163 | SARGENT XC Large Format Interchangeable Core Cylinder - Includes masterkeying charges | \$77.00 |
| 1164 | SARGENT XC Large Format Interchangeable Construction Core Cylinder | \$77.00 |
| 1170 | Small Format interchangeable disposable construction core - to accept 7 Pin XC permanent core | No addition |
| 11727P | Small Format interchangeable keyed construction core - to accept 7 Pin XC permanent core | \$69.00 |
| 11737P | Small Format interchangeable core - to accept 7 pin XC permanent core | \$69.00 / cyl. |
| 21▲† | SARGENT Construction Key System (lost ball) Standard on all new systems established since 5/1/96 | \$16.00 / cyl. |
| 22▲† | SARGENT Construction Key System (split key) To be used on pre-established split key systems only | \$32.00 / cyl. |
| 31 | Thick Doors - Extended Lip Required - Specify Length C to E - Cylinders - IMPORTANT- See catalog 7800/8200 option page for cylinder limitations - Below charges DO NOT include additional charges for special cylinder requirements | |
| | Doors up to 2-1/2" thick - lock centered | No addition |
| | Doors 2-5/8" to 6" thick OR doors 1-3/4" thick w/max 1" paneling one side. For example: Specify 1-3/4" door with panel (Side) on inside or outside | Non Keyed function \$50.00 Keyed function \$100.00 |
| 60 | SARGENT Large Format Interchangeable Plastic Disposable Construction Core | No addition |
| 63 | SARGENT Large Format Interchangeable core cylinder, includes master keying charges | \$77.00 / cyl. |
| 64 | SARGENT Large Format Interchangeable Construction Core Cylinder | \$77.00 |
| 6573▲† | Small Format 6-Pin Uncombined Core (Refer to CK-12) | \$59.00 / cyl. |
| 65737P▲† | Small Format 7-Pin Uncombined Core (Refer to CK-12) | \$59.00 / cyl. |
| 70▲† | Small Format Interchangeable disposable plastic construction core | No addition |
| 72▲† | Small Format Interchangeable 6-pin construction core (7-pin with 11 option) | \$69.00 |
| 73▲† | Small Format interchangeable core 6-pin Includes MK and GMK keying charges | \$69.00 / cyl. |
| 737P▲† | Small Format interchangeable core 7-pin (refer to CK-12 for available keyways) Includes MK and GMK keying charges | \$69.00 / cyl. |
| F182▲† | SARGENT Keso Security Cylinder – patented – new key systems | \$84.00 / cyl. |
| F183▲† | SARGENT Keso Security Removable Core Cylinder – patented – new key systems | \$120.00 / cyl. |
| 81▲† | Cylinder to accept Keso (83) and Keso F1(F183) Removable Core – no core provided | No addition |
| 82▲† | SARGENT Keso Security Cylinder (For existing systems only) | \$84.00 / cyl. |
| 83▲† | SARGENT Keso Security Removable Core Cylinder (For existing systems only) | \$120.00 / cyl. |
| 84▲† | SARGENT Keso Security Removable Construction Core Cylinder | See CK-18 |
| 85 | Tactile Warning - Abrasive coating on inside lever | \$45.00 |
| 86 | Tactile Warning - Abrasive coating on outside lever | \$45.00 |
| 87 | Tactile Warning - Abrasive coating on both levers | \$90.00 |
| BR | SARGENT Bump Resistant Cyls. (N/A w/10, 22, 30, 60, 63, 64, 70,72, 73, 737P, KESO, SC, SE) | \$23.00 /cyl. |
| DG1 | Patented Degree DG1 Key System | No Addition |
| DG160 | Hardware prepared for DG1-6300 Lg. Format IC cores, supplied with temporary plastic construction cores | No addition |
| DG163 | Patented Degree DG1 Large Format Interchangeable Core Cylinder - Includes master keying charges | \$77.00 |
| DG164 | Hardware prepared for DG1-6300 Lg. Format IC cores, supplied with temporary keyed construction cores | \$77.00 |
| DG2 | Patented Degree DG2 Key System incorporating a locking sidebar | \$58.00/cyl. |
| DG260 | Hardware prepared for DG2-6300 Lg. Format IC cores, supplied with temporary plastic construction cores | No addition |
| DG263 | Patented Degree DG2 Large Format Interchangeable Core Cylinder - Includes master keying charges | \$135.00 |
| DG264 | Hardware prepared for DG2-6300 Lg. Format IC cores, supplied with temporary keyed construction cores | \$77.00 |
| DG3 | Patented Degree DG3 Key System incorporating a locking sidebar and UL437 listed | \$82.00/cyl. |
| DG360 | Hardware prepared for DG3-6300 Lg. Format IC cores, supplied with temporary plastic construction cores | No addition |
| DG363 | Patented Degree DG3 Large Format Interchangeable Core Cylinder - Includes master keying charges | \$159.00 |
| DG364 | Hardware prepared for DG3-6300 Lg. Format IC cores, supplied with temporary keyed construction cores | \$77.00 |
| LC | Less Cylinder | -\$89.00/cyl. |
| OBS | Open Back Strike | \$73.00 |
| RX | Request to Exit | \$190.00 |
| SC▲† | Schlage "C" Keyway cylinder, (Number 41 Cylinder Only, 0 bitted) | No addition |
| SE▲† | Schlage "E" Keyway cylinder, (Number 41 Cylinder Only, 0 bitted) | No addition |
| SG | MicroShield® – an antimicrobial powder coat finish | \$67.00 |
| WBS | Wrought Box Strike | No addition |

NOTES: ▲ Options not available with a standard 50 function lockout cylinder. † Not available with 60, 63, 64 options.

| | | |
|-----|--|---------|
| CPC | 7904 x CEH008 x RH x 32D x CPC (Clear Powder Coat) All orders will continue to be handled as a "special" when CPC is ordered. | \$62.00 |
|-----|--|---------|

Escutcheon Design:

CE
TE
LE1

Lever Designs:

H003, H004, H005, H006, H007, H008, H009, H010, H011



H007



H008

How to order:

21-7904 x CEH003 x RH x 10BE
Option 60
Function 7904
Escutcheon CE
Lever H008
Hand RH
Finish 10BE

| Function | | Finish | |
|---|------------------------------------|------------------|--|
| | | 10BE/26D/BSP/WSP | 03/04/09/10/10B/10BL/14/15/20D/26/32/32D |
| Single Cyl | | | |
| 7904 | Storeroom or Closet | | |
| 7937 | Classroom | \$897.00 | \$899.00 |
| 7955 | Office or Entry | | |
| Single Cyl With Deadbolt | | | |
| 7924 | Room Door | | |
| 7925 | Dormitory or Exit | | |
| 7943 | Apartment Corridor | \$916.00 | \$913.00 |
| 7945 | Dormitory or Exit | | |
| 7950 | Hotel Guest Lock | \$985.00 | \$983.00 |
| Double Cyl No Deadbolt | | | |
| 7916 | Apartment or Exit or Public Toilet | \$979.00 | \$973.00 |
| 7938 | Classroom Security Intruder | | |
| Double Cyl With Deadbolt | | | |
| 7926 | Store Door | \$994.00 | \$987.00 |
| Electro Mechanical Single Cyl – Specify 12V or 24V | | | |
| 7970-12V / 7970-24V | Fail Safe | \$1,183.00 | \$1,170.00 |
| 7971-12V / 7971-24V | Fail Secure | | |
| Electro Mechanical Double Cyl – Specify 12V or 24V | | | |
| 7972-12V / 7972-24V | Fail Safe | \$1,260.00 | \$1,239.00 |
| 7973-12V / 7973-24V | Fail Secure | | |
| Non Keyed | | | |
| 7915 | Passage or Closet | \$727.00 | \$738.00 |
| 7965 | Privacy Bedroom or Bath (Latch) | \$824.00 | \$827.00 |
| 7966 | Privacy Bedroom or Bath (Deadbolt) | \$858.00 | \$858.00 |
| 7993 | Single Dummy Trim | \$373.00 | \$385.00 |
| 7994 | Double Dummy Trim | \$622.00 | \$636.00 |
| 7995 | Single Dummy Trim w/Lockbody | \$457.00 | \$462.00 |

ML-138 MORTISE LOCKS

SARGENT®

ASSA ABLOY

OPTIONS

USA & Canada Prices Effective June 3, 2019

| Options | Description | Price |
|----------|---|--|
| 1▲ | 7900 Line with 1-1/16" wide front for 1-3/8" doors. | \$58.00 |
| 10▲ | SARGENT Signature Key System | \$58.00 / cyl. |
| 11†▲ | SARGENT XC Key System (not available with 10, 22, SC, SE options) | No addition |
| 1160 | SARGENT XC Large Format Interchangeable Plastic Disposable Construction Core | No addition |
| 1163 | SARGENT XC Large Format Interchangeable Core Cylinder - Includes masterkeying charges | \$77.00 |
| 1164 | SARGENT XC Large Format Interchangeable Construction Core Cylinder | \$77.00 |
| 1170 | Small Format interchangeable disposable construction core - to accept 7 Pin XC permanent core | No addition |
| 11727P | Small Format interchangeable keyed construction core - to accept 7 Pin XC permanent core | \$69.00 |
| 11737P | Small Format interchangeable core - to accept 7 pin XC permanent core | \$69.00 / cyl. |
| 21▲† | SARGENT Construction Key System (lost ball) Standard on all new systems established since 5/1/96 | \$16.00 / cyl. |
| 22▲† | SARGENT Construction Key System (split key) To be used on pre-established split key systems only | \$32.00 / cyl. |
| 31 | Thick Doors - Extended Lip Required - Specify Length C to E - Cylinders - IMPORTANT- See catalog 7800/8200 option page for cylinder limitations - Below charges DO NOT include additional charges for special cylinder requirements | |
| | Doors up to 2-1/2" thick - lock centered | No addition |
| | Doors 2-5/8" to 6" thick OR doors 1-3/4" thick w/max 1" paneling one side. For example: Specify 1-3/4" door with panel (Side) on inside or outside | Non Keyed function \$50.00 Keyed function \$100.00 |
| 60 | SARGENT Large Format Interchangeable Plastic Disposable Construction Core | No addition |
| 63 | SARGENT Large Format Interchangeable core cylinder, includes master keying charges | \$77.00 / cyl. |
| 64 | SARGENT Large Format Interchangeable Construction Core Cylinder | \$77.00 |
| 6573▲† | Small Format 6-Pin Uncombined Core (Refer to CK-12) | \$59.00 / cyl. |
| 65737P▲† | Small Format 7-Pin Uncombined Core (Refer to CK-12) | \$59.00 / cyl. |
| 70▲† | Small Format Interchangeable disposable plastic construction core | No addition |
| 72▲† | Small Format Interchangeable 6-pin construction core (7-pin with 11 option) | \$69.00 |
| 73▲† | Small Format interchangeable core 6-pin Includes MK and GMK keying charges | \$69.00 / cyl |
| 737P▲† | Small Format interchangeable core 7-pin (refer to CK-12 for available keyways) Includes MK and GMK keying charges | \$69.00 / cyl |
| F182▲† | SARGENT Keso Security Cylinder – patented – new key systems | \$84.00 / cyl. |
| F183▲† | SARGENT Keso Security Removable Core Cylinder – patented – new key systems | \$120.00 / cyl. |
| 81▲† | Cylinder to accept Keso (83) and Keso F1(F183) Removable Core – no core provided | No addition |
| 82▲† | SARGENT Keso Security Cylinder (For existing systems only) | \$84.00 / cyl. |
| 83▲† | SARGENT Keso Security Removable Core Cylinder (For existing systems only) | \$120.00 / cyl. |
| 84▲† | SARGENT Keso Security Removable Construction Core Cylinder | See CK-18 |
| 85 | Tactile Warning - Abrasive coating on inside lever | \$45.00 |
| 86 | Tactile Warning - Abrasive coating on outside lever | \$45.00 |
| 87 | Tactile Warning - Abrasive coating on both levers | \$90.00 |
| BR | SARGENT Bump Resistant Cyls. (N/A w/10, 22, 30, 60, 63, 64, 70,72, 73, 737P, KESO, SC, SE) | \$23.00 /cyl. |
| DG1 | Patented Degree DG1 Key System | No Addition |
| DG160 | Hardware prepared for DG1-6300 Lg. Format IC cores, supplied with temporary plastic construction cores | No addition |
| DG163 | Patented Degree DG1 Large Format Interchangeable Core Cylinder - Includes master keying charges | \$77.00 |
| DG164 | Hardware prepared for DG1-6300 Lg. Format IC cores, supplied with temporary keyed construction cores | \$77.00 |
| DG2 | Patented Degree DG2 Key System incorporating a locking sidebar | \$58.00/cyl. |
| DG260 | Hardware prepared for DG2-6300 Lg. Format IC cores, supplied with temporary plastic construction cores | No addition |
| DG263 | Patented Degree DG2 Large Format Interchangeable Core Cylinder - Includes master keying charges | \$135.00 |
| DG264 | Hardware prepared for DG2-6300 Lg. Format IC cores, supplied with temporary keyed construction cores | \$77.00 |
| DG3 | Patented Degree DG3 Key System incorporating a locking sidebar and UL437 listed | \$82.00/cyl. |
| DG360 | Hardware prepared for DG3-6300 Lg. Format IC cores, supplied with temporary plastic construction cores | No addition |
| DG363 | Patented Degree DG3 Large Format Interchangeable Core Cylinder - Includes master keying charges | \$159.00 |
| DG364 | Hardware prepared for DG3-6300 Lg. Format IC cores, supplied with temporary keyed construction cores | \$77.00 |
| LC | Less Cylinder | -\$89.00/cyl. |
| OBS | Open Back Strike | \$73.00 |
| RX | Request to Exit | \$190.00 |
| SC▲† | Schlage "C" Keyway cylinder, (Number 41 Cylinder Only, 0 bitted) | No addition |
| SE▲† | Schlage "E" Keyway cylinder, (Number 41 Cylinder Only, 0 bitted) | No addition |
| SG | MicroShield® – an antimicrobial powder coat finish | \$67.00 |
| WBS | Wrought Box Strike | No addition |

NOTES: ▲ Options not available with a standard 50 function lockout cylinder. † Not available with 60, 63, 64 options.

| | | |
|-----|--|---------|
| CPC | 7904 x CEMD x RH x 32D x CPC (Clear Powder Coat) All orders will continue to be handled as a "special" when CPC is ordered. | \$62.00 |
|-----|--|---------|

USA & Canada Prices Effective June 3, 2019

Escutcheon Design:

CE
TE
LE1

Studio Lever Designs:

All Studio Collection Levers (except Gramercy Series)

How to order:

21-7904 x CEMD x RH x 26D
Option 60
Function 7904
Rose CE
Lever MD
Hand RH
Finish 26D

| Function | | Finish | |
|---|------------------------------------|------------------|--|
| | | 10BE/26D/BSP/WSP | 03/04/09/10/10B/10BL/14/15/20D/26/32/32D |
| Single Cyl | | | |
| 7904 | Storeroom or Closet | | |
| 7937 | Classroom | \$772.00 | \$796.00 |
| 7955 | Office or Entry | | |
| Single Cyl With Deadbolt | | | |
| 7924 | Room Door | | |
| 7925 | Dormitory or Exit | | |
| 7943 | Apartment Corridor | \$791.00 | \$815.00 |
| 7945 | Dormitory or Exit | | |
| 7950 | Hotel Guest Lock | \$860.00 | \$884.00 |
| Double Cyl No Deadbolt | | | |
| 7916 | Apartment or Exit or Public Toilet | \$854.00 | \$878.00 |
| 7938 | Classroom Security Intruder | | |
| Double Cyl With Deadbolt | | | |
| 7926 | Store Door | \$869.00 | \$893.00 |
| Electro Mechanical Single Cyl – Specify 12V or 24V | | | |
| 7970-12V / 7970-24V | Fail Safe | \$1,058.00 | \$1,082.00 |
| 7971-12V / 7971-24V | Fail Secure | | |
| Electro Mechanical Double Cyl – Specify 12V or 24V | | | |
| 7972-12V / 7972-24V | Fail Safe | \$1,135.00 | \$1,159.00 |
| 7973-12V / 7973-24V | Fail Secure | | |
| Non Keyed | | | |
| 7915 | Passage or Closet | \$602.00 | \$626.00 |
| 7965 | Privacy Bedroom or Bath (Latch) | \$699.00 | \$723.00 |
| 7966 | Privacy Bedroom or Bath (Deadbolt) | \$733.00 | \$757.00 |
| 7993 | Single Dummy Trim | \$248.00 | \$260.00 |
| 7994 | Double Dummy Trim | \$497.00 | \$521.00 |
| 7995 | Single Dummy Trim w/Lockbody | \$332.00 | \$344.00 |

ML-140 MORTISE LOCKS

SARGENT®

OPTIONS

ASSA ABLOY

USA & Canada Prices Effective June 3, 2019

| Options | Description | Price |
|----------|---|--|
| 1▲ | 7900 Line with 1-1/16" wide front for 1-3/8" doors. | \$58.00 |
| 10▲ | SARGENT Signature Key System | \$58.00 / cyl. |
| 11†▲ | SARGENT XC Key System (not available with 10, 22, SC, SE options) | No addition |
| 1160 | SARGENT XC Large Format Interchangeable Plastic Disposable Construction Core | No addition |
| 1163 | SARGENT XC Large Format Interchangeable Core Cylinder - Includes masterkeying charges | \$77.00 |
| 1164 | SARGENT XC Large Format Interchangeable Construction Core Cylinder | \$77.00 |
| 1170 | Small Format interchangeable disposable construction core - to accept 7 Pin XC permanent core | No addition |
| 11727P | Small Format interchangeable keyed construction core - to accept 7 Pin XC permanent core | \$69.00 |
| 11737P | Small Format interchangeable core - to accept 7 pin XC permanent core | \$69.00 / cyl. |
| 21▲† | SARGENT Construction Key System (lost ball) Standard on all new systems established since 5/1/96 | \$16.00 / cyl. |
| 22▲† | SARGENT Construction Key System (split key) To be used on pre-established split key systems only | \$32.00 / cyl. |
| 31 | Thick Doors - Extended Lip Required - Specify Length C to E - Cylinders - IMPORTANT- See catalog 7800/8200 option page for cylinder limitations - Below charges DO NOT include additional charges for special cylinder requirements | |
| | Doors up to 2-1/2" thick - lock centered | No addition |
| | Doors 2-5/8" to 6" thick OR doors 1-3/4" thick w/max 1" paneling one side. For example: Specify 1-3/4" door with panel (Side) on inside or outside | Non Keyed function \$50.00 Keyed function \$100.00 |
| 60 | SARGENT Large Format Interchangeable Plastic Disposable Construction Core | No addition |
| 63 | SARGENT Large Format Interchangeable core cylinder, includes master keying charges | \$77.00 / cyl. |
| 64 | SARGENT Large Format Interchangeable Construction Core Cylinder | \$77.00 |
| 6573▲† | Small Format 6-Pin Uncombined Core (Refer to CK-12) | \$59.00 / cyl. |
| 65737P▲† | Small Format 7-Pin Uncombined Core (Refer to CK-12) | \$59.00 / cyl. |
| 70▲† | Small Format Interchangeable disposable plastic construction core | No addition |
| 72▲† | Small Format Interchangeable 6-pin construction core (7-pin with 11 options) | \$69.00 |
| 73▲† | Small Format interchangeable core 6-pin Includes MK and GMK keying charges | \$69.00 / cyl |
| 737P▲† | Small Format interchangeable core 7-pin (refer to CK-12 for available keyways) Includes MK and GMK keying charges | \$69.00 / cyl |
| F182▲† | SARGENT Keso Security Cylinder – patented – new key systems | \$84.00 / cyl. |
| F183▲† | SARGENT Keso Security Removable Core Cylinder – patented – new key systems | \$120.00 / cyl. |
| 81▲† | Cylinder to accept Keso (83) and Keso F1(F183) Removable Core – no core provided | No addition |
| 82▲† | SARGENT Keso Security Cylinder (For existing systems only) | \$84.00 / cyl. |
| 83▲† | SARGENT Keso Security Removable Core Cylinder (For existing systems only) | \$120.00 / cyl. |
| 84▲† | SARGENT Keso Security Removable Construction Core Cylinder | See CK-18 |
| BR | SARGENT Bump Resistant Cylinders (N/A w/10, 22, 30, 60, 63, 64, 70, 72, 73, 737P, KESO, SC, & SE options) | \$23.00 /cyl. |
| DG1 | Patented Degree DG1 Key System | No Addition |
| DG160 | Hardware prepared for DG1-6300 Lg. Format IC cores, supplied with temporary plastic construction cores | No addition |
| DG163 | Patented Degree DG1 Large Format Interchangeable Core Cylinder - Includes master keying charges | \$77.00 |
| DG164 | Hardware prepared for DG1-6300 Lg. Format IC cores, supplied with temporary keyed construction cores | \$77.00 |
| DG2 | Patented Degree DG2 Key System incorporating a locking sidebar | \$58.00/cyl. |
| DG260 | Hardware prepared for DG2-6300 Lg. Format IC cores, supplied with temporary plastic construction cores | No addition |
| DG263 | Patented Degree DG2 Large Format Interchangeable Core Cylinder - Includes master keying charges | \$135.00 |
| DG264 | Hardware prepared for DG2-6300 Lg. Format IC cores, supplied with temporary keyed construction cores | \$77.00 |
| DG3 | Patented Degree DG3 Key System incorporating a locking sidebar and UL437 listed | \$82.00/cyl. |
| DG360 | Hardware prepared for DG3-6300 Lg. Format IC cores, supplied with temporary plastic construction cores | No addition |
| DG363 | Patented Degree DG3 Large Format Interchangeable Core Cylinder - Includes master keying charges | \$159.00 |
| DG364 | Hardware prepared for DG3-6300 Lg. Format IC cores, supplied with temporary keyed construction cores | \$77.00 |
| LC | Less Cylinder | -\$89.00/cyl. |
| OBS | Open Back Strike | \$73.00 |
| RX | Request to Exit | \$190.00 |
| SC▲† | Schlage "C" Keyway cylinder, (Number 41 Cylinder Only, 0 bitted) | No addition |
| SE▲† | Schlage "E" Keyway cylinder, (Number 41 Cylinder Only, 0 bitted) | No addition |
| SG | MicroShield® – an antimicrobial powder coat finish | \$67.00 |
| T1 | Decorative thumbturn; backplate matches rose design chosen | No Addition |
| T2 | Decorative square thumbturn; backplate matches rose design chosen | No Addition |
| T3 | Decorative cylinder thumbturn; backplate matches rose design chosen | No Addition |
| WBS | Wrought Box Strike | No addition |

NOTES: ▲ Options not available with a standard 50 function lockout cylinder. † Not available with 60, 63, 64 options.

| | | |
|-----|--|---------|
| CPC | 7904 x OREM x RH x 32D x CPC (Clear Powder Coat) All orders will continue to be handled as a "special" when CPC is ordered. | \$62.00 |
|-----|--|---------|

USA & Canada Prices Effective June 3, 2019

Rose Design:

CO (2-3/4")
CR (2-3/16")
LN (2")
O (2-3/4")
TO (2-3/4")
TR (2-3/16")
E2 (2-11/16")
E3 (2-1/16")
E4 (3-1/3")

Lever Design:

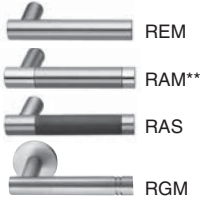

How to order Gramercy Series Levers:

Option: **21** x Function: **7904** x Rose: **CO** x Lever: **RAM** x Finish: **29BK29** x Hand: **RH**

See below for available finishes:

Lever Design Available Finishes

| Lever Design | Available Finishes |
|--------------|--------------------|
| REM-RGM | 2930 or 3030 |
| RAM | 2930* |
| RAS | 29BK29, 30BK30 |

*Two-tone - grip of lever is 32D, balance of lever is 32. Rose/escutcheon and lock finish will be 32.
See catalog for finish description.

**RAM is not available in 10BE/BSP/WSP finish.

| Function – Single Cylinder | Finish – 10BE/BSP/WSP/629/630 |
|--|-------------------------------|
| 7904 Storeroom or Closet | |
| 7937 Classroom | \$798.00 |
| 7955 Office or Entry | |
| Single Cylinder With Deadbolt | |
| 7924 Room Door | |
| 7925 Dormitory or Exit | |
| 7943 Apartment Corridor | \$820.00 |
| 7945 Dormitory or Exit | |
| 7950 Hotel Guest Lock | \$880.00 |
| Double Cylinder No Deadbolt | |
| 7916 Apartment or Exit or Public Toilet | \$877.00 |
| 7938 Classroom Security Intruder | |
| Double Cylinder With Deadbolt | |
| 7926 Store Door | \$893.00 |
| Electro Mechanical Single Cylinder – Specify 12V or 24V | |
| 7970-12V / 7970-24V Fail Safe | \$1,085.00 |
| 7971-12V / 7971-24V Fail Secure | |
| Electro Mechanical Double Cylinder – Specify 12V or 24V | |
| 7972-12V / 7972-24V Fail Safe | \$1,163.00 |
| 7973-12V / 7973-24V Fail Secure | |
| Non Keyed | |
| 7915 Passage or Closet | \$638.00 |
| 7965 Privacy Bedroom or Bath (Latch) | \$728.00 |
| 7966 Privacy Bedroom or Bath (Deadbolt) | \$763.00 |
| 7993 Single Dummy Trim | \$267.00 |
| 7994 Double Dummy Trim | \$531.00 |
| 7995 Single Dummy Trim w/Lockbody | \$350.00 |

ML-142 MORTISE LOCKS

SARGENT®

OPTIONS

ASSA ABLOY

USA & Canada Prices Effective June 3, 2019

| Options | Description | Price |
|----------|---|--|
| 1▲ | 7900 Line with 1-1/16" wide front for 1-3/8" doors. | \$58.00 |
| 10▲ | SARGENT Signature Key System | \$58.00 / cyl. |
| 11†▲ | SARGENT XC Key System (not available with 10, 22, SC, SE options) | No addition |
| 1160 | SARGENT XC Large Format Interchangeable Plastic Disposable Construction Core | No addition |
| 1163 | SARGENT XC Large Format Interchangeable Core Cylinder - Includes masterkeying charges | \$77.00 |
| 1164 | SARGENT XC Large Format Interchangeable Construction Core Cylinder | \$77.00 |
| 1170 | Small Format interchangeable disposable construction core - to accept 7 Pin XC permanent core | No addition |
| 11727P | Small Format interchangeable keyed construction core - to accept 7 Pin XC permanent core | \$69.00 |
| 11737P | Small Format interchangeable core - to accept 7 pin XC permanent core | \$69.00 / cyl. |
| 21▲† | SARGENT Construction Key System (lost ball) Standard on all new systems established since 5/1/96 | \$16.00 / cyl. |
| 22▲† | SARGENT Construction Key System (split key) To be used on pre-established split key systems only | \$32.00 / cyl. |
| 31 | Thick Doors - Extended Lip Required - Specify Length C to E - Cylinders - IMPORTANT- See catalog 7800/8200 option page for cylinder limitations - Below charges DO NOT include additional charges for special cylinder requirements | |
| | Doors up to 2-1/2" thick - lock centered | No addition |
| | Doors 2-5/8" to 6" thick OR doors 1-3/4" thick w/max 1" paneling one side. For example: Specify 1-3/4" door with panel (Side) on inside or outside | Non Keyed function \$50.00 Keyed function \$100.00 |
| 60 | SARGENT Large Format Interchangeable Plastic Disposable Construction Core | No addition |
| 63 | SARGENT Large Format Interchangeable core cylinder, includes master keying charges | \$77.00 / cyl. |
| 64 | SARGENT Large Format Interchangeable Construction Core Cylinder | \$77.00 |
| 6573▲† | Small Format 6-Pin Uncombined Core (Refer to CK-12) | \$59.00 / cyl. |
| 65737P▲† | Small Format 7-Pin Uncombined Core (Refer to CK-12) | \$59.00 / cyl. |
| 70▲† | Small Format Interchangeable disposable plastic construction core | No addition |
| 72▲† | Small Format Interchangeable 6-pin construction core (7-pin with 11 options) | \$69.00 |
| 73▲† | Small Format interchangeable core 6-pin Includes MK and GMK keying charges | \$69.00 / cyl |
| 737P▲† | Small Format interchangeable core 7-pin (refer to CK-12 for available keyways) Includes MK and GMK keying charges | \$69.00 / cyl |
| F182▲† | SARGENT Keso Security Cylinder – patented – new key systems | \$84.00 / cyl. |
| F183▲† | SARGENT Keso Security Removable Core Cylinder – patented – new key systems | \$120.00 / cyl. |
| 81▲† | Cylinder to accept Keso (83) and Keso F1(F183) Removable Core – no core provided | No addition |
| 82▲† | SARGENT Keso Security Cylinder (For existing systems only) | \$84.00 / cyl. |
| 83▲† | SARGENT Keso Security Removable Core Cylinder (For existing systems only) | \$120.00 / cyl. |
| 84▲† | SARGENT Keso Security Removable Construction Core Cylinder | See CK-18 |
| BR | SARGENT Bump Resistant Cylinders (N/A w/10, 22, 30, 60, 63, 64, 70, 72, 73, 737P, KESO, SC, & SE options) | \$23.00 /cyl. |
| DG1 | Patented Degree DG1 Key System | No Addition |
| DG160 | Hardware prepared for DG1-6300 Lg. Format IC cores, supplied with temporary plastic construction cores | No addition |
| DG163 | Patented Degree DG1 Large Format Interchangeable Core Cylinder - Includes master keying charges | \$77.00 |
| DG164 | Hardware prepared for DG1-6300 Lg. Format IC cores, supplied with temporary keyed construction cores | \$77.00 |
| DG2 | Patented Degree DG2 Key System incorporating a locking sidebar | \$58.00/cyl. |
| DG260 | Hardware prepared for DG2-6300 Lg. Format IC cores, supplied with temporary plastic construction cores | No addition |
| DG263 | Patented Degree DG2 Large Format Interchangeable Core Cylinder - Includes master keying charges | \$135.00 |
| DG264 | Hardware prepared for DG2-6300 Lg. Format IC cores, supplied with temporary keyed construction cores | \$77.00 |
| DG3 | Patented Degree DG3 Key System incorporating a locking sidebar and UL437 listed | \$82.00/cyl. |
| DG360 | Hardware prepared for DG3-6300 Lg. Format IC cores, supplied with temporary plastic construction cores | No addition |
| DG363 | Patented Degree DG3 Large Format Interchangeable Core Cylinder - Includes master keying charges | \$159.00 |
| DG364 | Hardware prepared for DG3-6300 Lg. Format IC cores, supplied with temporary keyed construction cores | \$77.00 |
| LC | Less Cylinder | -\$89.00/cyl. |
| OBS | Open Back Strike | \$73.00 |
| RX | Request to Exit | \$190.00 |
| SC▲† | Schlage "C" Keyway cylinder, (Number 41 Cylinder Only, 0 bitted) | No addition |
| SE▲† | Schlage "E" Keyway cylinder, (Number 41 Cylinder Only, 0 bitted) | No addition |
| SG | MicroShield® – an antimicrobial powder coat finish | \$67.00 |
| T1 | Decorative thumbturn; backplate matches rose design chosen | No Addition |
| T2 | Decorative square thumbturn; backplate matches rose design chosen | No Addition |
| T3 | Decorative cylinder thumbturn; backplate matches rose design chosen | No Addition |
| WBS | Wrought Box Strike | No addition |

NOTES: ▲ Options not available with a standard 50 function lockout cylinder. † Not available with 60, 63, 64 options.

| | | |
|-----|--|---------|
| CPC | 7904 x ORCM x RH x 32D x CPC (Clear Powder Coat) All orders will continue to be handled as a "special" when CPC is ordered. | \$62.00 |
|-----|--|---------|

USA & Canada Prices Effective June 3, 2019

Rose Design:

- CO (2-3/4")
- CR (2-3/16")
- LN (2")
- O (2-3/4")
- TO (2-3/4")
- TR (2-3/16")
- E2 (2-11/16")
- E3 (2-1/16")
- E4 (3-1/3")

Lever Design:

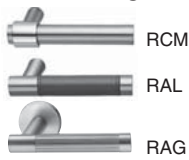

How to order Gramercy Series Levers:

Option: 63 x Function: 7904 x Rose: TR x Lever: RAL x Finish: 29BK29 x Hand: RH

See below for available finishes:

Lever Design Available Finishes

- RCM 2929, 3030, or 2930*
- RAL 29BK29, 29BN29, 30BK30, or 30BN30
- RAG 2929 or 3030

*Two-tone - grip of lever is 32D, balance of lever is 32. Rose/escutcheon and lock finish will be 32. See catalog for finish description.

| Function – Single Cylinder | | Finish – 10BE/BSP/WSP/629/630 |
|---|------------------------------------|-------------------------------|
| 7904 | Storeroom or Closet | |
| 7937 | Classroom | \$857.00 |
| 7955 | Office or Entry | |
| Single Cylinder With Deadbolt | | |
| 7924 | Room Door | |
| 7925 | Dormitory or Exit | |
| 7943 | Apartment Corridor | \$877.00 |
| 7945 | Dormitory or Exit | |
| 7950 | Hotel Guest Lock | \$937.00 |
| Double Cylinder No Deadbolt | | |
| 7916 | Apartment or Exit or Public Toilet | \$933.00 |
| 7938 | Classroom Security Intruder | |
| Double Cylinder With Deadbolt | | |
| 7926 | Store Door | \$944.00 |
| Electro Mechanical Single Cylinder – Specify 12V or 24V | | |
| 7970-12V / 7970-24V | Fail Safe | \$1,127.00 |
| 7971-12V / 7971-24V | Fail Secure | |
| Electro Mechanical Double Cylinder – Specify 12V or 24V | | |
| 7972-12V / 7972-24V | Fail Safe | \$1,197.00 |
| 7973-12V / 7973-24V | Fail Secure | |
| Non Keyed | | |
| 7915 | Passage or Closet | \$706.00 |
| 7965 | Privacy Bedroom or Bath (Latch) | \$794.00 |
| 7966 | Privacy Bedroom or Bath (Deadbolt) | \$825.00 |
| 7993 | Single Dummy Trim | \$367.00 |
| 7994 | Double Dummy Trim | \$610.00 |
| 7995 | Single Dummy Trim w/Lockbody | \$445.00 |

ML-144 MORTISE LOCKS

SARGENT®

ASSA ABLOY

OPTIONS

USA & Canada Prices Effective June 3, 2019

| Options | Description | Price |
|----------|---|--|
| 1▲ | 7900 Line with 1-1/16" wide front for 1-3/8" doors. | \$58.00 |
| 10▲ | SARGENT Signature Key System | \$58.00 / cyl. |
| 11†▲ | SARGENT XC Key System (not available with 10, 22, SC, SE options) | No addition |
| 1160 | SARGENT XC Large Format Interchangeable Plastic Disposable Construction Core | No addition |
| 1163 | SARGENT XC Large Format Interchangeable Core Cylinder - Includes masterkeying charges | \$77.00 |
| 1164 | SARGENT XC Large Format Interchangeable Construction Core Cylinder | \$77.00 |
| 1170 | Small Format interchangeable disposable construction core - to accept 7 Pin XC permanent core | No addition |
| 11727P | Small Format interchangeable keyed construction core - to accept 7 Pin XC permanent core | \$69.00 |
| 11737P | Small Format interchangeable core - to accept 7 pin XC permanent core | \$69.00 / cyl. |
| 21▲† | SARGENT Construction Key System (lost ball) Standard on all new systems established since 5/1/96 | \$16.00 / cyl. |
| 22▲† | SARGENT Construction Key System (split key) To be used on pre-established split key systems only | \$32.00 / cyl. |
| 31 | Thick Doors - Extended Lip Required - Specify Length C to E - Cylinders - IMPORTANT- See catalog 7800/8200 option page for cylinder limitations - Below charges DO NOT include additional charges for special cylinder requirements | |
| | Doors up to 2-1/2" thick - lock centered | No addition |
| | Doors 2-5/8" to 6" thick OR doors 1-3/4" thick w/max 1" paneling one side. For example: Specify 1-3/4" door with panel (Side) on inside or outside | Non Keyed function \$50.00 Keyed function \$100.00 |
| 60 | SARGENT Large Format Interchangeable Plastic Disposable Construction Core | No addition |
| 63 | SARGENT Large Format Interchangeable core cylinder, includes master keying charges | \$77.00 / cyl. |
| 64 | SARGENT Large Format Interchangeable Construction Core Cylinder | \$77.00 |
| 6573▲† | Small Format 6-Pin Uncombined Core (Refer to CK-12) | \$59.00 / cyl. |
| 65737P▲† | Small Format 7-Pin Uncombined Core (Refer to CK-12) | \$59.00 / cyl. |
| 70▲† | Small Format Interchangeable disposable plastic construction core | No addition |
| 72▲† | Small Format Interchangeable 6-pin construction core (7-pin with 11 option) | \$69.00 |
| 73▲† | Small Format interchangeable core 6-pin Includes MK and GMK keying charges | \$69.00 / cyl. |
| 737P▲† | Small Format interchangeable core 7-pin (refer to CK-12 for available keyways) Includes MK and GMK keying charges | \$69.00 / cyl. |
| F182▲† | SARGENT Keso Security Cylinder – patented – new key systems | \$84.00 / cyl. |
| F183▲† | SARGENT Keso Security Removable Core Cylinder – patented – new key systems | \$120.00 / cyl. |
| 81▲† | Cylinder to accept Keso (83) and Keso F1(F183) Removable Core – no core provided | No addition |
| 82▲† | SARGENT Keso Security Cylinder (For existing systems only) | \$84.00 / cyl. |
| 83▲† | SARGENT Keso Security Removable Core Cylinder (For existing systems only) | \$120.00 / cyl. |
| 84▲† | SARGENT Keso Security Removable Construction Core Cylinder | See CK-18 |
| BR | SARGENT Bump Resistant Cyls. (N/A w/10, 22, 30, 60, 63, 64, 70,72, 73, 737P, KESO, SC, SE) | \$23.00 /cyl. |
| DG1 | Patented Degree DG1 Key System | No Addition |
| DG160 | Hardware prepared for DG1-6300 Lg. Format IC cores, supplied with temporary plastic construction cores | No addition |
| DG163 | Patented Degree DG1 Large Format Interchangeable Core Cylinder - Includes master keying charges | \$77.00 |
| DG164 | Hardware prepared for DG1-6300 Lg. Format IC cores, supplied with temporary keyed construction cores | \$77.00 |
| DG2 | Patented Degree DG2 Key System incorporating a locking sidebar | \$58.00/cyl. |
| DG260 | Hardware prepared for DG2-6300 Lg. Format IC cores, supplied with temporary plastic construction cores | No addition |
| DG263 | Patented Degree DG2 Large Format Interchangeable Core Cylinder - Includes master keying charges | \$135.00 |
| DG264 | Hardware prepared for DG2-6300 Lg. Format IC cores, supplied with temporary keyed construction cores | \$77.00 |
| DG3 | Patented Degree DG3 Key System incorporating a locking sidebar and UL437 listed | \$82.00/cyl. |
| DG360 | Hardware prepared for DG3-6300 Lg. Format IC cores, supplied with temporary plastic construction cores | No addition |
| DG363 | Patented Degree DG3 Large Format Interchangeable Core Cylinder - Includes master keying charges | \$159.00 |
| DG364 | Hardware prepared for DG3-6300 Lg. Format IC cores, supplied with temporary keyed construction cores | \$77.00 |
| LC | Less Cylinder | -\$89.00/cyl. |
| OBS | Open Back Strike | \$73.00 |
| RX | Request to Exit | \$190.00 |
| SC▲† | Schlage "C" Keyway cylinder, (Number 41 Cylinder Only, 0 bitted) | No addition |
| SE▲† | Schlage "E" Keyway cylinder, (Number 41 Cylinder Only, 0 bitted) | No addition |
| SG | MicroShield® – an antimicrobial powder coat finish | \$67.00 |
| WBS | Wrought Box Strike | No addition |

NOTES: ▲ Options not available with a standard 50 function lockout cylinder. † Not available with 60, 63, 64 options.

| | | |
|-----|---|---------|
| CPC | 7904 x LW1MC x RH x 32D x CPC (Clear Powder Coat) All orders will continue to be handled as a "special" when CPC is ordered. | \$62.00 |
|-----|---|---------|

7900 SERIES — STUDIO COLLECTION GRAMERCY SERIES

USA & Canada Prices Effective June 3, 2019

Esc. Design:

CE
TE
LE1

Lever Design:

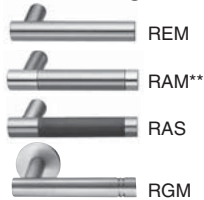

How to order Gramercy Series Levers:

Option: LC x Function: 7904 x Esc.: CE x Lever: REM x Finish: 29BK29 x Hand: RH

See below for available finishes:

Lever Design Available Finishes

| | |
|---------|----------------|
| REM-RGM | 2930 or 3030 |
| RAM | 2930* |
| RAS | 29BK29, 30BK30 |

*Two-tone - grip of lever is 32D, balance of lever is 32. Rose/escutcheon and lock finish will be 32.
See catalog for finish description.

**RAM is not available in 10BE/BSP/WSP finish

| Function – Single Cylinder | | Finish – 10BE/BSP/WSP/629/630 |
|--|------------------------------------|-------------------------------|
| 7904 | Storeroom or Closet | |
| 7937 | Classroom | \$843.00 |
| 7955 | Office or Entry | |
| Single Cyl With Deadbolt | | |
| 7924 | Room Door | |
| 7925 | Dormitory or Exit | |
| 7943 | Apartment Corridor | \$858.00 |
| 7945 | Dormitory or Exit | |
| 7950 | Hotel Guest Lock | \$933.00 |
| Double Cyl No Deadbolt | | |
| 7916 | Apartment or Exit or Public Toilet | \$921.00 |
| 7938 | Classroom Security Intruder | |
| Double Cyl With Deadbolt | | |
| 7926 | Store Door | \$938.00 |
| Electro Mechanical Single Cyl – Specify 12V or 24V | | |
| 7970-12V / 7970-24V | Fail Safe | \$1,132.00 |
| 7971-12V / 7971-24V | Fail Secure | |
| Electro Mechanical Double Cyl – Specify 12V or 24V | | |
| 7972-12V / 7972-24V | Fail Safe | \$1,206.00 |
| 7973-12V / 7973-24V | Fail Secure | |
| Non Keyed | | |
| 7915 | Passage or Closet | \$669.00 |
| 7965 | Privacy Bedroom or Bath (Latch) | \$766.00 |
| 7966 | Privacy Bedroom or Bath (Deadbolt) | \$799.00 |
| 7993 | Single Dummy Trim | \$283.00 |
| 7994 | Double Dummy Trim | \$561.00 |
| 7995 | Single Dummy Trim w/Lockbody | \$364.00 |

ML-146 MORTISE LOCKS

SARGENT®

ASSA ABLOY

OPTIONS

USA & Canada Prices Effective June 3, 2019

| Options | Description | Price |
|----------|---|---|
| 1▲ | 7900 Line with 1-1/16" wide front for 1-3/8" doors. | \$58.00 |
| 10▲ | SARGENT Signature Key System | \$58.00 / cyl. |
| 11†▲ | SARGENT XC Key System (not available with 10, 22, SC, SE options) | No addition |
| 1160 | SARGENT XC Large Format Interchangeable Plastic Disposable Construction Core | No addition |
| 1163 | SARGENT XC Large Format Interchangeable Core Cylinder - Includes masterkeying charges | \$77.00 |
| 1164 | SARGENT XC Large Format Interchangeable Construction Core Cylinder | \$77.00 |
| 1170 | Small Format interchangeable disposable construction core - to accept 7 Pin XC permanent core | No addition |
| 11727P | Small Format interchangeable keyed construction core - to accept 7 Pin XC permanent core | \$69.00 |
| 11737P | Small Format interchangeable core - to accept 7 pin XC permanent core | \$69.00 / cyl. |
| 21▲† | SARGENT Construction Key System (lost ball) Standard on all new systems established since 5/1/96 | \$16.00 / cyl. |
| 22▲† | SARGENT Construction Key System (split key) To be used on pre-established split key systems only | \$32.00 / cyl. |
| 31 | Thick Doors - Extended Lip Required - Specify Length C to E | |
| | - Cylinders - IMPORTANT- See catalog 7800/8200 option page for cylinder limitations | |
| | - Below charges DO NOT include additional charges for special cylinder requirements | |
| | Doors up to 2-1/2" thick - lock centered | No addition |
| | Doors 2-5/8" to 6" thick OR doors 1-3/4" thick w/max 1" paneling one side. | |
| | For example: Specify 1-3/4" door with panel (Side) on inside or outside | Non Keyed function \$50.00 Keyed function \$100.00 |
| 60 | SARGENT Large Format Interchangeable Plastic Disposable Construction Core | No addition |
| 63 | SARGENT Large Format Interchangeable core cylinder, includes master keying charges | \$77.00 / cyl. |
| 64 | SARGENT Large Format Interchangeable Construction Core Cylinder | \$77.00 |
| 6573▲† | Small Format 6-Pin Uncombined Core (Refer to CK-12) | \$59.00 / cyl. |
| 65737P▲† | Small Format 7-Pin Uncombined Core (Refer to CK-12) | \$59.00 / cyl. |
| 70▲† | Small Format Interchangeable disposable plastic construction core | No addition |
| 72▲† | Small Format Interchangeable 6-pin construction core (7-pin with 11 option) | \$69.00 |
| 73▲† | Small Format interchangeable core 6-pin Includes MK and GMK keying charges | \$69.00 / cyl |
| 737P▲† | Small Format interchangeable core 7-pin (refer to CK-12 for available keyways) Includes MK and GMK keying charges | \$69.00 / cyl |
| F182▲† | SARGENT Keso Security Cylinder – patented – new key systems | \$84.00 / cyl. |
| F183▲† | SARGENT Keso Security Removable Core Cylinder – patented – new key systems | \$120.00 / cyl. |
| 81▲† | Cylinder to accept Keso (83) and Keso F1(F183) Removable Core – no core provided | No addition |
| 82▲† | SARGENT Keso Security Cylinder (For existing systems only) | \$84.00 / cyl. |
| 83▲† | SARGENT Keso Security Removable Core Cylinder (For existing systems only) | \$120.00 / cyl. |
| 84▲† | SARGENT Keso Security Removable Construction Core Cylinder | See CK-18 |
| BR | SARGENT Bump Resistant Cyls. (N/A w/10, 22, 30, 60, 63, 64, 70,72, 73, 737P, KESO, SC, SE | \$23.00 /cyl. |
| DG1 | Patented Degree DG1 Key System | No Addition |
| DG160 | Hardware prepared for DG1-6300 Lg. Format IC cores, supplied with temporary plastic construction cores | No addition |
| DG163 | Patented Degree DG1 Large Format Interchangeable Core Cylinder - Includes master keying charges | \$77.00 |
| DG164 | Hardware prepared for DG1-6300 Lg. Format IC cores, supplied with temporary keyed construction cores | \$77.00 |
| DG2 | Patented Degree DG2 Key System incorporating a locking sidebar | \$58.00/cyl. |
| DG260 | Hardware prepared for DG2-6300 Lg. Format IC cores, supplied with temporary plastic construction cores | No addition |
| DG263 | Patented Degree DG2 Large Format Interchangeable Core Cylinder - Includes master keying charges | \$135.00 |
| DG264 | Hardware prepared for DG2-6300 Lg. Format IC cores, supplied with temporary keyed construction cores | \$77.00 |
| DG3 | Patented Degree DG3 Key System incorporating a locking sidebar and UL437 listed | \$82.00/cyl. |
| DG360 | Hardware prepared for DG3-6300 Lg. Format IC cores, supplied with temporary plastic construction cores | No addition |
| DG363 | Patented Degree DG3 Large Format Interchangeable Core Cylinder - Includes master keying charges | \$159.00 |
| DG364 | Hardware prepared for DG3-6300 Lg. Format IC cores, supplied with temporary keyed construction cores | \$77.00 |
| LC | Less Cylinder | -\$89.00/cyl. |
| OBS | Open Back Strike | \$73.00 |
| RX | Request to Exit | \$190.00 |
| SC▲† | Schlage "C" Keyway cylinder, (Number 41 Cylinder Only, 0 bitted) | No addition |
| SE▲† | Schlage "E" Keyway cylinder, (Number 41 Cylinder Only, 0 bitted) | No addition |
| SG | MicroShield® – an antimicrobial powder coat finish | \$67.00 |
| WBS | Wrought Box Strike | No addition |

NOTES: ▲ Options not available with a standard 50 function lockout cylinder. † Not available with 60, 63, 64 options.

| | | |
|-----|---|---------|
| CPC | 7904 x CERCM x RH x 32D x CPC (Clear Powder Coat) All orders will continue to be handled as a "special" when CPC is ordered. | \$62.00 |
|-----|---|---------|

7900 SERIES — STUDIO COLLECTION GRAMERCY SERIES

USA & Canada Prices Effective June 3, 2019

Esc. Design:

CE
TE
LE1

Lever Design:

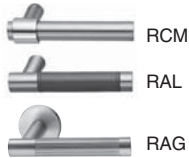

How to order Gramercy Series Levers:

Option: 21 x Function: 7904 x Esc.: TE x Lever: RCM x Finish: 3030 x Hand: RH

See below for available finishes:

Lever Design Available Finishes

RCM 2929, 3030, or 2930*
RAL 29BK29, 29BN29, 30BK30, or 30BN30
RAG 2929 or 3030

*Two-tone - grip of lever is 32D, balance of lever is 32. Rose/escutcheon and lock finish will be 32. See catalog for finish description.

| Function – Single Cylinder | | Finish – 10BE/BSP/WSP/629/630 |
|---|------------------------------------|-------------------------------|
| 7904 | Storeroom or Closet | |
| 7937 | Classroom | \$899.00 |
| 7955 | Office or Entry | |
| Single Cylinder With Deadbolt | | |
| 7924 | Room Door | |
| 7925 | Dormitory or Exit | |
| 7943 | Apartment Corridor | \$913.00 |
| 7945 | Dormitory or Exit | |
| 7950 | Hotel Guest Lock | \$983.00 |
| Double Cylinder No Deadbolt | | |
| 7916 | Apartment or Exit or Public Toilet | \$973.00 |
| 7938 | Classroom Security Intruder | |
| Double Cylinder With Deadbolt | | |
| 7926 | Store Door | \$987.00 |
| Electro Mechanical Single Cyl – Specify 12V or 24V | | |
| 7970-12V / 7970-24V | Fail Safe | |
| 7971-12V / 7971-24V | Fail Secure | \$1,170.00 |
| Electro Mechanical Double Cylinder – Specify 12V or 24V | | |
| 7972-12V / 7972-24V | Fail Safe | |
| 7973-12V / 7973-24V | Fail Secure | \$1,239.00 |
| Non Keyed | | |
| 7915 | Passage or Closet | \$738.00 |
| 7965 | Privacy Bedroom or Bath (Latch) | \$827.00 |
| 7966 | Privacy Bedroom or Bath (Deadbolt) | \$858.00 |
| 7993 | Single Dummy Trim | \$385.00 |
| 7994 | Double Dummy Trim | \$636.00 |
| 7995 | Single Dummy Trim w/Lockbody | \$462.00 |

ML-148 MORTISE LOCKS

SARGENT®

ASSA ABLOY

OPTIONS

USA & Canada Prices Effective June 3, 2019

| Options | Description | Price |
|----------|---|---|
| 1▲ | 7900 Line with 1-1/16" wide front for 1-3/8" doors. | \$58.00 |
| 10▲ | SARGENT Signature Key System | \$58.00 / cyl. |
| 11†▲ | SARGENT XC Key System (not available with 10, 22, SC, SE options) | No addition |
| 1160 | SARGENT XC Large Format Interchangeable Plastic Disposable Construction Core | No addition |
| 1163 | SARGENT XC Large Format Interchangeable Core Cylinder - Includes masterkeying charges | \$77.00 |
| 1164 | SARGENT XC Large Format Interchangeable Construction Core Cylinder | \$77.00 |
| 1170 | Small Format interchangeable disposable construction core - to accept 7 Pin XC permanent core | No addition |
| 11727P | Small Format interchangeable keyed construction core - to accept 7 Pin XC permanent core | \$69.00 |
| 11737P | Small Format interchangeable core - to accept 7 pin XC permanent core | \$69.00 / cyl. |
| 21▲† | SARGENT Construction Key System (lost ball) Standard on all new systems established since 5/1/96 | \$16.00 / cyl. |
| 22▲† | SARGENT Construction Key System (split key) To be used on pre-established split key systems only | \$32.00 / cyl. |
| 31 | Thick Doors - Extended Lip Required - Specify Length C to E - Cylinders - IMPORTANT- See catalog 7800/8200 option page for cylinder limitations - Below charges DO NOT include additional charges for special cylinder requirements | No addition |
| | Doors up to 2-1/2" thick - lock centered | No addition |
| | Doors 2-5/8" to 6" thick OR doors 1-3/4" thick w/max 1" paneling one side. For example: Specify 1-3/4" door with panel (Side) on inside or outside | Non Keyed function \$50.00 Keyed function \$100.00 |
| 36 | 6 Lobe security head screws | \$23.00 |
| 37 | Spanner head screws | \$16.00 |
| 60 | SARGENT Large Format Interchangeable Plastic Disposable Construction Core | No addition |
| 63 | SARGENT Large Format Interchangeable core cylinder, includes master keying charges | \$77.00 / cyl. |
| 64 | SARGENT Large Format Interchangeable Construction Core Cylinder | \$77.00 |
| 6573▲† | Small Format 6-Pin Uncombined Core (Refer to CK-12) | \$59.00 / cyl. |
| 65737P▲† | Small Format 7-Pin Uncombined Core (Refer to CK-12) | \$59.00 / cyl. |
| 70▲† | Small Format Interchangeable disposable plastic construction core | No addition |
| 72▲† | Small Format Interchangeable 6-pin construction core (7-pin with 11) | \$69.00 |
| 73▲† | Small Format interchangeable core 6-pin Includes MK and GMK keying charges | \$69.00 / cyl |
| 737P▲† | Small Format interchangeable core 7-pin (refer to CK-12 for available keyways) Includes MK and GMK keying charges | \$69.00 / cyl |
| 75 | Tactile Warning - Milled Inside Knob | \$72.00 |
| 76 | Tactile Warning - Milled Outside Knob | \$72.00 |
| 77 | Tactile Warning - Milled Outside and Inside Knob | \$144.00 |
| F182▲† | SARGENT Keso Security Cylinder – patented – new key systems | \$84.00 / cyl. |
| F183▲† | SARGENT Keso Security Removable Core Cylinder – patented – new key systems | \$120.00 / cyl. |
| 81▲† | Cylinder to accept Keso (83) and Keso F1(F183) Removable Core – no core provided | No addition |
| 82▲† | SARGENT Keso Security Cylinder (For existing systems only) | \$84.00 / cyl. |
| 83▲† | SARGENT Keso Security Removable Core Cylinder (For existing systems only) | \$120.00 / cyl. |
| 84▲† | SARGENT Keso Security Removable Construction Core Cylinder | See CK-18 |
| 85 | Tactile Warning - Abrasive Coating on Inside Knob | \$45.00 |
| 86 | Tactile Warning - Abrasive Coating on Outside Knob | \$45.00 |
| 87 | Tactile Warning - Abrasive Coating on Outside & Inside Knob | \$90.00 |
| BR | SARGENT Bump Resistant Cylinders (N/A w/10, 22, 30, 60, 63, 64, 70, 72, 73, 737P, KESO, SC, & SE options) | \$23.00 /cyl. |
| DG1 | Patented Degree DG1 Key System | No Addition |
| DG160 | Hardware prepared for DG1-6300 Lg. Format IC cores, supplied with temporary plastic construction cores | No addition |
| DG163 | Patented Degree DG1 Large Format Interchangeable Core Cylinder - Includes master keying charges | \$77.00 |
| DG164 | Hardware prepared for DG1-6300 Lg. Format IC cores, supplied with temporary keyed construction cores | \$77.00 |
| DG2 | Patented Degree DG2 Key System incorporating a locking sidebar | \$58.00/cyl. |
| DG260 | Hardware prepared for DG2-6300 Lg. Format IC cores, supplied with temporary plastic construction cores | No addition |
| DG263 | Patented Degree DG2 Large Format Interchangeable Core Cylinder - Includes master keying charges | \$135.00 |
| DG264 | Hardware prepared for DG2-6300 Lg. Format IC cores, supplied with temporary keyed construction cores | \$77.00 |
| DG3 | Patented Degree DG3 Key System incorporating a locking sidebar and UL437 listed | \$82.00/cyl. |
| DG360 | Hardware prepared for DG3-6300 Lg. Format IC cores, supplied with temporary plastic construction cores | No addition |
| DG363 | Patented Degree DG3 Large Format Interchangeable Core Cylinder - Includes master keying charges | \$159.00 |
| DG364 | Hardware prepared for DG3-6300 Lg. Format IC cores, supplied with temporary keyed construction cores | \$77.00 |
| LC | Less Cylinder | -\$89.00/cyl. |
| OBS | Open Back Strike | \$73.00 |
| SC▲† | Schlage "C" Keyway cylinder, (Number 41 Cylinder Only, 0 bitted) | No addition |
| SE▲† | Schlage "E" Keyway cylinder, (Number 41 Cylinder Only, 0 bitted) | No addition |
| SG | MicroShield® – an antimicrobial powder coat finish | \$67.00 |
| WBS | Wrought Box Strike | No addition |

NOTES: ▲ Options not available with a standard 50 function lockout cylinder. † Not available with 60, 63, 64 options.

| | | |
|-----|---|---------|
| CPC | 67-7904 x OB x RH x 32D x CPC (Clear Powder Coat) All orders will continue to be handled as a "special" when CPC is ordered. | \$62.00 |
|-----|---|---------|

USA & Canada Prices Effective June 3, 2019



OB

Rose: O (Shown) Knob: B (Shown)

| Function | | Finish | |
|--------------------------|------------------------------------|------------------|--|
| Single Cyl | | 10BE/26D/BSP/WSP | 03/04/09/10/10B/10BL/14/15/20D/26/32/32D |
| 67-7904 | Storeroom or Closet | | |
| 67-7937 | Classroom | \$651.00 | \$675.00 |
| 67-7955 | Office or Entry | | |
| Single Cyl With Deadbolt | | | |
| 67-7924 | Room Door | | |
| 67-7925 | Dormitory or Exit | | |
| 67-7943 | Apartment Corridor | \$664.00 | \$688.00 |
| 67-7945 | Dormitory or Exit | | |
| 67-7950 | Hotel Guest Lock | \$734.00 | \$758.00 |
| Double Cyl No Deadbolt | | | |
| 67-7916 | Apartment or Exit or Public Toilet | \$732.00 | \$756.00 |
| 67-7938 | Classroom Security Intruder | | |
| Double Cyl With Deadbolt | | | |
| 67-7926 | Store Door | \$746.00 | \$770.00 |
| Non Keyed | | | |
| 67-7915 | Passage or Closet | \$446.00 | \$470.00 |
| 67-7965 | Privacy Bedroom or Bath (Latch) | \$568.00 | \$592.00 |
| 67-7966 | Privacy Bedroom or Bath (Deadbolt) | \$601.00 | \$625.00 |
| 67-7993 | Single Dummy Trim | \$174.00 | \$186.00 |
| 67-7994 | Double Dummy Trim | \$348.00 | \$372.00 |
| 67-7995 | Single Dummy Trim w/Lockbody | \$258.00 | \$270.00 |

ML-150 MORTISE LOCKS

SARGENT®

ASSA ABLOY

OPTIONS

USA & Canada Prices Effective June 3, 2019

| Options | Description | Price |
|----------|---|---|
| 1▲ | 7900 Line with 1-1/16" wide front for 1-3/8" doors. | \$58.00 |
| 10▲ | SARGENT Signature Key System | \$58.00 / cyl. |
| 11†▲ | SARGENT XC Key System (not available with 10, 22, SC, SE options) | No addition |
| 1160 | SARGENT XC Large Format Interchangeable Plastic Disposable Construction Core | No addition |
| 1163 | SARGENT XC Large Format Interchangeable Core Cylinder - Includes masterkeying charges | \$77.00 |
| 1164 | SARGENT XC Large Format Interchangeable Construction Core Cylinder | \$77.00 |
| 1170 | Small Format interchangeable disposable construction core - to accept 7 Pin XC permanent core | No addition |
| 11727P | Small Format interchangeable keyed construction core - to accept 7 Pin XC permanent core | \$69.00 |
| 11737P | Small Format interchangeable core - to accept 7 pin XC permanent core | \$69.00 / cyl. |
| 21▲† | SARGENT Construction Key System (lost ball) Standard on all new systems established since 5/1/96 | \$16.00 / cyl. |
| 22▲† | SARGENT Construction Key System (split key) To be used on pre-established split key systems only | \$32.00 / cyl. |
| 31 | Thick Doors - Extended Lip Required - Specify Length C to E - Cylinders - IMPORTANT- See catalog 7800/8200 option page for cylinder limitations - Below charges DO NOT include additional charges for special cylinder requirements | No addition |
| | Doors up to 2-1/2" thick - lock centered | No addition |
| | Doors 2-5/8" to 6" thick OR doors 1-3/4" thick w/max 1" paneling one side. For example: Specify 1-3/4" door with panel (Side) on inside or outside | Non Keyed function \$50.00 Keyed function \$100.00 |
| 36 | 6 Lobe security head screws | \$23.00 |
| 37 | Spanner head screws | \$16.00 |
| 60 | SARGENT Large Format Interchangeable Plastic Disposable Construction Core | No addition |
| 63 | SARGENT Large Format Interchangeable core cylinder, includes master keying charges | \$77.00 / cyl. |
| 64 | SARGENT Large Format Interchangeable Construction Core Cylinder | \$77.00 |
| 6573▲† | Small Format 6-Pin Uncombined Core (Refer to CK-12) | \$59.00 / cyl. |
| 65737P▲† | Small Format 7-Pin Uncombined Core (Refer to CK-12) | \$59.00 / cyl. |
| 70▲† | Small Format Interchangeable disposable plastic construction core | No addition |
| 72▲† | Small Format Interchangeable 6-pin construction core (7-pin with 11) | \$69.00 |
| 73▲† | Small Format interchangeable core 6-pin Includes MK and GMK keying charges | \$69.00 / cyl |
| 737P▲† | Small Format interchangeable core 7-pin (refer to CK-12 for available keyways) Includes MK and GMK keying charges | \$69.00 / cyl |
| 75 | Tactile Warning - Milled Inside Knob | \$72.00 |
| 76 | Tactile Warning - Milled Outside Knob | \$72.00 |
| 77 | Tactile Warning - Milled Outside and Inside Knob | \$144.00 |
| F182▲† | SARGENT Keso Security Cylinder – patented – new key systems | \$84.00 / cyl. |
| F183▲† | SARGENT Keso Security Removable Core Cylinder – patented – new key systems | \$120.00 / cyl. |
| 81▲† | Cylinder to accept Keso (83) and Keso F1(F183) Removable Core – no core provided | No addition |
| 82▲† | SARGENT Keso Security Cylinder (For existing systems only) | \$84.00 / cyl. |
| 83▲† | SARGENT Keso Security Removable Core Cylinder (For existing systems only) | \$120.00 / cyl. |
| 84▲† | SARGENT Keso Security Removable Construction Core Cylinder | See CK-18 |
| 85 | Tactile Warning - Abrasive Coating on Inside Knob | \$45.00 |
| 86 | Tactile Warning - Abrasive Coating on Outside Knob | \$45.00 |
| 87 | Tactile Warning - Abrasive Coating on Outside & Inside Knob | \$90.00 |
| BR | SARGENT Bump Resistant Cylinders (N/A w/10, 22, 30, 60, 63, 64, 70, 72, 73, 737P, KESO, SC, & SE options) | \$23.00 /cyl. |
| DG1 | Patented Degree DG1 Key System | No Addition |
| DG160 | Hardware prepared for DG1-6300 Lg. Format IC cores, supplied with temporary plastic construction cores | No addition |
| DG163 | Patented Degree DG1 Large Format Interchangeable Core Cylinder - Includes master keying charges | \$77.00 |
| DG164 | Hardware prepared for DG1-6300 Lg. Format IC cores, supplied with temporary keyed construction cores | \$77.00 |
| DG2 | Patented Degree DG2 Key System incorporating a locking sidebar | \$58.00/cyl. |
| DG260 | Hardware prepared for DG2-6300 Lg. Format IC cores, supplied with temporary plastic construction cores | No addition |
| DG263 | Patented Degree DG2 Large Format Interchangeable Core Cylinder - Includes master keying charges | \$135.00 |
| DG264 | Hardware prepared for DG2-6300 Lg. Format IC cores, supplied with temporary keyed construction cores | \$77.00 |
| DG3 | Patented Degree DG3 Key System incorporating a locking sidebar and UL437 listed | \$82.00/cyl. |
| DG360 | Hardware prepared for DG3-6300 Lg. Format IC cores, supplied with temporary plastic construction cores | No addition |
| DG363 | Patented Degree DG3 Large Format Interchangeable Core Cylinder - Includes master keying charges | \$159.00 |
| DG364 | Hardware prepared for DG3-6300 Lg. Format IC cores, supplied with temporary keyed construction cores | \$77.00 |
| LC | Less Cylinder | -\$89.00/cyl. |
| OBS | Open Back Strike | \$73.00 |
| SC▲† | Schlage "C" Keyway cylinder, (Number 41 Cylinder Only, 0 bitted) | No addition |
| SE▲† | Schlage "E" Keyway cylinder, (Number 41 Cylinder Only, 0 bitted) | No addition |
| SG | MicroShield® – an antimicrobial powder coat finish | \$67.00 |
| WBS | Wrought Box Strike | No addition |

NOTES: ▲ Options not available with a standard 50 function lockout cylinder. † Not available with 60, 63, 64 options.

| | | |
|-----|---|---------|
| CPC | 67-7904 x KW1B x RH x 32D x CPC (Clear Powder Coat) All orders will continue to be handled as a "special" when CPC is ordered. | \$62.00 |
|-----|---|---------|

USA & Canada Prices Effective June 3, 2019



Escutcheon: KW1 (Shown) Rose: B (Shown)

| Function | | Finish | |
|---------------------------------|------------------------------------|------------------|--|
| | | 10BE/26D/BSP/WSP | 03/04/09/10/10B/10BL/14/15/20D/26/32/32D |
| Single Cyl | | | |
| 67-7904 | Storeroom or Closet | | |
| 67-7937 | Classroom | \$664.00 | \$688.00 |
| 67-7955 | Office or Entry | | |
| Single Cyl With Deadbolt | | | |
| 67-7924 | Room Door | | |
| 67-7925 | Dormitory or Exit | \$677.00 | \$701.00 |
| 67-7943 | Apartment Corridor | | |
| 67-7945 | Dormitory or Exit | | |
| 67-7950 | Hotel Guest Lock | \$751.00 | \$775.00 |
| Double Cyl No Deadbolt | | | |
| 67-7916 | Apartment or Exit or Public Toilet | \$746.00 | \$770.00 |
| 67-7938 | Classroom Security Intruder | | |
| Double Cyl With Deadbolt | | | |
| 67-7926 | Store Door | \$761.00 | \$785.00 |
| Non Keyed | | | |
| 67-7915 | Passage or Closet | \$462.00 | \$486.00 |
| 67-7965 | Privacy Bedroom or Bath (Latch) | \$586.00 | \$610.00 |
| 67-7966 | Privacy Bedroom or Bath (Deadbolt) | \$620.00 | \$644.00 |
| 67-7993 | Single Dummy Trim | \$182.00 | \$194.00 |
| 67-7994 | Double Dummy Trim | \$361.00 | \$385.00 |
| 67-7995 | Single Dummy Trim w/Lockbody | \$267.00 | \$279.00 |

ML-152 MORTISE LOCKS

SARGENT®

ASSA ABLOY

OPTIONS

USA & Canada Prices Effective June 3, 2019

| Options | Description | Price |
|----------|---|--|
| 1▲ | 7900 Line with 1-1/16" wide front for 1-3/8" doors. | \$58.00 |
| 10▲ | SARGENT Signature Key System | \$58.00 / cyl. |
| 11†▲ | SARGENT XC Key System (not available with 10, 22, SC, SE options) | No addition |
| 1160 | SARGENT XC Large Format Interchangeable Plastic Disposable Construction Core | No addition |
| 1163 | SARGENT XC Large Format Interchangeable Core Cylinder - Includes masterkeying charges | \$77.00 |
| 1164 | SARGENT XC Large Format Interchangeable Construction Core Cylinder | \$77.00 |
| 1170 | Small Format interchangeable disposable construction core - to accept 7 Pin XC permanent core | No addition |
| 11727P | Small Format interchangeable keyed construction core - to accept 7 Pin XC permanent core | \$69.00 |
| 11737P | Small Format interchangeable core - to accept 7 pin XC permanent core | \$69.00 / cyl. |
| 21▲† | SARGENT Construction Key System (lost ball) Standard on all new systems established since 5/1/96 | \$16.00 / cyl. |
| 22▲† | SARGENT Construction Key System (split key) To be used on pre-established split key systems only | \$32.00 / cyl. |
| 31 | Thick Doors - Extended Lip Required - Specify Length C to E | |
| | - Cylinders - IMPORTANT- See catalog 7800/8200 option page for cylinder limitations | |
| | - Below charges DO NOT include additional charges for special cylinder requirements | |
| | Doors up to 2-1/2" thick - lock centered | No addition |
| | Doors 2-5/8" to 6" thick OR doors 1-3/4" thick w/max 1" paneling one side. | |
| | For example: Specify 1-3/4" door with panel (Side) on inside or outside | Non Keyed function \$50.00 Keyed function \$100.00 |
| 36 | 6 Lobe security head screws | \$23.00 |
| 37 | Spanner head screws | \$16.00 |
| 60 | SARGENT Large Format Interchangeable Plastic Disposable Construction Core | No addition |
| 63 | SARGENT Large Format Interchangeable core cylinder, includes master keying charges | \$77.00 / cyl. |
| 64 | SARGENT Large Format Interchangeable Construction Core Cylinder | \$77.00 |
| 6573▲† | Small Format 6-Pin Uncombined Core (Refer to CK-12) | \$59.00 / cyl. |
| 65737P▲† | Small Format 7-Pin Uncombined Core (Refer to CK-12) | \$59.00 / cyl. |
| 70▲† | Small Format Interchangeable disposable plastic construction core | No addition |
| 72▲† | Small Format Interchangeable 6-pin construction core (7-pin with 11) | \$69.00 |
| 73▲† | Small Format interchangeable core 6-pin Includes MK and GMK keying charges | \$69.00 / cyl |
| 737P▲† | Small Format interchangeable core 7-pin (refer to CK-12 for available keyways) Includes MK and GMK keying charges | \$69.00 / cyl |
| 75 | Tactile Warning - Milled Inside Knob | \$72.00 |
| 76 | Tactile Warning - Milled Outside Knob | \$72.00 |
| 77 | Tactile Warning - Milled Outside and Inside Knob | \$144.00 |
| F182▲† | SARGENT Keso Security Cylinder – patented – new key systems | \$84.00 / cyl. |
| F183▲† | SARGENT Keso Security Removable Core Cylinder – patented – new key systems | \$120.00 / cyl. |
| 81▲† | Cylinder to accept Keso (83) and Keso F1(F183) Removable Core – no core provided | No addition |
| 82▲† | SARGENT Keso Security Cylinder (For existing systems only) | \$84.00 / cyl. |
| 83▲† | SARGENT Keso Security Removable Core Cylinder (For existing systems only) | \$120.00 / cyl. |
| 84▲† | SARGENT Keso Security Removable Construction Core Cylinder | See CK-18 |
| 85 | Tactile Warning - Abrasive Coating on Inside Knob | \$45.00 |
| 86 | Tactile Warning - Abrasive Coating on Outside Knob | \$45.00 |
| 87 | Tactile Warning - Abrasive Coating on Outside & Inside Knob | \$90.00 |
| BR | SARGENT Bump Resistant Cylinders (N/A w/10, 22, 30, 60, 63, 64, 70, 72, 73, 737P, KESO, SC, & SE options) | \$23.00 /cyl. |
| DG1 | Patented Degree DG1 Key System | No Addition |
| DG160 | Hardware prepared for DG1-6300 Lg. Format IC cores, supplied with temporary plastic construction cores | No addition |
| DG163 | Patented Degree DG1 Large Format Interchangeable Core Cylinder - Includes master keying charges | \$77.00 |
| DG164 | Hardware prepared for DG1-6300 Lg. Format IC cores, supplied with temporary keyed construction cores | \$77.00 |
| DG2 | Patented Degree DG2 Key System incorporating a locking sidebar | \$58.00/cyl. |
| DG260 | Hardware prepared for DG2-6300 Lg. Format IC cores, supplied with temporary plastic construction cores | No addition |
| DG263 | Patented Degree DG2 Large Format Interchangeable Core Cylinder - Includes master keying charges | \$135.00 |
| DG264 | Hardware prepared for DG2-6300 Lg. Format IC cores, supplied with temporary keyed construction cores | \$77.00 |
| DG3 | Patented Degree DG3 Key System incorporating a locking sidebar and UL437 listed | \$82.00/cyl. |
| DG360 | Hardware prepared for DG3-6300 Lg. Format IC cores, supplied with temporary plastic construction cores | No addition |
| DG363 | Patented Degree DG3 Large Format Interchangeable Core Cylinder - Includes master keying charges | \$159.00 |
| DG364 | Hardware prepared for DG3-6300 Lg. Format IC cores, supplied with temporary keyed construction cores | \$77.00 |
| LC | Less Cylinder | -\$89.00/cyl. |
| OBS | Open Back Strike | \$73.00 |
| SC▲† | Schlage "C" Keyway cylinder, (Number 41 Cylinder Only, 0 bitted) | No addition |
| SE▲† | Schlage "E" Keyway cylinder, (Number 41 Cylinder Only, 0 bitted) | No addition |
| SG | MicroShield® – an antimicrobial powder coat finish | \$67.00 |
| WBS | Wrought Box Strike | No addition |

NOTES: ▲ Options not available with a standard 50 function lockout cylinder. † Not available with 60, 63, 64 options.

| | | |
|-----|--|---------|
| CPC | 67-7904 x WTB x RH x 32D x CPC (Clear Powder Coat) All orders will continue to be handled as a "special" when CPC is ordered. | \$62.00 |
|-----|--|---------|

USA & Canada Prices Effective June 3, 2019



WTB

Escutcheon: WT (Shown) Rose: B (Shown)

| Function | | Finish | |
|---------------------------------|------------------------------------|------------------|--|
| | | 10BE/26D/BSP/WSP | 03/04/09/10/10B/10BL/14/15/20D/26/32/32D |
| Single Cyl | | | |
| 67-7904 | Storeroom or Closet | | |
| 67-7937 | Classroom | \$657.00 | \$681.00 |
| 67-7955 | Office or Entry | | |
| Single Cyl With Deadbolt | | | |
| 67-7924 | Room Door | | |
| 67-7925 | Dormitory or Exit | | |
| 67-7943 | Apartment Corridor | \$667.00 | \$691.00 |
| 67-7945 | Dormitory or Exit | | |
| 67-7950 | Hotel Guest Lock | \$746.00 | \$770.00 |
| Double Cyl No Deadbolt | | | |
| 67-7916 | Apartment or Exit or Public Toilet | | |
| 67-7938 | Classroom Security Intruder | \$739.00 | \$763.00 |
| Double Cyl With Deadbolt | | | |
| 67-7926 | Store Door | \$751.00 | \$775.00 |
| Non Keyed | | | |
| 67-7915 | Passage or Closet | \$453.00 | \$477.00 |
| 67-7965 | Privacy Bedroom or Bath (Latch) | \$575.00 | \$599.00 |
| 67-7966 | Privacy Bedroom or Bath (Deadbolt) | \$615.00 | \$639.00 |
| 67-7993 | Single Dummy Trim | \$176.00 | \$188.00 |
| 67-7994 | Double Dummy Trim | \$356.00 | \$380.00 |
| 67-7995 | Single Dummy Trim w/Lockbody | \$263.00 | \$275.00 |

ML-154 MORTISE LOCKS

SARGENT®

7900 LOCKBODIES

ASSA ABLOY

USA & Canada Prices Effective June 3, 2019

| 7900 Lock Bodies Only | | |
|---|------------------------------------|---------------------|
| Function | | |
| Single Cyl | Description | All Finishes |
| 04 | Storeroom or Closet | |
| 37 | Classroom | \$399.00 |
| 55 | Office or Entry | |
| Single Cyl With Deadbolt | | |
| 24 | Room Door | |
| 25 | Dormitory or Exit | |
| 43 | Apartment Corridor | \$408.00 |
| 45 | Dormitory or Exit | |
| 50 | Hotel Guest Lock | |
| Double Cyl No Deadbolt | | |
| 16 | Apartment or Exit or Public Toilet | \$399.00 |
| 38 | Classroom Security Intruder | |
| Double Cyl With Deadbolt | | |
| 26 | Store Door | \$408.00 |
| Electro Mechanical Single Cyl – Specify 12V or 24V | | |
| 70-12V / 70-24V | Fail Safe | \$680.00 |
| 71-12V / 71-24V | Fail Secure | |
| Electro Mechanical Double Cyl – Specify 12V or 24V | | |
| 72-12V / 72-24V | Fail Safe | \$680.00 |
| 73-12V / 72-24V | Fail Secure | |
| Non Keyed | | |
| 15 | Passage or Closet | \$265.00 |
| 65 | Privacy Bedroom or Bath (Latch) | \$355.00 |
| 66 | Privacy Bedroom or Bath (Deadbolt) | \$408.00 |
| 95 | Single Dummy Trim w/Lockbody | \$265.00 |

NOTE: Cylinder and trim not included. Outside front, strike and screwpack are included.

Lockbodies with options 1, 68, 69, RX, or any combination, please consult the factory for correct part number and price.

GENERAL INFORMATION 9200 HIGH SECURITY MORTISE M9200 HIGH SECURITY MORTISE

USA & Canada Prices Effective June 3, 2019

How to Order

| Step | Description | Example |
|---|--|--|
| Quantity | Each | 10 Ea. |
| Option | Consult catalog for options available | 10 Ea. 3-M- |
| Product Series | 9200 Levers | 10 Ea. 3-M-92 |
| Function | Consult catalog for functions available | 10 Ea. 3-M-9205 |
| Trim | Consult catalog for trims available | 10 Ea. 3-M-9205 SNJ |
| Finish | Consult catalog for finishes available | 10 Ea. 3-M-9205 SNJ US26D |
| Hand | Consult catalog for handing requirements | 10 Ea. 3-M-9205 SNJ US26D RH |
| Options | Consult factory for options available | 10 Ea. 3-M-9205SNJ US26D RH x 1-3/8" LIP STRIKE |
| When ordering split finishes specify outside finish first | | 10 Ea. 3-M-9205 SNJ US3 x US26D RH |

To price split trim/finish, add the price of each trim/finish and divide by two (2).

Locksets in combinations not listed should be figured by adding together the prices of the component parts.

If by any method of figuring, lower prices can be obtained than set prices shown, set prices will prevail.

It is not permissible to take full deduction for omission of a component from a lockset.

Prices are for 1 3/4" door. For other door thicknesses not listed herein, please consult factory.

ANSI Finish and Function Comparison

| Function | | | Finish | | |
|----------|---------|------------|---------|------|---------------------------|
| SARGENT | ANSI | A.S.T.M. # | SARGENT | ANSI | Description |
| 15 | F01 | 401 | US4 | 606 | Satin Brass, Clear Coated |
| 05, 55 | F04 | 404 | US26D | 626 | Satin Chrome |
| 37 | F05 | 405 | US32D | 630 | Satin Stainless Steel |
| 04 | F07 | 407 | | | |
| 16 | F09 | 409 | | | |
| 45 | F12 | | | | |
| 25 | F13 | 413MOD. | | | |
| 26 | F14 | 414-2 | | | |
| 50 | F15MOD. | | | | |
| 22 | F16 | 416 | | | |
| 21 | F17 | 417 | | | |
| 20 | F18 | 418 | | | |
| 66 | F19 | | | | |
| 24 | F21 | 421MOD. | | | |
| 43 | F20 | | | | |
| 65 | F22 | 419MOD. | | | |
| 03 | F29 | | | | |
| 17 | F30 | 433-2 | | | |
| 38 | F32 | | | | |
| 39 | F33 | | | | |
| 40 | F34 | | | | |

ML-156 MORTISE LOCKS

SARGENT®

OPTIONS-9200

ASSA ABLOY

USA & Canada Prices Effective June 3, 2019

| Options | Description | Price |
|-----------|---|--|
| 3 | Stainless Steel Hubs | \$63.00 |
| 10▲ | SARGENT Signature Key Systems | \$58.00 / cyl. |
| 11† | SARGENT XC Key System (not available with 10, 22, SC, SE options) | No addition |
| 1160 | SARGENT XC Large Format Interchangeable Plastic Disposable Construction Core | No addition |
| 1163 | SARGENT XC Large Format Interchangeable Core Cylinder - Includes masterkeying charges | \$77.00 |
| 1164 | SARGENT XC Large Format Interchangeable Construction Core Cylinder | \$77.00 |
| 1170 | Small Format interchangeable disposable construction core - to accept 7 Pin XC permanent core | No addition |
| 11727P | Small Format interchangeable keyed construction core - to accept 7 Pin XC permanent core | \$69.00 |
| 11737P | Small Format interchangeable core - to accept 7 pin XC permanent core | \$69.00 / cyl. |
| 21▲† | SARGENT Construction Key System (lost ball) Standard on all new systems established since 5/1/96 | \$16.00 / cyl. |
| 22▲† | SARGENT Construction Key System (split key) To be used on pre-established split key systems only | \$32.00 / cyl. |
| 23 | Flat Lip ANSI 4-7/8" Strike | No addition |
| 31 | Thick Doors - Extended Lip Required - Specify Length C to E - Cylinders - IMPORTANT- See catalog 7800/8200 option page for cylinder limitations - Below charges DO NOT include additional charges for special cylinder requirements | |
| | Doors up to 2-1/2" thick - lock centered | No addition |
| | Doors 2-5/8" to 6" thick OR doors 1-3/4" thick w/max 1" paneling one side. For example: Specify 1-3/4" door with panel (Side) on inside or outside | Non Keyed function \$50.00 Keyed function \$100.00 |
| 36 | 6 Lobe security head screw | \$23.00 |
| 60* | SARGENT Large Format Interchangeable Plastic Disposable Construction Core | No addition |
| 63* | SARGENT Large Format Interchangeable core cylinder, includes master keying charges | \$77.00 / cyl. |
| 64* | SARGENT Large Format Interchangeable Construction Core Cylinder | \$77.00 |
| 6573*▲† | Small Format 6-Pin Uncombined Core (Refer to CK-12) | \$59.00 / cyl. |
| 65737P*▲† | Small Format 7-Pin Uncombined Core (Refer to CK-12) | \$59.00 / cyl. |
| 68 | Lever Outside x Knob Inside – specify K or D Knob | Defaults to higher priced lock |
| 69 | Knob Outside x Lever Inside – specify K or D Knob | Defaults to higher priced lock |
| 70*▲† | Small Format Interchangeable disposable plastic construction core | No addition |
| 72*▲† | Small Format Interchangeable 6-pin construction core (7-pin with 11) | \$69.00 |
| 73*▲† | Small Format interchangeable core 6-pin Includes MK and GMK keying charges | \$69.00 / cyl. |
| 737P*▲† | Small Format interchangeable core 7-pin (refer to CK-12 for available keyways) Includes MK and GMK keying charges | \$69.00 / cyl. |
| 75 | Tactile Warning - Milled Inside Lever | \$72.00 |
| 76 | Tactile Warning - Milled Outside Lever | \$72.00 |
| 77 | Tactile Warning - Milled Outside and Inside Lever | \$144.00 |
| 81▲† | Cylinder to accept Keso (83) and Keso F1 (F183) removable core – no core provided | No addition |
| F182† | SARGENT Keso Security Cylinder – patented – new key systems | \$84.00 |
| F183▲† | SARGENT Keso Security Removable Core Cylinder – patented – new key systems | \$120.00 |
| 82† | SARGENT Keso Security Cylinder (For existing systems only) | \$84.00 |
| 83▲† | SARGENT Keso Security Removable Core Cylinder (For existing systems only) | \$120.00 |
| 84▲† | SARGENT Keso Security Removable Construction Core Cylinder | See CK-18 |
| 85 | Tactile Warning - Abrasive Coating on Inside Lever | \$45.00 |
| 86 | Tactile Warning - Abrasive Coating on Outside Lever | \$45.00 |
| 87 | Tactile Warning - Abrasive Coating on Outside & Inside Lever | \$90.00 |
| AV | Anti Vandal Pull Trim (available in 32D finish) – refer to ML-65 for Trim only (Not available with 9270, 9271, 9272, 9273 functions) | \$212.00 |
| BR | SARGENT Bump Resistant Cylinders (N/A w/10, 22, 30, 60, 63, 64, 70, 72, 73, 737P, KESO, SC, & SE options) | \$23.00 / cyl. |
| DG1 | Patented Degree DG1 Key System | No Addition |
| DG160 | Hardware prepared for DG1-6300 Lg. Format IC cores, supplied with temporary plastic construction cores | No addition |
| DG163 | Patented Degree DG1 Large Format Interchangeable Core Cylinder - Includes master keying charges | \$77.00 |
| DG164 | Hardware prepared for DG1-6300 Lg. Format IC cores, supplied with temporary keyed construction cores | \$77.00 |
| DG2 | Patented Degree DG2 Key System incorporating a locking sidebar | \$58.00/cyl. |
| DG260 | Hardware prepared for DG2-6300 Lg. Format IC cores, supplied with temporary plastic construction cores | No addition |
| DG263 | Patented Degree DG2 Large Format Interchangeable Core Cylinder - Includes master keying charges | \$135.00 |
| DG264 | Hardware prepared for DG2-6300 Lg. Format IC cores, supplied with temporary keyed construction cores | \$77.00 |
| DG3 | Patented Degree DG3 Key System incorporating a locking sidebar and UL437 listed | \$82.00/cyl. |
| DG360 | Hardware prepared for DG3-6300 Lg. Format IC cores, supplied with temporary plastic construction cores | No addition |
| DG363 | Patented Degree DG3 Large Format Interchangeable Core Cylinder - Includes master keying charges | \$159.00 |
| DG364 | Hardware prepared for DG3-6300 Lg. Format IC cores, supplied with temporary keyed construction cores | \$77.00 |
| LC | Less Cylinder | -\$89.00/cyl. |
| OBS | Open Back Strike | \$73.00 |
| M▲† | Mogul Lock - Mogul Cylinder to be ordered separate (Cylinder not included and do not receive Less Cylinder deduct | \$340.00 |
| SG | MicroShield® – an antimicrobial powder coat finish | \$67.00 |
| WBS | Wrought Box Strike | No addition |

NOTES: ▲Not available with 50 function lockout cylinder. *Does NOT meet security Grade 1 requirements.
**Not available with M- option. †Not available with 60, 63, 64 options.

| | | |
|-----|---|---------|
| CPC | Clear Powder Coat over 26D/32D – 9205 x LNB x 32D x CPC All orders will continue to be handled as a "special" when CPC is ordered. | \$62.00 |
|-----|---|---------|



LNB

Rose: LN (Shown), L • Levers: B (Shown), L, J, P

| Function | Finish | |
|--|------------|------------|
| | 04/26D | 32D |
| Single Cylinder | | |
| 9204 Storeroom | | |
| 9205 Office | | |
| 9206 Service | | |
| 9235 Storeroom | \$1,335.00 | \$1,397.00 |
| 9237 Classroom | | |
| 9255 Office | | |
| Single Cylinder with Deadbolt | | |
| 9224 Storeroom | \$1,373.00 | \$1,440.00 |
| 9225 Dormitory | | |
| Single Cylinder with Deadbolt | | |
| 9243 Entrance | \$1,397.00 | \$1,461.00 |
| 9245 Entrance | | |
| Single Cylinder with Deadbolt | | |
| * 9250 Hotel | \$1,423.00 | \$1,488.00 |
| Double Cylinder | | |
| 9216 Public Entrance | | |
| 9217 Asylum | \$1,451.00 | \$1,514.00 |
| 9238 Classroom Security | | |
| * 9259 Double Locking | | |
| Double Cylinder with Deadbolt | | |
| 9226 Storeroom | | |
| 9239 Classroom Security | | |
| 9240 Classroom Security | \$1,503.00 | \$1,568.00 |
| * 9241 Classroom Security | | |
| * 9249 Security Deadbolt | | |
| Electro Mechanical Single Cyl. – Specify 12V or 24V | | |
| * 9270-12V / 9270-24V Fail Safe | \$1,634.00 | \$1,699.00 |
| * 9271-12V / 9271-24V Fail Secure | | |
| Electro Mechanical Double Cyl. – Specify 12V or 24V | | |
| * 9272-12V / 9272-24V Fail Safe | \$1,716.00 | \$1,778.00 |
| * 9273-12V / 9273-24V Fail Secure | | |
| Keyed | | |
| * 9215 Passage | \$1,095.00 | \$1,161.00 |
| * 9265 Privacy | \$1,272.00 | \$1,337.00 |
| Non Keyed with Deadbolt | | |
| * 9266 Privacy | \$1,354.00 | \$1,419.00 |

* Not available with Mogul Cylinder (M-option)

ML-158 MORTISE LOCKS

SARGENT®

OPTIONS-9200

ASSA ABLOY

USA & Canada Prices Effective June 3, 2019

| Options | Description | Price |
|-----------|---|--|
| 3 | Stainless Steel Hubs | \$63.00 |
| 10▲ | SARGENT Signature Key Systems | \$58.00 / cyl. |
| 11**† | SARGENT XC Key System (not available with 10, 22, SC, SE options) | No addition |
| 1160 | SARGENT XC Large Format Interchangeable Plastic Disposable Construction Core | No addition |
| 1163 | SARGENT XC Large Format Interchangeable Core Cylinder - Includes masterkeying charges | \$77.00 |
| 1164 | SARGENT XC Large Format Interchangeable Construction Core Cylinder | \$77.00 |
| 1170 | Small Format interchangeable disposable construction core - to accept 7 Pin XC permanent core | No addition |
| 11727P | Small Format interchangeable keyed construction core - to accept 7 Pin XC permanent core | \$69.00 |
| 11737P | Small Format interchangeable core - to accept 7 pin XC permanent core | \$69.00 / cyl. |
| 21▲† | SARGENT Construction Key System (lost ball) Standard on all new systems established since 5/1/96 | \$16.00 / cyl. |
| 22▲† | SARGENT Construction Key System (split key) To be used on pre-established split key systems only | \$32.00 / cyl. |
| 23 | Flat Lip ANSI 4-7/8" Strike | No addition |
| 31 | Thick Doors - Extended Lip Required - Specify Length C to E - Cylinders - IMPORTANT- See catalog 7800/8200 option page for cylinder limitations - Below charges DO NOT include additional charges for special cylinder requirements | No addition |
| | Doors up to 2-1/2" thick - lock centered | No addition |
| | Doors 2-5/8" to 6" thick OR doors 1-3/4" thick w/max 1" paneling one side. For example: Specify 1-3/4" door with panel (Side) on inside or outside | Non Keyed function \$50.00 Keyed function \$100.00 |
| 36 | 6 Lobe security head screw | \$23.00 |
| 60* | SARGENT Large Format Interchangeable Plastic Disposable Construction Core | No addition |
| 63* | SARGENT Large Format Interchangeable core cylinder, includes master keying charges | \$77.00 / cyl. |
| 64* | SARGENT Large Format Interchangeable Construction Core Cylinder | \$77.00 |
| 6573*▲† | Ssmall Format 6-Pin Uncombined Core (Refer to CK-12) | \$59.00 / cyl. |
| 65737P*▲† | Small Format 7-Pin Uncombined Core (Refer to CK-12) | \$59.00 / cyl. |
| 68 | Lever Outside x Knob Inside – specify K or D Knob | Defaults to higher priced lock |
| 69 | Knob Outside x Lever Inside – specify K or D Knob | Defaults to higher priced lock |
| 70*▲† | Small Format Interchangeable disposable plastic construction core | No addition |
| 72*▲† | Small Format interchangeable 6-pin construction core (7-pin with 11) | \$69.00 |
| 73*▲† | Small Format interchangeable core 6-pin Includes MK and GMK keying charges | \$69.00 / cyl. |
| 737P*▲† | Small Format interchangeable core 7-pin (refer to CK-12 for available keyways) Includes MK and GMK keying charges | \$69.00 / cyl. |
| 75 | Tactile Warning - Milled Inside Lever | \$72.00 |
| 76 | Tactile Warning - Milled Outside Lever | \$72.00 |
| 77 | Tactile Warning - Milled Outside and Inside Lever | \$144.00 |
| 81▲† | Cylinder to accept Keso (83) and Keso F1 (F183) removable core – no core provided | No addition |
| F182† | SARGENT Keso Security Cylinder – patented – new key systems | \$84.00 |
| F183▲† | SARGENT Keso Security Removable Core Cylinder – patented – new key systems | \$120.00 |
| 82† | SARGENT Keso Security Cylinder (For existing systems only) | \$84.00 |
| 83▲† | SARGENT Keso Security Removable Core Cylinder (For existing systems only) | \$120.00 |
| 84▲† | SARGENT Keso Security Removable Construction Core Cylinder | See CK-18 |
| 85 | Tactile Warning - Abrasive Coating on Inside Lever | \$45.00 |
| 86 | Tactile Warning - Abrasive Coating on Outside Lever | \$45.00 |
| 87 | Tactile Warning - Abrasive Coating on Outside & Inside Lever | \$90.00 |
| AV | Anti Vandal Pull Trim (available in 32D finish), (Not available with 9270, 9271, 9272, 9273 functions) | \$212.00 |
| BR | SARGENT Bump Resistant Cylinders (N/A w/10, 22, 30, 60, 63, 64, 70, 72, 73, 737P, KESO, SC, & SE options) | \$23.00 /cyl. |
| DG1 | Patented Degree DG1 Key System | No Addition |
| DG160 | Hardware prepared for DG1-6300 Lg. Format IC cores, supplied with temporary plastic construction cores | No addition |
| DG163 | Patented Degree DG1 Large Format Interchangeable Core Cylinder - Includes master keying charges | \$77.00 |
| DG164 | Hardware prepared for DG1-6300 Lg. Format IC cores, supplied with temporary keyed construction cores | \$77.00 |
| DG2 | Patented Degree DG2 Key System incorporating a locking sidebar | \$58.00/cyl. |
| DG260 | Hardware prepared for DG2-6300 Lg. Format IC cores, supplied with temporary plastic construction cores | No addition |
| DG263 | Patented Degree DG2 Large Format Interchangeable Core Cylinder - Includes master keying charges | \$135.00 |
| DG264 | Hardware prepared for DG2-6300 Lg. Format IC cores, supplied with temporary keyed construction cores | \$77.00 |
| DG3 | Patented Degree DG3 Key System incorporating a locking sidebar and UL437 listed | \$82.00/cyl. |
| DG360 | Hardware prepared for DG3-6300 Lg. Format IC cores, supplied with temporary plastic construction cores | No addition |
| DG363 | Patented Degree DG3 Large Format Interchangeable Core Cylinder - Includes master keying charges | \$159.00 |
| DG364 | Hardware prepared for DG3-6300 Lg. Format IC cores, supplied with temporary keyed construction cores | \$77.00 |
| LC | Less Cylinder | -\$89.00/cyl. |
| M▲† | Mogul Lock - Mogul Cylinder to be ordered separate (Cylinder not included and do not receive Less Cylinder deduct | \$340.00 |
| OBS | Open Back Strike | \$73.00 |
| SG | MicroShield® – an antimicrobial powder coat finish | \$67.00 |
| WBS | Wrought Box Strike | No addition |

▲ Not available with 50 function lockout cylinder.

* Does NOT meet security Grade 1 requirements.

** Not available with M- option.

† Not available with 60, 63, 64 options

CPC Clear Powder Coat over 26D/32D – 9205 x SNB x 32D x CPC \$62.00
All orders will continue to be handled as a "special" when CPC is ordered.



USA & Canada Prices Effective June 3, 2019

Rose: SN, SL (Shown) • Levers: B, L (Shown), J, P

(Provided with Knurled Security Trim and Torx® Security Screws)

| Function | Finish | |
|--|------------|------------|
| | 04/26D | 32D |
| Single Cylinder | | |
| 9204 Storeroom | | |
| 9205 Office | | |
| 9206 Service | \$1,455.00 | \$1,523.00 |
| 9235 Storeroom | | |
| 9237 Classroom | | |
| 9255 Office | | |
| Single Cylinder with Deadbolt | | |
| 9224 Storeroom | \$1,500.00 | \$1,563.00 |
| 9225 Dormitory | | |
| Single Cylinder with Deadbolt | | |
| 9243 Entrance | \$1,523.00 | \$1,581.00 |
| 9245 Entrance | | |
| Single Cylinder with Deadbolt | | |
| * 9250 Hotel | \$1,544.00 | \$1,609.00 |
| Double Cylinder | | |
| 9216 Public Entrance | | |
| 9217 Asylum | \$1,577.00 | \$1,640.00 |
| 9238 Classroom Security | | |
| * 9259 Double Locking | | |
| Double Cylinder with Deadbolt | | |
| 9226 Storeroom | | |
| 9239 Classroom Security | | |
| 9240 Classroom Security | \$1,624.00 | \$1,693.00 |
| * 9241 Classroom Security | | |
| * 9249 Security Deadbolt | | |
| Electro Mechanical Single Cyl. – Specify 12V or 24V | | |
| * 9270-12V / 9270-24V Fail Safe | | |
| * 9271-12V / 9271-24V Fail Secure | \$1,756.00 | \$1,824.00 |
| Electro Mechanical Double Cyl. – Specify 12V or 24V | | |
| * 9272-12V / 9272-24V Fail Safe | | |
| * 9273-12V / 9273-24V Fail Secure | \$1,834.00 | \$1,904.00 |
| Non Keyed | | |
| * 9215 Passage | \$1,220.00 | \$1,286.00 |
| * 9265 Privacy | \$1,397.00 | \$1,461.00 |
| Keyed with Deadbolt | | |
| * 9266 Privacy | \$1,479.00 | \$1,541.00 |

* Not available with Mogul Cylinder (M-option)

ML-160 MORTISE LOCKS

SARGENT®

ASSA ABLOY

OPTIONS

USA & Canada Prices Effective June 3, 2019

| Options | Description | Price |
|-----------|--|---|
| 3 | Stainless Steel Hubs | \$63.00 |
| 10▲ | SARGENT Signature Key Systems | \$58.00 / cyl. |
| 11† | SARGENT XC Key System (not available with 10, 22, SC, SE options) | No addition |
| 1160 | SARGENT XC Large Format Interchangeable Plastic Disposable Construction Core | No addition |
| 1163 | SARGENT XC Large Format Interchangeable Core Cylinder - Includes masterkeying charges | \$77.00 |
| 1164 | SARGENT XC Large Format Interchangeable Construction Core Cylinder | \$77.00 |
| 1170 | Small Format interchangeable disposable construction core - to accept 7 Pin XC permanent core | No addition |
| 11727P | Small Format interchangeable keyed construction core - to accept 7 Pin XC permanent core | \$69.00 |
| 11737P | Small Format interchangeable core - to accept 7 pin XC permanent core | \$69.00 / cyl. |
| 21†▲ | SARGENT Construction Key System (lost ball) Standard on all new systems established since 5/1/96 | \$16.00 / cyl. |
| 22†▲ | SARGENT Construction Key System (split key) To be used on pre-established split key systems only | \$32.00 / cyl. |
| 23 | Flat Lip ANSI 4-7/8" Strike | No addition |
| 31 | Thick Doors - Extended Lip Required - Specify Length C to E - Cylinders - IMPORTANT- See catalog 7800/8200 option page for cylinder limitations - Below charges DO NOT include additional charges for special cylinder requirements Doors up to 2-1/2" thick - lock centered Doors 2-5/8" to 6" thick OR doors 1-3/4" thick w/max 1" paneling one side. For example: Specify 1-3/4" door with panel (Side) on inside or outside | No addition Non Keyed function \$50.00 Keyed function \$100.00 |
| 36 | 6 Lobe security head screw | \$23.00 |
| 60*▲ | SARGENT Large Format Interchangeable Plastic Disposable Construction Core | No addition |
| 63*▲ | SARGENT Large Format Interchangeable core cylinder, includes master keying charges | \$77.00 / cyl. |
| 64*▲ | SARGENT Large Format Interchangeable Construction Core Cylinder | \$77.00 |
| 6573*†▲ | Small Format 6-Pin Uncombined Core (Refer to CK-12) | \$59.00 / cyl. |
| 65737P*†▲ | Small Format 7-Pin Uncombined Core (Refer to CK-12) | \$59.00 / cyl. |
| 70*†▲ | Small Format interchangeable disposable plastic construction core | No addition |
| 72*†▲ | Small Format Interchangeable 6-pin construction core (7-pin with 11) | \$69.00 |
| 73*†▲ | Small Format interchangeable core 6-pin Includes MK and GMK keying charges | \$69.00 / cyl. |
| 737P*†▲ | Small Format interchangeable core 7-pin (refer to CK-12 for available keyways) Includes MK and GMK keying charges | \$69.00 / cyl. |
| 75 | Tactile Warning - Milled Inside Lever | \$72.00 |
| 76 | Tactile Warning - Milled Outside Lever | \$72.00 |
| 77 | Tactile Warning - Milled Outside and Inside Lever | \$144.00 |
| 81▲† | Cylinder to accept Keso (83) and Keso F1 (F183) removable core – no core provided | No addition |
| F182† | SARGENT Keso Security Cylinder – patented – new key systems | \$84.00 |
| F183▲† | SARGENT Keso Security Removable Core Cylinder – patented – new key systems | \$120.00 |
| 82† | SARGENT Keso Security Cylinder (For existing systems only) | \$84.00 |
| 83▲† | SARGENT Keso Security Removable Core Cylinder (For existing systems only) | \$120.00 |
| 84▲† | SARGENT Keso Security Removable Construction Core Cylinder | See CK-18 |
| 85 | Tactile Warning - Abrasive coating on inside lever | \$45.00 |
| 86 | Tactile Warning - Abrasive coating on outside lever | \$45.00 |
| 87 | Tactile Warning - Abrasive coating on both levers | \$90.00 |
| BR | SARGENT Bump Resistant Cylinders (N/A w/10, 22, 30, 60, 63, 64, 70, 72, 73, 737P, KESO, SC, & SE options) | \$23.00 / cyl. |
| DG1 | Patented Degree DG1 Key System | No Addition |
| DG160 | Hardware prepared for DG1-6300 Lg. Format IC cores, supplied with temporary plastic construction cores | No addition |
| DG163 | Patented Degree DG1 Large Format Interchangeable Core Cylinder - Includes master keying charges | \$77.00 |
| DG164 | Hardware prepared for DG1-6300 Lg. Format IC cores, supplied with temporary keyed construction cores | \$77.00 |
| DG2 | Patented Degree DG2 Key System incorporating a locking sidebar | \$58.00/cyl. |
| DG260 | Hardware prepared for DG2-6300 Lg. Format IC cores, supplied with temporary plastic construction cores | No addition |
| DG263 | Patented Degree DG2 Large Format Interchangeable Core Cylinder - Includes master keying charges | \$135.00 |
| DG264 | Hardware prepared for DG2-6300 Lg. Format IC cores, supplied with temporary keyed construction cores | \$77.00 |
| DG3 | Patented Degree DG3 Key System incorporating a locking sidebar and UL437 listed | \$82.00/cyl. |
| DG360 | Hardware prepared for DG3-6300 Lg. Format IC cores, supplied with temporary plastic construction cores | No addition |
| DG363 | Patented Degree DG3 Large Format Interchangeable Core Cylinder - Includes master keying charges | \$159.00 |
| DG364 | Hardware prepared for DG3-6300 Lg. Format IC cores, supplied with temporary keyed construction cores | \$77.00 |
| LC | Less Cylinder | -\$89.00/cyl. |
| OBS | Open Back Strike | \$73.00 |
| SG | MicroShield® – an antimicrobial powder coat finish | \$67.00 |
| WBS | Wrought Box Strike | No addition |

▲ Not available with 50 function lockout cylinder.

* Does NOT meet security Grade 1 requirements.

† Not available with 60, 63, 64 options

CPC Clear Powder Coat over 26D/32D – 9205 x LE3B x 32D x CPC \$62.00
All orders will continue to be handled as a "special" when CPC is ordered.



USA & Canada Prices Effective June 3, 2019

Escutcheon: LE3 (Shown), LE4 • Levers: B, L (Shown), J, P

| Function | | Finish | |
|--|-----------|------------|------------|
| | | 04/26D | 32D |
| Single Cylinder | | | |
| 9204 | Storeroom | | |
| 9205 | Office | | |
| 9206 | Service | \$1,472.00 | \$1,534.00 |
| 9235 | Storeroom | | |
| 9237 | Classroom | | |
| 9255 | Office | | |
| Single Cylinder with Deadbolt | | | |
| 9224 | Storeroom | \$1,514.00 | \$1,579.00 |
| 9225 | Dormitory | | |
| Single Cylinder with Deadbolt | | | |
| 9243 | Entrance | \$1,534.00 | \$1,603.00 |
| 9245 | Entrance | | |
| Single Cylinder with Deadbolt | | | |
| 9250 | Hotel | \$1,563.00 | \$1,624.00 |
| Non Keyed | | | |
| 9215 | Passage | \$1,237.00 | \$1,302.00 |
| 9265 | Privacy | \$1,411.00 | \$1,479.00 |
| Non Keyed with Deadbolt | | | |
| 9266 | Privacy | \$1,494.00 | \$1,560.00 |
| Electro Mechanical Single Cyl. – Specify 12V or 24V | | | |
| 9270-12V / 9270-24V Fail Safe | | | |
| 9271-12V / 9271-24V Fail Secure | | \$1,775.00 | \$1,834.00 |

ML-162 MORTISE LOCKS

SARGENT®

OPTIONS-9200

ASSA ABLOY

USA & Canada Prices Effective June 3, 2019

| Options | Description | Price |
|---------|---|--|
| 3 | Stainless Steel Hubs | \$63.00 |
| 10▲ | SARGENT Signature Key Systems | \$58.00 / cyl. |
| 11 | SARGENT XC Key System (not available with 10, 22, SC, SE options) | No addition |
| 21▲ | SARGENT Construction Key System (lost ball) Standard on all new systems established since 5/1/96 | \$16.00 / cyl. |
| 22▲ | SARGENT Construction Key System (split key) To be used on pre-established split key systems only | \$32.00 / cyl. |
| 23 | Flat Lip ANSI 4-7/8" Strike | No addition |
| 31 | Thick Doors - Extended Lip Required - Specify Length C to E - Cylinders - IMPORTANT- See catalog 7800/8200 option page for cylinder limitations - Below charges DO NOT include additional charges for special cylinder requirements | No addition |
| | Doors up to 2-1/2" thick - lock centered | No addition |
| | Doors 2-5/8" to 6" thick OR doors 1-3/4" thick w/max 1" paneling one side. For example: Specify 1-3/4" door with panel (Side) on inside or outside | Non Keyed function \$50.00 Keyed function \$100.00 |
| 36 | 6 Lobe security head screw | \$23.00 |
| 68 | Lever Outside x Knob Inside (K Knob Only) | Defaults to higher priced lock |
| 69 | Knob Outside x Lever Inside (K Knob Only) | Defaults to higher priced lock |
| 75 | Tactile Warning - Milled Inside Lever | \$72.00 |
| 76 | Tactile Warning - Milled Outside Lever | \$72.00 |
| 77 | Tactile Warning - Milled Outside and Inside Lever | \$144.00 |
| 85 | Tactile Warning - Abrasive coating on inside lever | \$45.00 |
| 86 | Tactile Warning - Abrasive coating on outside lever | \$45.00 |
| 87 | Tactile Warning - Abrasive coating on both levers | \$90.00 |
| BR | SARGENT Bump Resistant Cylinders (N/A w/10, 22, 30, 60, 63, 64, 70, 72, 73, 737P, KESO, SC, & SE options) | \$23.00 /cyl. |
| LC | Less Cylinder | -\$89.00/cyl. |
| OBS | Open Back Strike | \$73.00 |
| SG | MicroShield® – an antimicrobial powder coat finish | \$67.00 |
| WBS | Wrought Box Strike | No addition |

▲ Not available with 50 function lockout cylinder.

* Does NOT meet security Grade 1 requirements

CPC Clear Powder Coat over 26D/32D – 9205 x LSB x 32D x CPC \$62.00
All orders will continue to be handled as a "special" when CPC is ordered.

USA & Canada Prices Effective June 3, 2019



Escutcheon: LS (Shown) • Levers: B, L (Shown), J, P

| Function | | Finish | |
|--------------------------------------|--------------------|------------|------------|
| | | 04/26D | 32D |
| aSingle Cylinder | | | |
| 9204 | Storeroom | | |
| 9205 | Office | | |
| 9206 | Service | \$1,901.00 | \$1,966.00 |
| 9235 | Storeroom | | |
| 9237 | Classroom | | |
| 9255 | Office | | |
| Single Cylinder with Deadbolt | | | |
| 9224 | Storeroom | \$1,942.00 | \$2,005.00 |
| 9225 | Dormitory | | |
| Single Cylinder with Deadbolt | | | |
| 9243 | Entrance | \$1,966.00 | \$2,027.00 |
| 9245 | Entrance | | |
| Single Cylinder with Deadbolt | | | |
| 9250 | Hotel | \$1,990.00 | \$2,053.00 |
| Double Cylinder | | | |
| 9216 | Public Entrance | | |
| 9217 | Asylum | \$2,019.00 | \$2,082.00 |
| 9238 | Classroom Security | | |
| 9259 | Double Locking | | |
| Double Cylinder with Deadbolt | | | |
| 9226 | Storeroom | | |
| 9339 | Classroom Security | | |
| 9340 | Classroom Security | \$2,072.00 | \$2,137.00 |
| 9341 | Classroom Security | | |
| 9249 | Security Deadbolt | | |
| Non Keyed | | | |
| 9215 | Passage | \$1,665.00 | \$1,730.00 |
| 9265 | Privacy | \$1,838.00 | \$1,905.00 |
| Non Keyed with Deadbolt | | | |
| 9266 | Privacy | \$1,920.00 | \$1,985.00 |

ML-164 MORTISE LOCKS

SARGENT®

OPTIONS-9200

ASSA ABLOY

USA & Canada Prices Effective June 3, 2019

| Options | Description | Price |
|-----------|---|--|
| 3 | Stainless Steel Hubs | \$63.00 |
| 10▲ | SARGENT Signature Key Systems | \$58.00 / cyl. |
| 11**† | SARGENT XC Key System (not available with 10, 22, SC, SE options) | No addition |
| 1160 | SARGENT XC Large Format Interchangeable Plastic Disposable Construction Core | No addition |
| 1163 | SARGENT XC Large Format Interchangeable Core Cylinder - Includes masterkeying charges | \$77.00 |
| 1164 | SARGENT XC Large Format Interchangeable Construction Core Cylinder | \$77.00 |
| 1170 | Small Format interchangeable disposable construction core - to accept 7 Pin XC permanent core | No addition |
| 11727P | Small Format interchangeable keyed construction core - to accept 7 Pin XC permanent core | \$69.00 |
| 11737P | Small Format interchangeable core - to accept 7 pin XC permanent core | \$69.00 / cyl. |
| 21▲† | SARGENT Construction Key System (lost ball) Standard on all new systems established since 5/1/96 | \$16.00 / cyl. |
| 22▲† | SARGENT Construction Key System (split key) To be used on pre-established split key systems only | \$32.00 / cyl. |
| 23 | Flat Lip ANSI 4-7/8" Strike | No addition |
| 31 | Thick Doors - Extended Lip Required - Specify Length C to E - Cylinders - IMPORTANT- See catalog 7800/8200 option page for cylinder limitations - Below charges DO NOT include additional charges for special cylinder requirements | No addition |
| | Doors up to 2-1/2" thick - lock centered | No addition |
| | Doors 2-5/8" to 6" thick OR doors 1-3/4" thick w/max 1" paneling one side. | |
| | For example: Specify 1-3/4" door with panel (Side) on inside or outside | Non Keyed function \$50.00 Keyed function \$100.00 |
| 36 | SARGENT Removable Plastic Disposable Construction Core | \$23.00 |
| 60* | SARGENT Large Format Interchangeable Plastic Disposable Construction Core | No addition |
| 63* | SARGENT Large Format Interchangeable core cylinder, includes master keying charges | \$77.00 / cyl. |
| 64* | SARGENT Large Format Interchangeable Construction Core Cylinder | \$77.00 |
| 6573*▲† | Small Format 6-Pin Uncombined Core (Refer to CK-12) | \$59.00 / cyl. |
| 65737P*▲† | Small Format 7-Pin Uncombined Core (Refer to CK-12) | \$59.00 / cyl. |
| 67 | 9200 Knob Outside x Knob Inside | No Add |
| 70*▲† | Small Format Interchangeable disposable plastic construction core | No addition |
| 72*▲† | Small Format Interchangeable 6-pin construction core (7-pin with 11) | \$69.00 |
| 73*▲† | Small Format interchangeable core 6-pin Includes MK and GMK keying charges | \$69.00 / cyl. |
| 737P*▲† | Small Format interchangeable core 7-pin (refer to CK-12 for available keyways) Includes MK and GMK keying charges | \$69.00 / cyl. |
| 75 | Tactile Warning - Milled Inside Knob | \$72.00 |
| 76 | Tactile Warning - Milled Outside Knob | \$72.00 |
| 77 | Tactile Warning - Milled Outside and Inside Knob | \$144.00 |
| 81▲† | Cylinder to accept Keso (83) and Keso F1 (F183) removable core – no core provided | No addition |
| F182† | SARGENT Keso Security Cylinder – patented – new key systems | \$84.00 |
| F183▲† | SARGENT Keso Security Removable Core Cylinder – patented – new key systems | \$120.00 |
| 82† | SARGENT Keso Security Cylinder (For existing systems only) | \$84.00 |
| 83▲† | SARGENT Keso Security Removable Core Cylinder (For existing systems only) | \$120.00 |
| 84▲† | SARGENT Keso Security Removable Construction Core Cylinder | See CK-18 |
| AV | Anti Vandal Pull Trim (available in 32D finish), (Not available with 9270, 9271, 9272, 9273 functions) | \$212.00 |
| BR | SARGENT Bump Resistant Cylinders (N/A w/10, 22, 30, 60, 63, 64, 70, 72, 73, 737P, KESO, SC, & SE options) | \$23.00 / cyl. |
| DG1 | Patented Degree DG1 Key System | No Addition |
| DG160 | Hardware prepared for DG1-6300 Lg. Format IC cores, supplied with temporary plastic construction cores | No addition |
| DG163 | Patented Degree DG1 Large Format Interchangeable Core Cylinder - Includes master keying charges | \$77.00 |
| DG164 | Hardware prepared for DG1-6300 Lg. Format IC cores, supplied with temporary keyed construction cores | \$77.00 |
| DG2 | Patented Degree DG2 Key System incorporating a locking sidebar | \$58.00/cyl. |
| DG260 | Hardware prepared for DG2-6300 Lg. Format IC cores, supplied with temporary plastic construction cores | No addition |
| DG263 | Patented Degree DG2 Large Format Interchangeable Core Cylinder - Includes master keying charges | \$135.00 |
| DG264 | Hardware prepared for DG2-6300 Lg. Format IC cores, supplied with temporary keyed construction cores | \$77.00 |
| DG3 | Patented Degree DG3 Key System incorporating a locking sidebar and UL437 listed | \$82.00/cyl. |
| DG360 | Hardware prepared for DG3-6300 Lg. Format IC cores, supplied with temporary plastic construction cores | No addition |
| DG363 | Patented Degree DG3 Large Format Interchangeable Core Cylinder - Includes master keying charges | \$159.00 |
| DG364 | Hardware prepared for DG3-6300 Lg. Format IC cores, supplied with temporary keyed construction cores | \$77.00 |
| LC | Less Cylinder | -\$89.00/cyl. |
| M▲† | Mogul Lock - Mogul Cylinder to be ordered separate (Cylinder not included and do not receive Less Cylinder deduct | \$340.00 |
| OBS | Open Back Strike | \$73.00 |
| SG | MicroShield® – an antimicrobial powder coat finish | \$67.00 |
| WBS | Wrought Box Strike | No addition |

- ▲ Not available with 50 function lockout cylinder.
- * Does NOT meet security Grade 1 requirements.
- ** Not available with M- option.
- † Not available with 60, 63, 64 options

CPC Clear Powder Coat over 26D/32D – 9205 x SNB x 32D x CPC \$62.00
All orders will continue to be handled as a "special" when CPC is ordered.



SLK

USA & Canada Prices Effective June 3, 2019

Rose: SL (Shown), SN • Knob: K (Shown)

Note: Must be ordered with 67 option.

(Provided with Knurled Security Trim and Torx® Security Screws)

| Function | Finish | |
|--|------------|------------|
| | 04/26D | 32D |
| Option Single Cylinder | | |
| 67-9204 Storeroom | | |
| 67-9205 Office | | |
| 67-9206 Service | \$1,697.00 | \$1,759.00 |
| 67-9235 Storeroom | | |
| 67-9237 Classroom | | |
| 67-9255 Office | | |
| Single Cylinder with Deadbolt | | |
| 67-9224 Storeroom | \$1,737.00 | \$1,803.00 |
| 67-9225 Dormitory | | |
| Single Cylinder with Deadbolt | | |
| 67-9243 Entrance | \$1,759.00 | \$1,825.00 |
| 67-9245 Entrance | | |
| Single Cylinder with Deadbolt | | |
| * 67-9250 Hotel | \$1,783.00 | \$1,853.00 |
| Double Cylinder | | |
| 67-9216 Public Entrance | | |
| 67-9217 Asylum | \$1,814.00 | \$1,879.00 |
| 67-9238 Classroom Security | | |
| * 67-9259 Double Locking | | |
| Double Cylinder with Deadbolt | | |
| 67-9226 Storeroom | | |
| 67-9239 Classroom Security | | |
| 67-9240 Classroom Security | \$1,864.00 | \$1,930.00 |
| * 67-9241 Classroom Security | | |
| * 67-9249 Security Deadbolt | | |
| Electro Mechanical Single Cyl. – Specify 12V or 24V | | |
| * 67-9270-12V / 67-9270-24V Fail Safe | | |
| * 67-9271-12V / 67-9271-24V Fail Secure | \$1,996.00 | \$2,062.00 |
| Electro Mechanical Double Cyl. – Specify 12V or 24V | | |
| * 67-9272-12V / 67-9272-24V Fail Safe | | |
| * 67-9273-12V / 67-9273-24V Fail Secure | \$2,076.00 | \$2,142.00 |
| Non Keyed | | |
| * 67-9215 Passage | \$1,458.00 | \$1,526.00 |
| * 67-9265 Privacy | \$1,635.00 | \$1,699.00 |
| Keyed with Deadbolt | | |
| * 67-9266 Privacy | \$1,718.00 | \$1,780.00 |

* Not available with Mogul Cylinder (M-option)

ML-166 MORTISE LOCKS

SARGENT®

OPTIONS-9200

ASSA ABLOY

USA & Canada Prices Effective June 3, 2019

| Options | Description | Price |
|---------|---|--|
| 3 | Stainless Steel Hubs | \$63.00 |
| 10▲ | SARGENT Signature Key Systems | \$58.00 / cyl. |
| 11 | SARGENT XC Key System (not available with 10, 22, SC, SE options) | No addition |
| 21▲ | SARGENT Construction Key System (lost ball) Standard on all new systems established since 5/1/96 | \$16.00 / cyl. |
| 22▲ | SARGENT Construction Key System (split key) To be used on pre-established split key systems only | \$32.00 / cyl. |
| 23 | Flat Lip ANSI 4-7/8" Strike | No addition |
| 31 | Thick Doors - Extended Lip Required - Specify Length C to E - Cylinders - IMPORTANT- See catalog 7800/8200 option page for cylinder limitations - Below charges DO NOT include additional charges for special cylinder requirements | |
| | Doors up to 2-1/2" thick - lock centered | No addition |
| | Doors 2-5/8" to 6" thick OR doors 1-3/4" thick w/max 1" paneling one side. | |
| | For example: Specify 1-3/4" door with panel (Side) on inside or outside | Non Keyed function \$50.00 Keyed function \$100.00 |
| 36 | 6 Lobe security head screw | \$23.00 |
| 67 | 9200 Knob Outside x Knob Inside | No |
| Add | | |
| 75 | Tactile Warning - Milled Inside Knob | \$72.00 |
| 76 | Tactile Warning - Milled Outside Knob | \$72.00 |
| 77 | Tactile Warning - Milled Outside and Inside Knob | \$144.00 |
| BR | SARGENT Bump Resistant Cylinders (N/A w/10, 22, 30, 60, 63, 64, 70, 72, 73, 737P, KESO, SC, SE) | \$23.00 /cyl. |
| LC | Less Cylinder | -\$89.00/cyl. |
| OBS | Open Back Strike | \$73.00 |
| SG | MicroShield® – an antimicrobial powder coat finish | \$67.00 |
| WBS | Wrought Box Strike | No addition |
| ▲ | Not available with 50 function lockout cylinder. * Does NOT meet security Grade 1 requirements | |
| CPC | Clear Powder Coat over 26D/32D – 9205 x LSB x 32D x CPC All orders will continue to be handled as a "special" when CPC is ordered. | \$62.00 |



USA & Canada Prices Effective June 3, 2019

Note: Must be ordered with 67 Option

Escutcheon: LS • Knob: K

| Function | | Finish | |
|--------------------------------------|--------------------|------------|------------|
| | | 04/26D | 32D |
| Option Single Cylinder | | | |
| 67-9204 | Storeroom | | |
| 67-9205 | Office | | |
| 67-9206 | Service | | |
| 67-9235 | Storeroom | \$2,142.00 | \$2,205.00 |
| 67-9237 | Classroom | | |
| 67-9255 | Office | | |
| Single Cylinder with Deadbolt | | | |
| 67-9224 | Storeroom | \$2,185.00 | \$2,247.00 |
| 67-9225 | Dormitory | | |
| Single Cylinder with Deadbolt | | | |
| 67-9243 | Entrance | \$2,205.00 | \$2,271.00 |
| 67-9245 | Entrance | | |
| Single Cylinder with Deadbolt | | | |
| 67-9250 | Hotel | \$2,232.00 | \$2,295.00 |
| Double Cylinder | | | |
| 67-9216 | Public Entrance | | |
| 67-9217 | Asylum | \$2,261.00 | \$2,324.00 |
| 67-9238 | Classroom Security | | |
| 67-9259 | Double Locking | | |
| Double Cylinder with Deadbolt | | | |
| 67-9226 | Storeroom | | |
| 67-9339 | Classroom Security | | |
| 67-9340 | Classroom Security | \$2,310.00 | \$2,378.00 |
| 67-9341 | Classroom Security | | |
| 67-9249 | Security Deadbolt | | |
| Non Keyed | | | |
| 67-9215 | Passage | \$1,906.00 | \$1,970.00 |
| 67-9265 | Privacy | \$2,081.00 | \$2,147.00 |
| Non Keyed with Deadbolt | | | |
| 67-9266 | Privacy | \$2,162.00 | \$2,229.00 |

ML-168 MORTISE LOCKS

SARGENT®

OPTIONS-9200

ASSA ABLOY

USA & Canada Prices Effective June 3, 2019

| Options | Description | Price |
|-----------|---|--|
| 3 | Stainless Steel Hubs | \$63.00 |
| 10▲ | SARGENT Signature Key Systems | \$58.00 / cyl. |
| 11**† | SARGENT XC Key System (not available with 10, 22, SC, SE options) | No addition |
| 1160 | SARGENT XC Large Format Interchangeable Plastic Disposable Construction Core | No addition |
| 1163 | SARGENT XC Large Format Interchangeable Core Cylinder - Includes masterkeying charges | \$77.00 |
| 1164 | SARGENT XC Large Format Interchangeable Construction Core Cylinder | \$77.00 |
| 1170 | Small Format interchangeable disposable construction core - to accept 7 Pin XC permanent core | No addition |
| 11727P | Small Format interchangeable keyed construction core - to accept 7 Pin XC permanent core | \$69.00 |
| 11737P | Small Format interchangeable core - to accept 7 pin XC permanent core | \$69.00 / cyl. |
| 21▲† | SARGENT Construction Key System (lost ball) Standard on all new systems established since 5/1/96 | \$16.00 / cyl. |
| 22▲† | SARGENT Construction Key System (split key) To be used on pre-established split key systems only | \$32.00 / cyl. |
| 23 | Flat Lip ANSI 4-7/8" Strike | No addition |
| 31 | Thick Doors - Extended Lip Required - Specify Length C to E - Cylinders - IMPORTANT- See catalog 7800/8200 option page for cylinder limitations - Below charges DO NOT include additional charges for special cylinder requirements | No addition |
| | Doors up to 2-1/2" thick - lock centered | No addition |
| | Doors 2-5/8" to 6" thick OR doors 1-3/4" thick w/max 1" paneling one side. | |
| | For example: Specify 1-3/4" door with panel (Side) on inside or outside | Non Keyed function \$50.00 Keyed function \$100.00 |
| 36 | 6 Lobe security head screw | \$23.00 |
| 60* | SARGENT Large Format Interchangeable Plastic Disposable Construction Core | No addition |
| 63* | SARGENT Large Format Interchangeable core cylinder, includes master keying charges | \$77.00 / cyl. |
| 64* | SARGENT Large Format Interchangeable Construction Core Cylinder | \$77.00 |
| 6573*▲† | Small Format 6-Pin Uncombined Core (Refer to CK-12) | \$59.00 / cyl. |
| 65737P*▲† | Small Format 7-Pin Uncombined Core (Refer to CK-12) | \$59.00 / cyl. |
| 67 | 9200 Knob Outside x Knob Inside | No Add |
| 70*▲† | Small Format Interchangeable disposable plastic construction core | No addition |
| 72*▲† | Small Format Interchangeable 6-pin construction core (7-pin with 11) | \$69.00 |
| 73*▲† | Small Format interchangeable core 6-pin Includes MK and GMK keying charges | \$69.00 / cyl. |
| 737P*▲† | Small Format interchangeable core 7-pin (refer to CK-12 for available keyways) Includes MK and GMK keying charges | \$69.00 / cyl. |
| 75 | Tactile Warning - Milled Inside Knob | \$72.00 |
| 76 | Tactile Warning - Milled Outside Knob | \$72.00 |
| 77 | Tactile Warning - Milled Outside and Inside Knob | \$144.00 |
| 81▲† | Cylinder to accept Keso (83) and Keso F1 (F183) removable core – no core provided | No addition |
| F182† | SARGENT Keso Security Cylinder – patented – new key systems | \$84.00 |
| F183▲† | SARGENT Keso Security Removable Core Cylinder – patented – new key systems | \$120.00 |
| 82† | SARGENT Keso Security Cylinder (For existing systems only) | \$84.00 |
| 83▲† | SARGENT Keso Security Removable Core Cylinder (For existing systems only) | \$120.00 |
| 84▲† | SARGENT Keso Security Removable Construction Core Cylinder | See CK-18 |
| AV | Anti Vandal Pull Trim (available in 32D finish), (Not available with 9270, 9271, 9272, 9273 functions) | \$212.00 |
| DG1 | Patented Degree DG1 Key System | No Addition |
| DG160 | Hardware prepared for DG1-6300 Lg. Format IC cores, supplied with temporary plastic construction cores | No addition |
| DG163 | Patented Degree DG1 Large Format Interchangeable Core Cylinder - Includes master keying charges | \$77.00 |
| DG164 | Hardware prepared for DG1-6300 Lg. Format IC cores, supplied with temporary keyed construction cores | \$77.00 |
| DG2 | Patented Degree DG2 Key System incorporating a locking sidebar | \$58.00/cyl. |
| DG260 | Hardware prepared for DG2-6300 Lg. Format IC cores, supplied with temporary plastic construction cores | No addition |
| DG263 | Patented Degree DG2 Large Format Interchangeable Core Cylinder - Includes master keying charges | \$135.00 |
| DG264 | Hardware prepared for DG2-6300 Lg. Format IC cores, supplied with temporary keyed construction cores | \$77.00 |
| DG3 | Patented Degree DG3 Key System incorporating a locking sidebar and UL437 listed | \$82.00/cyl. |
| DG360 | Hardware prepared for DG3-6300 Lg. Format IC cores, supplied with temporary plastic construction cores | No addition |
| DG363 | Patented Degree DG3 Large Format Interchangeable Core Cylinder - Includes master keying charges | \$159.00 |
| DG364 | Hardware prepared for DG3-6300 Lg. Format IC cores, supplied with temporary keyed construction cores | \$77.00 |
| LC | Less Cylinder | -\$89.00/cyl. |
| OBS | Open Back Strike | \$73.00 |
| M▲† | Mogul Lock - Mogul Cylinder to be ordered separate (Cylinder not included and do not receive Less Cylinder deduct | \$340.00 |
| SG | MicroShield® – an antimicrobial powder coat finish | \$67.00 |
| WBS | Wrought Box Strike | No addition |

- ▲ Not available with 50 function lockout cylinder.
- * Does NOT meet security Grade 1 requirements.
- ** Not available with M- option.
- † Not available with 60, 63, 64 options

CPC Clear Powder Coat over 32D – 9205 x BHD x 32D x CPC All orders will continue to be handled as a "special" when CPC is ordered. \$62.00



SLD
Rose: SL (shown)
Knob: D (shown)

USA & Canada Prices Effective June 3, 2019

NOTE: Not ADA Compliant. Must be ordered with 67 option.

(Provided with Knurled Security Trim and Torx® Security Screws)

| Function | Finish |
|--|------------|
| Option Single Cylinder | 32D |
| 67-9204 Storeroom | |
| 67-9205 Office | |
| 67-9206 Service | \$2,459.00 |
| 67-9235 Storeroom | |
| 67-9237 Classroom | |
| 67-9255 Office | |
| Single Cylinder with Deadbolt | |
| 67-9224 Storeroom | \$2,503.00 |
| 67-9225 Dormitory | |
| Single Cylinder with Deadbolt | |
| 67-9243 Entrance | \$2,524.00 |
| 67-9245 Entrance | |
| Single Cylinder with Deadbolt | |
| * 67-9250 Hotel | \$2,549.00 |
| Double Cylinder | |
| 67-9216 Public Entrance | |
| 67-9217 Asylum | \$2,576.00 |
| 67-9238 Classroom Security | |
| * 67-9259 Double Locking | |
| Double Cylinder with Deadbolt | |
| 67-9226 Storeroom | |
| 67-9239 Classroom Security | |
| 67-9240 Classroom Security | \$2,627.00 |
| * 67-9241 Classroom Security | |
| * 67-9249 Security Deadbolt | |
| Electro Mechanical Single Cyl. – Specify 12V or 24V | |
| * 67-9270-12V / 67-9270-24V Fail Safe | |
| * 67-9271-12V / 67-9271-24V Fail Secure | \$2,759.00 |
| Electro Mechanical Double Cyl. – Specify 12V or 24V | |
| * 67-9272-12V / 67-9272-24V Fail Safe | |
| * 67-9273-12V / 67-9273-24V Fail Secure | \$2,841.00 |
| Non Keyed | |
| * 67-9215 Passage | \$2,226.00 |
| * 67-9265 Privacy | \$2,399.00 |
| Keyed with Deadbolt | |
| * 67-9266 Privacy | \$2,482.00 |

* Not available with Mogul Cylinder (M-option)

ML-170 MORTISE LOCKS

SARGENT®

9200 SERIES BEHAVIORAL HEALTH KNOB TRIM (BHD) OPTIONS

ASSA ABLOY

USA & Canada Prices Effective June 3, 2019

| Options | Description | Price |
|-----------|--|---|
| 3 | Stainless Steel Hubs | \$63.00 |
| 10▲ | SARGENT Signature Key Systems | \$58.00 / cyl. |
| 11**† | SARGENT XC Key System (not available with 10, 22, SC, SE options) | No addition |
| 1160 | SARGENT XC Large Format Interchangeable Plastic Disposable Construction Core | No addition |
| 1163 | SARGENT XC Large Format Interchangeable Core Cylinder - Includes masterkeying charges | \$77.00 |
| 1164 | SARGENT XC Large Format Interchangeable Construction Core Cylinder | \$77.00 |
| 1170 | Small Format interchangeable disposable construction core - to accept 7 Pin XC permanent core | No addition |
| 11727P | Small Format interchangeable keyed construction core - to accept 7 Pin XC permanent core | \$69.00 |
| 11737P | Small Format interchangeable core - to accept 7 pin XC permanent core | \$69.00 / cyl. |
| 21▲† | SARGENT Construction Key System (lost ball) Standard on all new systems established since 5/1/96 | \$16.00 / cyl. |
| 22▲† | SARGENT Construction Key System (split key) To be used on pre-established split key systems only | \$32.00 / cyl. |
| 23 | Flat Lip ANSI 4-7/8" Strike | No addition |
| 31 | Thick Doors - Extended Lip Required - Specify Length C to E - Cylinders - IMPORTANT- See catalog 7800/8200 option page for cylinder limitations - Below charges DO NOT include additional charges for special cylinder requirements Doors up to 2-1/2" thick - lock centered Doors 2-5/8" to 6" thick OR doors 1-3/4" thick w/max 1" paneling one side. For example: Specify 1-3/4" door with panel (Side) on inside or outside | No addition Non Keyed function \$50.00 Keyed function \$100.00 |
| 36 | 6 Lobe security head screw | \$23.00 |
| 60* | SARGENT Large Format Interchangeable Plastic Disposable Construction Core | No addition |
| 63* | SARGENT Large Format Interchangeable core cylinder, includes master keying charges | \$77.00 / cyl. |
| 64* | SARGENT Large Format Interchangeable Construction Core Cylinder | \$77.00 |
| 6573*▲† | Small Format 6-Pin Uncombined Core (Refer to CK-12) | \$59.00 / cyl. |
| 65737P*▲† | Small Format 7-Pin Uncombined Core (Refer to CK-12) | \$59.00 / cyl. |
| 67 | 9200 Knob Outside x Knob Inside | No Add |
| 70*▲† | Small Format Interchangeable disposable plastic construction core | No addition |
| 72*▲† | Small Format Interchangeable 6-pin construction core (7-pin with 11) | \$69.00 |
| 73*▲† | Small Format interchangeable core 6-pin Includes MK and GMK keying charges | \$69.00 / cyl. |
| 737P*▲† | Small Format interchangeable core 7-pin (refer to CK-12 for available keyways) Includes MK and GMK keying charges | \$69.00 / cyl. |
| 75 | Tactile Warning - Milled Inside Knob | \$72.00 |
| 76 | Tactile Warning - Milled Outside Knob | \$72.00 |
| 77 | Tactile Warning - Milled Outside and Inside Knob | \$144.00 |
| 81▲† | Cylinder to accept Keso (83) and Keso F1 (F183) removable core – no core provided | No addition |
| F182† | SARGENT Keso Security Cylinder – patented – new key systems | \$84.00 |
| F183▲† | SARGENT Keso Security Removable Core Cylinder – patented – new key systems | \$120.00 |
| 82† | SARGENT Keso Security Cylinder (For existing systems only) | \$84.00 |
| 83▲† | SARGENT Keso Security Removable Core Cylinder (For existing systems only) | \$120.00 |
| 84▲† | SARGENT Keso Security Removable Construction Core Cylinder | See CK-18 |
| AV | Anti Vandal Pull Trim (available in 32D finish), (Not available with 9270, 9271, 9272, 9273 functions) | \$212.00 |
| DG1 | Patented Degree DG1 Key System | No Addition |
| DG160 | Hardware prepared for DG1-6300 Lg. Format IC cores, supplied with temporary plastic construction cores | No addition |
| DG163 | Patented Degree DG1 Large Format Interchangeable Core Cylinder - Includes master keying charges | \$77.00 |
| DG164 | Hardware prepared for DG1-6300 Lg. Format IC cores, supplied with temporary keyed construction cores | \$77.00 |
| DG2 | Patented Degree DG2 Key System incorporating a locking sidebar | \$58.00/cyl. |
| DG260 | Hardware prepared for DG2-6300 Lg. Format IC cores, supplied with temporary plastic construction cores | No addition |
| DG263 | Patented Degree DG2 Large Format Interchangeable Core Cylinder - Includes master keying charges | \$135.00 |
| DG264 | Hardware prepared for DG2-6300 Lg. Format IC cores, supplied with temporary keyed construction cores | \$77.00 |
| DG3 | Patented Degree DG3 Key System incorporating a locking sidebar and UL437 listed | \$82.00/cyl. |
| DG360 | Hardware prepared for DG3-6300 Lg. Format IC cores, supplied with temporary plastic construction cores | No addition |
| DG363 | Patented Degree DG3 Large Format Interchangeable Core Cylinder - Includes master keying charges | \$159.00 |
| DG364 | Hardware prepared for DG3-6300 Lg. Format IC cores, supplied with temporary keyed construction cores | \$77.00 |
| LC | Less Cylinder | -\$89.00/cyl. |
| OBS | Open Back Strike | \$73.00 |
| M▲† | Mogul Lock - Mogul Cylinder to be ordered separate (Cylinder not included and do not receive Less Cylinder deduct | \$340.00 |
| SG | MicroShield® – an antimicrobial powder coat finish | \$67.00 |
| WBS | Wrought Box Strike | No addition |

- ▲ Not available with 50 function lockout cylinder.
- * Does NOT meet security Grade 1 requirements.
- ** Not available with M- option.
- † Not available with 60, 63, 64 options

CPC Clear Powder Coat over 32D – 9205 x BHD x 32D x CPC \$62.00
All orders will continue to be handled as a "special" when CPC is ordered.

9200 SERIES BEHAVIORAL HEALTH KNOB TRIM (BHD)



USA & Canada Prices Effective June 3, 2019

NOTE: Not ADA Compliant. Must be ordered with 67 option.

(Provided with Torx® Security Screws)

| Function | Finish |
|--|------------|
| Option Single Cylinder | 32D |
| 67-9204 Storeroom | |
| 67-9205 Office | |
| 67-9206 Service | \$2,459.00 |
| 67-9235 Storeroom | |
| 67-9237 Classroom | |
| 67-9255 Office | |
| Single Cylinder with Deadbolt | |
| 67-9224 Storeroom | \$2,503.00 |
| 67-9225 Dormitory | |
| Single Cylinder with Deadbolt | |
| 67-9243 Entrance | \$2,524.00 |
| 67-9245 Entrance | |
| Single Cylinder with Deadbolt | |
| * 67-9250 Hotel | \$2,549.00 |
| Double Cylinder | |
| 67-9216 Public Entrance | |
| 67-9217 Asylum | \$2,576.00 |
| 67-9238 Classroom Security | |
| * 67-9259 Double Locking | |
| Double Cylinder with Deadbolt | |
| 67-9226 Storeroom | |
| 67-9239 Classroom Security | |
| 67-9240 Classroom Security | \$2,627.00 |
| * 67-9241 Classroom Security | |
| * 67-9249 Security Deadbolt | |
| Electro Mechanical Single Cyl. – Specify 12V or 24V | |
| * 67-9270-12V / 67-9270-24V Fail Safe | \$2,759.00 |
| * 67-9271-12V / 67-9271-24V Fail Secure | |
| Electro Mechanical Double Cyl. – Specify 12V or 24V | |
| * 67-9272-12V / 67-9272-24V Fail Safe | \$2,841.00 |
| * 67-9273-12V / 67-9273-24V Fail Secure | |
| Non Keyed | |
| * 67-9215 Passage | \$2,226.00 |
| * 67-9265 Privacy | \$2,399.00 |
| Keyed with Deadbolt | |
| * 67-9266 Privacy | \$2,482.00 |

* Not available with Mogul Cylinder (M-option)

ML-172 MORTISE LOCKS

SARGENT®

9200 SERIES BEHAVIORAL HEALTH (BHW) TRIM OPTIONS

ASSA ABLOY

USA & Canada Prices Effective June 3, 2019

| Options | Description | Price |
|----------|--|--|
| 10▲ | SARGENT Signature Key System | \$58.00 / cyl. |
| 11†▲ | SARGENT XC Key System (not available with 10, 22, SC, SE options) | No addition |
| 1160 | SARGENT XC Large Format Interchangeable Plastic Disposable Construction Core | No addition |
| 1163 | SARGENT XC Large Format Interchangeable Core Cylinder - Includes masterkeying charges | \$77.00 |
| 1164 | SARGENT XC Large Format Interchangeable Construction Core Cylinder | \$77.00 |
| 1170 | Small Format interchangeable disposable construction core - to accept 7 Pin XC permanent core | No addition |
| 11727P | Small Format interchangeable keyed construction core - to accept 7 Pin XC permanent core | \$69.00 |
| 11737P | Small Format interchangeable core - to accept 7 pin XC permanent core | \$69.00 / cyl. |
| 21▲† | SARGENT Construction Key System (lost ball) Standard on all new systems established since 5/1/96 | \$16.00 / cyl. |
| 22▲† | SARGENT Construction Key System (split key) To be used on pre-established split key systems only | \$32.00 / cyl. |
| 23 | Locksets with flat 4 7/8" ANSI strike | No addition |
| 31 | Thick Doors - Extended Lip Required - Specify Length C to E – Cylinders - IMPORTANT- See 8200 Push/Pull trim catalog option page for cylinder limitations – Below charges DO NOT include additional charges for special cylinder requirements Doors up to 2-1/4" thick - lock centered – IF PANNELED – must specify panel thickness & panel location (inside or outside) For example: Specify 1-3/4" door with panel (Side) on inside or outside For doors thicker than 2-1/4" - consult factory | No addition Non Keyed function \$50.00 Keyed function \$100.00 |
| 49 | Occupancy indicator with emergency release - Available with 65, 66, & 68 functions | \$92.00 |
| 60 | SARGENT Large Format Interchangeable Plastic Disposable Construction Core | No addition |
| 63 | SARGENT Large Format Interchangeable core cylinder, includes master keying charges | \$77.00 / cyl. |
| 64 | SARGENT Large Format Interchangeable Construction Core Cylinder | \$77.00 |
| 6573▲† | Small Format 6-Pin Uncombined Core (Refer to CK-12) | \$59.00 / cyl. |
| 65737P▲† | Small Format 7-Pin Uncombined Core (Refer to CK-12) | \$59.00 / cyl. |
| 70▲† | Small Format Interchangeable disposable plastic construction core | No addition |
| 72▲† | Small Format Interchangeable 6-pin construction core (7-pin with 11 option) | \$69.00 |
| 73▲† | Small Format interchangeable core 6-pin Includes MK and GMK keying charges | \$69.00 / cyl |
| 737P▲† | Small Format interchangeable core 7-pin (refer to CK-12 for available keyways) Includes MK and GMK keying charges | \$69.00 / cyl |
| 74* | Lead Lining or Wrapping | \$272.00 |
| 81▲† | Cylinder to accept Keso (83) and Keso F1 (F183) removable core – no core provided | No Addition |
| F182† | SARGENT Keso Security Cylinder – patented – new key systems | \$84.00 / cyl. |
| F183▲† | SARGENT Keso Security Removable Core Cylinder – patented – new key systems | \$120.00 / cyl. |
| 82† | SARGENT Keso Security Cylinder (For existing systems only) | \$84.00 / cyl. |
| 83▲† | SARGENT Keso Security Removable Core Cylinder (For existing systems only) | \$120.00 / cyl. |
| 84▲† | SARGENT Keso Security Removable Construction Core Cylinder | See page CK-18 |
| BR | SARGENT Bump Resistant Cylinders (N/A w/10, 22, 30, 60, 63, 64, 70, 72, 73, 737P, KESO, SC, & SE options) | \$23.00 /cyl. |
| DG1 | Patented Degree DG1 Key System | No Addition |
| DG160 | Hardware prepared for DG1-6300 Lg. Format IC cores, supplied with temporary plastic construction cores | No addition |
| DG163 | Patented Degree DG1 Large Format Interchangeable Core Cylinder - Includes master keying charges | \$77.00 |
| DG164 | Hardware prepared for DG1-6300 Lg. Format IC cores, supplied with temporary keyed construction cores | \$77.00 |
| DG2 | Patented Degree DG2 Key System incorporating a locking sidebar | \$58.00/cyl. |
| DG260 | Hardware prepared for DG2-6300 Lg. Format IC cores, supplied with temporary plastic construction cores | No addition |
| DG263 | Patented Degree DG2 Large Format Interchangeable Core Cylinder - Includes master keying charges | \$135.00 |
| DG264 | Hardware prepared for DG2-6300 Lg. Format IC cores, supplied with temporary keyed construction cores | \$77.00 |
| DG3 | Patented Degree DG3 Key System incorporating a locking sidebar and UL437 listed | \$82.00/cyl. |
| DG360 | Hardware prepared for DG3-6300 Lg. Format IC cores, supplied with temporary plastic construction cores | No addition |
| DG363 | Patented Degree DG3 Large Format Interchangeable Core Cylinder - Includes master keying charges | \$159.00 |
| DG364 | Hardware prepared for DG3-6300 Lg. Format IC cores, supplied with temporary keyed construction cores | \$77.00 |
| LC | Less Cylinder | -\$89.00/cyl. |
| M | Mogul Lock – Mogul Cylinder to be ordered separate (See V-10 Cylinder section for Mogul Cylinder & price) | \$340.00 |
| OBS | Open Back Strike | \$73.00 |
| RX | Request to Exit | \$190.00 |
| SC▲† | Schlage "C" Keyway cylinder, (Number 41 Cylinder Only, 0 bitted) | No Addition |
| SE▲† | Schlage "E" Keyway cylinder, (Number 41 Cylinder Only, 0 bitted) | No Addition |
| SG | MicroShield® – an antimicrobial powder coat finish | \$69.00 |
| WBS | Wrought Box Strike | No Addition |

▲ Options not available with a standard 50 function lockout cylinder.

† Not available with 60, 63, 64 options

CPC Clear Powder Coat over 32/32D. All orders will continue to be handled as a "special" when CPC is ordered. \$62.00



9200 SERIES BEHAVIORAL HEALTH TRIM (BHW)

BHW

USA & Canada Prices Effective June 3, 2019

| Function | Finish |
|---|------------|
| Single Cyl | 32D |
| 9204 Storeroom or Closet | |
| *9205 Office or Entry | |
| 9237 Classroom | \$1,783.00 |
| 9255 Office or Entry | |
| Single Cyl With Deadbolt | |
| *9224 Room Door | |
| *9225 Dormitory or Exit | \$1,816.00 |
| *9235 Storeroom | |
| *9243 Apartment Corridor | |
| *9245 Dormitory or Exit | |
| *9250 Hotel Guest Lock | \$1,851.00 |
| Double Cyl No Deadbolt | |
| 9216 Apartment or Exit or Public Toilet | |
| 9217 Asylum or Institutional | \$1,872.00 |
| 9238 Classroom Security Intruder | |
| 9259 School Security | |
| Double Cyl With Deadbolt | |
| 9226 Store Door | |
| 9239, 9240 Classroom Security Intruder | \$1,912.00 |
| 9241 Classroom Security | |
| 9249 Security Deadbolt | |
| Electro Mechanical Single Cyl – Specify 12V or 24V | |
| 9270-12V/9270-24V Fail Safe | \$1,979.00 |
| 9271-12V/9271-24V Fail Secure | |
| Electro Mechanical Double Cyl – Specify 12V or 24V | |
| 9272-12V/9272-24V Fail Safe | \$2,036.00 |
| 9273-12V/9273-24V Fail Secure | |
| Non Keyed | |
| 9215 Passage or Closet | \$1,708.00 |
| *9265 Privacy Bedroom or Bath (Latch) | \$1,737.00 |
| *9266 Privacy Bedroom or Bath (D.bolt) | \$1,799.00 |

Note: Lockbodies only for BHW trim, refer to page ML-174.

* Functions not available with Mogul Cylinder (M- option).

9200 DEADLOCKS/LOCK BODIES

USA & Canada Prices Effective June 3, 2019

9200 Deadlock (No Trim)

| Function | | | Finish | |
|---------------------------------|----------------------|--------------------|----------|----------|
| Single Cylinder Deadlock | Function Description | | 04/26D | 32D |
| 9203 | Cylinder x Thumbturn | Classroom Deadlock | \$608.00 | \$675.00 |
| 9220 | Cylinder | Deadlock | \$543.00 | \$608.00 |
| 9221 | Cylinder x Thumbturn | Deadlock | \$608.00 | \$675.00 |
| Double Cylinder Deadlock | | | | |
| 9222 | Cylinder | Deadlock | \$633.00 | \$693.00 |
| 9223 | Cylinder x Thumbturn | Deadlock | \$693.00 | \$761.00 |

9200 Lockbodies (No Trim)

| Function | | | Finishes | |
|--|----------------------|------------------------------------|------------|--|
| Single Cylinder | Function Description | | 04/26D/32D | |
| Cat. # For Lever Trim: | Cat. # For Knob Trim | | | |
| 9204 | 67-9204 | Storeroom or Closet | | |
| 9205 | 67-9205 | Office or Entry | | |
| 9206 | 67-9206 | Service or Service | \$728.00 | |
| 9237 | 67-9237 | Classroom | | |
| 9255 | 67-9255 | Office or Entry | | |
| Single Cylinder with Deadbolt | | | | |
| 9224 | 67-9224 | Storeroom | | |
| 9225 | 67-9225 | Dormitory or Exit | | |
| 9235 | 67-9235 | Storeroom | \$788.00 | |
| 9243 | 67-9243 | Apartment Corridor | | |
| 9245 | 67-9245 | Dormitory or Exit | | |
| 9250 | 67-9250 | Hotel Guest | | |
| Double Cylinder | | | | |
| 9216 | 67-9216 | Apartment, Exit or Public Restroom | | |
| 9217 | 67-9217 | Asylum or Institutional | \$728.00 | |
| 9238 | 67-9238 | Classroom Security Intruder | | |
| 9259 | 67-9259 | School Security | | |
| Double Cylinder with Deadbolt | | | | |
| 9226 | 67-9226 | Store Door | | |
| 9239 | 67-9239 | Classroom Security Intruder | | |
| 9240 | 67-9240 | Classroom Security Intruder | \$788.00 | |
| 9241 | 67-9241 | Classroom Security | | |
| 9249 | 67-9249 | Security | | |
| Electro Mechanical Single Cyl. – Specify 12V or 24V | | | | |
| 9270-12V / -24V | 67-9270-12V / -24V | Electrical Fail Safe | | |
| 9271-12V / -24V | 67-9271-12V / -24V | Electrical Fail Secure | \$1,069.00 | |
| Electro Mechanical Double Cyl. – Specify 12V or 24V | | | | |
| 9272-12V / -24V | 67-9272-12V / -24V | Electrical Fail Safe | | |
| 9273-12V / -24V | 67-9273-12V / -24V | Electrical Fail Secure | \$1,069.00 | |
| Non-Keyed | | | | |
| 9215 | 67-9215 | Passage or Closet | \$509.00 | |
| 9265 | 67-9265 | Privacy Bedroom or Bath-latch | \$675.00 | |
| 9266 | 67-9266 | Privacy Bedroom or Bath-deadbolt | \$749.00 | |

Note: Cylinder and trim not included with lockbodies. Outside front, strike and screwpack are included.

Lockbodies with options 3, 68, 69, or M or any combination, please consult factory for correct part # and price.

USA & Canada Prices Effective June 3, 2019

| 9200 Trim - Specify finish when ordering | | | Price | |
|---|--|---|-----------------------|----------|
| Part # | Design | Description | 04/26D | 32D |
| | B, J, L, P | Levers - Same as 8200 - refer to 8200 Lever Section | refer to 8200 section | |
| | LE3, LE4, LS | Escutcheons - Same as 8200 - refer to 8200 Inside and Outside Escutcheon Section. | refer to 8200 section | |
| | LN, L | Rose - Same as 8200 - refer to 8200 Rose Section | refer to 8200 section | |
| 92-0034 | SN | Rose - Security Trim ONLY - requires 92-2171 Trim Pack | \$45.62 | \$50.89 |
| 92-0064 | SL | Rose - Security Trim ONLY - requires 92-2173 Trim Pack | \$45.62 | \$50.89 |
| 92-0091 | BH | Rose | \$40 (32) | \$38.00 |
| 92-2142 | | Detention Knob for M9200 - O/S Assy. (Cone Shaped) | \$448.99 | \$464.45 |
| 9200 Accessories - Specify finish when ordering | | | Price | |
| Part # | Description | | 04/26D | 32D |
| 184SKB | Outside Emergency Release Assembly (with Torx screws) | | \$49.00 | \$60.00 |
| 130SKB | Thumbturn Lever Assembly (Torx screws only) | | \$49.00 | \$60.00 |
| 130SB | Knurled Knob Assembly (with Torx screws) | | \$168.00 | \$173.00 |
| 9200 Miscellaneous Parts | | | Price | |
| Part # | Description | | Price | |
| *M92 | Blocking Ring | | \$86.00 | |
| 01-4402 | Lockbody Case/Cap Machine Screw - #8-32 x 5/16" (5 per lockbody) | | \$0.49 | |
| *92 | Blocking Ring | | \$52.00 | |
| *92-0015 | O/S Front (15, 65) | | \$45.44 | |
| *92-0016 | O/S Front (04, 06, 13, 16, 17, 31, 36, 37, 38, 67, 70, 71, 72, 73, 78, 79) | | \$45.44 | |
| *92-0017 | O/S Front (03, 20, 21, 22, 23) | | \$45.44 | |
| *92-0018 | O/S Front (24, 25, 26) | | \$45.44 | |
| *92-0019 | O/S Front (40, 41, 50, 51, 52, 76, 77) | | \$45.44 | |
| *92-0020 | O/S Front (05) | | \$45.44 | |
| *92-0021 | O/S Front (45) | | \$45.44 | |
| *92-0022 | O/S Front (43) | | \$45.44 | |
| 92-0066 | Mogul Cylinder Camp Spring | | \$3.05 | |
| *92-0072 | M- O/S Front (04, 16, 17, 17, 37) | | \$45.44 | |
| *92-0073 | M- O/S Front (03, 20, 21, 22, 23) | | \$45.44 | |
| *92-0074 | M- O/S Front (24, 25, 26) | | \$45.44 | |
| *92-0075 | M- O/S Front (40, 41, 50, 51, 52, 76, 77) | | \$45.44 | |
| *92-0076 | M- O/S Front (05) | | \$45.44 | |
| *92-0077 | M- O/S Front (45) | | \$45.44 | |
| *92-0078 | M- O/S Front (43) | | \$45.44 | |
| *92-0079 | O/S Front (70, 71, 72, 73) | | \$45.44 | |
| *92-0080 | M- O/S Front (70, 71, 72, 73) | | \$45.44 | |
| 92-2151 | SN Adaptor & Plate Assembly | | \$10.40 | |
| 92-2152 | SL Adaptor & Plate Assembly | | \$12.53 | |
| 92-2171 | Trim Pack (SN) | | \$66.35 | |
| 92-2173 | Trim Pack (SL) | | \$66.35 | |
| *1AB-1 | Tapered Cyl. Rosette | | \$109.00 | |
| *1MB-1 | Tapered Cyl. Rosette | | \$97.00 | |
| *1SB-1 | Cylinder Ring Rosette | | \$54.00 | |

Note: Must consult factory for parts relating to M9200's.

* Specify finish when ordering – 4, 26D, 32D.

ML-176 MORTISE LOCKS

SARGENT®

9200 INSIDE TRIM SET

ASSA ABLOY

USA & Canada Prices Effective June 3, 2019

| Lock Function | | | | | Rose | Lever | 04/26D | 32D |
|---------------|---------|---------|---------|---------|-----------------|--------------------------|----------------------|----------------------|
| IS-9204 | IS-9235 | IS-9245 | | | L, LN SN, SL | B, J, L, P B, J, L, P | \$401.00 \$438.00 | \$434.00 \$470.00 |
| IS-9205 | IS-9237 | IS-9270 | | | | | | |
| IS-9206 | IS-9255 | IS-9271 | | | | | | |
| IS-9215 | IS-9243 | | | | | | | |
| IS-9216 | IS-9259 | IS-9249 | | | L, LN SN, SL | B, J, L, P B, J, L, P | \$411.00 \$446.00 | \$440.00 \$476.00 |
| IS-9217 | IS-9239 | IS-9272 | | | | | | |
| IS-9226 | IS-9240 | IS-9273 | | | | | | |
| IS-9238 | IS-9241 | | | | | | | |
| IS-9224 | IS-9250 | IS-9266 | | | L, LN SN, SL | B, J, L, P B, J, L, P | \$439.00 \$475.00 | \$472.00 \$509.00 |
| IS-9225 | IS-9265 | | | | | | | |
| Lock Function | | | | | Escutcheon | Lever | 04/26D | 32D |
| IS-9204 | IS-9237 | IS-9255 | IS-9271 | | LE3 | B, J, L, P | \$441.00 | \$475.00 |
| IS-9205 | IS-9215 | | IS-9270 | | | | | |
| IS-9243 | IS-9224 | IS-9250 | IS-9266 | | LE3 | B, J, L, P | \$473.00 | \$504.00 |
| IS-9245 | IS-9225 | | IS-9265 | | | | | |
| Lock Function | | | | | Escutcheon | Lever | 04/26D | 32D |
| IS-9204 | IS-9206 | IS-9235 | IS-9243 | IS-9255 | LS | B, J, L, P | \$572.00 | \$606.00 |
| IS-9205 | IS-9215 | | IS-9237 | | | | | |
| IS-9216 | IS-9226 | IS-9239 | IS-9241 | IS-9259 | LS | B, J, L, P | \$576.00 | \$610.00 |
| IS-9217 | IS-9238 | IS-9240 | IS-9249 | | | | | |
| IS-9224 | IS-9250 | IS-9266 | | | LS | B, J, L, P | \$609.00 | \$642.00 |
| IS-9225 | IS-9265 | | | | | | | |
| Lock Function | | | | | Rose | Knob | 04/26D | 32D |
| IS-9204 | IS-9235 | IS-9255 | | | SL, SN | K | \$511.00 | \$542.00 |
| IS-9205 | IS-9237 | IS-9270 | | | | | | |
| IS-9206 | IS-9243 | IS-9271 | | | | | | |
| IS-9215 | IS-9245 | | | | | | | |
| IS-9216 | IS-9259 | IS-9249 | | | SL, SN | K | \$517.00 | \$550.00 |
| IS-9217 | IS-9239 | IS-9272 | | | | | | |
| IS-9226 | IS-9240 | IS-9273 | | | | | | |
| IS-9238 | IS-9241 | | | | | | | |
| IS-9224 | IS-9250 | IS-9266 | | | SL, SN | K | \$541.00 | \$573.00 |
| IS-9225 | IS-9265 | | | | | | | |
| Lock Function | | | | | Rose | Knob | 32D | 32 |
| IS-9204 | IS-9235 | IS-9255 | | | SL | D | \$737.00 | \$770.00 |
| IS-9205 | IS-9237 | IS-9270 | | | | | | |
| IS-9206 | IS-9243 | IS-9271 | | | | | | |
| IS-9215 | IS-9245 | | | | | | | |
| IS-9216 | IS-9259 | IS-9249 | | | SL | D | \$745.00 | \$778.00 |
| IS-9217 | IS-9239 | IS-9272 | | | | | | |
| IS-9226 | IS-9240 | IS-9273 | | | | | | |
| IS-9238 | IS-9241 | | | | | | | |
| IS-9224 | IS-9250 | IS-9266 | | | SL | D | \$768.00 | \$802.00 |
| IS-9225 | IS-9265 | | | | | | | |
| Lock Function | | | | | Rose | Knob | 32D | 32 |
| IS-9204 | IS-9235 | IS-9255 | | | BH | D | \$737.00 | \$770.00 |
| IS-9205 | IS-9237 | IS-9270 | | | | | | |
| IS-9206 | IS-9243 | IS-9271 | | | | | | |
| IS-9215 | IS-9245 | | | | | | | |
| IS-9216 | IS-9259 | IS-9249 | | | BH | D | \$745.00 | \$778.00 |
| IS-9217 | IS-9239 | IS-9272 | | | | | | |
| IS-9226 | IS-9240 | IS-9273 | | | | | | |
| IS-9238 | IS-9241 | | | | | | | |
| IS-9224 | IS-9250 | IS-9266 | | | BH | D | \$768.00 | \$802.00 |
| IS-9225 | IS-9265 | | | | | | | |
| Lock Function | | | | | Escutcheon | Knob | 04/26D | 32D |
| IS-9204 | IS-9235 | IS-9255 | | | LS | K | \$647.00 | \$679.00 |
| IS-9205 | IS-9237 | IS-9270 | | | | | | |
| IS-9206 | IS-9243 | IS-9271 | | | | | | |
| IS-9215 | IS-9245 | | | | | | | |
| IS-9216 | IS-9259 | IS-9249 | | | LS | K | \$652.00 | \$683.00 |
| IS-9217 | IS-9239 | IS-9272 | | | | | | |
| IS-9226 | IS-9240 | IS-9273 | | | | | | |
| IS-9238 | IS-9241 | | | | | | | |
| IS-9224 | IS-9250 | IS-9266 | | | LS | K | \$675.91 | \$707.00 |
| IS-9225 | IS-9265 | | | | | | | |

USA & Canada Prices Effective June 3, 2019

| Lock Function | Rose | Lever | 04/26D | 32D |
|---|-----------------|--------------------------|----------------------|----------------------|
| OS-9204 OS-9224 OS-9239 OS-9249 OS-9271 OS-9205 OS-9225 OS-9240 OS-9250 OS-9272 OS-9206 OS-9226 OS-9241 OS-9255 OS-9273 OS-9216 OS-9237 OS-9243 OS-9259 OS-9217 OS-9238 OS-9245 OS-9270 | L, LN SN, SL | B, J, L, P B, J, L, P | \$427.00 \$465.00 | \$461.00 \$500.00 |
| OS-9215 | L, LN SN, SL | B, J, L, P B, J, L, P | \$418.00 \$459.00 | \$453.00 \$489.00 |
| OS-9265 OS-9266 | L, LN SN, SL | B, J, L, P B, J, L, P | \$441.00 \$480.00 | \$475.00 \$515.00 |
| Lock Function | Escutcheon | Lever | 04/26D | 32D |
| OS-9204 OS-9224 OS-9250 OS-9245 OS-9205 OS-9225 OS-9255 OS-9270 OS-9206 OS-9237 OS-9243 OS-9271 | LE3 & LE4 | B, J, L, P | \$473.00 | \$504.00 |
| OS-9215 | LE3 & LE4 | B, J, L, P | \$465.00 | \$500.00 |
| OS-9265 OS-9266 | LE3 & LE4 | B, J, L, P | \$488.00 | \$520.00 |
| Lock Function | Escutcheon | Lever | 04/26D | 32D |
| OS-9204 OS-9217 OS-9237 OS-9241 OS-9250 OS-9205 OS-9224 OS-9238 OS-9243 OS-9255 OS-9206 OS-9225 OS-9239 OS-9245 OS-9259 OS-9216 OS-9226 OS-9240 OS-9249 | LS | B, J, L, P | \$609.00 | \$642.00 |
| OS-9215 | LS | B, J, L, P | \$604.00 | \$634.00 |
| OS-9265 OS-9266 | LS | B, J, L, P | \$624.00 | \$656.00 |
| Lock Function | Rose | Knob | 04/26D | 32D |
| OS-9204 OS-9224 OS-9239 OS-9249 OS-9271 OS-9205 OS-9225 OS-9240 OS-9250 OS-9272 OS-9206 OS-9226 OS-9241 OS-9255 OS-9273 OS-9216 OS-9237 OS-9243 OS-9259 OS-9217 OS-9238 OS-9245 OS-9270 | SN, SL | K | \$542.00 | \$574.00 |
| OS-9215 | SN, SL | K | \$536.00 | \$569.00 |
| OS-9265 OS-9266 | SN, SL | K | \$557.00 | \$592.00 |
| Lock Function | Escutcheon | Knob | 32D | 32 |
| OS-9204 OS-9224 OS-9239 OS-9249 OS-9271 OS-9205 OS-9225 OS-9240 OS-9250 OS-9272 OS-9206 OS-9226 OS-9241 OS-9255 OS-9273 OS-9216 OS-9237 OS-9243 OS-9259 OS-9217 OS-9238 OS-9245 OS-9270 | SL | D | \$787.00 | \$820.00 |
| OS-9215 | SL | D | \$780.00 | \$812.00 |
| OS-9265 OS-9266 | SL | D | \$803.00 | \$837.00 |
| Lock Function | Escutcheon | Knob | 04/26D | 32D |
| OS-9204 OS-9224 OS-9239 OS-9249 OS-9271 OS-9205 OS-9225 OS-9240 OS-9250 OS-9272 OS-9206 OS-9226 OS-9241 OS-9255 OS-9273 OS-9216 OS-9237 OS-9243 OS-9259 OS-9217 OS-9238 OS-9245 OS-9270 | LS | K | \$686.00 | \$719.00 |
| OS-9215 | LS | K | \$680.00 | \$713.00 |
| OS-9265 OS-9266 | LS | K | \$704.00 | \$735.00 |

MULTI-POINT LOCKING HARDWARE

How to Order - ANSI Finish & Function Comparison MP-1

7000 Series

Options MP-2

7000 Series Vertical Rod Lock..... MP-3

AD7000 Series

Options MP-4

AD7000 Series Vertical Rod Lock..... MP-5

WD7000 Series

Options MP-6

WD7000 Series Vertical Rod Lock..... MP-7

ER/ES/ET Lever Control Trim

ER/ES/ET Standard, Coastal and Studio Collection
(Except Gramercy Series) Lever Control Trim..... MP-8

ER/ES/ET Gramercy Series Lever Control Trim..... MP-9

7000 Rod Replacement Kits, Locking Slide..... MP-10

Parts MP-11

FM6100 Series

Options MP-12

FM6100 Series Multi-Point Auto Deadlocking
Storm Shutter System MP-13

FM7300 Series

Options MP-14

FM7300 Series Multi-Point Lock MP-15

Options MP-16

FM7300 Series Multi-Point Lock MP-17

Options MP-18

FM7300 Series Multi-Point Lock MP-19

Options MP-20

FM7300 Series Multi-Point Lock MP-21

Options MP-22

FM7300 Series Freewheeling Multi-Point Lock MP-23

How To Order

| Step | Description | Example |
|------------------|--|---|
| Quantity | Each | 10 Ea. |
| Option | Consult proper section for options available | 10 Ea. 12- |
| Series | 70, AD70, or WD70 | 10 Ea. 12-70 |
| Outside Function | Consult proper section for functions available | 10 Ea. 12-7006 |
| Inside Function | Consult proper section for functions available | 10 Ea. 12-700613 |
| Trim | Consult proper section for trims available | 10 Ea. 12-700613 ETL |
| Hand | Consult proper section for handing required | 10 Ea. 12-700613 ETL LHRB |
| Finish | Consult proper section for finishes available | 10 Ea. 12-700613 ETL LHRB 26 |
| Door Height | Specify Height of Door | 10 Ea. 12-700613 ETL LHRB 26 96" |

ANSI Finish and Function Comparison

| Function | | Finish | | |
|----------|---------------|---------|------|---|
| SARGENT | ANSI | SARGENT | ANSI | Description |
| 10-DT | 02 | US3 | 605 | Polished Brass |
| 13 | 08 | US4 | 606 | Satin Brass |
| 15 | 14 | US9 | 611 | Polished Bronze |
| 06 | 09 | US10 | 612 | Satin Bronze |
| 16 | 10 | US10B | 613 | Oxidized Satin Bronze/Oil Rubbed |
| 40 | Similar to 02 | US10BE | 613E | Dark Oxidized Satin Bronze - Equivalent |
| 43 | Similar to 08 | US10BL | — | Oxidized Satin Bronze/Lacquered |
| 46 | Similar to 09 | US14 | 618 | Bright nickel, clear coated |
| | | US15 | 619 | Satin nickel, clear coated |
| | | US20D | — | Dark Statuary Bronze Powder Coated |
| | | US26 | 625 | Polished Chrome |
| | | US26D | 626 | Satin Chrome |
| | | BSP | — | Black Suede Powder Coat |
| | | WSP | — | White Suede Powder Coat |

MP-2 MULTI-POINT LOCKING HARDWARE

SARGENT®

7000 SERIES OPTIONS

ASSA ABLOY

USA & Canada Prices Effective June 3, 2019

| Options | Description | Price |
|---------|--|-----------------|
| 10 | SARGENT Signature System | \$58.00 / cyl. |
| 11 | SARGENT XC Key System (not available with 10, 22, SC, SE options) | No addition |
| 1160 | Sargent XC Large Format Interchangeable Plastic Disposable Construction Core | No addition |
| 1163 | Sargent XC Large Format Interchangeable Core Cylinder - Includes masterkeying charges | \$77.00 |
| 1164 | Sargent XC Large Format Interchangeable Construction Core Cylinder | \$77.00 |
| 1170 | Small Format interchangeable disposable construction core - to accept 7 Pin XC permanent core | No addition |
| 11727P | Small Format interchangeable keyed construction core - to accept 7 Pin XC permanent core | \$69.00 |
| 11737P | Small Format interchangeable core - to accept 7 pin XC permanent core | \$69.00 |
| 12 | UL Fire Label Exit Devices (Not available on single door applications) | \$177.00 |
| 21 | SARGENT Construction Key System (lost ball) | \$16.00 /cyl. |
| 22 | SARGENT Construction Key System (split key) | \$32.00 /cyl. |
| 31 | For doors up to 2-1/4" | No addition |
| | For doors over 2-1/4" | Consult Factory |
| | For doors over 2-1/4" or doors with panels | Consult Factory |
| 36 | 6 Lobe security head screws | \$60.00 |
| 37 | Spanner head screws | \$42.00 |
| 53 | Top bolt monitoring switch | \$237.00 |
| 54 | Monitor outside lever | \$214.00 |
| 55 | Monitor inside lever | \$223.00 |
| 60 | SARGENT Large Format Interchangeable Plastic Disposable Construction Core | No addition |
| 63 | SARGENT Large Format Interchangeable Core Cylinder includes master and grandmaster keying charge | \$77.00 /cyl. |
| 64 | SARGENT Large Format Interchangeable Construction Core Cylinder | \$77.00 |
| 6573 | Small Format 6 Pin Uncombined Core | \$59.00 / cyl. |
| 65737P | Small Format 7 Pin Uncombined Core | \$59.00 / cyl. |
| 70 | Small Format Interchangeable Disposable plastic Construction Core | No addition |
| 72 | Small Format Interchangeable 6-Pin Construction Core (7-pin with 11 option) | \$69.00 |
| 73 | Small Format interchangeable core 6-pin Includes MK and GMK keying charges (Not available with J lever) | \$69.00 |
| 737P | Small Format interchangeable core 7-pin (refer to CK-12 for available keyways) | |
| | Includes MK and GMK keying charges (Not available with J lever) | \$69.00 |
| 75 | Tactile Warning - Milled on backside of inside lever (Not available with Studio & Coastal Levers and the A Lever) | \$72.00 |
| 76 | Tactile Warning - Milled on backside of outside lever (Not available with Studio & Coastal Levers and the A Lever) | \$72.00 |
| 77 | Tactile Warning - Milled on backside of both levers (Not available with Studio & Coastal Levers and the A Lever) | \$144.00 |
| F182 | SARGENT Keso Security, patent pending, cylinder - new key systems | \$84.00 / cyl. |
| F183 | SARGENT Keso Security, patent pending, removable core cylinder - new key systems | \$120.00 / cyl. |
| 81 | Cylinder to accept Keso (83) and Keso F1 (F183) Removable Core - no core provided | No addition |
| 82 | SARGENT Keso Security Cylinder (existing key systems only) | \$84.00 / cyl. |
| 83 | SARGENT Keso Security Removable Core Cylinder (existing key systems only) | \$120.00 / cyl. |
| 84 | SARGENT Keso Security Removable Construction Core Cylinder | See CK-18 |
| 85 | Tactile Warning - Abrasive coating on inside lever | \$45.00 |
| 86 | Tactile Warning - Abrasive coating on outside lever | \$45.00 |
| 87 | Tactile Warning - Abrasive coating on both levers | \$90.00 |
| 88 | Lever holdback | \$21.00 |
| BR | SARGENT Bump Resistant Cyls. (N/A w/10, 22, 30, 60, 63, 64, 70, 72, 73, 737P, KESO, SC, SE) | \$23.00 /cyl. |
| CPC | Clear Powder Coat over 26D. All orders will continue to be handled as a "special" when CPC is ordered. | \$62.00 |
| DG1 | Patented Degree DG1 Key System | No Addition |
| DG160 | Hardware prepared for DG1-6300 Lg. Format IC cores, supplied with temporary plastic construction cores | No addition |
| DG163 | Patented Degree DG1 Large Format Interchangeable Core Cylinder - Includes master keying charges | \$77.00 |
| DG164 | Hardware prepared for DG1-6300 Lg. Format IC cores, supplied with temporary keyed construction cores | \$77.00 |
| DG2 | Patented Degree DG2 Key System incorporating a locking sidebar | \$58.00/cyl. |
| DG260 | Hardware prepared for DG2-6300 Lg. Format IC cores, supplied with temporary plastic construction cores | No addition |
| DG263 | Patented Degree DG2 Large Format Interchangeable Core Cylinder - Includes master keying charges | \$135.00 |
| DG264 | Hardware prepared for DG2-6300 Lg. Format IC cores, supplied with temporary keyed construction cores | \$77.00 |
| DG3 | Patented Degree DG3 Key System incorporating a locking sidebar and UL437 listed | \$82.00/cyl. |
| DG360 | Hardware prepared for DG3-6300 Lg. Format IC cores, supplied with temporary plastic construction cores | No addition |
| DG363 | Patented Degree DG3 Large Format Interchangeable Core Cylinder - Includes master keying charges | \$159.00 |
| DG364 | Hardware prepared for DG3-6300 Lg. Format IC cores, supplied with temporary keyed construction cores | \$77.00 |
| ELR | Electric Latch Retraction | \$835.00 |
| HC | Hurricane Code | \$120.00 |
| NB | No Bottom | No Addition |
| LC | Less Cylinder | -\$89.00/cyl. |
| SC | Schlage C Keyway Cylinder 0-Bitted (Rim and #41 Mortise Cylinder Only) | No addition |
| SE | Schlage E Keyway Cylinder 0-Bitted (Rim and #41 Mortise Cylinder Only) | No addition |
| SG | MicroShield® an antimicrobial powder coat (not available with 10B) | \$82.00 |
| WS | Windstorm Certified | No Addition |
| | Concealed/Surface Vertical Rod Device - Over 96" to 120" Height | \$60.00 |



Six Digit Function #:
 Series **70**
 Outside function **7001**
 Inside function **700106**

Please specify hand when ordering.

| 7000 Series-Vertical Rod Lock | |
|--|--|
| ER/ES/ET Control Standard Levers: A-B-E-F-J-L-P-W Coastal Levers: G-R-S-Y All Studio Collection Levers (Except Gramercy, Wooster Square, & Grant Park) | ER/ES/ET Control Gramercy Levers: RAG-RAL-RAM-RAS-RCM-REM-RGM Wooster Square Levers: H001-H002-H003-H004-H005-H006 Grant Park Levers: H007-H008-H009-H010-H011 |
| Finishes listed below are for ET trim on both sides. Refer to catalog for available trims, trim finishes and how to order. | |

| 7000 Series Function | Description | 10BE/26D/BSP/WSP | 03/04/09/10/10B/10BL/14/15/20D/26 | Gramercy:10BE/BSP/WSP/629/630 Wstr Sq/Grant Park: 10BE/26D/BSP/WSP | 03/04/09/10/10B/10BL/14/15/20D/26 |
|---|--|------------------|-----------------------------------|--|-----------------------------------|
| 700106 | Blank plate x key operates ET | | | | |
| 700113 | Blank plate x key lock/unlocks control | | | | |
| 700115 | Blank plate x trim always operable | | | | |
| 700143 | Blank plate x free wheeling key engages/disengages lever | | | | |
| 700146 | Blank plate x free wheeling key operates ET | | | | |
| 700606 | Key operates ET both sides | | | | |
| 700613 | Key operates ET x key lock/unlocks control | | | | |
| 700615 | Key operates ET x trim always operable | | | | |
| 701006 | Dummy trim x key operates ET | | | | |
| 701013 | Dummy trim x key lock/unlocks control | \$2,085.00 | \$2,162.00 | \$2,274.00 | \$2,348.00 |
| 701015 | Dummy trim (lever rigid) x trim always operable | | | | |
| 701306 | Key lock/unlock control x key operates ET | | | | |
| 701313 | Key lock/unlocks control both sides | | | | |
| 701315 | Key locks/unlocks control x trim always operable | | | | |
| 701506 | Trim always operable x key operates ET | | | | |
| 701513 | Trim always operable x key lock/unlocks control | | | | |
| 701515 | Trim always operable both sides | | | | |
| 701543 | Trim always operable x fw key engages/disengages lever | | | | |
| 701546 | Trim always operable x fw key operates ET | | | | |
| 701616 | Classroom both sides | | | | |
| 7000 Series With Freewheeling Trim | | | | | |
| 704043 | Dummy trim x key engages/disengages lever | | | | |
| 704046 | Dummy trim x key operates ET | | | | |
| 704315 | Key engages/disengages Lever | | | | |
| 704340 | Key engages/disengages lever x dummy trim | | | | |
| 704343 | Key engages/disengages lever both sides | \$2,085.00 | \$2,162.00 | \$2,274.00 | \$2,348.00 |
| 704346 | Key engages/disengages lever x key operates ET | | | | |
| 704615 | Key operates ET x trim always operable | | | | |
| 704640 | Key operates ET x dummy trim | | | | |
| 704643 | Key operates ET x key engages/disengages lever | | | | |
| 704646 | Key operates ET on both sides | | | | |
| Electromechanical | | | | | |
| *700173 | Blank plate x fail safe | | | | |
| *700174 | Blank plate x fail secure | | | | |
| *700673 | Key operates ET x fail safe | | | | |
| *700674 | Key operates ET x fail secure | | | | |
| *701073 | Dummy trim x fail safe | | | | |
| *701074 | Dummy trim x fail secure | | | | |
| *707306 | Fail safe x key operates ET | \$2,259.00 | \$2,335.00 | \$2,449.00 | \$2,523.00 |
| *707313 | Fail safe x key locks/unlocks control | | | | |
| *707315 | Fail safe x trim always operable | | | | |
| *707406 | Fail secure x key operates ET | | | | |
| *707413 | Fail secure x key locks/unlocks control | | | | |
| *707415 | Fail secure x trim always operable | | | | |
| *707373 | Fail safe both sides | | | | |
| *707374 | Fail safe x fail secure | \$2,435.00 | \$2,512.00 | \$2,624.00 | \$2,698.00 |
| *707473 | Fail secure x fail safe | | | | |
| *707474 | Fail secure both sides | | | | |

*Specify voltage (12v or 24v) when ordering. **For Gramercy Series: 14, 15, 26, or 26D finishes are available on ET trim.

NOTES: 01, 10, 40, 73, & 74 outside functions are available with additional Auxiliary Control (106/113) Add \$697.00
 683 Kit for Single Door Application Requires 2 Kits (2 Pins/Kit)

| Kit for Single Door Application – Requires 2 Kits (2 Pins/Kit) | Price |
|---|---------|
| 683 Thermal pin is not needed for double latching applications. | \$97.00 |

MP-4 MULTI-POINT LOCKING HARDWARE

SARGENT®

AD7000 SERIES OPTIONS



ASSA ABLOY

USA & Canada Prices Effective June 3, 2019

| Options | Description | Price |
|---------|--|-----------------|
| 10 | SARGENT Signature System | \$58.00 / cyl. |
| 11 | SARGENT XC Key System (not available w/10, 10UL, 22, KESO) | No addition |
| 1160 | Sargent XC Large Format Interchangeable Plastic Disposable Construction Core | No addition |
| 1163 | Sargent XC Large Format Interchangeable Core Cylinder - Includes masterkeying charges | \$77.00 |
| 1164 | Sargent XC Large Format Interchangeable Construction Core Cylinder | \$77.00 |
| 1170 | Small Format interchangeable disposable construction core - to accept 7 Pin XC permanent core | No addition |
| 11727P | Small Format interchangeable keyed construction core - to accept 7 Pin XC permanent core | \$69.00 |
| 11737P | Small Format interchangeable core - to accept 7 pin XC permanent core | \$69.00 |
| 21 | SARGENT Construction Key System (lost ball) | \$16.00 /cyl. |
| 22 | SARGENT Construction Key System (split key) | \$32.00 /cyl. |
| 31 | For doors up to 2-1/4" | No addition |
| | For doors over 2-1/4" | Consult Factory |
| | For doors with panels | Consult Factory |
| 36 | 6 Lobe security head screws | \$60.00 |
| 37 | Spanner head screws | \$42.00 |
| 53 | Top bolt monitoring switch | \$237.00 |
| 54 | Monitor outside lever | \$214.00 |
| 55 | Monitor inside lever | \$223.00 |
| 60 | SARGENT Large Format Interchangeable Plastic Disposable Construction Core | No addition |
| 63 | SARGENT Large Format Interchangeable Core Cylinder includes master and grandmaster keying charge | \$77.00 /cyl. |
| 64 | SARGENT Large Format Interchangeable Construction Core Cylinder | \$77.00 |
| 6573 | Small Format 6 Pin Uncombined Core | \$59.00 / cyl. |
| 65737P | Small Format 7 Pin Uncombined Core | \$59.00 / cyl. |
| 70 | Small Format Interchangeable Disposable plastic Construction Core | No addition |
| 72 | Small Format Interchangeable 6-Pin Construction Core (7-pin with 11 option) | \$69.00 |
| 73 | Small Format interchangeable core 6-pin Includes MK and GMK keying charges | \$69.00 |
| 737P | Small Format interchangeable core 7-pin (refer to CK-12 for available keyways) Includes MK and GMK keying charges | \$69.00 |
| 75 | Tactile Warning - Milled on backside of inside lever (Not available with Studio & Coastal Levers and the A Lever) | \$72.00 |
| 76 | Tactile Warning - Milled on backside of outside lever (Not available with Studio & Coastal Levers and the A Lever) | \$72.00 |
| 77 | Tactile Warning - Milled on backside of both levers (Not available with Studio & Coastal Levers and the A Lever) | \$144.00 |
| F182 | SARGENT Keso Security, patent pending, cylinder – new key systems | \$84.00 / cyl. |
| F183 | SARGENT Keso Security, patent pending, removable core cylinder – new key systems | \$120.00 / cyl. |
| 81 | Cylinder to accept Keso (83) and Keso F1 (F183) Removable Core – no core provided | No addition |
| 82 | SARGENT Keso Security Cylinder (existing key systems only) | \$84.00 / cyl. |
| 83 | SARGENT Keso Security Removable Core Cylinder (existing key systems only) | \$120.00 / cyl. |
| 84 | SARGENT Keso Security Removable Construction Core Cylinder | See CK-18 |
| 85 | Tactile Warning - Abrasive coating on inside lever | \$45.00 |
| 86 | Tactile Warning - Abrasive coating on outside lever | \$45.00 |
| 87 | Tactile Warning - Abrasive coating on both levers | \$90.00 |
| 88 | Lever holdback | \$21.00 |
| BR | SARGENT Bump Resistant Cyls. (N/A w/10, 22, 30, 60, 63, 64, 70, 72, 73, 737P, KESO, SC, SE) | \$23.00 /cyl. |
| CPC | Clear Powder Coat over 26D. All orders will continue to be handled as a "special" when CPC is ordered. | \$62.00 |
| DG1 | Patented Degree DG1 Key System | No Addition |
| DG160 | Hardware prepared for DG1-6300 Lg. Format IC cores, supplied with temporary plastic construction cores | No addition |
| DG163 | Patented Degree DG1 Large Format Interchangeable Core Cylinder - Includes master keying charges | \$77.00 |
| DG164 | Hardware prepared for DG1-6300 Lg. Format IC cores, supplied with temporary keyed construction cores | \$77.00 |
| DG2 | Patented Degree DG2 Key System incorporating a locking sidebar | \$58.00/cyl. |
| DG260 | Hardware prepared for DG2-6300 Lg. Format IC cores, supplied with temporary plastic construction cores | No addition |
| DG263 | Patented Degree DG2 Large Format Interchangeable Core Cylinder - Includes master keying charges | \$135.00 |
| DG264 | Hardware prepared for DG2-6300 Lg. Format IC cores, supplied with temporary keyed construction cores | \$77.00 |
| DG3 | Patented Degree DG3 Key System incorporating a locking sidebar and UL437 listed | \$82.00/cyl. |
| DG360 | Hardware prepared for DG3-6300 Lg. Format IC cores, supplied with temporary plastic construction cores | No addition |
| DG363 | Patented Degree DG3 Large Format Interchangeable Core Cylinder - Includes master keying charges | \$159.00 |
| DG364 | Hardware prepared for DG3-6300 Lg. Format IC cores, supplied with temporary keyed construction cores | \$77.00 |
| ELR | Electric Latch Retraction | \$835.00 |
| LC | Less Cylinder | -\$89.00/cyl. |
| NB | Less Bottom Bolt | No addition |
| SC | Schlage C Keyway Cylinder 0-Bitted (Rim and #41 Mortise Cylinder Only) | No addition |
| SE | Schlage E Keyway Cylinder 0-Bitted (Rim and #41 Mortise Cylinder Only) | No addition |
| SG | MicroShield® an antimicrobial powder coat (not available with 10B) | \$82.00 |
| | Concealed/Surface Vertical Rod Device – Over 96" to 120" Height | \$60.00 |



Six Digit Function #:
 Series **70**
 Outside function **7001**
 Inside function **700106**

| AD7000 Series-Vertical Rod Lock | |
|---|---|
| ER/ES/ET Control  Standard Levers: A-B-E-F-J-L-P-W Coastal Levers: G-R-S-Y All Studio Collection Levers (Except Gramercy, Wooster Square, & Grant Park) | ER/ES/ET Control  Gramercy Levers: RAG-RAL-RAM-RAS-RCM-REM-RGM Wooster Square Levers: H001-H002-H003-H004-H005-H006 Grant Park Levers: H007-H008-H009-H010-H011 |
| Finishes listed below are for ET trim on both sides. Refer to catalog for available trims, trim finishes and how to order. | |

Please specify hand when ordering.

| AD7000 Series Function | Description | 10BE/26D/BSP/WSP | 03/04/09/10/10B/10BL/14/15/20D/26 | Gramercy:10BE/BSP/WSP/629/630 Wstr Sq/Grant Park: 10BE/26D/BSP/WSP | 03/04/09/10/10B/10BL/14/15/20D/26 |
|---|--|------------------|-----------------------------------|--|-----------------------------------|
| AD 700106 | Blank plate x key operates ET | | | | |
| AD 700113 | Blank plate x key lock/unlocks control | | | | |
| AD 700115 | Blank plate x trim always operable | | | | |
| AD 700143 | Blank plate x free wheeling key engages/disengages lever | | | | |
| AD 700146 | Blank plate x free wheeling key operates ET | | | | |
| AD 700606 | Key operates ET both sides | | | | |
| AD 700613 | Key operates ET x key lock/unlocks control | | | | |
| AD 700615 | Key operates ET x trim always operable | | | | |
| AD 701006 | Dummy trim x key operates ET | | | | |
| AD 701013 | Dummy trim x key lock/unlocks control | \$2,085.00 | \$2,162.00 | \$2,274.00 | \$2,348.00 |
| AD 701015 | Dummy trim (lever rigid) x trim always operable | | | | |
| AD 701306 | Key lock/unlock control x key operates ET | | | | |
| AD 701313 | Key lock/unlocks control both sides | | | | |
| AD 701315 | Key locks/unlocks control x trim always operable | | | | |
| AD 701506 | Trim always operable x key operates ET | | | | |
| AD 701513 | Trim always operable x key lock/unlocks control | | | | |
| AD 701515 | Trim always operable both sides | | | | |
| AD 701543 | Trim always operable x fw key engages/disengages lever | | | | |
| AD 701546 | Trim always operable x fw key operates ET | | | | |
| AD 701616 | Classroom both sides | | | | |
| AD7000 Series With Freewheeling Trim | | | | | |
| AD 704043 | Dummy trim x key engages/disengages lever | | | | |
| AD 704046 | Dummy trim x key operates ET | | | | |
| AD 704315 | Key engages/disengages Lever | | | | |
| AD 704340 | Key engages/disengages lever x dummy trim | | | | |
| AD 704343 | Key engages/disengages lever both sides | \$2,085.00 | \$2,162.00 | \$2,274.00 | \$2,348.00 |
| AD 704346 | Key engages/disengages lever x key operates ET | | | | |
| AD 704615 | Key operates ET x trim always operable | | | | |
| AD 704640 | Key operates ET x dummy trim | | | | |
| AD 704643 | Key operates ET x key engages/disengages lever | | | | |
| AD 704646 | Key operates ET on both sides | | | | |
| Electromechanical | | | | | |
| AD *700173 | Blank plate x fail safe | | | | |
| AD *700174 | Blank plate x fail secure | | | | |
| AD *700673 | Key operates ET x fail safe | | | | |
| AD *700674 | Key operates ET x fail secure | | | | |
| AD *701073 | Dummy trim x fail safe | | | | |
| AD *701074 | Dummy trim x fail secure | | | | |
| AD *707306 | Fail safe x key operates ET | \$2,259.00 | \$2,335.00 | \$2,449.00 | \$2,523.00 |
| AD *707313 | Fail safe x key locks/unlocks control | | | | |
| AD *707315 | Fail safe x trim always operable | | | | |
| AD *707406 | Fail secure x key operates ET | | | | |
| AD *707413 | Fail secure x key locks/unlocks control | | | | |
| AD *707415 | Fail secure x trim always operable | | | | |
| AD *707373 | Fail safe both sides | | | | |
| AD *707374 | Fail safe x fail secure | \$2,435.00 | \$2,512.00 | \$2,624.00 | \$2,698.00 |
| AD *707473 | Fail secure x fail safe | | | | |
| AD *707474 | Fail secure both sides | | | | |

*Specify voltage (12v or 24v) when ordering.

**For Gramercy Series: 14, 15, 26, or 26D finishes are available on ET trim.

NOTES: 01, 10, 40, 73, & 74 outside functions are available with additional Auxiliary Control (106/113)

Add \$697.00

MP-6 MULTI-POINT LOCKING HARDWARE

SARGENT®

WD7000 SERIES OPTIONS

ASSA ABLOY



USA & Canada Prices Effective June 3, 2019

| Options | Description | Price |
|---------|--|-----------------|
| 10 | SARGENT Signature System | \$58.00 / cyl. |
| 11 | SARGENT XC Key System (not available w/10, 10UL, 22, KESO) | No addition |
| 1160 | Sargent XC Large Format Interchangeable Plastic Disposable Construction Core | No addition |
| 1163 | Sargent XC Large Format Interchangeable Core Cylinder - Includes masterkeying charges | \$77.00 |
| 1164 | Sargent XC Large Format Interchangeable Construction Core Cylinder | \$77.00 |
| 1170 | Small Format interchangeable disposable construction core - to accept 7 Pin XC permanent core | No addition |
| 11727P | Small Format interchangeable keyed construction core - to accept 7 Pin XC permanent core | \$69.00 |
| 11737P | Small Format interchangeable core - to accept 7 pin XC permanent core | \$69.00 |
| 12 | UL Fire Label Exit Devices (Not available on single door applications) | \$177.00 |
| 21 | SARGENT Construction Key System (lost ball) | \$16.00 /cyl. |
| 22 | SARGENT Construction Key System (split key) | \$32.00 /cyl. |
| 31 | For doors up to 2-1/4" | No addition |
| | For doors over 2-1/4" | Consult Factory |
| | For doors with panels | Consult Factory |
| 36 | 6 Lobe security head screws | \$60.00 |
| 37 | Spanner head screws | \$42.00 |
| 53 | Top bolt monitoring switch | \$237.00 |
| 54 | Monitor outside lever | \$214.00 |
| 55 | Monitor inside lever | \$223.00 |
| 60 | SARGENT Large Format Interchangeable Plastic Disposable Construction Core | No addition |
| 63 | SARGENT Large Format Interchangeable Core Cylinder includes master and grandmaster keying charge | \$77.00 /cyl. |
| 64 | SARGENT Large Format Interchangeable Construction Core Cylinder | \$77.00 |
| 6573 | Small Format 6 Pin Uncombined Core | \$59.00 / cyl. |
| 65737P | Small Format 7 Pin Uncombined Core | \$59.00 / cyl. |
| 70 | Small Format Interchangeable Disposable plastic Construction Core | No addition |
| 72 | Small Format Interchangeable 6-Pin Construction Core (7-pin with 11 option) | \$69.00 |
| 73 | Small Format interchangeable core 6-pin Includes MK and GMK keying charges | \$69.00 |
| 737P | Small Format interchangeable core 7-pin (refer to CK-12 for available keyways) Includes MK and GMK keying charges | \$69.00 |
| 75 | Tactile Warning - Milled on backside of inside lever (Not available with Studio & Coastal Levers and the A Lever) | \$72.00 |
| 76 | Tactile Warning - Milled on backside of outside lever (Not available with Studio & Coastal Levers and the A Lever) | \$72.00 |
| 77 | Tactile Warning - Milled on backside of both levers (Not available with Studio & Coastal Levers and the A Lever) | \$144.00 |
| F182 | SARGENT Keso Security, patent pending, cylinder – new key systems | \$84.00 / cyl. |
| F183 | SARGENT Keso Security, patent pending, removable core cylinder – new key systems | \$120.00 / cyl. |
| 81 | Cylinder to accept Keso (83) and Keso F1 (F183) Removable Core – no core provided | No addition |
| 82 | SARGENT Keso Security Cylinder (existing key systems only) | \$84.00 / cyl. |
| 83 | SARGENT Keso Security Removable Core Cylinder (existing key systems only) | \$120.00 / cyl. |
| 84 | SARGENT Keso Security Removable Construction Core Cylinder | See CK-18 |
| 85 | Tactile Warning - Abrasive coating on inside lever | \$45.00 |
| 86 | Tactile Warning - Abrasive coating on outside lever | \$45.00 |
| 87 | Tactile Warning - Abrasive coating on both levers | \$90.00 |
| 88 | Lever holdback | \$21.00 |
| BR | SARGENT Bump Resistant Cyls. (N/A w/10, 22, 30, 60, 63, 64, 70, 72, 73, 737P, KESO, SC, SE) | \$23.00/cyl. |
| CPC | Clear Powder Coat over 26D. All orders will continue to be handled as a "special" when CPC is ordered. | \$62.00 |
| DG1 | Patented Degree DG1 Key System | No Addition |
| DG160 | Hardware prepared for DG1-6300 Lg. Format IC cores, supplied with temporary plastic construction cores | No addition |
| DG163 | Patented Degree DG1 Large Format Interchangeable Core Cylinder - Includes master keying charges | \$77.00 |
| DG164 | Hardware prepared for DG1-6300 Lg. Format IC cores, supplied with temporary keyed construction cores | \$77.00 |
| DG2 | Patented Degree DG2 Key System incorporating a locking sidebar | \$58.00/cyl. |
| DG260 | Hardware prepared for DG2-6300 Lg. Format IC cores, supplied with temporary plastic construction cores | No addition |
| DG263 | Patented Degree DG2 Large Format Interchangeable Core Cylinder - Includes master keying charges | \$135.00 |
| DG264 | Hardware prepared for DG2-6300 Lg. Format IC cores, supplied with temporary keyed construction cores | \$77.00 |
| DG3 | Patented Degree DG3 Key System incorporating a locking sidebar and UL437 listed | \$82.00/cyl. |
| DG360 | Hardware prepared for DG3-6300 Lg. Format IC cores, supplied with temporary plastic construction cores | No addition |
| DG363 | Patented Degree DG3 Large Format Interchangeable Core Cylinder - Includes master keying charges | \$159.00 |
| DG364 | Hardware prepared for DG3-6300 Lg. Format IC cores, supplied with temporary keyed construction cores | \$77.00 |
| ELR | Electric Latch Retraction | \$835.00 |
| LC | Less Cylinder | -\$89.00/cyl. |
| NB | Less Bottom Bolt | No addition |
| SC | Schlage C Keyway Cylinder 0-Bitted (Rim and #41 Mortise Cylinder Only) | No addition |
| SE | Schlage E Keyway Cylinder 0-Bitted (Rim and #41 Mortise Cylinder Only) | No addition |
| SG | MicroShield® an antimicrobial powder coat (not available with 10B) | \$82.00 |
| | Concealed/Surface Vertical Rod Device – Over 96" to 120" Height | \$60.00 |



Six Digit Function #:
 Series **70**
 Outside function **7001**
 Inside function **700106**

Please specify hand when ordering.

| WD7000 Series-Vertical Rod Lock | |
|---|---|
| ER/ES Control | ER/ES Control |
|  |  |
| Standard Levers: A-B-E-F-J-L-P-W Coastal Levers: G-R-S-Y All Studio Collection Levers (Except Gramercy, Wooster Square, & Grant Park) | Gramercy Levers: RAG-RAL-RAM-RAS-RCM-REM-RGM Wooster Square Levers: H001-H002-H003-H004-H005-H006 Grant Park Levers: H007-H008-H009-H010-H011 |
| Finishes listed below are for ET trim on both sides. Refer to catalog for available trims, trim finishes and how to order. | |

| WD7000 Series Function | Description | 10BE/26D/ BSP/WSP | 03/04/09/ 10/10B/10BL/ 14/15/20D/26 | Gramercy:10BE/BSP/ WSP/629/630 Wstr Sq/Grant Park: 10BE/26D/BSP/WSP | 03/04/09/10/ 10B/10BL/14/ 15/20D/26 |
|---|--|----------------------|---|--|---|
| WD 700106 | Blank plate x key operates ER/ES | | | | |
| WD 700113 | Blank plate x key lock/unlocks control | | | | |
| WD 700115 | Blank plate x trim always operable | | | | |
| WD 700143 | Blank plate x free wheeling key engages/disengages lever | | | | |
| WD 700146 | Blank plate x free wheeling key operates ER/ES | | | | |
| WD 700606 | Key operates ER/ES both sides | | | | |
| WD 700613 | Key operates ER/ES x key lock/unlocks control | | | | |
| WD 700615 | Key operates ER/ES x trim always operable | | | | |
| WD 701006 | Dummy trim x key operates ER/ES | | | | |
| WD 701013 | Dummy trim x key lock/unlocks control | \$2,085.00 | \$2,162.00 | \$2,274.00 | \$2,348.00 |
| WD 701015 | Dummy trim (lever rigid) x trim always operable | | | | |
| WD 701306 | Key lock/unlock control x key operates ER/ES | | | | |
| WD 701313 | Key lock/unlocks control both sides | | | | |
| WD 701315 | Key locks/unlocks control x trim always operable | | | | |
| WD 701506 | Trim always operable x key operates ER/ES | | | | |
| WD 701513 | Trim always operable x key lock/unlocks control | | | | |
| WD 701515 | Trim always operable both sides | | | | |
| WD 701543 | Trim always operable x fw key engages/disengages lever | | | | |
| WD 701546 | Trim always operable x fw key operates ER/ES | | | | |
| WD 701616 | Classroom both sides | | | | |
| WD7000 Series With Freewheeling Trim | | | | | |
| WD 704043 | Dummy trim x key engages/disengages lever | | | | |
| WD 704046 | Dummy trim x key operates ER/ES | | | | |
| WD 704315 | Key engages/disengages Lever | | | | |
| WD 704340 | Key engages/disengages lever x dummy trim | | | | |
| WD 704343 | Key engages/disengages lever both sides | \$2,085.00 | \$2,162.00 | \$2,274.00 | \$2,348.00 |
| WD 704346 | Key engages/disengages lever x key operates ER/ES | | | | |
| WD 704615 | Key operates ER/ES x trim always operable | | | | |
| WD 704640 | Key operates ER/ES x dummy trim | | | | |
| WD 704643 | Key operates ER/ES x key engages/disengages lever | | | | |
| WD 704646 | Key operates ER/ES on both sides | | | | |
| Electromechanical | | | | | |
| WD *700173 | Blank plate x fail safe | | | | |
| WD *700174 | Blank plate x fail secure | | | | |
| WD *700673 | Key operates ET x fail safe | | | | |
| WD *700674 | Key operates ET x fail secure | | | | |
| WD *701073 | Dummy trim x fail safe | | | | |
| WD *701074 | Dummy trim x fail secure | | | | |
| WD *707306 | Fail safe x key operates ER/ES | \$2,259.00 | \$2,335.00 | \$2,449.00 | \$2,523.00 |
| WD *707313 | Key lock/unlock control both sides | | | | |
| WD *707315 | Fail safe x trim always operable | | | | |
| WD *707406 | Fail secure x key operates ER/ES | | | | |
| WD *707413 | Fail secure x key locks/unlocks control | | | | |
| WD *707415 | Fail secure x trim always operable | | | | |
| WD *707373 | Fail safe both sides | | | | |
| WD *707374 | Fail safe x fail secure | \$2,435.00 | \$2,512.00 | \$2,624.00 | \$2,698.00 |
| WD *707473 | Fail secure x fail safe | | | | |
| WD *707474 | Fail secure both sides | | | | |

*Specify voltage (12v or 24v) when ordering.

**For Gramercy Series: 14, 15, 26, or 26D finishes are available on ET trim.

NOTES: 01, 10, 40, 73, & 74 outside functions are available with additional Auxiliary Control (106/113)

Add \$697.00

MP-8 MULTI-POINT LOCKING HARDWARE

SARGENT®

ER/ES/ET LEVER CONTROL TRIM

ASSA ABLOY

USA & Canada Prices Effective June 3, 2019

ER/ES/ET Control

Standard Levers:
A-B-E-F-J-L-P-W

Coastal Levers:
G-R-S-Y

All Studio Collection Levers
(Except Gramercy, Wooster Square,
& Grant Park)



All Trim is priced with cylinder where required.

Refer to catalog for available trims, trim finishes and how to order.

WD7000 Series is only available with ER and ES trim.

NOTE: Must specify MP- option when ordering 700 Series Inside Lever Type Trims

| <u>700 Series ER/ES/ET Lever Type Trim Function Series</u> (Available as Listed) | | <u>Finish</u> |
|--|---------------------------------|--|
| TRIM# | FUNCTION | 03/04/09/10/10B/10BE/10BL/ 14/15/20D/26/26D/BSP/WSP |
| 701-2 | 01 Blank case | |
| 706-2 | 06 Key operates | |
| 710-2 | 10 Dummy trim lever rigid | \$697.00 |
| 713-2 | 13 Key locks/unlocks control | |
| 715-2 | 15 Trim always operable | |
| 716-2 | 16 classroom | |
| 773-2 | 73 Fail Safe | \$983.00 |
| 774-2 | 74 Fail Secure | |
| <u>700 Series Freewheeling ER/ES/ET Lever Type Trim Function Series</u> (Available as Listed) | | <u>Finish</u> |
| TRIM# | FUNCTION | 03/04/09/10/10B/10BE/10BL/ 14/15/20D/26/26D/BSP/WSP |
| 740-2 | 40 Dummy trim (lever rotates) | |
| 743-2 | 43 Key engages/disengages lever | \$697.00 |
| 746-2 | 46 Key operates control | |

ER/ES/ET LEVER CONTROL TRIM GRAMERCY SERIES DESIGN

USA & Canada Prices Effective June 3, 2019

ER/ES/ET Control

Gramercy Levers:
RAG-RAL-RAM-RAS-
RCM-REM-RGM

Wooster Square Levers:
H001-H002-H003-H004-H005-H006

Grant Park Levers:
H007-H008-H009-H010-H011



Shown:
ETRAM



Shown:
ERRAM



Shown:
ESRAM

All Exit Trim is priced with cylinder where required.

Refer to catalog for available trims, trim finishes and how to order.

WD7000 Series is only available with ER and ES trim.

NOTE: Must specify MP- option when ordering 700 Series Inside Lever Type Trims

| <u>700 Series ER/ES/ET Lever Type Trim Function Series</u> | | 03/04/09/10/10B/ 10BE/10BL/14/15/20D/ 26/26D/BSP/WSP/629*/630* |
|---|---------------------------------|--|
| TRIM# | FUNCTION | |
| 701-2 | 01 Blank case | |
| 706-2 | 06 Key operates | |
| 710-2 | 10 Dummy trim lever rigid | \$920.00 |
| 713-2 | 13 Key locks/unlocks control | |
| 715-2 | 15 Trim always operable | |
| 716-2 | 16 classroom | |
| 773-2 | 73 Fail safe | \$1,160.00 |
| 774-2 | 74 Fail secure | |
| <u>700 Series Freewheeling ER/ES/ET Lever Type Trim Function Series</u> | | 03/04/09/10/10B/ 10BE/10BL/14/15/20D/ 26/26D/BSP/WSP/629*/630* |
| TRIM# | FUNCTION | |
| 740-2 | 40 Dummy trim (lever rotates) | |
| 743-2 | 43 Key engages/disengages lever | \$920.00 |
| 746-2 | 46 Key operates control | |

*Not available with Wooster Square and Grant Park Levers.

MP-10 MULTI-POINT LOCKING HARDWARE

SARGENT®

ASSA ABLOY

ROD REPLACEMENT, 7000 STRIKES, LOCKING SLIDE, AND SPINDLE KITS

USA & Canada Prices Effective June 3, 2019

| Top Rod & Bolt Kits (Door & mounting height are required) | | |
|--|-------------------------------------|--------------|
| Part | Description | Price |
| MD694T | 7000 | |
| WD694T | WD-7000 | \$85.00 |
| WDA694T | WD-7000 x AUX | |
| Bottom Rod & Bolt Kits (Mounting height is required) | | |
| 694B | 7000, WD-7000,WD-7000 x Aux | \$67.00 |
| Top Rod Kits (Door & mounting height are required) | | |
| MD663T | 7000 | |
| WD663T | WD-7000 | \$49.00 |
| WDA663T | WD-7000 x AUX | |
| Bottom Rod Kit (Mounting height is required) | | |
| 663B | 7000, WD-7000,WD-7000 x Aux | \$43.00 |
| Strikes Parts | | |
| 606 | Bottom Strike Pack | \$58.82 |
| 650 | Top Strike Pack | \$34.59 |
| Locking Slide Replacement Kit | | |
| 607-1 | Locking Slide Replacement Kit (713) | \$108.00 |
| 607-2 | Locking Slide Replacement Kit (706) | \$108.00 |

USA & Canada Prices Effective June 3, 2019

| Part # | Description | Price |
|---------|---|----------|
| 01-0696 | Spirol Pin | \$0.97 |
| 01-1027 | Extension Connector | \$0.85 |
| 01-1182 | Cap Screw | \$2.39 |
| 01-1183 | Machine Screw PH Truss Head | \$0.66 |
| 01-1479 | #10-32 x .500 PH FL HD MH Screw | \$0.19 |
| 01-4383 | Machine Screw | 0.49 |
| 01-4410 | #4-40 UNC-2A X 1/4 Screw | \$0.19 |
| 01-4451 | Thru Bolt 1/4-20 x 2 3/8" (1 3/4" door) | \$1.68 |
| 01-4468 | Thru Bolt 1/4-20 x 3" (1 3/4" door) | \$1.48 |
| 01-4507 | Groove Pin Double Headed | \$0.56 |
| 01-4560 | #3-48 x .125 PH RD HD Machine Screw | \$0.81 |
| 01-9105 | Tooth Lock Washer | \$0.06 |
| 68-0888 | Bottom Plate | \$12.54 |
| 68-1270 | Extension Connector | \$27.79 |
| 68-1286 | Top Rod Extension | \$32.15 |
| 68-1393 | Retainer Plate | \$8.37 |
| 68-3627 | Inner Case Assy (12-) | \$358.75 |
| 68-3677 | Screw Pack | \$16.52 |
| 68-4840 | Latch Bolt Assy | \$34.91 |
| 68-5374 | Top Case Assy (Standard) | \$198.45 |
| 68-7546 | Motor Actuator Assy | \$100.05 |
| 82-0184 | Cap Nut | \$7.10 |
| 94-2008 | Inner Case Assy (STD) | \$262.71 |
| 94-2414 | Inner Case Assy (12-, 53-) | \$678.92 |
| 94-2423 | Inner Case Assy (WD) | \$262.71 |
| 94-2424 | Inner Case Assy (53-WD) | \$508.54 |
| 97-0347 | Locking Slide Spring | \$5.69 |
| 97-0350 | Collar | \$16.47 |
| 97-0425 | Hub Spring | \$10.11 |
| 97-0475 | Locking Slide | \$54.53 |
| 97-0476 | Locking Slide | \$63.74 |
| 97-0477 | Bushing Insert | \$8.10 |
| 97-0478 | Lower Hub Plate | \$5.03 |
| 97-0479 | Spindle Lock | \$33.97 |
| 97-0522 | Lower Hub Plate | \$2.20 |
| 97-0528 | Locking Piece | \$2.56 |
| 97-0557 | Fusable Link | \$0.25 |
| 97-0566 | Hub Spring (J Lever Only) | \$10.11 |
| 97-0571 | Locking Slide Spring | \$0.73 |
| 97-0573 | Spindle | \$6.75 |
| 97-0581 | Retaining Plate | \$3.23 |
| 97-0582 | Spacer | \$2.01 |
| 97-0603 | Cam | \$5.25 |
| 97-3098 | Spindle Assy | \$44.40 |

MP-12 MULTI-POINT LOCKING HARDWARE

SARGENT®

FM6100 OPTIONS

ASSA ABLOY

USA & Canada Prices Effective June 3, 2019

| Options | Description | Price |
|---------|---|-----------------|
| 10 | SARGENT Signature System | \$58.00 / cyl. |
| 11 | SARGENT XC Key System (not available with 10, 22, SC, SE options) | No addition |
| 1160 | Sargent XC Large Format Interchangeable Plastic Disposable Construction Core | No addition |
| 1163 | Sargent XC Large Format Interchangeable Core Cylinder - Includes masterkeying charges | \$77.00 |
| 1164 | Sargent XC Large Format Interchangeable Construction Core Cylinder | \$77.00 |
| 1170 | Small Format interchangeable disposable construction core - to accept 7 Pin XC permanent core | No addition |
| 11727P | Small Format interchangeable keyed construction core - to accept 7 Pin XC permanent core | \$69.00 |
| 11737P | Small Format interchangeable core - to accept 7 pin XC permanent core | \$69.00 |
| 21 | SARGENT Construction Key System (lost ball) Standard on new systems est. since 5/1/96 | \$16.00 /cyl. |
| 22 | Construction Key System (split key) To be used on pre-established split key systems only | \$32.00 /cyl. |
| 36 | 6 Lobe security head screws | \$58.00 |
| 60 | SARGENT Large Format Interchangeable Plastic Disposable Construction Core | No addition |
| 63 | SARGENT Large Format Interchangeable Core Cylinder includes master and grandmaster keying charge | \$77.00 /cyl. |
| 64 | SARGENT Large Format Interchangeable Construction Core Cylinder | \$77.00 |
| 6573 | Small Format 6 Pin Uncombined Core | \$59.00 / cyl. |
| 65737P | Small Format 7 Pin Uncombined Core | \$59.00 / cyl. |
| 70 | Small Format interchangeable disposable plastic construction core (Not available with J lever) | No addition |
| 72 | Small Format interchangeable 6-Pin construction core (not available with J lever) | \$69.00 |
| 73 | Small Format interchangeable core 6-pin Includes MK and GMK keying charges (Not available with J lever) | \$69.00 |
| 737P | Small Format interchangeable core 7-pin (refer to CK-12 for available keyways) Includes MK and GMK keying charges (Not available with J lever) | \$69.00 |
| 75 | Tactile Warning - Milled on backside of inside lever (Not available with Studio & Coastal Levers and the A Lever) | \$72.00 |
| 76 | Tactile Warning - Milled on backside of outside lever (Not available with Studio & Coastal Levers and the A Lever) | \$72.00 |
| 77 | Tactile Warning - Milled on backside of both levers (Not available with Studio & Coastal Levers and the A Lever) | \$144.00 |
| F182 | SARGENT Keso Security, patent pending, cylinder – new key systems | \$84.00 / cyl. |
| F183 | SARGENT Keso Security, patent pending, removable core cylinder – new key systems | \$120.00 / cyl. |
| 81 | Cylinder to accept Keso (83) and Keso F1 (F183) Removable Core – no core provided | No Addition |
| 82 | SARGENT Keso Security Cylinder (existing key systems only) | \$84.00 / cyl. |
| 83 | SARGENT Keso Security Removable Core Cylinder (existing key systems only) | \$120.00 / cyl. |
| 84 | SARGENT Keso Security Removable Construction Core Cylinder | See page CK-18 |
| 85 | Tactile Warning - Abrasive coating on inside lever | \$45.00 |
| 86 | Tactile Warning - Abrasive coating on outside lever | \$45.00 |
| 87 | Tactile Warning - Abrasive coating on both levers | \$90.00 |
| BR | SARGENT Bump Resistant Cyls. (N/A w/10, 22, 30, 60, 63, 64, 70, 72, 73, 737P, KESO, SC, SE) | \$23.00 /cyl. |
| CPC | Clear Powder Coat over 26D. All orders will continue to be handled as a "special" when CPC is ordered. | \$62.00 |
| DG1 | Patented Degree DG1 Key System | No Addition |
| DG160 | Hardware prepared for DG1-6300 Lg. Format IC cores, supplied with temporary plastic construction cores | No addition |
| DG163 | Patented Degree DG1 Large Format Interchangeable Core Cylinder - Includes master keying charges | \$77.00 |
| DG164 | Hardware prepared for DG1-6300 Lg. Format IC cores, supplied with temporary keyed construction cores | \$77.00 |
| DG2 | Patented Degree DG2 Key System incorporating a locking sidebar | \$58.00/cyl. |
| DG260 | Hardware prepared for DG2-6300 Lg. Format IC cores, supplied with temporary plastic construction cores | No addition |
| DG263 | Patented Degree DG2 Large Format Interchangeable Core Cylinder - Includes master keying charges | \$135.00 |
| DG264 | Hardware prepared for DG2-6300 Lg. Format IC cores, supplied with temporary keyed construction cores | \$77.00 |
| DG3 | Patented Degree DG3 Key System incorporating a locking sidebar and UL437 listed | \$82.00/cyl. |
| DG360 | Hardware prepared for DG3-6300 Lg. Format IC cores, supplied with temporary plastic construction cores | No addition |
| DG363 | Patented Degree DG3 Large Format Interchangeable Core Cylinder - Includes master keying charges | \$159.00 |
| DG364 | Hardware prepared for DG3-6300 Lg. Format IC cores, supplied with temporary keyed construction cores | \$77.00 |
| LC | Less Cylinder | -\$89.00/cyl. |
| SC | Schlage C Keyway Cylinder 0-Bitted (Rim and #41 Mortise Cylinder Only) | No Addition |
| SE | Schlage E Keyway Cylinder 0-Bitted (Rim and #41 Mortise Cylinder Only) | No Addition |
| SG | MicroShield® an antimicrobial powder coat | \$82.00 |

USA & Canada Prices Effective June 3, 2019



Please specify hand when ordering.

FM6100 Series – Storm Shutter Multi-Point Auto Deadlocking System



ECL



ECMH

Escutcheon: EC Control

Lever A-B-E-F-J-L-P-W

Coastal Series Y-G-R-S

All Studio Collection Levers (Except Gramercy,
Wooster Square, & Grant Park)

Finishes listed below are for ET trim on both sides. Refer to catalog for available trims, trim finishes and how to order.

| | | | Finish | |
|---|----------|---|--|---------------------------------------|
| | | | 10BE/26D/ BSP/WSP | 03/04/09/10/10B/ 10BL/14/15/20D/26 |
| FM6100 Series | | | | |
| Option | Function | Description | | |
| FM | 6101 | Passage Lever x Blank Plate | | |
| FM | 6113 | Classroom | \$3,711.00 | \$3,723.00 |
| FM | 6115 | Passage or Closet | | |
| 700 Series Inside EC Control Lever Type Trim | | | 03/04/09/10/10B/10BE/10BL/ 14/15/20D/26/26D | |
| Option | Function | Description | | |
| MP | 715-3 | Used with all available outside functions | | \$1,112.00 |
| 700 Series EC Lever Type Trim | | | 03/04/09/10/10B/10BE/10BL/ 14/15/20D/26/26D | |
| Trim # | Function | | | |
| 701-3 | 6101 | | | |
| 713-3 | 6113 | | | \$1,112.00 |
| 715-3 | 6115 | | | |

How to order: Trim# x EC Control x Lever Design x Finish x Hand

Example: 701-3 x ECL x 26D x RH

MP-14 MULTI-POINT LOCK

SARGENT®

FM7300 SERIES OPTIONS

ASSA ABLOY

USA & Canada Prices Effective June 3, 2019

| Options | Description | Price |
|---------|---|-----------------|
| 3 | Stainless steel hub | \$63.00 |
| 10 | SARGENT Signature Key System | \$58.00 / cyl. |
| 11† | SARGENT XC Key System (not available w/10, KESO, SC, SE) | No addition |
| 1160 | SARGENT XC Large Format Interchangeable Plastic Disposable Construction Core | No addition |
| 1163 | SARGENT XC Large Format Interchangeable Core Cylinder - Includes masterkeying charges | \$77.00 |
| 1164 | SARGENT XC Large Format Interchangeable Construction Core Cylinder | \$77.00 |
| 1170 | Small Format interchangeable disposable construction core - to accept 7 Pin XC permanent core | No addition |
| 11727P | Small Format interchangeable keyed construction core - to accept 7 Pin XC permanent core | \$69.00 |
| 11737P | Small Format interchangeable core - to accept 7 pin XC permanent core | \$69.00 / cyl. |
| 21† | SARGENT Construction Key System (lost ball) Standard on all new systems established since 5/1/96 | \$16.00 / cyl. |
| 22† | SARGENT Construction Key System (split key) To be used on pre-established split key systems only | \$32.00 / cyl. |
| 36 | 6 Lobe security head screws | \$58.00 |
| 49 | Occupancy Indicator with emergency Release | \$92.00 |
| 50 | Secured Indicator Rose – Available with 24 and 25 functions only | \$62.00 |
| 60 | SARGENT Large Format Interchangeable Plastic Disposable Construction Core | No addition |
| 63 | SARGENT Large Format Interchangeable core cylinder, includes master keying charges | \$77.00 / cyl |
| 64 | SARGENT Large Format Interchangeable Construction Core Cylinder | \$77.00 |
| 6573† | Small Format 6-Pin Uncombined Core (Refer to CK-12) | \$59.00 / cyl. |
| 65737P† | Small Format 7-Pin Uncombined Core (Refer to CK-12) | \$59.00 / cyl. |
| 70† | Small Format interchangeable disposable plastic construction core | No addition |
| 72† | Small Format interchangeable 6-Pin construction core | \$69.00 |
| 73† | Small Format interchangeable core 6-pin Includes MK and GMK keying charges | \$69.00 / cyl |
| 737P† | Small Format interchangeable core 7-pin (refer to CK-12 for available keyways) Includes MK and GMK keying charges | \$69.00 / cyl |
| 75 | Tactile Warning - Milled Inside Lever | \$72.00 |
| 76 | Tactile Warning - Milled Outside Lever | \$72.00 |
| 77 | Tactile Warning - Milled Outside and Inside Lever | \$144.00 |
| 81† | Cylinder to accept Keso (83) and Keso F1 (F183) removable core – no core provided | No addition |
| F182† | SARGENT Keso Security Cylinder – patented – new key systems | \$84.00 / cyl. |
| F183† | SARGENT Keso Security Removable Core Cylinder – patented – new key systems | \$120.00 / cyl. |
| 82† | SARGENT Keso Security Cylinder (For existing systems only) | \$84.00 / cyl. |
| 83† | SARGENT Keso Security Removable Core Cylinder (For existing systems only) | \$120.00 / cyl. |
| 84† | SARGENT Keso Security Removable Construction Core Cylinder | See CK-18 |
| 85 | Tactile Warning - Abrasive Coating on Inside Lever | \$45.00 |
| 86 | Tactile Warning - Abrasive Coating on Outside Lever | \$45.00 |
| 87 | Tactile Warning - Abrasive Coating on Outside & Inside Lever | \$90.00 |
| BR | SARGENT Bump Resistant Cylinders (N/A w/10, 22, 30, 60, 63, 64, 70, 72, 73, 737P, KESO, SC, & SE options) | \$23.00 /cyl. |
| DX | Deadbolt Monitoring | \$182.00 |
| DG1 | Patented Degree DG1 Key System | No Addition |
| DG160 | Hardware prepared for DG1-6300 Lg. Format IC cores, supplied with temporary plastic construction cores | No addition |
| DG163 | Patented Degree DG1 Large Format Interchangeable Core Cylinder - Includes master keying charges | \$77.00 |
| DG164 | Hardware prepared for DG1-6300 Lg. Format IC cores, supplied with temporary keyed construction cores | \$77.00 |
| DG2 | Patented Degree DG2 Key System incorporating a locking sidebar | \$58.00/cyl. |
| DG260 | Hardware prepared for DG2-6300 Lg. Format IC cores, supplied with temporary plastic construction cores | No addition |
| DG263 | Patented Degree DG2 Large Format Interchangeable Core Cylinder - Includes master keying charges | \$135.00 |
| DG264 | Hardware prepared for DG2-6300 Lg. Format IC cores, supplied with temporary keyed construction cores | \$77.00 |
| DG3 | Patented Degree DG3 Key System incorporating a locking sidebar and UL437 listed | \$82.00/cyl. |
| DG360 | Hardware prepared for DG3-6300 Lg. Format IC cores, supplied with temporary plastic construction cores | No addition |
| DG363 | Patented Degree DG3 Large Format Interchangeable Core Cylinder - Includes master keying charges | \$159.00 |
| DG364 | Hardware prepared for DG3-6300 Lg. Format IC cores, supplied with temporary keyed construction cores | \$77.00 |
| LB | Extra large thumbturn | \$16.00 |
| LC | Less Cylinder | -\$89.00/cyl. |
| SC† | Schlage "C" Keyway cylinder, (Number 41 Cylinder Only, 0 bitted) | No addition |
| SE† | Schlage "E" Keyway cylinder, (Number 41 Cylinder Only, 0 bitted) | No addition |
| SG | MicroShield® – an antimicrobial powder coat finish | \$82.00 |
| T1 | Decorative thumbturn; backplate matches rose design chosen | No Addition |
| T2 | Decorative square thumbturn; backplate matches rose design chosen | No Addition |
| T3 | Decorative cylinder thumbturn; backplate matches rose design chosen | No Addition |

NOTES: † Not avail. with 60, 63, 64 options

CPC Clear Powder Coat over 26D/32D \$62.00
All orders will continue to be handled as a "special" when CPC is ordered.

USA & Canada Prices Effective June 3, 2019

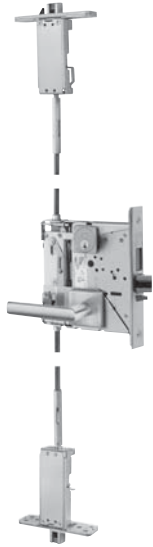

FM7300 SERIES

Standard Rose Designs: O, E, L, LN

Standard Lever Designs: A, B, E, F, J, L, P, W

Studio Rose Designs: E2, E3, E4, CO, TO, CR, TR, LN, O

Studio Collection Levers Except for Gramercy, Wooster Square, & Grant Park

For Gramercy, Wooster Square, & Grant Park Levers – Add \$138.00 to below prices

Please specify hand when ordering.

Finishes listed below are for ET trim on both sides.
Refer to catalog for available trims, trim finishes and how to order.

| | | | Finish | |
|--|----------------|--------------------------------------|----------------------|---|
| FM7300 Series Single Cylinder with Deadbolt | | | 10BE/26D/ BSP/WSP | 03/04/09/10/10B/10BL 14/15/20D/26/32/32D |
| Option | Function | Description | | |
| FM | 7318 | Classroom | | |
| FM | 7324 | Room Door | \$3,711.00 | \$3,735.00 |
| FM | 7325 | Dormitory or Exit | | |
| FM7300 Series Single Non-Keved Cylinder with Deadbolt | | | | |
| Option | Function | Description | | |
| FM | 7301 | Inside Passage | | |
| FM | 7366 | Privacy Bath/Bedroom | \$3,711.00 | \$3,735.00 |
| FM | 7368 | Privacy Bath/Bedroom | | |
| FM7300 Series Double Cylinder with Deadbolt | | | | |
| Option | Function | Description | | |
| FM | 7326 | Store Door | | |
| FM | 7339 | Classroom Security Intruder Deadbolt | | |
| FM | 7340 | Classroom Security Intruder Deadbolt | \$3,711.00 | \$3,735.00 |
| FM | 7341 | Classroom Security Intruder Deadbolt | | |
| FM | 7349 | Security Deadbolt | | |
| FM7300 Electrified Functions | | | | |
| Option | Function | Description | | |
| NAC FM | 73284-12V/-24V | Fail Safe | | |
| NAC FM | 73285-12V/-24V | Fail Secure | \$3,911.00 | \$3,935.00 |
| Notes: Additional Dogging Indicator 188 – Available with all functions. | | | | Add \$515.00 |
| How to order with Dogging Indicator: FM 7326 LNA x 188 x 26D x RH | | | | |

This product is part of a complete tornado assembly and must be used with a Ceco or Curries StormPro door. Concealed vertical rods, top and bottom bolts, and mortise lock body cassette will be factory installed. All other hardware components are shipped directly to the customer and must be installed by a factory trained installer.

MP-16 MULTI-POINT LOCKS

SARGENT®

FM7300 SERIES OPTIONS

ASSA ABLOY

USA & Canada Prices Effective June 3, 2019

| Options | Description | Price |
|---------|---|-----------------|
| 3 | Stainless steel hub | \$63.00 |
| 10 | SARGENT Signature Key System | \$58.00 / cyl. |
| 11† | SARGENT XC Key System (not available w/10, KESO, SC, SE) | No addition |
| 1160 | SARGENT XC Large Format Interchangeable Plastic Disposable Construction Core | No addition |
| 1163 | SARGENT XC Large Format Interchangeable Core Cylinder - Includes masterkeying charges | \$77.00 |
| 1164 | SARGENT XC Large Format Interchangeable Construction Core Cylinder | \$77.00 |
| 1170 | Small Format interchangeable disposable construction core - to accept 7 Pin XC permanent core | No addition |
| 11727P | Small Format interchangeable keyed construction core - to accept 7 Pin XC permanent core | \$69.00 |
| 11737P | Small Format interchangeable core - to accept 7 pin XC permanent core | \$69.00 / cyl. |
| 21† | SARGENT Construction Key System (lost ball) Standard on all new systems established since 5/1/96 | \$16.00 / cyl. |
| 22† | SARGENT Construction Key System (split key) To be used on pre-established split key systems only | \$32.00 / cyl. |
| 36 | 6 Lobe security head screws | \$23.00 |
| 37 | Spanner head screws | \$16.00 |
| 60 | SARGENT Large Format Interchangeable Plastic Disposable Construction Core | No addition |
| 63 | SARGENT Large Format Interchangeable core cylinder, includes master keying charges | \$77.00 / cyl |
| 64 | SARGENT Large Format Interchangeable Construction Core Cylinder | \$77.00 |
| 6573† | Small Format 6-Pin Uncombined Core (Refer to CK-12) | \$59.00 / cyl. |
| 65737P† | Small Format 7-Pin Uncombined Core (Refer to CK-12) | \$59.00 / cyl. |
| 70† | Small Format interchangeable disposable plastic construction core | No addition |
| 72† | Small Format interchangeable 6-Pin construction core | \$69.00 |
| 73† | Small Format interchangeable core 6-pin Includes MK and GMK keying charges | \$69.00 / cyl |
| 737P† | Small Format interchangeable core 7-pin (refer to CK-12 for available keyways) Includes MK and GMK keying charges | \$69.00 / cyl |
| 75 | Tactile Warning - Milled Inside Lever | \$72.00 |
| 76 | Tactile Warning - Milled Outside Lever | \$72.00 |
| 77 | Tactile Warning - Milled Outside and Inside Lever | \$144.00 |
| 81† | Cylinder to accept Keso (83) and Keso F1 (F183) removable core – no core provided | No addition |
| F182† | SARGENT Keso Security Cylinder – patented – new key systems | \$84.00 / cyl. |
| F183† | SARGENT Keso Security Removable Core Cylinder – patented – new key systems | \$120.00 / cyl. |
| 82† | SARGENT Keso Security Cylinder (For existing systems only) | \$84.00 / cyl. |
| 83† | SARGENT Keso Security Removable Core Cylinder (For existing systems only) | \$120.00 / cyl. |
| 84† | SARGENT Keso Security Removable Construction Core Cylinder | See CK-18 |
| 85 | Tactile Warning - Abrasive Coating on Inside Lever | \$45.00 |
| 86 | Tactile Warning - Abrasive Coating on Outside Lever | \$45.00 |
| 87 | Tactile Warning - Abrasive Coating on Outside & Inside Lever | \$90.00 |
| BR | SARGENT Bump Resistant Cylinders (N/A w/10, 22, 30, 60, 63, 64, 70, 72, 73, 737P, KESO, SC, & SE options) | \$23.00/cyl. |
| DX | Deadbolt Monitoring | \$182.00 |
| DG1 | Patented Degree DG1 Key System | No Addition |
| DG160 | Hardware prepared for DG1-6300 Lg. Format IC cores, supplied with temporary plastic construction cores | No addition |
| DG163 | Patented Degree DG1 Large Format Interchangeable Core Cylinder - Includes master keying charges | \$77.00 |
| DG164 | Hardware prepared for DG1-6300 Lg. Format IC cores, supplied with temporary keyed construction cores | \$77.00 |
| DG2 | Patented Degree DG2 Key System incorporating a locking sidebar | \$58.00/cyl. |
| DG260 | Hardware prepared for DG2-6300 Lg. Format IC cores, supplied with temporary plastic construction cores | No addition |
| DG263 | Patented Degree DG2 Large Format Interchangeable Core Cylinder - Includes master keying charges | \$135.00 |
| DG264 | Hardware prepared for DG2-6300 Lg. Format IC cores, supplied with temporary keyed construction cores | \$77.00 |
| DG3 | Patented Degree DG3 Key System incorporating a locking sidebar and UL437 listed | \$82.00/cyl. |
| DG360 | Hardware prepared for DG3-6300 Lg. Format IC cores, supplied with temporary plastic construction cores | No addition |
| DG363 | Patented Degree DG3 Large Format Interchangeable Core Cylinder - Includes master keying charges | \$159.00 |
| DG364 | Hardware prepared for DG3-6300 Lg. Format IC cores, supplied with temporary keyed construction cores | \$77.00 |
| LB | Extra large thumbturn | \$16.00 |
| LC | Less Cylinder | -\$89.00/cyl. |
| SC † | Schlage "C" Keyway cylinder, (Number 41 Cylinder Only, 0 bitted) | No addition |
| SE† | Schlage "E" Keyway cylinder, (Number 41 Cylinder Only, 0 bitted) | No addition |
| SG | MicroShield® – an antimicrobial powder coat finish | \$67.00 |
| T1 | Decorative thumbturn; backplate matches rose design chosen | No Addition |
| T2 | Decorative square thumbturn; backplate matches rose design chosen | No Addition |
| T3 | Decorative cylinder thumbturn; backplate matches rose design chosen | No Addition |
| TL | SARGuide™ – Illuminated escutcheon – refer to catalog for function limitations | \$214.00 |

NOTES: † Not avail. with 60, 63, 64 options

CPC Clear Powder Coat over 26D/32D \$62.00
All orders will continue to be handled as a "special" when CPC is ordered.

USA & Canada Prices Effective June 3, 2019



LE1A
(Handed)

FM7300 SERIES

Standard Escutcheon Designs: LE1, LE2, LE3, LE4, LW1

Standard Lever Designs: A, B, E, F, J, L, P, W

Studio Escutcheon Designs: CE, TE, LE1

Studio Collection Levers Except for Gramercy, Wooster Square, & Grant Park

For Gramercy, Wooster Square, & Grant Park Levers – Add \$138.00 to below prices

Please specify hand when ordering.

Finishes listed below are for ET trim on both sides.
Refer to catalog for available trims, trim finishes and how to order.

| | | | Finish | |
|--|----------------|--------------------------------------|----------------------|---|
| | | | 10BE/26D/ BSP/WSP | 03/04/09/10/10B/10BL 14/15/20D/26/32/32D |
| FM7300 Series Single Cylinder with Deadbolt | | | | |
| Option | Function | Description | | |
| FM | 7318 | Classroom | | |
| FM | 7324 | Room Door | \$3,751.00 | \$3,775.00 |
| FM | 7325 | Dormitory or Exit | | |
| FM7300 Series Single Non-Keyed Cylinder with Deadbolt | | | | |
| Option | Function | Description | | |
| FM | 7301 | Inside Passage | | |
| FM | 7366 | Privacy Bath/Bedroom | \$3,751.00 | \$3,775.00 |
| FM | 7368 | Privacy Bath/Bedroom | | |
| FM7300 Series Double Cylinder with Deadbolt | | | | |
| Option | Function | Description | | |
| FM | 7326 | Store Door | | |
| FM | 7339 | Classroom Security Intruder Deadbolt | | |
| FM | 7340 | Classroom Security Intruder Deadbolt | \$3,751.00 | \$3,775.00 |
| FM | 7341 | Classroom Security Intruder Deadbolt | | |
| FM | 7349 | Security Deadbolt | | |
| FM7300 Electrified Functions | | | | |
| Option | Function | Description | | |
| NAC FM | 73284-12V/-24V | Fail Safe | | |
| NAC FM | 73285-12V/-24V | Fail Secure | \$3,951.00 | \$3,975.00 |

Notes: Additional Dogging Indicator 188 – Available with all functions.
How to order with Dogging Indicator: FM 7326 LE1A x 188 x 26D x RH

Add \$515.00

This product is part of a complete tornado assembly and must be used with a Ceco or Curries StormPro door. Concealed vertical rods, top and bottom bolts, and mortise lock body cassette will be factory installed. All other hardware components are shipped directly to the customer and must be installed by a factory trained installer.

MP-18 MULTI-POINT LOCKS

SARGENT®

FM7300 SERIES OPTIONS

ASSA ABLOY

USA & Canada Prices Effective June 3, 2019

| Options | Description | Price |
|---------|---|-----------------|
| 3 | Stainless steel hub | \$63.00 |
| 10 | SARGENT Signature Key System | \$58.00 / cyl. |
| 11† | SARGENT XC Key System (not available w/10, KESO, SC, SE) | No addition |
| 1160 | SARGENT XC Large Format Interchangeable Plastic Disposable Construction Core | No addition |
| 1163 | SARGENT XC Large Format Interchangeable Core Cylinder - Includes masterkeying charges | \$77.00 |
| 1164 | SARGENT XC Large Format Interchangeable Construction Core Cylinder | \$77.00 |
| 1170 | Small Format interchangeable disposable construction core - to accept 7 Pin XC permanent core | No addition |
| 11727P | Small Format interchangeable keyed construction core - to accept 7 Pin XC permanent core | \$69.00 |
| 11737P | Small Format interchangeable core - to accept 7 pin XC permanent core | \$69.00 / cyl. |
| 21† | SARGENT Construction Key System (lost ball) Standard on all new systems established since 5/1/96 | \$16.00 / cyl. |
| 22† | SARGENT Construction Key System (split key) To be used on pre-established split key systems only | \$32.00 / cyl. |
| 36 | 6 Lobe security head screws | \$23.00 |
| 37 | Spanner head screws | \$16.00 |
| 60 | SARGENT Large Format Interchangeable Plastic Disposable Construction Core | No addition |
| 63 | SARGENT Large Format Interchangeable core cylinder, includes master keying charges | \$77.00 / cyl |
| 64 | SARGENT Large Format Interchangeable Construction Core Cylinder | \$77.00 |
| 6573† | Small Format 6-Pin Uncombined Core (Refer to CK-12) | \$59.00 / cyl. |
| 65737P† | Small Format 7-Pin Uncombined Core (Refer to CK-12) | \$59.00 / cyl. |
| 70† | Small Format interchangeable disposable plastic construction core | No addition |
| 72† | Small Format interchangeable 6-Pin construction core | \$69.00 |
| 73† | Small Format interchangeable core 6-pin Includes MK and GMK keying charges | \$69.00 / cyl |
| 737P† | Small Format interchangeable core 7-pin (refer to CK-12 for available keyways) Includes MK and GMK keying charges | \$69.00 / cyl |
| 75 | Tactile Warning - Milled Inside Lever | \$72.00 |
| 76 | Tactile Warning - Milled Outside Lever | \$72.00 |
| 77 | Tactile Warning - Milled Outside and Inside Lever | \$144.00 |
| 81† | Cylinder to accept Keso (83) and Keso F1 (F183) removable core – no core provided | No addition |
| F182† | SARGENT Keso Security Cylinder – patented – new key systems | \$84.00 / cyl. |
| F183† | SARGENT Keso Security Removable Core Cylinder – patented – new key systems | \$120.00 / cyl. |
| 82† | SARGENT Keso Security Cylinder (For existing systems only) | \$84.00 / cyl. |
| 83† | SARGENT Keso Security Removable Core Cylinder (For existing systems only) | \$120.00 / cyl. |
| 84† | SARGENT Keso Security Removable Construction Core Cylinder | See CK-18 |
| 85 | Tactile Warning - Abrasive Coating on Inside Lever | \$45.00 |
| 86 | Tactile Warning - Abrasive Coating on Outside Lever | \$45.00 |
| 87 | Tactile Warning - Abrasive Coating on Outside & Inside Lever | \$90.00 |
| BR | SARGENT Bump Resistant Cylinders (N/A w/10, 22, 30, 60, 63, 64, 70, 72, 73, 737P, KESO, SC, & SE options) | \$23.00/cyl. |
| DX | Deadbolt Monitoring | \$182.00 |
| DG1 | Patented Degree DG1 Key System | No Addition |
| DG160 | Hardware prepared for DG1-6300 Lg. Format IC cores, supplied with temporary plastic construction cores | No addition |
| DG163 | Patented Degree DG1 Large Format Interchangeable Core Cylinder - Includes master keying charges | \$77.00 |
| DG164 | Hardware prepared for DG1-6300 Lg. Format IC cores, supplied with temporary keyed construction cores | \$77.00 |
| DG2 | Patented Degree DG2 Key System incorporating a locking sidebar | \$58.00/cyl. |
| DG260 | Hardware prepared for DG2-6300 Lg. Format IC cores, supplied with temporary plastic construction cores | No addition |
| DG263 | Patented Degree DG2 Large Format Interchangeable Core Cylinder - Includes master keying charges | \$135.00 |
| DG264 | Hardware prepared for DG2-6300 Lg. Format IC cores, supplied with temporary keyed construction cores | \$77.00 |
| DG3 | Patented Degree DG3 Key System incorporating a locking sidebar and UL437 listed | \$82.00/cyl. |
| DG360 | Hardware prepared for DG3-6300 Lg. Format IC cores, supplied with temporary plastic construction cores | No addition |
| DG363 | Patented Degree DG3 Large Format Interchangeable Core Cylinder - Includes master keying charges | \$159.00 |
| DG364 | Hardware prepared for DG3-6300 Lg. Format IC cores, supplied with temporary keyed construction cores | \$77.00 |
| LB | Extra large thumbturn | \$16.00 |
| LC | Less Cylinder | -\$89.00/cyl. |
| SC▲† | Schlage "C" Keyway cylinder, (Number 41 Cylinder Only, 0 bitted) | No addition |
| SE▲† | Schlage "E" Keyway cylinder, (Number 41 Cylinder Only, 0 bitted) | No addition |
| SG | MicroShield® – an antimicrobial powder coat finish | \$67.00 |
| T1 | Decorative thumbturn; backplate matches rose design chosen | No Addition |
| T2 | Decorative square thumbturn; backplate matches rose design chosen | No Addition |
| T3 | Decorative cylinder thumbturn; backplate matches rose design chosen | No Addition |
| TL | SARGuide™ – Illuminated escutcheon – refer to catalog for function limitations | \$214.00 |

NOTES: † Not avail. with 60, 63, 64 options

CPC Clear Powder Coat over 26D/32D \$62.00
All orders will continue to be handled as a "special" when CPC is ordered.

USA & Canada Prices Effective June 3, 2019



LS

FM7300 SERIES
Escutcheon Design: LS
Standard Lever Designs: A, B, E, F, J, L, P, W

Please specify hand when ordering.

Finishes listed below are for ET trim on both sides.
 Refer to catalog for available trims, trim finishes and how to order.

| | | | Finish | |
|--|----------------|--------------------------------------|----------------------|---|
| | | | 10BE/26D/ BSP/WSP | 03/04/09/10/10B/10BL 14/15/20D/26/32/32D |
| FM7300 Series Single Cylinder with Deadbolt | | | | |
| Option | Function | Description | | |
| FM | 7318 | Classroom | | |
| FM | 7324 | Room Door | \$4,211.00 | \$4,235.00 |
| FM | 7325 | Dormitory or Exit | | |
| FM7300 Series Single Non-Keyed Cylinder with Deadbolt | | | | |
| Option | Function | Description | | |
| FM | 7301 | Inside Passage | | |
| FM | 7366 | Privacy Bath/Bedroom | \$4,211.00 | \$4,235.00 |
| FM | 7368 | Privacy Bath/Bedroom | | |
| FM7300 Series Double Cylinder with Deadbolt | | | | |
| Option | Function | Description | | |
| FM | 7326 | Store Door | | |
| FM | 7339 | Classroom Security Intruder Deadbolt | | |
| FM | 7340 | Classroom Security Intruder Deadbolt | \$4,211.00 | \$4,235.00 |
| FM | 7341 | Classroom Security Intruder Deadbolt | | |
| FM | 7349 | Security Deadbolt | | |
| FM7300 Electrified Functions | | | | |
| Option | Function | Description | | |
| NAC FM | 73284-12V/-24V | Fail Safe | | |
| NAC FM | 73285-12V/-24V | Fail Secure | \$4,411.00 | \$4,435.00 |

Notes: Additional Dogging Indicator 188 – Available with all functions.

Add \$515.00

How to order with Dogging Indicator: FM 7326 LSA x 188 x 26D x RH

This product is part of a complete tornado assembly and must be used with a Ceco or Curries StormPro door. Concealed vertical rods, top and bottom bolts, and mortise lock body cassette will be factory installed. All other hardware components are shipped directly to the customer and must be installed by a factory trained installer.

MP-20 MULTI-POINT LOCKS

SARGENT®

FM7300 SERIES OPTIONS

ASSA ABLOY

USA & Canada Prices Effective June 3, 2019

| Options | Description | Price |
|---------|---|-----------------|
| 3 | Stainless steel hub | \$63.00 |
| 10 | SARGENT Signature Key System | \$58.00 / cyl. |
| 11† | SARGENT XC Key System (not available w/10, KESO, SC, SE) | No addition |
| 1160 | SARGENT XC Large Format Interchangeable Plastic Disposable Construction Core | No addition |
| 1163 | SARGENT XC Large Format Interchangeable Core Cylinder - Includes masterkeying charges | \$77.00 |
| 1164 | SARGENT XC Large Format Interchangeable Construction Core Cylinder | \$77.00 |
| 1170 | Small Format interchangeable disposable construction core - to accept 7 Pin XC permanent core | No addition |
| 11727P | Small Format interchangeable keyed construction core - to accept 7 Pin XC permanent core | \$69.00 |
| 11737P | Small Format interchangeable core - to accept 7 pin XC permanent core | \$69.00 / cyl. |
| 21† | SARGENT Construction Key System (lost ball) Standard on all new systems established since 5/1/96 | \$16.00 / cyl. |
| 22† | SARGENT Construction Key System (split key) To be used on pre-established split key systems only | \$32.00 / cyl. |
| 36 | 6 Lobe security head screws | \$23.00 |
| 37 | Spanner head screws | \$16.00 |
| 60 | SARGENT Large Format Interchangeable Plastic Disposable Construction Core | No addition |
| 63 | SARGENT Large Format Interchangeable core cylinder, includes master keying charges | \$77.00 / cyl |
| 64 | SARGENT Large Format Interchangeable Construction Core Cylinder | \$77.00 |
| 6573† | Small Format 6-Pin Uncombined Core (Refer to CK-12) | \$59.00 / cyl. |
| 65737P† | Small Format 7-Pin Uncombined Core (Refer to CK-12) | \$59.00 / cyl. |
| 70† | Small Format interchangeable disposable plastic construction core | No addition |
| 72† | Small Format interchangeable 6-Pin construction core | \$69.00 |
| 73† | Small Format interchangeable core 6-pin Includes MK and GMK keying charges | \$69.00 / cyl |
| 737P† | Small Format interchangeable core 7-pin (refer to CK-12 for available keyways) Includes MK and GMK keying charges | \$69.00 / cyl |
| 75 | Tactile Warning - Milled Inside Lever | \$72.00 |
| 76 | Tactile Warning - Milled Outside Lever | \$72.00 |
| 77 | Tactile Warning - Milled Outside and Inside Lever | \$144.00 |
| 81▲† | Cylinder to accept Keso (83) and Keso F1 (F183) removable core – no core provided | No addition |
| F182† | SARGENT Keso Security Cylinder – patented – new key systems | \$84.00 / cyl. |
| F183▲† | SARGENT Keso Security Removable Core Cylinder – patented – new key systems | \$120.00 / cyl. |
| 82† | SARGENT Keso Security Cylinder (For existing systems only) | \$84.00 / cyl. |
| 83▲† | SARGENT Keso Security Removable Core Cylinder (For existing systems only) | \$120.00 / cyl. |
| 84▲† | SARGENT Keso Security Removable Construction Core Cylinder | See CK-18 |
| 85 | Tactile Warning - Abrasive Coating on Inside Lever | \$45.00 |
| 86 | Tactile Warning - Abrasive Coating on Outside Lever | \$45.00 |
| 87 | Tactile Warning - Abrasive Coating on Outside & Inside Lever | \$90.00 |
| BR | SARGENT Bump Resistant Cylinders (N/A w/10, 22, 30, 60, 63, 64, 70, 72, 73, 737P, KESO, SC, & SE options) | \$23.00/cyl. |
| DX | Deadbolt Monitoring | \$182.00 |
| DG1 | Patented Degree DG1 Key System | No Addition |
| DG160 | Hardware prepared for DG1-6300 Lg. Format IC cores, supplied with temporary plastic construction cores | No addition |
| DG163 | Patented Degree DG1 Large Format Interchangeable Core Cylinder - Includes master keying charges | \$77.00 |
| DG164 | Hardware prepared for DG1-6300 Lg. Format IC cores, supplied with temporary keyed construction cores | \$77.00 |
| DG2 | Patented Degree DG2 Key System incorporating a locking sidebar | \$58.00/cyl. |
| DG260 | Hardware prepared for DG2-6300 Lg. Format IC cores, supplied with temporary plastic construction cores | No addition |
| DG263 | Patented Degree DG2 Large Format Interchangeable Core Cylinder - Includes master keying charges | \$135.00 |
| DG264 | Hardware prepared for DG2-6300 Lg. Format IC cores, supplied with temporary keyed construction cores | \$77.00 |
| DG3 | Patented Degree DG3 Key System incorporating a locking sidebar and UL437 listed | \$82.00/cyl. |
| DG360 | Hardware prepared for DG3-6300 Lg. Format IC cores, supplied with temporary plastic construction cores | No addition |
| DG363 | Patented Degree DG3 Large Format Interchangeable Core Cylinder - Includes master keying charges | \$159.00 |
| DG364 | Hardware prepared for DG3-6300 Lg. Format IC cores, supplied with temporary keyed construction cores | \$77.00 |
| LB | Extra large thumbturn | \$16.00 |
| LC | Less Cylinder | -\$89.00/cyl. |
| SC▲† | Schlage "C" Keyway cylinder, (Number 41 Cylinder Only, 0 bitted) | No addition |
| SE▲† | Schlage "E" Keyway cylinder, (Number 41 Cylinder Only, 0 bitted) | No addition |
| SG | MicroShield® – an antimicrobial powder coat finish | \$67.00 |
| T1 | Decorative thumbturn; backplate matches rose design chosen | No Addition |
| T2 | Decorative square thumbturn; backplate matches rose design chosen | No Addition |
| T3 | Decorative cylinder thumbturn; backplate matches rose design chosen | No Addition |
| TL | SARGuide™ – Illuminated escutcheon – refer to catalog for function limitations | \$214.00 |

NOTES: † Not avail. with 60, 63, 64 options

CPC Clear Powder Coat over 26D/32D \$62.00
All orders will continue to be handled as a "special" when CPC is ordered.

USA & Canada Prices Effective June 3, 2019



FM7300 SERIES
Escutcheon Design: WT
Standard Lever Designs: A, B, E, F, J, L, P, W

WTA

Please specify hand when ordering.

Finishes listed below are for ET trim on both sides.
Refer to catalog for available trims, trim finishes and how to order.

| | | | Finish | |
|--|----------------|--------------------------------------|----------------------|---|
| | | | 10BE/26D/ BSP/WSP | 03/04/09/10/10B/10BL 14/15/20D/26/32/32D |
| FM7300 Series Single Cylinder with Deadbolt | | | | |
| Option | Function | Description | | |
| FM | 7318 | Classroom | | |
| FM | 7324 | Room Door | \$3,661.00 | \$3,685.00 |
| FM | 7325 | Dormitory or Exit | | |
| FM7300 Series Single Non-Keyed Cylinder with Deadbolt | | | | |
| Option | Function | Description | | |
| FM | 7301 | Inside Passage | | |
| FM | 7366 | Privacy Bath/Bedroom | \$3,661.00 | \$3,685.00 |
| FM | 7368 | Privacy Bath/Bedroom | | |
| FM7300 Series Double Cylinder with Deadbolt | | | | |
| Option | Function | Description | | |
| FM | 7326 | Store Door | | |
| FM | 7339 | Classroom Security Intruder Deadbolt | | |
| FM | 7340 | Classroom Security Intruder Deadbolt | \$3,661.00 | \$3,685.00 |
| FM | 7341 | Classroom Security Intruder Deadbolt | | |
| FM | 7349 | Security Deadbolt | | |
| FM7300 Electrified Functions | | | | |
| Option | Function | Description | | |
| NAC FM | 73284-12V/-24V | Fail Safe | | |
| NAC FM | 73285-12V/-24V | Fail Secure | \$3,861.00 | \$3,885.00 |

Notes: Additional Dogging Indicator 188 – Available with all functions.
How to order with Dogging Indicator: FM 7326 WTA x 188 x 26D x RH

Add \$515.00

This product is part of a complete tornado assembly and must be used with a Ceco or Curries StormPro door. Concealed vertical rods, top and bottom bolts, and mortise lock body cassette will be factory installed. All other hardware components are shipped directly to the customer and must be installed by a factory trained installer.

MP-22 MULTI-POINT LOCKS

SARGENT®

FM7300 SERIES FREEWHEELING OPTIONS

ASSA ABLOY

USA & Canada Prices Effective June 3, 2019

| Options | Description | Price |
|---------|---|-----------------|
| 3 | Stainless steel hub | \$63.00 |
| 10 | SARGENT Signature Key System | \$58.00 / cyl. |
| 11† | SARGENT XC Key System (not available w/10, KESO, SC, SE) | No addition |
| 1160 | SARGENT XC Large Format Interchangeable Plastic Disposable Construction Core | No addition |
| 1163 | SARGENT XC Large Format Interchangeable Core Cylinder - Includes masterkeying charges | \$77.00 |
| 1164 | SARGENT XC Large Format Interchangeable Construction Core Cylinder | \$77.00 |
| 1170 | Small Format interchangeable disposable construction core - to accept 7 Pin XC permanent core | No addition |
| 11727P | Small Format interchangeable keyed construction core - to accept 7 Pin XC permanent core | \$69.00 |
| 11737P | Small Format interchangeable core - to accept 7 pin XC permanent core | \$69.00 / cyl. |
| 21† | SARGENT Construction Key System (lost ball) Standard on all new systems established since 5/1/96 | \$16.00 / cyl. |
| 22† | SARGENT Construction Key System (split key) To be used on pre-established split key systems only | \$32.00 / cyl. |
| 36 | 6 Lobe security head screws | \$23.00 |
| 37 | Spanner head screws | \$16.00 |
| 60 | SARGENT Large Format Interchangeable Plastic Disposable Construction Core | No addition |
| 63 | SARGENT Large Format Interchangeable core cylinder, includes master keying charges | \$77.00 / cyl |
| 64 | SARGENT Large Format Interchangeable Construction Core Cylinder | \$77.00 |
| 6573† | Small Format 6-Pin Uncombined Core (Refer to CK-12) | \$59.00 / cyl. |
| 65737P† | Small Format 7-Pin Uncombined Core (Refer to CK-12) | \$59.00 / cyl. |
| 70† | Small Format interchangeable disposable plastic construction core | No addition |
| 72† | Small Format interchangeable 6-Pin construction core | \$69.00 |
| 73† | Small Format interchangeable core 6-pin Includes MK and GMK keying charges | \$69.00 / cyl |
| 737P† | Small Format interchangeable core 7-pin (refer to CK-12 for available keyways) Includes MK and GMK keying charges | \$69.00 / cyl |
| 75 | Tactile Warning - Milled Inside Lever | \$72.00 |
| 76 | Tactile Warning - Milled Outside Lever | \$72.00 |
| 77 | Tactile Warning - Milled Outside and Inside Lever | \$144.00 |
| 81† | Cylinder to accept Keso (83) and Keso F1 (F183) removable core – no core provided | No addition |
| F182† | SARGENT Keso Security Cylinder – patented – new key systems | \$84.00 / cyl. |
| F183† | SARGENT Keso Security Removable Core Cylinder – patented – new key systems | \$120.00 / cyl. |
| 82† | SARGENT Keso Security Cylinder (For existing systems only) | \$84.00 / cyl. |
| 83▲† | SARGENT Keso Security Removable Core Cylinder (For existing systems only) | \$120.00 / cyl. |
| 84▲† | SARGENT Keso Security Removable Construction Core Cylinder | See CK-18 |
| 85 | Tactile Warning - Abrasive Coating on Inside Lever | \$45.00 |
| 86 | Tactile Warning - Abrasive Coating on Outside Lever | \$45.00 |
| 87 | Tactile Warning - Abrasive Coating on Outside & Inside Lever | \$90.00 |
| BR | SARGENT Bump Resistant Cylinders (N/A w/10, 22, 30, 60, 63, 64, 70, 72, 73, 737P, KESO, SC, & SE options) | \$23.00/cyl. |
| DX | Deadbolt Monitoring | \$182.00 |
| DG1 | Patented Degree DG1 Key System | No Addition |
| DG160 | Hardware prepared for DG1-6300 Lg. Format IC cores, supplied with temporary plastic construction cores | No addition |
| DG163 | Patented Degree DG1 Large Format Interchangeable Core Cylinder - Includes master keying charges | \$77.00 |
| DG164 | Hardware prepared for DG1-6300 Lg. Format IC cores, supplied with temporary keyed construction cores | \$77.00 |
| DG2 | Patented Degree DG2 Key System incorporating a locking sidebar | \$58.00/cyl. |
| DG260 | Hardware prepared for DG2-6300 Lg. Format IC cores, supplied with temporary plastic construction cores | No addition |
| DG263 | Patented Degree DG2 Large Format Interchangeable Core Cylinder - Includes master keying charges | \$135.00 |
| DG264 | Hardware prepared for DG2-6300 Lg. Format IC cores, supplied with temporary keyed construction cores | \$77.00 |
| DG3 | Patented Degree DG3 Key System incorporating a locking sidebar and UL437 listed | \$82.00/cyl. |
| DG360 | Hardware prepared for DG3-6300 Lg. Format IC cores, supplied with temporary plastic construction cores | No addition |
| DG363 | Patented Degree DG3 Large Format Interchangeable Core Cylinder - Includes master keying charges | \$159.00 |
| DG364 | Hardware prepared for DG3-6300 Lg. Format IC cores, supplied with temporary keyed construction cores | \$77.00 |
| LB | Extra large thumbturn | \$16.00 |
| LC | Less Cylinder | -\$89.00/cyl. |
| SC▲† | Schlage "C" Keyway cylinder, (Number 41 Cylinder Only, 0 bitted) | No addition |
| SE▲† | Schlage "E" Keyway cylinder, (Number 41 Cylinder Only, 0 bitted) | No addition |
| SG | MicroShield® – an antimicrobial powder coat finish | \$67.00 |
| T1 | Decorative thumbturn; backplate matches rose design chosen | No Addition |
| T2 | Decorative square thumbturn; backplate matches rose design chosen | No Addition |
| T3 | Decorative cylinder thumbturn; backplate matches rose design chosen | No Addition |
| TL | SARGuide™ – Illuminated escutcheon – refer to catalog for function limitations | \$214.00 |

NOTES: † Not avail. with 60, 63, 64 options

CPC Clear Powder Coat over 26D/32D \$62.00
All orders will continue to be handled as a "special" when CPC is ordered.

USA & Canada Prices Effective June 3, 2019



FEL

FM7300 SERIES
Escutcheon Design: FE
Standard Lever Designs: A, B, E, F, J, L, P, W

Please specify hand when ordering.

Finishes listed below are for ET trim on both sides.
 Refer to catalog for available trims, trim finishes and how to order.

| FM7300 Series Freewheeling | | | Finish | |
|--|-----------------|--------------------------------------|------------------------------|---|
| FM7300 Series Single Cylinder with Deadbolt | | | 10BE/26D/ BSP/WSP | 03/04/09/10/10B/10BL 14/15/20D/26/32/32D |
| Option | Function | Description | | |
| FM | 7324 | Room Door | | |
| FM | 7325 | Dormitory or Exit | \$3,831.00 | \$3,855.00 |
| FM7300 Series Single Non-Keyed Cylinder with Deadbolt | | | | |
| Option | Function | Description | | |
| FM | 7366 | Privacy Bath/Bedroom | \$3,831.00 | \$3,855.00 |
| FM7300 Series Double Cylinder with Deadbolt | | | | |
| Option | Function | Description | | |
| FM | 7326 | Store Door | | |
| FM | 7339 | Classroom Security Intruder Deadbolt | \$3,831.00 | \$3,855.00 |
| FM | 7340 | Classroom Security Intruder Deadbolt | | |

Notes: Additional Dogging Indicator 188 – Available with all functions.
How to order with Dogging Indicator: FM 7326 FEL x 188 x 26D x RH

Add \$515.00

This product is part of a complete tornado assembly and must be used with a Ceco or Curries StormPro door. Concealed vertical rods, top and bottom bolts, and mortise lock body cassette will be factory installed. All other hardware components are shipped directly to the customer and must be installed by a factory trained installer.

DOOR CLOSERS

| | |
|---|------|
| How to Order/ANSI Finish & Function Comparison..... | DC-1 |
| Additional Features | DC-2 |
| 281/351/1431 Series | DC-3 |
| 351 Pocket Closer/268, 269, 281 Security Package Closer/ 422 Cam Action Door Closer/268, 269, 278 Concealed Closers | DC-4 |
| Finish Options | DC-5 |
| Arms, Accessories..... | DC-6 |
| Bodies & Covers | DC-7 |
| 1331 & 1131 Series..... | DC-8 |

Parts

| | |
|----------------------------------|-------|
| Parts 01-0134 thru 63-3837 | DC-9 |
| Parts 63-3839 thru 64-2409 | DC-10 |

HOLDERS & STOPS

| | |
|---|------|
| 590, 690, 1530, 1540 Series and Accessories | HS-1 |
| 1560 Electromagnetic Door Holder..... | HS-2 |

How To Order

| Step | Description | Example |
|---------------|--|-------------------------------|
| Quantity | Each | 20 Ea. |
| Series | 351, 268, 269, 278, 281, 422, 1431, 1131 | 20 Ea.- 281 |
| Arm | Consult proper section for arms available | 20 Ea.- 281-P10 |
| Finish | Consult proper section for finishes available | 20 Ea.- 281-P10-EB |
| Hand | Consult proper section to determine if handing is required | 20 Ea.- 281-P10-EB |
| Option | Consult proper section for options available | 20 Ea.- SR -281-P10-EB |
| Miscellaneous | Overhead holder template number | Template number _____ |

ANSI Finish and Function Comparison

| Function | | Finish | | |
|----------|--------|---------|------|--|
| SARGENT | ANSI | SARGENT | ANSI | Description |
| Arm Type | | EN | 689 | Aluminum Powder Coat |
| O | CO2011 | EB | 695 | Bronze Powder Coat to match 10B |
| P9 | CO2021 | ED | 693 | Black Powder Coat to match 20D |
| H | CO2051 | EP | 691 | Bronze Powder Coat to match 10 |
| PH9 | CO2061 | EAB | 696 | Brass Powder Coat to be used with Brass finishes |
| F | CO2091 | 3 | 605 | Bright Brass, Clear Coated Polished Brass |
| PF9 | CO2101 | 4 | 606 | Satin Brass, Clear Coated Dull Brass |
| O | CO2041 | 9 | 637 | Bright Bronze, Clear Coated |
| H | CO2081 | 10 | 612 | Satin Bronze, Clear Coated Dull Bronze |
| F | CO2121 | 10B | 613 | Dark Oxidized Dull Bronze, Oil Rubbed |
| 268-O | CO5031 | 10BE | 613E | Dark Oxidized Satin Bronze - Equivalent |
| 269-O | CO5041 | 15 | 619 | Dull Nickel with Clear Coat |
| 278-H | CO5091 | 20D | – | Statuary Dark Bronze with Clear Coat |
| 278-O | CO5011 | 26 | 625 | Bright Chromium Plated Polished Chrome |
| 278-F | CO5101 | 26D | 626 | Satin Chromium Plated Dull Chrome |
| | | 10BL | – | Oxidized Dull Bronze with Clear Coat |
| | | BSP | – | Black Suede Powder Coat |
| | | WSP | – | White Suede Powder Coat |

NOTES:

- 351, 268, 269, 278, 281, 422, 1431, 1331 and 1131 Series Closers are ANSI/BHMA A156.4 – 2000 Grade 1 certified
- 351, 268, 269, 278, 281, 422, 1431 and 1331 Series Closers are UL10C listed for positive pressure fire test
- 351, 281 and 1431 Series closers are certified for above ANSI functions including PT4 options A, B, D, E, F, G, H
- 1131, 1331 Series closers are certified for above ANSI functions including PT4 options A, B, C, D, H

DC-2 DOOR CLOSERS

SARGENT®

ASSA ABLOY

ADDITIONAL FEATURES

USA & Canada Prices Effective June 3, 2019

| Additional Features with Door Closers | | |
|--|---|--------------------|
| Options | Description | Price |
| ABC | Advanced Backcheck: 281 Series only | \$30.00 |
| DA | Delayed Action: 351, 281, 268, 269, 1431 Series | \$38.00 |
| EC | Environmentally friendly ABS plastic cover (281 Series only) | \$5.00 |
| LDP | Retrofit Plate | \$103.00 |
| MC* | Closer w/Metal cover - Handed, indicate RH or LH Cover includes SRI as standard - EB, ED, EN, EP, EAB To order covers separately, refer to DC-7 | \$16.00 |
| SRI* | Corrosion Protection - Additional Special Rust Inhibitor: 351, 422, 1431 Series - Not available w/plated finishes - Arm Only 268, 269, 278, 281 Series - Not available w/plated finishes - Arm & Body | \$36.00 \$42.00 |
| 36* | 6-Lobe screws (Security Torx-Machine screws only) | \$24.00 |
| TB | Mortise Nuts for use with machine screws, supplied with closer (not available with 268 & 269 series) | \$6.00 |
| WD | Wood screws for wood door application | No Addition |
| | Factory sizing upon request - specify size | No Addition |

*Options available with 281, 351, 422, & 1431 Series

Standard Features:

| | |
|--|-------------|
| Backcheck: 351, 281, 422, 1431 Series - Standard | No Addition |
| Pressure Relief Valves: 268, 281, 422, 278, 1431 Series - Standard | No Addition |
| Extreme Temperature Fluid: 268, 278, 281, 422, 351, 1431 Series - Standard | No Addition |

Installation Aids/Miscellaneous Parts

| Part # | Description | Price |
|---------------|---|----------------|
| 4TB | Mortise Nuts ordered separate – used w/Machine Screws (provided w/every closer) (4 per set) | \$14.00 /Set |
| 82-3855 | Torx Bit Kit (Sizes T8, T9, T10, T15, T20, T25, T27) | \$155.00 /each |
| 82-3856 | Spanner Bit Kit (Sizes 4, 6, 8, 10, 12, 1/4") | \$120.87 /each |
| 63-0694 | Hex Wrench, for indexing and adjusting PH10 arms | \$5.69 /each |

Notes: Lead Line Covers available with 351, 281, 422 and 1431 closers
How to Order: 351 x EN x Lead Line Cover
Orders will be handled as "special" – Discounts do not apply.

Add \$165.00



| <u>Surface Closer</u> | | 10BE/EB/ED/EN/EP/EAB/BSP/WSP Finishes | | |
|--|--------------------------|---------------------------------------|----------|----------|
| Application | | 1431 | 281 | 351 |
| Wrought Standard Arm | RO | \$456.00 | NA | NA |
| Wrought Parallel Arm | RP9 | \$456.00 | NA | NA |
| Wrought Universal Arm | RUO | \$463.00 | NA | NA |
| Standard Arm | O, OLC, O8, OZ, OZA | \$470.00 | \$568.00 | \$549.00 |
| Standard Arm - Pocket | OP | NA | NA | \$549.00 |
| Parallel Arm | P3**, P3A, P4**, P4A, P9 | \$470.00 | \$568.00 | \$549.00 |
| Standard Heavy Duty Arm (fits 281 only) | O10 | NA | \$607.00 | NA |
| Parallel Heavy Duty Arm | P10 | \$509.00 | \$607.00 | \$588.00 |
| Parallel Heavy Duty Drop Arm | PD10 | NA | \$607.00 | \$588.00 |
| Universal Arm | UO | \$475.00 | \$573.00 | \$554.00 |
| Holder Arm | H, H8*, HZ, HZA | \$530.00 | \$628.00 | \$609.00 |
| Parallel Holder Arm | PH4, PH9 | \$530.00 | \$628.00 | \$609.00 |
| Universal Holder Arm | UH | \$530.00 | \$628.00 | \$609.00 |
| Parallel Holder Heavy Duty Arm | PH10* | \$547.00 | \$645.00 | \$626.00 |
| Standard Holder Heavy Duty Arm | H10 | NA | \$645.00 | NA |
| Parallel Stop Heavy Duty Arm | PS | \$541.00 | \$639.00 | \$620.00 |
| Compression Stop Heavy Duty Arm | CPS | \$661.00 | \$759.00 | \$740.00 |
| Parallel Stop/Holder Heavy Duty Arm | PSH | \$604.00 | \$702.00 | \$683.00 |
| Compression Holder Heavy Duty Arm | CPSH | \$722.00 | \$820.00 | \$801.00 |
| Track Arm | OT, POT | \$529.00 | \$627.00 | \$608.00 |
| Track Arm - Pocket Arm | OTP | NA | NA | \$608.00 |
| Track Holder Arm | HT, PHT | \$557.00 | \$655.00 | \$636.00 |
| Track Bumper Arm | OTB, POTB | \$561.00 | \$659.00 | \$640.00 |
| Track Holder Bumper Arm | HTB, PHTB | \$581.00 | \$679.00 | \$660.00 |
| Track Double Egress Single Step Frame | ODS | NA | NA | \$731.00 |
| Track Double Egress Single Step Frame w/Bumper | ODSB | NA | NA | \$746.00 |
| Track Double Egress Single Step Frame w/Holder | HDS | NA | NA | \$824.00 |
| Track Double Egress Single Step Frame w/Holder | HDSB | NA | NA | \$845.00 |
| Track Double Egress | OD | \$607.00 | \$705.00 | \$686.00 |
| Track Double Egress w/Bumper | ODB | \$621.00 | \$719.00 | \$700.00 |
| Track Double Egress w/Holder | HD | \$701.00 | \$799.00 | \$780.00 |
| Track Double Egress w/Holder & Bumper | HDB | \$720.00 | \$818.00 | \$799.00 |

NOTES

* Please specify hand when ordering.

** Furnished standard with installation data sheet for use with #590 overhead holder. Please indicate on order if alternate data sheet is required.

DC-4 DOOR CLOSERS

SARGENT®

SPECIALTY CLOSERS

ASSA ABLOY

USA & Canada Prices Effective June 3, 2019

| <u>Concealed Closer</u> | | | 10BE/EB/ED/EN/EP/EAB/BSP/WSP |
|-------------------------|-----|--|------------------------------|
| Closer Series | Arm | Arm Type - Handed - specify hand when ordering | Price |
| 268 | O | Concealed Track Arm | \$747.00 |
| 268 | OB | Concealed Track Arm w/Bumper | \$787.00 |
| 268 | H | Concealed Track Holder Arm | \$778.00 |
| 268 | HB | Concealed Track Holder Arm w/Bumper | \$826.00 |
| 269 | O | Concealed Track Arm | \$823.00 |
| 269 | OB | Concealed Track Arm w/Bumper | \$864.00 |
| 278 | OE | Exposed Standard Arm | \$633.00 |
| 278 | H | Exposed Holder Arm | \$678.00 |

How to order - Example: 268 O EN RH

| <u>Security Package Closers – Complete Closer Package</u> | | | 10BE/EB/ED/EN/EP/EAB/BSP/WSP |
|---|-------|--|------------------------------|
| Closer Series | Arm | Arm Type - Handed - specify hand when ordering | Price |
| 268 | CSP | Concealed with Track | \$900.00 |
| 268 | CSPS | Single pole double throw door position switch | \$992.00 |
| 268 | CSPD | Double pole double throw door position switch | \$1,006.00 |
| 269 | CSP | Concealed with Track | \$1,004.00 |
| 269 | CSPS | Single pole double throw door position switch | \$1,123.00 |
| 269 | CSPD | Double pole double throw door position switch | \$1,140.00 |
| 281 | SSP | Parallel Arm, heavy duty | \$726.00 |
| 281 | SSO | Standard Arm, heavy duty | \$726.00 |
| 281 | SSPT | Track - pull side | \$791.00 |
| 281 | PSSPT | Track - push side | \$791.00 |

Note: The Security Package on the 281, 268 and 269 Door Closer Series consists of the door closer body, the handed metal cover or steel top plate, security closer arm or security track, and 6-Lobe security torx screws.

How to order - Example: 281 SSP EN RH

| <u>422 Cam Action Closer</u> | | | 10BE/EB/ED/EN/EP/EAB/BSP/WSP |
|------------------------------|--------|-----------------------------------|------------------------------|
| Closer Series | Arm | Arm Type | Price |
| 422 | CTB2 | Pull Side, Non-Hold Open | \$577.00 |
| 422 | CTHB2 | Pull Side, Hold Open | \$604.00 |
| 422 | PCTB2 | Push Side, Non-Hold Open (Handed) | \$577.00 |
| 422 | PCHTB2 | Push Side, Hold Open (Handed) | \$604.00 |

How to order - Example: 422 PCTB2 EN RH

USA & Canada Prices Effective June 3, 2019

| <u>Finish Options with Door Closers</u> | <u>Finish</u> |
|--|---|
| 1431, 268, 269, 278, 281, 422, 351 Series Closers | 03/04/09/10/10B/ 10BL/14/15/20D/26/26D |
| Description | |
| Cover and arm 1, 2 | Add \$535.00 |
| Cover only 1 | \$218.00 |
| Arm only 1, 2 | \$317.00 |
| Finish Plate (268, 269, 278 Series) 04, 10B, 26D only | \$191.00 |
| Brackets and Mounting Plates – Ordered Separately | \$98.00 |
| Custom powder coat 1, 3 | (Provide sample to factory for available colors and price.) |
| Set-up charge per color 1, 3 | \$195.00 per order/per color |
| <hr/> | |
| Spray paint to match SARGENT standard colors (12 cans per case, all one color) | \$432.00 p/case |

Notes

1. Closers/Cover

- A. All plated closers are supplied with metal covers which are handed. Specify RH or LH for handing.
- B. SRI (rust inhibiting process) not available with plated finishes
- C. For items or finishes not listed, consult factory for availability and pricing.
- D. Addition for metal cover is included in the plating charges.

2. Arms

- A. UO, UH, RO, RP9, RUO, Track arms and link arms are not available in plated finishes.
- B. Order O or H for standard applications and as P9 or PH9 for parallel arm applications.

3. Custom Powder Coat

- A. Handed metal covers must be used for powder coat finishes. Please indicate RH or LH.
- B. Addition for metal cover is included in the powder coat charges.
- C. The factory must be supplied with a color sample to match.
- D. All powder coat finish must be approved by the factory prior to ordering.

How to Order Plated Closers

Please note what finish option is required, if not spelled out plated cover only will be shipped.

Ex: 1 ea. 351 O x 03 x RH – Cover and Arm will be plated US3

1 ea. 351MC O x 03 x LH – Cover will be plated US3, Arm will be painted EAB

Special Finish Options

| | | |
|--|---|--------------------|
| CPC | Clear Powder Coat over 26D – How to order: 351 x O x 26D x CPC | Add \$148.00 |
| MPC | Bright Metallic Powder Coat finish – How to Order: 35 x O x MPC | \$67.00 |
| MPC | MPC Set-up charge – Discounts do not apply. | \$130.00 per order |
| A set-up fee will be added to EACH purchase orders that lists non-standard sprayed or powder coat finishes. | | \$800.00 |
| Discount 50% only. Fee will appear as a separate line item on invoice: SETUPDCG | | |

Notes: All CPC and MPC orders will be handled as a special.

DC-6 DOOR CLOSERS

SARGENT®

ACCESSORIES

ASSA ABLOY

USA & Canada Prices Effective June 3, 2019

| Accessories and Components of Door Closers | | Finishes |
|--|----------------------------|-------------------------------------|
| Description | Part Number | 10BE/EB/ED/EN/EP/EAB/BSP/WSP |
| Corner Bracket | 281W, 1431W | \$111.00 |
| Mounting Plate | 351A, 351B, 281B, 1431B | \$88.00 |
| Drop Plate | 281D, 351D, 1431D | \$88.00 |
| Retrofit Plate | 351L | \$103.00 |
| Flush transom bracket for PS, PSH, P10, CPS, CPSH PH10 Arms | 125VF | \$99.00 |
| Support bracket for PS, PSH, P10, PH10, CPS, CPSH Arms on narrow frame | 125V | \$50.00 |
| Blade stop spacer kit for P9, PH9, PF9 Arms | 581-1 | \$42.00 |
| Blade stop spacer kit for P10, PS, PSH, CPS, CPSH, PH10 Arms | 581-2 | \$70.00 |
| Closer Repair Kit (1431) | 582 | \$59.00 |
| Spacer block for single screw | 63-0191 | \$20.14 (Not finished) |
| Cover Plate | 281J, 281J-2, 1431J | \$58.00 |
| Hold Open Kit – for channel type | 63-3903 | \$47.44 (Not finished) |
| Hold Open Kit w/Bumper – for channel type | 63-3904 | \$74.61 (Not finished) |
| Arms Only 351, 281, 1431 Series (Includes Arm Screw Pack) | | |
| Application | | |
| Standard Wrought Arm (fits 1431 Series only) | 25RO | \$112.00 |
| Parallel Wrought Arm (fits 1431 Series only) | 25RP9 | \$112.00 |
| Wrought Universal Arm (fits 1431 Series only) | 25RUO | \$119.00 |
| Standard Arm | 25O, OLC, O8, OZ, OZA, OP | \$126.00 |
| Parallel Arm | 25P3, P3A, P4, P4A, P9 | \$126.00 |
| Standard Heavy Duty Arm | 25O10 | \$165.00 |
| Parallel Arm Heavy Duty | 25P10 | \$165.00 |
| Parallel Heavy Duty Drop Arm | 25PD10 | \$165.00 |
| Universal Arm | 25UO | \$131.00 |
| Holder Arm (H8-Handed) | 25H, H8, HZ, HZA | \$186.00 |
| Parallel Holder Arm | 25PH4, PH9 | \$186.00 |
| Universal Holder Arm | 25UH | \$192.00 |
| Parallel Holder Heavy Duty Arm (Handed) | 25PH10 | \$203.00 |
| Standard Holder Heavy Duty Arm | 25H10 | \$203.00 |
| Parallel Stop Heavy Duty Arm | 25PS | \$197.00 |
| Compression Stop Heavy Duty Arm | 25CPS | \$317.00 |
| Parallel Stop/Holder Heavy Duty Arm | 25PSH | \$260.00 |
| Compression Holder Heavy Duty Arm | 25CPSH | \$378.00 |
| ▲ Arms supplied at standard 160 degree. Specify suffix (-125) for entry with 125 Degree option | | |
| For example: 25F8-125 x EN x RH | | |
| Complete Track Type Arms Includes Arm and Channel (351, 281, 1431 Series) | | |
| Track Type Arm | 25OT, POT, OTP | \$185.00 |
| Pull Side/Push Side Non-hold Open Arm (Handed) | 25CTB2, PCTB2 (422 Only) | \$301.00 |
| Pull Side/Push Side Hold Open Arm (Handed) | 25CTHB2, PCHTB2 (422 Only) | \$356.00 |
| Track Type Arm/Holder Arm | 25HT, PHT | \$213.00 |
| Track Type Arm | 25OTB, POTB | \$217.00 |
| Track Type Arm/Holder Arm | 25HTB, PHTB | \$237.00 |
| Track Double Egress Single Step Frame Arm *(Handed) | 25ODS | \$308.00 |
| Track Double Egress Single Step Frame w/Bumper Arm *(Handed) | 25ODSB | \$323.00 |
| Track Double Egress Single Step Frame w/Holder Arm *(Handed) | 25HDS | \$401.00 |
| Track Double Egress Single Step Frame w/Holder Arm *(Handed) | 25HDSB | \$422.00 |
| Track Double Egress Arm (Handed) | 25OD | \$263.00 |
| Track Double Egress Arm w/Bumper (Handed) | 25ODB | \$277.00 |
| Track Double Egress Arm w/Holder (Handed) | 25HD | \$357.00 |
| Track Double Egress Arm w/Holder & Bumper (Handed) | 25HDB | \$376.00 |
| Regular arm conversion units- 351, 281, 1431 Series | | |
| Parallel Arm Foot | 125P9, PH9 | \$27.00 |
| Parallel Arm Foot | 125P3, P4, 125PH4 | \$40.00 |
| Parallel Arm Foot | 125P3A, P4A | \$44.00 |
| Inverted Arm Foot | 125OZ, OZA | \$48.00 |

| Components of Door Closers | | |
|---|---------------|--------------------------------------|
| Standard- High Impact Non-Corrosive Cover Non-Handed | | FINISH |
| Closer Series | Part # | 10BE/ EB/ED/EN/EP/EAB/BSP/WSP |
| 351 | 351C | \$41.00 |
| 281 | 281C | \$44.00 |
| 422/1431 | 1431C | \$41.00 |
| Environmentally friendly ABS plastic cover | | |
| 281 | 281CEC | \$49.00 |
| Metal Covers (Handed—specify RH or LH) | | |
| 351 | *351CMC | \$62.00 |
| 281 | *281CMC | \$68.00 |
| 1431/422 | *1431CMC | \$64.00 |

*NOTE: When ordering metal covers only, specify arm type.

| Closer Bodies Only | | |
|-----------------------------|---------------------------------|-------------------------------------|
| Option Closer Series | Closer Series | 10BE/EB/ED/EN/EP/EAB/BSP/WSP |
| CB- 351 | 351 | \$412.00 |
| CB- 281 | 281 | \$422.00 |
| **CB- 278 | 278 | \$479.00 |
| **CB- 268 x Arm Type | 268 – Specify Arm when ordering | \$522.00 |
| **CB- 269 x Arm Type | 269 – Specify Arm when ordering | \$596.00 |
| CB- 1431 | 1431 | \$327.00 |
| CB- 422 | 422 | \$440.00 |

**Handing is required when ordering

DC-8 DOOR CLOSERS

SARGENT®

ASSA ABLOY

1331/1131 SERIES ADJUSTABLE SIZE 1-6

USA & Canada Prices Effective June 3, 2019

| Option | Description | Price |
|-------------------------|--|-----------------|
| EC | Environmentally friendly ABS plastic cover | \$5.00 |
| 1331 Series Door Closer | | Finish |
| Description | Arm | EB/ED/EN/EP/EAB |
| Standard Arm - | 1331 JO | \$393.00 |
| | 1331 JOZ | \$393.00 |
| | 1331 JP9 | \$393.00 |
| | 1331 JP10 | \$422.00 |
| | 1331 JUO | \$399.00 |
| | 1331 JPS | \$463.00 |
| | 1331 JCPS | \$627.00 |
| Holder Arm - | 1331 JPH9 | \$440.00 |
| | 1331 JUH | \$445.00 |
| | 1331 JH | \$440.00 |
| | 1331 JHZ | \$440.00 |
| | 1331 JPH10 | \$476.00 |
| | 1331 JPSH | \$522.00 |
| | 1331 JCPSH | \$689.00 |

NOTE: Arms unique to 1331 Series Door Closers
JPH10 is handed. Please specify handing when ordering.

1331 Closer – Parts & Accessories

Adjustable Size 1-6

| Description | Part Number | Price |
|--|-------------|----------|
| Mortise Nuts – When Ordered w/Closer – No Charge | 4TB | \$14.00 |
| Drop Plate – For Parallel Arm | 1331D | \$84.00 |
| Mounting Plate (Top Jamb) | 1331B | \$84.00 |
| Standard Cover, High Impact, Non-Corrosive | 1331C | \$30.00 |
| Environmentally friendly ABS plastic cover | 1331CEC | \$35.00 |
| Body Only | CB-1331 | \$278.00 |
| Standard/Top Jamb Arm | 25JO | \$135.00 |
| Parallel Arm | 25JP9 | \$135.00 |
| Standard/Top Jamb Hold Open Arm | 25JH | \$180.00 |
| | 25JOZ | \$136.00 |
| Hold Open | 25JHZ | \$203.00 |
| | 25JPS | \$220.00 |
| Hold Open | 25JPSH | \$290.00 |
| | 25JP10 | \$180.00 |
| Hold Open | 25JPH10 | \$220.00 |
| | 25JCPS | \$367.00 |
| Hold Open | 25JCPSH | \$431.00 |
| Parallel Hold Open Arm | 25JPH9 | \$176.00 |
| Parallel Arm Bracket; Converts JO to JP9 | 125JP9 | \$26.00 |
| Parallel Arm Bracket; Converts JH to JPH9 | 125JPH9 | \$26.00 |
| Support bracket | 125JV | \$28.00 |
| Angle bracket | 125JVF | \$49.00 |
| Screw Pack for all 1331 Arms | 61-2765 | \$13.45 |

1131 Series Door Closer – Regular, Parallel and Top Jamb Mount

| Description | Arm | Finish | EB/EN |
|----------------|-------------------------------|--------|----------|
| Standard Arm - | 1131 RU (Adjustable size 1-6) | | \$232.00 |
| Holder Arm - | 1131 HU (Adjustable size 1-6) | | \$265.00 |

NOTE: Supplied Standard with machine screws and Mortise Nuts for 1-3/4" doors and self-tapping screws.

NOTE: Arms unique to 1131 Series Door Closers

Closers packed to mount as parallel arm, top jamb, or standard mount.

Accessories

| | | |
|---------|--|--------------|
| 60-0535 | Cover ordered separately for 1131 Closer | \$15.00 Each |
|---------|--|--------------|

USA & Canada Prices Effective June 3, 2019

| Part No. | Description | Price | Part No. | Description | Price |
|-----------|---|----------|-----------|---|----------|
| 01-0134 | Machine screw #8-32 x 13/16" | \$0.29 | * 63-2230 | Main Arm & Swivel Asy. (HZ-Arm) | \$71.91 |
| 01-0287 | Set Screw (used w/63-3905) | \$0.67 | * 63-2231 | Main Arm & Swivel Asy (HZA-Arm) | \$71.91 |
| 01-0864 | Hole Plug (PS/PSH Arm) | \$1.76 | * 63-2240 | Main Arm & Link Asy. LH (F-Arms 160) | \$359.36 |
| 01-1028 | Machine screw #8-32 x 1/4" | \$0.77 | * 63-2241 | Main Arm & Link Asy. RH (F-Arms 160) | \$359.36 |
| * 01-1143 | 12-24 x 5/8" Screw | \$0.89 | * 63-2242 | Main Arm & Link Asy. LH (F-Arms 125) | \$359.36 |
| 01-1157 | Cover Screw 8-32 x 1-1/4" | \$0.31 | * 63-2243 | Main Arm & Link Asy. RH (F-Arms 125) | \$359.36 |
| 01-1190 | Steel Screw | \$1.68 | * 63-2245 | Foot Bracket LH (PF9-Arm) | \$285.66 |
| * 01-1191 | Pan Hd Screw 10-24 x 3/8" | \$0.89 | * 63-2246 | Foot Bracket RH (PF9-Arm) | \$285.66 |
| * 01-1206 | Cover Screw 8-32 x 5/16" | \$0.73 | * 63-2270 | Foot Asy. (P3-Arm) | \$71.91 |
| 01-1248 | Machine Screw 12-24 x 1-5/16" | \$1.60 | * 63-2272 | Foot Asy. (P4A-Arm) | \$92.45 |
| 01-1463 | Adjusting Rod Screw | \$1.96 | * 63-2273 | Foot Asy. (F8, O8-Arms) | \$61.52 |
| * 01-2300 | 12 x 1-1/2" Wood Screw | \$0.89 | * 63-2274 | Foot Asy. (P3A-Arm) | \$71.91 |
| 01-2303 | 12 x 2-1/2" Wood FI Hd Screw | \$1.94 | * 63-2289 | Foot Asy. LH (H8-Arm) | \$116.32 |
| 01-2306 | Wood Flat Hd Screw #12 x 3" | \$1.93 | * 63-2290 | Foot Asy. RH (H8-Arm) | \$116.32 |
| 01-3438 | 12-24 x 1-3/4" Track Mtg. Screw | \$1.60 | * 63-2295 | Foot Asy. (P4-Arm) | \$82.13 |
| 01-3440 | Flat Hd Screw 12-24 x 2-1/4" | \$1.60 | * 63-2391 | Screw Pack | \$24.71 |
| * 01-3458 | Flat Hd Screw 1/4-20 x 2-1/2" | \$1.68 | * 63-2392 | Screw Pack | \$24.71 |
| * 01-3595 | Screw 8-32 Unf x 1/4" | \$0.97 | * 63-2396 | Screw Pack (Stop & Spacer Pack – PS & PSH) | \$26.62 |
| 01-4411 | Screw 12-24 x 3/8" | \$0.63 | * 63-2398 | Screw Pack (CPS) | \$72.62 |
| 01-4451 | Screw 10-24 x 3/8" | \$1.68 | * 63-2444 | (POT) Track Assy. Only | \$225.95 |
| 01-4503 | #12-24 x 3/8" Pan Head Screw | \$9.54 | * 63-2445 | (PHT) Track Assy. Only | \$246.47 |
| 01-9063 | Washer Spindle | \$0.15 | * 63-2447 | (OT) Track Assy. Only | \$225.95 |
| 01-9204 | Self drilling tapping case mounting screw | \$0.29 | * 63-2448 | (HT) Track Assy. Only | \$246.47 |
| 01-9210 | Self drilling tapping case mounting screw | \$0.47 | * 63-2468 | Foot Assy. (F-Arm) | \$51.33 |
| * 01-9145 | Screw (pivot) | \$1.78 | 63-2487 | Ft. Brkt and Bdy Asy (LH) | \$249.96 |
| 61-0007 | 165 Degree Fusible Link – replacement | \$21.10 | 63-2488 | Ft. Brkt and Bdy Asy (RH) | \$249.96 |
| 61-0010 | 125 Degree Fusible Link – replacement | \$21.10 | * 63-2549 | Main Arm & Link Asy. (OLC-Arm) | \$61.52 |
| 61-0211 | Friction Disc (PH Arms) | \$2.48 | * 63-2607 | Main Arm & Link Asy. (O, O8, OZ, OZA, P3, P3A, P4A, P9, RP9, UO-Arms) | \$51.33 |
| 61-0293 | Bushing | \$5.00 | 63-2868 | Smoke Detector | \$16.76 |
| 61-0294 | Washer | \$0.68 | * 63-3070 | MAIN ARM & SWIVEL ASSY | \$71.91 |
| * 61-0308 | Swivel arm screw | \$5.77 | 63-3264 | Channel assy. -268 OB | \$161.37 |
| * 61-2303 | Foot Asy. (H, HZ, HZA, PH4, PH9, UH-Arms) | \$94.88 | 63-3265 | Channel assy. - 268 H | \$232.36 |
| * 61-2761 | JO Main Arm Assy. | \$42.64 | 63-3266 | Channel assy. - 268 HB | \$261.40 |
| * 61-2762 | JH Main Arm Assy. | \$42.64 | 63-3394 | Main Arm Assy - 280 RH | \$76.04 |
| * 61-2765 | Screw Pack | \$13.45 | 63-3395 | Main Arm Assy 280- LH | \$76.04 |
| * 63-0073 | Main Arm Concealed - LH | \$129.60 | * 63-3405 | P9 Foot Assembly | \$22.18 |
| 63-0088 | H.O. Channel | \$77.46 | 63-3413 | Switch and Plug Assembly | \$88.66 |
| * 63-0157 | Channel – OT/OTB/HT/HTB | \$133.09 | 63-3481 | Screw Pack – for 281 "O" Arm | \$9.36 |
| * 63-0159 | Channel - POT/POTB/PHT/PHTB | \$116.32 | 63-3482 | Track Screw pack | \$11.65 |
| 63-0191 | Spacer (5th hole) | \$20.14 | * 63-3487 | CPSH arm mounting screw pack | \$80.66 |
| * 63-0211 | Stop Only | \$17.11 | 63-3493 | Bumper Only (CPS, CPSH-Arms) | \$51.33 |
| 63-0377 | Bumper | \$21.62 | 63-3620 | 268/278 Base Plate Asy. CPS | \$123.21 |
| 63-0396 | Bumper stop | \$4.32 | 63-3640 | 268 Screw Pack | \$14.97 |
| * 63-0516 | Holder | \$92.45 | 63-3641 | 268 CSP/CSPS/CSPD Screw Pack | \$77.94 |
| 63-0555 | Mounting Bracket | \$41.55 | 63-3642 | Screw Pack | \$25.71 |
| * 63-0641 | Heavy Duty – Main Arm | \$41.14 | * 63-3684 | 351 "O" Screw Pack | \$5.20 |
| 63-0678 | Spring support | \$5.20 | * 63-3656 | Main arm assy LH | \$77.75 |
| * 63-0682 | Track End Cap | \$10.21 | * 63-3657 | Main arm assy RH | \$77.75 |
| 63-0694 | Hex Wrench for Heavy Duty Arm | \$5.69 | * 63-3727 | P10 Arm & Brax | \$92.45 |
| * 63-0700 | Pivot | \$7.42 | 63-3788 | Ball Insert Asy. - CPSH | \$14.35 |
| 63-2063 | Spring slide assy. | \$48.05 | * 63-3830 | CPS Brax & Arm Asy. | \$243.33 |
| * 63-2188 | Main Arm Assy. Concealed (LH) | \$129.60 | * 63-3833 | PSH Brax & Arm Asy. | \$164.21 |
| * 63-2189 | Main Arm Assy. Concealed (RH) | \$129.60 | * 63-3835 | SP10 H/D Arm Asy. | \$218.66 |
| * 63-2216 | Foot Asy. (O, OLC, RO, UO, RUO-Arms) | \$41.14 | * 63-3836 | CPSH Arm & Brax | \$243.33 |
| * 63-2217 | Foot Asy. (OZ-Arm) | \$51.33 | * 63-3837 | PS H/D Brax & Arm Asy. | \$98.53 |
| * 63-2218 | Foot Asy. (OZA, FZA-Arms) | \$51.33 | | | |

* Price listed are for painted finishes or non finishes. For plated finishes, please refer to page DC-5 for finish add.

DC-10 DOOR CLOSERS

SARGENT®

ASSA ABLOY

PARTS

USA & Canada Prices Effective June 3, 2019

| Part No. | Description | Price |
|-----------|---------------------------------------|----------|
| * 63-3839 | PH10 Arm & Brax – LH | \$123.21 |
| * 63-3840 | PH10 Arm & Brax – RH | \$123.21 |
| * 63-3901 | Track Arm Asy. (to be used w/63-3905) | \$71.91 |
| 63-3905 | Roller Asy. (used w/01-0287) | \$11.73 |
| 63-3923 | 268/281 Screw Pack (PSSPT) | \$43.23 |
| 63-3924 | 268/281 Screw Pack (SSPT) | \$51.88 |
| 63-3925 | 268/281 Screw Pack (SSP) | \$48.39 |
| 63-4332 | Extended Wiring Harness | \$48.31 |
| 63-4335 | 268 CSPS/CSPD Circuit Tester | \$71.75 |
| 64-0026 | Bearing | \$2.61 |
| * 64-0050 | Foot Bracket (PH4-Arm) | \$61.52 |
| 64-0175 | Plastic Cover Support Spacer-1431 | \$1.58 |
| 64-0180 | Plastic Support for metal cover | \$4.32 |
| * 64-2407 | Screw Pack (1431-0) | \$24.71 |
| 64-2408 | Screw Pack-Track Type | \$24.71 |
| 64-2409 | Screw Pack (1431) | \$20.56 |

* Price listed are for painted finishes or non finishes. For plated finishes, please refer to page DC-5 for finish add.

| Overhead Door Holders & Stops Options | | |
|--|---|-------------|
| Options | Description | Price |
| CPC | Clear Powder Coat over 26D – Orders will continue to be handled as Special | \$135.00 |
| 31 | For Doors more than 1-3/4" up to 2-1/4" thick – specify thickness when ordering | No Add |
| 36 | Torx Security Machine Screws for door 1-3/4" Thick ONLY | Add \$24.00 |

*Option available for Overhead Holders & Stops Only

| Overhead Door Holders & Stops | | EB/ED/EN/ EP/EAB | 10BE/26D/ BSP/WSP | 04/10/10B | 03/09/10BL/ 15/20D/26 |
|--|-------------------------------------|---------------------|----------------------|-----------|--------------------------|
| Catalog Number | Description | | | | |
| 597 thru 599 | Add Suffix H or S (Surface Mount) | \$514.00 | \$514.00 | \$601.00 | \$704.00 |
| 697 thru 699 | Add Suffix H or S (Concealed Mount) | \$389.00 | \$389.00 | \$601.00 | \$698.00 |

H-Hold-open w/stop **S**-Stop only

| | | | | | |
|----------------|---|----------|----------|----------|----------|
| 1536 thru 1539 | Add Suffix F, H, or S (Concealed Mount) | \$178.00 | \$178.00 | \$225.00 | \$290.00 |
| 1546 thru 1549 | Add Suffix F, H, or S (Surface Mount) | \$206.00 | \$206.00 | \$283.00 | \$346.00 |

F-Friction type holder **H**-Non-friction type Stop & Holder **S**-Stop only

| Overhead Door Holders & Stops Accessories | | EB/ED/EN/EP/EAB/ 10BE/26D/BSP/WSP | 04/10/10B | 03/09/10BL/ 15/20D/26 |
|--|--|--------------------------------------|-----------|--------------------------|
| Catalog Number | Description | | | |
| 145 | Angle Bracket for 1540 Series | \$63.00 | \$71.00 | \$77.00 |
| 195 | Angle Bracket for 590 Series (handed) | \$69.00 | \$75.00 | \$81.00 |
| * 21-0104 | Jamb Bracket Shim for 590 - 1/4" thick – order screws separately | \$26.92 | \$34.11 | \$41.25 |
| * 01-3454 | 1/4-20 x 1-1/4" Machine Screw - used w/21-0104 Bracket | \$2.18 | \$2.18 | \$2.18 |
| * 21-0198 | Jamb Bracket Shim for 1540 - 1/4" thick – order screws separately | \$19.72 | \$26.92 | \$34.11 |
| 01-3436 | 12-24 x 1-1/4" Machine Screw - used w/21-0198 Bracket | \$1.85 | \$1.85 | \$1.85 |
| * 21-0396 | 690H Turn Lever, for doors up to 1-3/8" to 1 3/4" thick | \$9.71 | \$13.75 | \$16.44 |
| * 21-0397 | 690H Turn Lever, for doors 1-7/8" – 2-1/4" thick | \$10.50 | \$14.54 | \$17.25 |
| 21-0079 | 590 Thru-bolt for 1-1/4" – 2" Door | \$3.91 | \$3.91 | \$3.91 |
| 21-2019 | 1530 Series "H", "S", "F" Screw Pack | \$8.16 | \$8.16 | \$8.16 |

* Specify finish when ordering.

HS-2 HOLDERS & STOPS

SARGENT®

ELECTROMAGNETIC DOOR HOLDER

ASSA ABLOY

USA & Canada Prices Effective June 3, 2019

| Electromagnetic Door Holder | | | |
|------------------------------------|--|---------------|--------------|
| Part # | Description | Finish | Price |
| 1560 | Wall Mount, Surface Applied Wiring | EN | \$395.00 |
| 1561 | Wall Mount, Concealed Wiring (in a junction box) | EN | \$379.00 |
| 1562 | Floor Mount, Single Door | EN | \$674.00 |
| 1563 | Floor Mount, Double Door | EN | \$880.00 |
| Part # | Parts & Accessories Description | Finish | Price |
| 52-0302 | Surface Mounting Box | EN | \$101.87 |
| 52-0303 | Wall Cover | EN | \$70.42 |
| 52-0304 | Magnet Housing Cover - Single Floor | EN | \$353.58 |
| 52-0305 | Magnet Housing Cover - Double | EN | \$494.40 |
| 52-0306 | Magnet Support Bracket | | \$34.47 |
| 52-0307 | Magnet Housing Base, Single Floor | EN | \$215.75 |
| 52-0308 | Magnet Housing Base, Double Floor | EN | \$317.60 |
| 52-0309 | Floor Gasket | | \$22.46 |
| 52-2570 | Magnet - Wall Mount | | \$187.26 |
| 52-2571 | Magnet - Floor | | \$160.27 |
| 52-2572 | Door Armature | | \$125.85 |
| 52-2573 | Extension & Screw | EN | \$116.86 |
| 52-2574 | Screw Kit (for 1561) | EN | \$31.46 |
| 52-2575 | Screw Kit (for 1560) | EN | \$31.46 |
| 52-2576 | Screw Kit - Single Floor | EN | \$83.90 |
| 52-2577 | Screw Kit - Double Floor | EN | \$104.87 |

USA & Canada Prices Effective June 3, 2019

EXIT DEVICES

How to Order/ANSI Finish & Function Comparison ED-1

20 Series

20 Series Options..... ED-2

20 Series Reversible SVR & Rim Device ED-3

30 Series

30 Series Options..... ED-4

30 Series Reversible SVR & Rim Device ED-5

9898 Series

9898 Series Options..... ED-6

9898 Reversible Rim Device..... ED-7

80 Series

8300 Series Options..... ED-8

8300 Series Narrow Mortise Device ED-9

AD8400 Series Options..... ED-10

AD8400 Series Narrow Concealed Vertical Rod ED-11

MD8400 Series Options ED-12

MD8400 Series Narrow Concealed Vertical Rod..... ED-13

AD8500 Series Options..... ED-14

AD8500 Series Narrow Rim Device ED-15

8500 Series Options..... ED-16

8500 Series Concealed Vertical Rod – Metal Door ED-17

AD8600 Series Options..... ED-18

AD8600 Series Concealed Vertical Rod – Metal Door ED-19

MD8600 Series Options ED-20

MD8600 Series Concealed Vertical Rod – Wood Door ED-21

WD8600 Series Options..... ED-22

WD8600 Series Concealed Vertical Rod – Wood Door..... ED-23

LS, LP, LR8600 Series Options ED-24

LS, LP, LR8600 Series Concealed Vertical Rod
– Low Profile ED-25

8700 Series Options..... ED-26

8700 Series Surface Vertical Rod..... ED-27

NB8700 Series Options..... ED-28

NB8700 Series Surface Vertical Rod..... ED-29

FM8700 Series Options ED-30

FM8700 Series-Surface Vertical Rod-Complies with
FEMA 361 ED-31

8888 Series Options ED-32

8800 Series Rim..... ED-33

8888 Series Options..... ED-34

8888 Reversible Rim Exit Device..... ED-35

8900 Series Options..... ED-36

8900 Series Mortise ED-37

90 Series

9400 Series Options..... ED-38

9400 Series Narrow Stile Concealed Vertical Rod ED-39

9700 Exit Options..... ED-40

9700 Series Surface Vertical Rod..... ED-41

9800 Series Options..... ED-42

9800 Series Rim..... ED-43

9900 Series Options..... ED-44

9900 Series Mortise ED-45

Trim

ET Standard, Coastal Series, and Studio Collection (Except Gramercy Series)

Lever Control Trim ED-46

Freewheeling ET Standard, Coastal Series, and Studio Collection (Except Gramercy Series)

Lever Control Trim ED-47

ET Gramercy Series Lever Control Trim..... ED-48

Freewheeling ET Gramercy Series Lever Control Trim..... ED-49

Pull & Thumbpiece Trim, Dummy Rails, & Misc. Trims

Pull & Thumbpiece Trim..... ED-50

Dummy Rails/AVT Trim, Aux Control Trim, PRK Trim..... ED-51

Mullions & Accessories

Mullions & Accessories ED-52 to ED-53

Accessories ED-54 to ED-55

Strikes ED-56

TABLE OF CONTENTS

USA & Canada Prices Effective June 3, 2019

Parts

| | |
|-------------------------|-------|
| 01-0007 to 28-2014..... | ED-57 |
| 28-2026 to 68-0618..... | ED-58 |
| 68-0632 to 68-1326..... | ED-59 |
| 68-1363 to 68-2460..... | ED-60 |
| 68-2461 to 68-2925..... | ED-61 |
| 68-2926 to 68-3311..... | ED-62 |
| 68-3314 to 68-3941..... | ED-63 |
| 68-3945 to 68-4341..... | ED-64 |
| 68-4342 to 68-4688..... | ED-65 |
| 68-4689 to 68-5554..... | ED-66 |
| 68-5559 to 94-2379..... | ED-67 |
| 94-2380 to 97-2038..... | ED-68 |
| 97-2039 to 99-0088..... | ED-69 |
| 99-0098 to 99-2526..... | ED-70 |

GENERAL INFORMATION

USA & Canada Prices Effective June 3, 2019

How To Order

| Step | Description | Example |
|----------------|--|--|
| Quantity | Each | 10 Ea. |
| Option | Consult proper section for options available | 10 Ea. 12- |
| Series | 20, 30, 80, 90 | 10 Ea. 12-87 |
| Function | Consult proper section for functions available | 10 Ea. 12-8713 |
| Rail Size | E, F, J, G, Consult catalog for description | 10 Ea. 12-8713 G |
| Trim | Consult proper section for trims available | 10 Ea. 12-TB 8713 G ETL |
| Thru Bolts | If required | 10 Ea. 12-TB 8713 G ETL |
| Strike | Specify if other than standard | 10 Ea. 12-TB 8713 G ETL 653 |
| Hand | Consult proper section for handing required | 10 Ea. 12-TB 8713 G ETL 653 RHR |
| Finish | Consult proper section for finishes available | 10 Ea. 12-TB 8713 G ETL 653 RHR 32D |
| Misc. Options | Consult proper section for options available | 10 Ea. 12-TB 8713 G ETL 653 RHR 32D x 7'6" Door Ht. |
| Split Finishes | Specify outside finish first | 10 Ea. 12-8813 F ETL US10B/32D RHR |

ANSI Finish and Function Comparison

| Function | | Finish | | |
|-----------------------------|------|---------|------|---|
| SARGENT | ANSI | SARGENT | ANSI | Description |
| 10 | 01 | US3 | 605 | Polished Brass |
| 28 | 01 | US4 | 606 | Satin Brass |
| 88 | 01 | US9 | 611 | Polished Bronze |
| 98 | 01 | US10 | 612 | Satin Bronze |
| 10-DT | 02 | US10B | 613 | Oxidized Satin Bronze/Oil Rubbed |
| 28-DT | 02 | US10BE | 613E | Dark Oxidized Satin Bronze - Equivalent |
| 88-DT | 02 | US10BL | — | Oxidized Satin Bronze/Lacquered |
| 98-DT | 02 | US14 | 618 | Bright Nickel, Clear Coated |
| 04 | 03 | US15 | 619 | Satin Nickel Plate |
| 10-DT (16-Option) | 04 | US20D | — | Dark Statuary Bronze Powder Coated |
| 88-DT (16-Option) | 04 | US26 | 625 | Polished Chrome |
| 63 | 05 | US26D | 626 | Satin Chrome |
| 62 | 06 | US32 | 629 | Polished Stainless Steel |
| 66 | 07 | US32D | 630 | Satin Stainless Steel |
| 13 | 08 | BSP | — | Black Suede Powder Coat |
| 06 | 09 | WSP | — | White Suede Powder Coat |
| 16 | 10 | EB | — | Powder Coated to match 10B |
| 10 x Auxiliary Control (13) | 11 | ED | — | Powder Coated to match 20D |
| 10 x Auxiliary Control (06) | 12 | EN | — | Powder Coated to match US28 |
| | | EP | — | Powder Coated to match 10 |
| | | ED | — | Sprayed to match 20D |
| | | EAB | — | Powder Coated Satin Brass Enamel |

ED-2 EXIT DEVICES

SARGENT®

ASSA ABLOY

20 SERIES OPTIONS

USA & Canada Prices Effective June 3, 2019

| Options | Description | Price |
|---------|--|----------------|
| 10 | SARGENT Signature System | \$58.00 /cyl. |
| 11 | SARGENT XC Key System (not available w/10, 22, KESO, SC, & SE options) | No addition |
| *1160 | SARGENT XC Large Format Interchangeable Plastic Disposable Construction Core | No addition |
| *1163 | SARGENT XC Large Format Interchangeable Core Cylinder – Includes masterkeying charges | \$77.00 |
| *1164 | SARGENT XC Large Format Interchangeable Construction Core Cylinder | \$77.00 |
| *1170 | Small Format interchangeable disposable construction core - to accept 7 Pin XC permanent core | No addition |
| *11727P | Small Format interchangeable keyed construction core - to accept 7 Pin XC permanent core | \$69.00 |
| *11737P | Small Format interchangeable core - to accept 7 pin XC permanent core | \$69.00 / cyl. |
| 12 | UL Fire Label Exit Devices (not available with 16- option) | \$171.00 |
| 16 | Cylinder lockdown feature (not available with 12- option) | \$123.00 |
| 21 | SARGENT Construction Key System (lost ball) | \$16.00 /cyl. |
| 22 | SARGENT Construction Key System (split key) | \$32.00 /cyl. |
| *60 | SARGENT Large Format Interchangeable Plastic Disposable Construction Core | No addition |
| *63 | SARGENT Large Format Interchangeable Core Cylinder includes master and grandmaster keying charge | \$77.00 /cyl. |
| *64 | SARGENT Large Format Interchangeable Construction Core Cylinder | \$77.00 |
| *6573 | Small Format 6-Pin uncombined core | \$59.00 /cyl. |
| *65737P | Small Format 7-Pin uncombined core | \$59.00 /cyl. |
| *70 | Small Format Interchangeable disposable plastic construction core | No addition |
| *72 | Small Format Interchangeable construction core (7-pin with 11 option) | \$69.00 |
| *73 | Small Format 6-Pin Interchangeable core | \$69.00 /cyl. |
| *737P | Small Format 7-Pin Interchangeable core | \$69.00 /cyl. |
| BR | SARGENT Bump Resistant Cylinders (N/A w/10, 22, 30, 60, 63, 64, 70, 72, 73, 737P, KESO, SC, SE) | \$23.00 /cyl. |
| DG1 | Patented Degree DG1 Key System | No Addition |
| DG160 | Hardware prepared for DG1-6300 Lg. Format IC cores, supplied with temporary plastic construction cores | No addition |
| DG163 | Patented Degree DG1 Large Format Interchangeable Core Cylinder - Includes master keying charges | \$77.00 |
| DG164 | Hardware prepared for DG1-6300 Lg. Format IC cores, supplied with temporary keyed construction cores | \$77.00 |
| DG2 | Patented Degree DG2 Key System incorporating a locking sidebar | \$58.00/cyl. |
| DG260 | Hardware prepared for DG2-6300 Lg. Format IC cores, supplied with temporary plastic construction cores | No addition |
| DG263 | Patented Degree DG2 Large Format Interchangeable Core Cylinder - Includes master keying charges | \$135.00 |
| DG264 | Hardware prepared for DG2-6300 Lg. Format IC cores, supplied with temporary keyed construction cores | \$77.00 |
| DG3 | Patented Degree DG3 Key System incorporating a locking sidebar and UL437 listed | \$82.00/cyl. |
| DG360 | Hardware prepared for DG3-6300 Lg. Format IC cores, supplied with temporary plastic construction cores | No addition |
| DG363 | Patented Degree DG3 Large Format Interchangeable Core Cylinder - Includes master keying charges | \$159.00 |
| DG364 | Hardware prepared for DG3-6300 Lg. Format IC cores, supplied with temporary keyed construction cores | \$77.00 |
| LC | Less Cylinder Deduct for LL, LP, LB, OB Trims | -\$87.00/cyl. |
| LC | Less Cylinder Deduct for GTB, TP, or 16 Option | -\$89.00/cyl. |
| SC | Schlage C Keyway Cylinder 0-Bitted (Rim & #41 Mortise Cylinder Only & Lever Trim Only) | No addition |
| SE | Schlage E Keyway Cylinder 0-Bitted (Rim & #41 Mortise Cylinder Only & Lever Trim Only) | No addition |
| TB | For 2727 Series | \$74.00 |
| TB | For 2828 Series | \$24.00 |

* Note: For lever trim listed on ED-3 only.

| | |
|---|-------------|
| Vertical Rod Device to 96" Height | No addition |
| Concealed/Surface Vertical Rod Device over 96" to 120" Height | \$60.00 |

Refer to catalog for max. door height availability on fire rated exit devices.

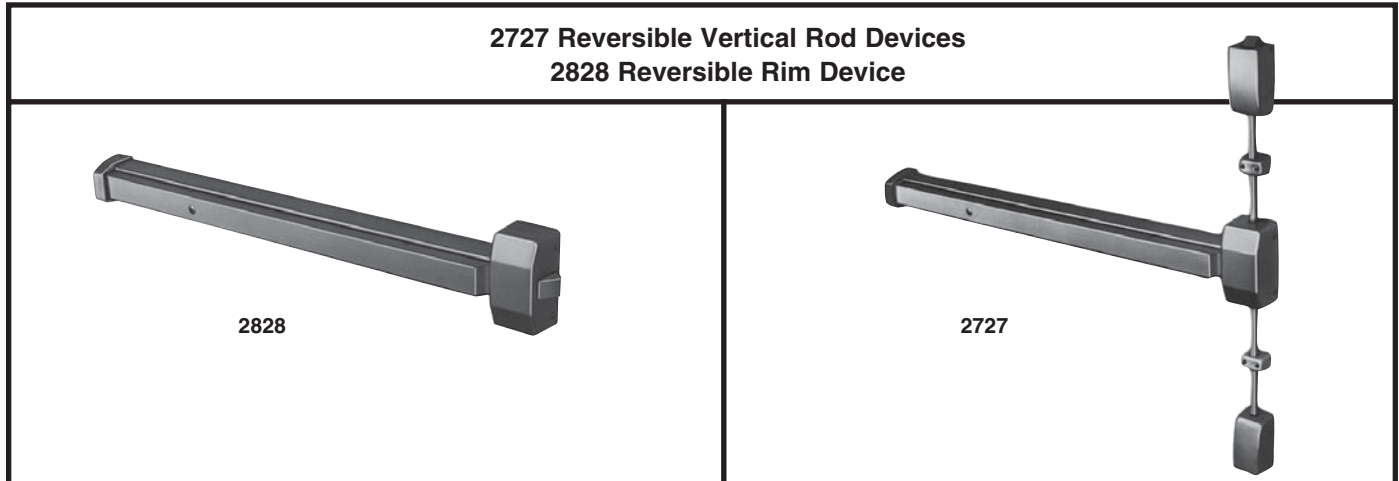

| <u>Less Trim</u> | | | | Finish | |
|--|-------------------------------|--|------------|---------------------|---------------|
| Device | | | | EN/EB/ED/EP/EAB | |
| 2727 | | | | \$1,340.00 | |
| 2828 | | | | \$730.00 | |
| <u>20 Series Trim</u> | | 03/04/09/10/10B/10BE/ 10BL/14/15/26/26D/BSP/WSP | | EN/EB/ED/ EP/EAB | |
| Function * Note: For use with 2828 Device only | | Trim | | | |
| 28C | Key locks/Unlocks trim (13) | LL, LP, LB | | | |
| 28D | Dummy Trim (lever) (10) | LL, LP, LB | \$354.00 | | |
| 28K | Key retracts Latchbolt (04) | LL, LP, LB | | | |
| 28L | Trim always operable (15) | LL, LP, LB | | | |
| 28N | Key operates lever (06) | LL, LP, LB | | | |
| 28C | Key locks/Unlocks trim (13) | OB | | | |
| 28K | Key retracts latchbolt (04) | OB | \$230.00 | | |
| 28L | Trim always operable (15) | OB | | | |
| 810 | Dummy Trim (pull) | GTB | | \$100.00 | |
| 802 | Blank Plate | GTB | | \$97.00 | |
| 814 | Key retracts latchbolt (pull) | HTB | | \$197.00 | |
| <u>Thumbpiece Trim (not retrofittable to Exits shipped prior to February 25, 2000)</u> | | | | EN/EB/EAB | |
| 810 | Dummy Trim | TP | | \$133.00 | |
| 866 | Key locks/unlocks thumbpiece | TP | | \$319.00 | |
| 814 | Key retracts latch | TP | | \$291.00 | |
| 828 | Trim always operable | TP | | \$164.00 | |
| <u>Thru Bolt Application</u> | | Pack Part # | | Finish | |
| | | No. Bolts per Pack | 1-3/4" Dr. | 2-1/4" Dr. | |
| 2828, 12-2828 | | 4 | 28-2024 | 28-2025 | \$27.00 Pack |
| 2727 | | 14 | 28-2031 | 28-2032 | \$96.00 Pack |
| 12-2727 | | 16 | 28-2087 | 28-2088 | \$109.00 Pack |

ED-4 EXIT DEVICES

SARGENT®

ASSA ABLOY

30 SERIES OPTIONS

USA & Canada Prices Effective June 3, 2019

| Options | Description | Price |
|---------|--|----------------|
| 10 | SARGENT Signature System | \$58.00 /cyl. |
| 11 | SARGENT XC Key System (not available w/10, 22, KESO, SC, & SE options) | No addition |
| *1160 | SARGENT XC Large Format Interchangeable Plastic Disposable Construction Core | No addition |
| *1163 | SARGENT XC Large Format Interchangeable Core Cylinder – Includes masterkeying charges | \$77.00 |
| *1164 | SARGENT XC Large Format Interchangeable Construction Core Cylinder | \$77.00 |
| *1170 | Small Format interchangeable disposable construction core - to accept 7 Pin XC permanent core | No addition |
| *11727P | Small Format interchangeable keyed construction core - to accept 7 Pin XC permanent core | \$69.00 |
| *11737P | Small Format interchangeable core - to accept 7 pin XC permanent core | \$69.00 / cyl. |
| 12 | UL Fire Label Exit Devices (not available with 16- option) | \$171.00 |
| 16 | Cylinder lockdown feature (not available with 12- option) | \$123.00 |
| 21 | SARGENT Construction Key System (lost ball) | \$16.00 /cyl. |
| 22 | SARGENT Construction Key System (split key) | \$32.00 /cyl. |
| 55 | Signal Switch in Rail | \$223.00 |
| *60 | SARGENT Large Format Interchangeable Plastic Disposable Construction Core | No addition |
| *63 | SARGENT Large Format Interchangeable Core Cylinder includes master and grandmaster keying charge | \$77.00 /cyl. |
| *64 | SARGENT Large Format Interchangeable Construction Core Cylinder | \$77.00 |
| *6573 | Small Format 6-Pin uncombined core | \$59.00 /cyl. |
| *65737P | Small Format 7-Pin uncombined core | \$59.00 /cyl. |
| *70 | Small Format Interchangeable disposable plastic construction core | No addition |
| *72 | Small Format Interchangeable construction core (7-pin with 11 option) | \$69.00 |
| *73 | Small Format 6-Pin Interchangeable core | \$69.00 /cyl. |
| *737P | Small Format 7-Pin Interchangeable core | \$69.00 /cyl. |
| BR | SARGENT Bump Resistant Cylinders (N/A w/10, 22, 30, 60, 63, 64, 70, 72, 73, 737P, KESO, SC, SE) | \$23.00 /cyl. |
| DG1 | Patented Degree DG1 Key System | No Addition |
| DG160 | Hardware prepared for DG1-6300 Lg. Format IC cores, supplied with temporary plastic construction cores | No addition |
| DG163 | Patented Degree DG1 Large Format Interchangeable Core Cylinder - Includes master keying charges | \$77.00 |
| DG164 | Hardware prepared for DG1-6300 Lg. Format IC cores, supplied with temporary keyed construction cores | \$77.00 |
| DG2 | Patented Degree DG2 Key System incorporating a locking sidebar | \$58.00/cyl. |
| DG260 | Hardware prepared for DG2-6300 Lg. Format IC cores, supplied with temporary plastic construction cores | No addition |
| DG263 | Patented Degree DG2 Large Format Interchangeable Core Cylinder - Includes master keying charges | \$135.00 |
| DG264 | Hardware prepared for DG2-6300 Lg. Format IC cores, supplied with temporary keyed construction cores | \$77.00 |
| DG3 | Patented Degree DG3 Key System incorporating a locking sidebar and UL437 listed | \$82.00/cyl. |
| DG360 | Hardware prepared for DG3-6300 Lg. Format IC cores, supplied with temporary plastic construction cores | No addition |
| DG363 | Patented Degree DG3 Large Format Interchangeable Core Cylinder - Includes master keying charges | \$159.00 |
| DG364 | Hardware prepared for DG3-6300 Lg. Format IC cores, supplied with temporary keyed construction cores | \$77.00 |
| LC | Less Cylinder Deduct for LL, LP, LB, OB Trims | -\$87.00/cyl. |
| LC | Less Cylinder Deduct for GTB, TP, or 16 Option | -\$89.00/cyl. |
| NB | No Bottom Rod for 3727 Devices | No Addition |
| SC | Schlage C Keyway Cylinder 0-Bitted (Rim & #41 Mortise Cylinder Only & Lever Trim Only) | No addition |
| SE | Schlage E Keyway Cylinder 0-Bitted (Rim & #41 Mortise Cylinder Only & Lever Trim Only) | No addition |
| TB | For 3727 Series | \$74.00 |
| TB | For 3828 Series | \$24.00 |

* Note: For lever trim listed on ED-5 only.

Vertical Rod Device to 96" Height No addition

Concealed/Surface Vertical Rod Device over 96" to 120" Height \$60.00

Refer to catalog for max. door height availability on fire rated exit devices.

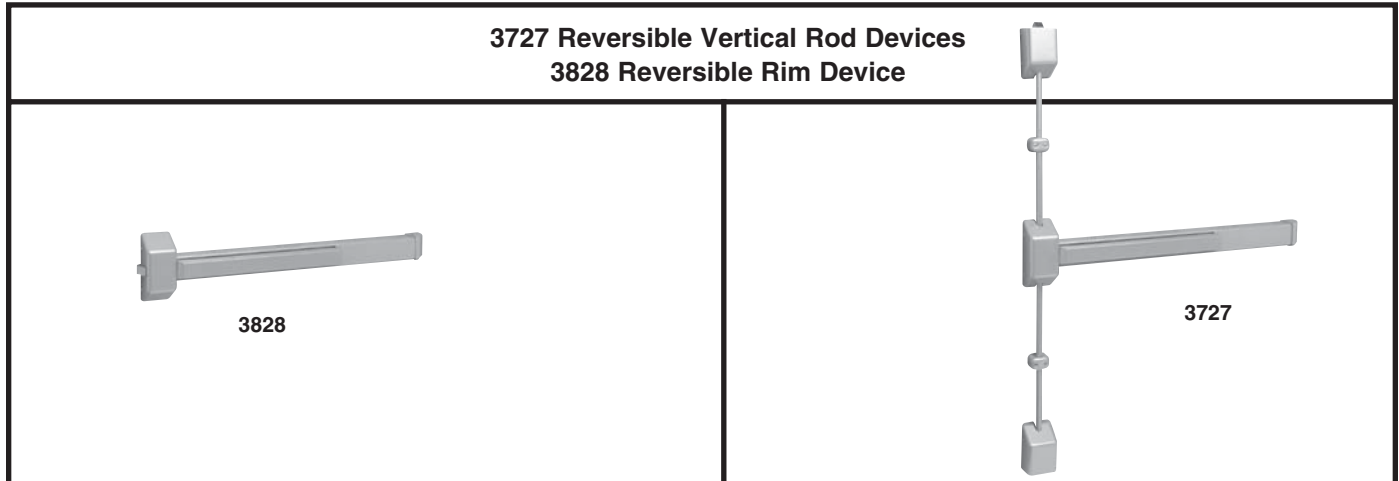

| <u>Less Trim</u> | | | | Finish | |
|---|-------------------------------|--|------------|---------------------|---------------|
| Device | | | | EN/EB/ED/EP/EAB | |
| 3727 | | | | \$956.00 | |
| 3828 | | | | \$547.00 | |
| <u>30 Series Trim</u> | | 03/04/09/10/10B/10BE/ 10BL/14/15/26/26D/BSP/WSP | | EN/EB/ED/ EP/EAB | |
| Function * Note: For use with 3828 Device only Trim | | | | | |
| 28C | Key locks/Unlocks trim (13) | LL, LP, LB | | | |
| 28D | Dummy Trim (lever) (10) | LL, LP, LB | \$354.00 | | |
| 28K | Key retracts Latchbolt (04) | LL, LP, LB | | | |
| 28L | Trim always operable (15) | LL, LP, LB | | | |
| 28N | Key operates lever (06) | LL, LP, LB | | | |
| 28C | Key locks/Unlocks trim (13) | OB | | | |
| 28K | Key retracts latchbolt (04) | OB | \$230.00 | | |
| 28L | Trim always operable (15) | OB | | | |
| 810 | Dummy Trim (pull) | GTB | | \$100.00 | |
| 802 | Blank Plate | GTB | | \$97.00 | |
| 814 | Key retracts latchbolt (pull) | HTB | | \$197.00 | |
| <u>Thumbpiece Trim</u> | | | | EN/EB/EAB | |
| 810 | Dummy Trim | TP | | \$133.00 | |
| 866 | Key locks/unlocks thumbpiece | TP | | \$319.00 | |
| 814 | Key retracts latch | TP | | \$291.00 | |
| 828 | Trim always operable | TP | | \$164.00 | |
| <u>Thru Bolt Application</u> | | Pack Part # | | Finish | |
| | | No. Bolts per Pack | 1-3/4" Dr. | 2-1/4" Dr. | |
| 3828, 12-3828 | | 4 | 28-2024 | 28-2025 | \$27.00 Pack |
| 3727 | | 14 | 28-2031 | 28-2032 | \$96.00 Pack |
| 12-3727 | | 16 | 28-2087 | 28-2088 | \$109.00 Pack |

ED-6 EXIT DEVICES

SARGENT®

ASSA ABLOY

9898 SERIES OPTIONS

USA & Canada Prices Effective June 3, 2019

| Options | Description | Price |
|---------|---|----------------|
| 10 | SARGENT Signature System | \$58.00 /cyl. |
| 11 | SARGENT XC Key System (not available w/10, 22, KESO, SC, & SE options) | No addition |
| 1160 | SARGENT XC Large Format Interchangeable Plastic Disposable Construction Core | No addition |
| 1163 | SARGENT XC Large Format Interchangeable Core Cylinder – Includes masterkeying charges | \$77.00 |
| 1164 | SARGENT XC Large Format Interchangeable Construction Core Cylinder | \$77.00 |
| 21 | SARGENT Construction Key System (lost ball) | \$16.00 /cyl. |
| 22 | SARGENT Construction Key System (split key) | \$32.00 /cyl. |
| 42 | Reinforced Crossbar | \$71.00 |
| 60 | SARGENT Large Format Interchangeable Plastic Disposable Construction Core | No addition |
| 63 | SARGENT Large Format IC Cylinder includes master and grandmaster keying charge | \$77.00 /cyl. |
| 64 | SARGENT Large Format Interchangeable Construction Core Cylinder | \$77.00 |
| 81 | Cylinder to accept Keso (83) and Keso F1 (F183) removable core – no core provided | No addition |
| F182 | SARGENT Keso Security, patent pending, cylinder – new key systems | \$84.00 /cyl. |
| F183 | SARGENT Keso Security, patent pending, removable core cylinder – new key systems | \$120.00 /cyl. |
| 82 | SARGENT Keso Security Cylinder (existing key systems only) | \$84.00 /cyl. |
| 83 | SARGENT Keso Security Removable Core Cylinder (existing key systems only) | \$120.00 /cyl. |
| 84 | SARGENT Keso Security Removable Construction Core Cylinder | See CK-18 |
| BR | SARGENT Bump Resistant Cylinders (not available w/10, 22, 30, 60, 63, 64, 70, 72, 73, 737P, KESO, SC, SE) | \$23.00 /cyl. |
| CPC | Clear Powder Coat – Recommended for exit devices used in full exterior application and highly corrosive areas with 32 and 32D finishes. | \$214.00 |
| DG1 | Patented Degree DG1 Key System | No Addition |
| DG160 | Hardware prepared for DG1-6300 Lg. Format IC cores, supplied with temporary plastic construction cores | No addition |
| DG163 | Patented Degree DG1 Large Format Interchangeable Core Cylinder - Includes master keying charges | \$77.00 |
| DG164 | Hardware prepared for DG1-6300 Lg. Format IC cores, supplied with temporary keyed construction cores | \$77.00 |
| DG2 | Patented Degree DG2 Key System incorporating a locking sidebar | \$58.00/cyl. |
| DG260 | Hardware prepared for DG2-6300 Lg. Format IC cores, supplied with temporary plastic construction cores | No addition |
| DG263 | Patented Degree DG2 Large Format Interchangeable Core Cylinder - Includes master keying charges | \$135.00 |
| DG264 | Hardware prepared for DG2-6300 Lg. Format IC cores, supplied with temporary keyed construction cores | \$77.00 |
| DG3 | Patented Degree DG3 Key System incorporating a locking sidebar and UL437 listed | \$82.00/cyl. |
| DG360 | Hardware prepared for DG3-6300 Lg. Format IC cores, supplied with temporary plastic construction cores | No addition |
| DG363 | Patented Degree DG3 Large Format Interchangeable Core Cylinder - Includes master keying charges | \$159.00 |
| DG364 | Hardware prepared for DG3-6300 Lg. Format IC cores, supplied with temporary keyed construction cores | \$77.00 |
| SG | MicroShield® an antimicrobial powder coat (Not Available with 10B finish) | \$82.00 |
| TB | Thru-bolt | \$24.00 |

Notes:

Center Bearing Bracket for door 48" and over, order using part 98-2162 x finish \$390.36

9898 REVERSIBLE RIM DEVICE

USA & Canada Prices Effective June 3, 2019

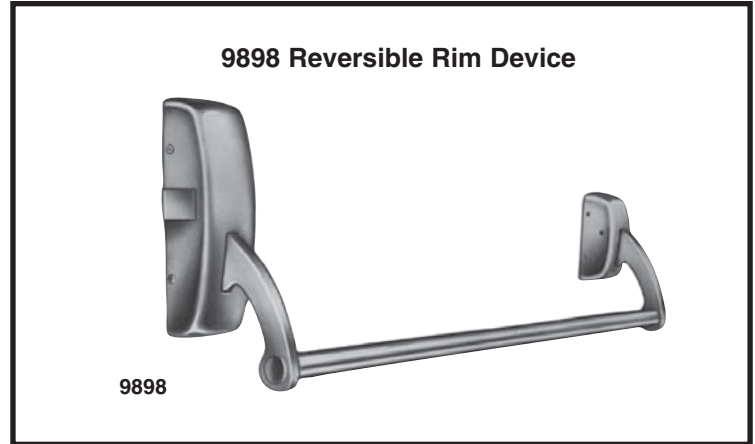

| <u>Less Trim</u> | | <u>Finish</u> | |
|------------------|------------------|-----------------------------|--|
| Device | 10BE/32D/BSP/WSP | 03/04/09/10/10B/10BL/20D/32 | |
| 9898 | \$1,723.00 | \$2,229.00 | |

| <u>9898 Series Trim</u> | | | <u>All Finishes</u> |
|-------------------------|----------|-------------------------------|---------------------|
| Function | Trim | Description | |
| 802 | PTB | Blank Plate | \$287.00 |
| 810 | PTB, STS | Dummy Trim | |
| 814 | PTB, STS | Key retracts latchbolt | \$423.00 |
| 866 | PTB, STS | Key locks/Unlocks thumb piece | |

8300 SERIES OPTIONS

USA & Canada Prices Effective June 3, 2019



| Options | Description | Price |
|---------|---|---|
| 10 | SARGENT Signature System | \$58.00 / cyl. |
| 11 | SARGENT XC Key System (not available w/10, 22, KESO, SC, & SE options) | No addition |
| 1160 | SARGENT XC Large Format Interchangeable Plastic Disposable Construction Core | No addition |
| 1163 | SARGENT XC Large Format Interchangeable Core Cylinder – Includes masterkeying charges | \$77.00 |
| 1164 | SARGENT XC Large Format Interchangeable Construction Core Cylinder | \$77.00 |
| 1170 | Small Format interchangeable disposable construction core - to accept 7 Pin XC permanent core | No addition |
| 11727P | Small Format interchangeable keyed construction core - to accept 7 Pin XC permanent core | \$69.00 |
| 11737P | Small Format interchangeable core - to accept 7 pin XC permanent core | \$69.00 / cyl. |
| 12 | UL Fire Label Exit Devices (not available with 16- & HK options) | \$177.00 |
| 16 | Cylinder lockdown feature in rail (not available with 12-, 57-, 59-, AL- options) | \$123.00 |
| 19 | 80 Series pushbar without Lexan touchpad | No addition |
| 21 | SARGENT Construction Key System (lost ball) | \$16.00 / cyl. |
| 22 | SARGENT Construction Key System (split key) | \$32.00 / cyl. |
| 23 | ANSI flat lip strike (8300, 8900, 9900, Including 12-Option) | No addition |
| 31 | For doors greater than 1-3/4" and up to 2-1/4" (including those with auxiliary controls) For doors over 2-1/4" For doors with panels (See catalog for ordering details) | No addition Consult Factory No addition |
| 36 | 6 Lobe security head screws | \$45.00 |
| 37 | Spanner head screws | \$29.00 |
| 43 | Flush End Cap | No addition |
| * 53 | Latchbolt Monitor Switch – available with 55, 56, 57, 58, AL options) | \$237.00 |
| 54 | Internal Micro Switch in ET Control | \$214.00 |
| * 55 | Signal Switch in Rail | \$223.00 |
| * 56 | Remote Dogging / Latch Retraction (Minimum door width for narrow stile is 26" and wide stile is 28") | \$835.00 |
| * HK56 | Latch Retraction with Hex Key Dogging | \$835.00 |
| * 57 | Delayed Action(Magnet ordered separate) | \$1,302.00 |
| * 58 | Electric Dogging | \$450.00 |
| * 59 | Electroguard (Not available with HC-, 16-, 53-, 55-, 56-, 57-, 58- Options) | \$1,593.00 |
| * BC59 | Electroguard Boca Code (Needs Door Status Switch), (Not available with HC-, 16-, 53-, 55-, 56-, 57-, 58- Options) | \$1,695.00 |
| 60 | SARGENT Large Format Interchangeable Plastic Disposable Construction Core | No addition |
| 63 | SARGENT Large Format Interchangeable Core Cylinder includes master and grandmaster keying charge | \$77.00 / cyl. |
| 64 | SARGENT Large Format Interchangeable Construction Core Cylinder | \$77.00 |
| 6573 | Small Format 6 Pin Uncombined Core | \$59.00 / cyl. |
| 65737P | Small Format 7 Pin Uncombined Core | \$59.00 / cyl. |
| 70 | Small Format Interchangeable Disposable plastic construction core | No addition |
| 72 | Small Format Interchangeable 6-Pin Construction Core (7-pin with 11 option) | \$69.00 |
| 73 | Small Format 6-pin interchangeable core | \$69.00 / cyl. |
| 737P | Small Format 7-pin interchangeable core, | \$69.00 / cyl. |
| 76 | Tactile Warning - Milled Outside Lever (Not available with Studio, Coastal and the A Levers) | \$71.00 |
| 81 | Cylinder to accept Keso (83) and Keso F1 (F183) removable core – no core provided | No addition |
| F182 | SARGENT Keso Security, patent pending, cylinder – new key systems | \$84.00 / cyl. |
| F183 | SARGENT Keso Security, patent pending, removable core cylinder – new key systems | \$120.00 / cyl. |
| 82 | SARGENT Keso Security Cylinder (existing key systems only) | \$84.00 / cyl. |
| 83 | SARGENT Keso Security Removable Core Cylinder (existing key systems only) | \$120.00 / cyl. |
| 84 | SARGENT Keso Security Removable Construction Core Cylinder | See CK-18 |
| 85 | Tactile Warning - Abrasive Strip Inside Push Rail | \$93.00 |
| 86 | Tactile Warning - Abrasive Coating Outside Lever | \$43.00 |
| 87 | Tactile Warning - Abrasive Strip on Inside Push Rail & Coating on Outside Lever | \$136.00 |
| * AL | Alarmed (not available with 16-, 56- thru 59- options) (minimum Dr width 36") | \$550.00 |
| BR | SARGENT Bump Resistant Cylinders (N/A w/10, 22, 30, 60, 63, 64, 70, 72, 73, 737P, KESO, SC, SE) | \$23.00 /cyl. |
| CPC | Clear Powder Coat – Recommended for exit devices used in full exterior application and highly corrosive areas with 32 and 32D finishes. | \$214.00 |
| DG1 | Patented Degree DG1 Key System | No Addition |
| DG160 | Hardware prepared for DG1-6300 Lg. Format IC cores, supplied with temporary plastic construction cores | No addition |
| DG163 | Patented Degree DG1 Large Format Interchangeable Core Cylinder - Includes master keying charges | \$77.00 |
| DG164 | Hardware prepared for DG1-6300 Lg. Format IC cores, supplied with temporary keyed construction cores | \$77.00 |
| DG2 | Patented Degree DG2 Key System incorporating a locking sidebar | \$58.00/cyl. |
| DG260 | Hardware prepared for DG2-6300 Lg. Format IC cores, supplied with temporary plastic construction cores | No addition |
| DG263 | Patented Degree DG2 Large Format Interchangeable Core Cylinder - Includes master keying charges | \$135.00 |
| DG264 | Hardware prepared for DG2-6300 Lg. Format IC cores, supplied with temporary keyed construction cores | \$77.00 |
| DG3 | Patented Degree DG3 Key System incorporating a locking sidebar and UL437 listed | \$82.00/cyl. |
| DG360 | Hardware prepared for DG3-6300 Lg. Format IC cores, supplied with temporary plastic construction cores | No addition |
| DG363 | Patented Degree DG3 Large Format Interchangeable Core Cylinder - Includes master keying charges | \$159.00 |
| DG364 | Hardware prepared for DG3-6300 Lg. Format IC cores, supplied with temporary keyed construction cores | \$77.00 |
| LC | Less Cylinder | -\$89.00/cyl. |
| LD | Less Dogging | No addition |
| * PL | SARGuide™ PL – Photoluminescent Coating – (Pushbar w/o Lexan Touchpad - 19 option is supplied as standard) | \$348.00 |
| SC | Schlage C Keyway Cylinder 0 Bitted (Rim and # 41 Mortise Cylinder Only) | No addition |
| SE | Schlage E Keyway Cylinder 0 Bitted (Rim and # 41 Mortise Cylinder Only) | No addition |
| SG | MicroShield® an antimicrobial powder coat (not available with 10B) | \$82.00 |
| TB | Thru Bolt | \$24.00 |
| * TL | SARGuide™ – Illuminated Touchpad (not available AL, 57, 59 options) | \$214.00 |

NOTES: FLW NOT available in stainless steel. Cylinders not included when ordered less trim.

* Exact door width required when ordering.

USA & Canada Prices Effective June 3, 2019



| 8300 Series-Narrow Stile Mortise Device | | |
|---|---|---|
|  ET Control |  ET Control |  PTB |
| Standard Levers: A-B-E-F-J-L-P-W Coastal Levers: G-R-S-Y All Studio Collection Levers (Except Gramercy, Wooster Square, & Grant Park) | Gramercy Series: RAG-RAL-RAM-RAS-RCM-REM-RGM Wooster Square: H001-H002-H003-H004-H005-H006 Grant Park: H007-H008-H009-H010-H011 | STS-MAL-FLL-FLW |
| Finishes listed below are for the exit device. Refer to catalog for available trims, trim finishes and how to order. | | |

| 8300 Series | | Finish | | | | | |
|--|---|----------------------|---------------------------------|----------------------|---------------------------------|----------------------|---------------------------------|
| Function | Description | 10BE/32D/ BSP/WSP | 03/04/09/10/10B/ 10BL/20D/32 | 10BE/32D/ BSP/WSP | 03/04/09/10/10B/ 10BL/20D/32 | 10BE/32D/ BSP/WSP | 03/04/09/10/10B/ 10BL/20D/32 |
| 8310 | Exit Only / No Trim | \$2,490.00 | \$2,629.00 | | | | |
| 8310 | Dummy Trim (Lever rigid) | | | | | | |
| 8304 | Key Retracts Latchbolt (Lever rigid)* | \$3,187.00 | \$3,326.00 | \$3,410.00 | \$3,549.00 | \$2,913.00 | \$3,052.00 |
| 8313 | Key locks/unlocks control | | | | | | |
| 8315 | Trim always operable | | | | | | |
| 8328 | Thumb piece always operable | | | | | | |
| 8363 | Key locks/unlocks thumb piece | | | | | \$2,983.00 | \$3,122.00 |
| 8300 Series With Freewheeling Trim | | | | | | | |
| 8340 | Dummy Trim (Lever rotates) | | | | | | |
| 8343 | Key engages/disengages lever | \$3,187.00 | \$3,326.00 | \$3,410.00 | \$3,549.00 | | |
| 8344 | Key retracts latchbolt (Lever rotates)* | | | | | | |
| 8300 Series With Electro-Mechanical | | | | | | | |
| 8373 | Fail Safe 12v or 24v* | \$3,473.00 | \$3,612.00 | \$3,650.00 | \$3,789.00 | | |
| 8374 | Fail Secure 12v or 24v* | | | | | | |
| 8375 | Fail Safe 12v or 24v* | \$3,708.00 | \$3,847.00 | \$3,876.00 | \$4,015.00 | | |
| 8376 | Fail Secure 12v or 24v* | | | | | | |

Specify voltage required when ordering.

| Thru Bolt Application | Pack Part # | | Finish | |
|-----------------------|--------------------|------------|------------|---|
| | No. Bolts per Pack | 1-3/4" Dr. | 2-1/4" Dr. | 03/04/09/10/10B/10BE/10BL/20D/26D/BSP/WSP |
| 8300, 12-8300 | 4 | 68-2521 | 68-2570 | \$24.00 Pack |

NOTES:

*Not available with Arrow, Best, Falcon Interchangeable core options, SC and SE on ET trim cylinders.

FLW is not available in 32 & 32D finish.

Cylinders not included when ordered less trim except for 04 function.

15 or 26D finishes are available on outside trim only, the exit devices will be supplied in 32D.

14 or 26 Finishes are available on outside trim only, the exit devices will be supplied in 32 finish.

AD8400 SERIES OPTIONS

USA & Canada Prices Effective June 3, 2019

| Options | Description | Price |
|---------|---|-----------------|
| 10 | SARGENT Signature System | \$58.00 / cyl. |
| 11 | SARGENT XC Key System (not available w/10, 22, KESO, SC, & SE options) | No addition |
| 1160 | SARGENT XC Large Format Interchangeable Plastic Disposable Construction Core | No addition |
| 1163 | SARGENT XC Large Format Interchangeable Core Cylinder – Includes masterkeying charges | \$77.00 |
| 1164 | SARGENT XC Large Format Interchangeable Construction Core Cylinder | \$77.00 |
| 1170 | Small Format interchangeable disposable construction core - to accept 7 Pin XC permanent core | No addition |
| 11727P | Small Format interchangeable keyed construction core - to accept 7 Pin XC permanent core | \$69.00 |
| 11737P | Small Format interchangeable core - to accept 7 pin XC permanent core | \$69.00 / cyl. |
| 16 | Cylinder lockdown feature in rail (not available with 57-, 59-, AL- options) | \$123.00 |
| 19 | 80 Series pushbar without Lexan touchpad | No addition |
| 21 | SARGENT Construction Key System (lost ball) | \$16.00 / cyl. |
| 22 | SARGENT Construction Key System (split key) | \$32.00 / cyl. |
| 31 | For doors greater than 1-3/4" and up to 2-1/4" (including those with auxiliary controls) | No addition |
| | For doors over 2-1/4" | Consult Factory |
| | For doors with panels (See catalog for ordering details) | No addition |
| 36 | 6 Lobe security head screws | \$60.00 |
| 37 | Spanner head screws | \$42.00 |
| 43 | Flush End Cap | No addition |
| * 53 | Latchbolt Monitor Switch – available with 55, 56, 57, 58, AL options) | \$237.00 |
| 54 | Internal Micro Switch in ET Control | \$214.00 |
| * 55 | Signal Switch in Rail | \$223.00 |
| * 56 | Remote Dogging / Latch Retraction (Minimum door width for narrow stile is 26" and wide stile is 28") | \$835.00 |
| * HK56 | Latch Retraction with Hex Key Dogging | \$835.00 |
| * 57 | Delayed Action (Magnet ordered separate) | \$1,302.00 |
| * 58 | Electric Dogging | \$450.00 |
| * 59 | Electroguard (Not available with HC, 16, 53, 55, 56, 57, 58, NB options) | \$1,593.00 |
| * BC59 | Electroguard Boca Code (Needs Door Status Switch) (Not available with HC, 16, 53, 55, 56, 57, 58, NB options) | \$1,695.00 |
| 60 | SARGENT Large Format Interchangeable Plastic Disposable Construction Core | No addition |
| 63 | SARGENT Large Format Interchangeable Core Cylinder includes master and grandmaster keying charge | \$77.00 / cyl. |
| 64 | SARGENT Large Format Interchangeable Construction Core Cylinder | \$77.00 |
| 6573 | Small Format 6 Pin Uncombined Core | \$59.00 / cyl. |
| 65737P | Small Format 7 Pin Uncombined Core | \$59.00 / cyl. |
| 70 | Small Format Interchangeable Disposable plastic construction core | No addition |
| 72 | Small Format Interchangeable 6-Pin Construction Core (7-pin with 11 option) | \$69.00 |
| 73 | Small Format 6-pin interchangeable core | \$69.00 / cyl. |
| 737P | Small Format 7-pin interchangeable core | \$69.00 / cyl. |
| 76 | Tactile Warning - Milled Outside Lever (Not available with Studio, Coastal and the A Levers) | \$71.00 |
| 81 | Cylinder to accept Keso (83) and Keso F1 (F183) removable core – no core provided | No addition |
| F182 | SARGENT Keso Security, patent pending, cylinder – new key systems | \$84.00 / cyl. |
| F183 | SARGENT Keso Security, patent pending, removable core cylinder – new key systems | \$120.00 / cyl. |
| 82 | SARGENT Keso Security Cylinder (existing key systems only) | \$84.00 / cyl. |
| 83 | SARGENT Keso Security Removable Core Cylinder (existing key systems only) | \$120.00 / cyl. |
| 84 | SARGENT Keso Security Removable Construction Core Cylinder | See CK-18 |
| 85 | Tactile Warning - Abrasive Strip Inside Push Rail | \$93.00 |
| 86 | Tactile Warning - Abrasive Coating Outside Lever | \$43.00 |
| 87 | Tactile Warning - Abrasive Strip on Inside Push Rail & Coating on Outside Lever | \$136.00 |
| * AL | Alarmed (not available with 16-, 56- thru 59- options) (minimum Dr width 36") | \$550.00 |
| BR | SARGENT Bump Resistant Cylinders (N/A w/10, 22, 30, 60, 63, 64, 70, 72, 73, 737P, KESO, SC, SE) | \$23.00 / cyl. |
| CPC | Clear Powder Coat – Recommended for exit devices used in full exterior application and highly corrosive areas with 32 and 32D finishes. | \$214.00 |
| DG1 | Patented Degree DG1 Key System | No Addition |
| DG160 | Hardware prepared for DG1-6300 Lg. Format IC cores, supplied with temporary plastic construction cores | No addition |
| DG163 | Patented Degree DG1 Large Format Interchangeable Core Cylinder - Includes master keying charges | \$77.00 |
| DG164 | Hardware prepared for DG1-6300 Lg. Format IC cores, supplied with temporary keyed construction cores | \$77.00 |
| DG2 | Patented Degree DG2 Key System incorporating a locking sidebar | \$58.00/cyl. |
| DG260 | Hardware prepared for DG2-6300 Lg. Format IC cores, supplied with temporary plastic construction cores | No addition |
| DG263 | Patented Degree DG2 Large Format Interchangeable Core Cylinder - Includes master keying charges | \$135.00 |
| DG264 | Hardware prepared for DG2-6300 Lg. Format IC cores, supplied with temporary keyed construction cores | \$77.00 |
| DG3 | Patented Degree DG3 Key System incorporating a locking sidebar and UL437 listed | \$82.00/cyl. |
| DG360 | Hardware prepared for DG3-6300 Lg. Format IC cores, supplied with temporary plastic construction cores | No addition |
| DG363 | Patented Degree DG3 Large Format Interchangeable Core Cylinder - Includes master keying charges | \$159.00 |
| DG364 | Hardware prepared for DG3-6300 Lg. Format IC cores, supplied with temporary keyed construction cores | \$77.00 |
| LC | Less Cylinder | -\$89.00/cyl. |
| LD | Less Dogging | No addition |
| * PL | SARGuide™ PL – Photoluminescent Coating – (Pushbar w/o Lexan Touchpad - 19 option is supplied as standard) | \$348.00 |
| NB | No Bottom Rod (Not available with 59 and BC59 option) | No addition |
| SC | Schlage C Keyway Cylinder 0-Bitted (Rim and #41 Mortise Cylinder Only) | No addition |
| SE | Schlage E Keyway Cylinder 0-Bitted (Rim and #41 Mortise Cylinder Only) | No addition |
| SG | MicroShield® an antimicrobial powder coat (not available with 10B) | \$82.00 |
| * TL | SARGuide™ – Illuminated Touchpad (not available with AL, 57, 59 options) | \$214.00 |



*** Exact door width required when ordering.**

| | |
|---|-------------|
| Vertical Rod Device to 96" Height | No addition |
| Concealed/Surface Vertical Rod Device over 96" to 120" Height | \$60.00 |

Refer to catalog for max. door height availability on fire rated exit devices.

USA & Canada Prices Effective June 3, 2019



| 8400 Series-Narrow Stile Concealed Vertical Rod | | |
|---|---|--|
|  ET Control |  ET Control |  |
| Standard Levers: A-B-E-F-J-L-P-W Coastal Levers: G-R-S-Y All Studio Collection Levers (Except Gramercy, Wooster Square, & Grant Park) | Gramercy Series: RAG-RAL-RAM-RAS-RCM-REM-RGM Wooster Square: H001-H002-H003-H004-H005-H006 Grant Park: H007-H008-H009-H010-H011 | Auxiliary Control (106/113) with 862, 863, 864 Pull Price includes 862 Pull (shown) |
| Finishes listed below are for the exit device. Refer to catalog for available trims, trim finishes and how to order. | | |

| 8400 Series | | | Finish | | | | | |
|-------------|----------|--------------------------|----------------------|---------------------------------|----------------------|---------------------------------|---------------------|----------------------|
| Option | Function | Description | 10BE/32D/ BSP/WSP | 03/04/09/10/10B/ 10BL/20D/32 | 10BE/32D/ BSP/WSP | 03/04/09/10/10B/ 10BL/20D/32 | 10BE/32D BSP/WSP | 03/04/10/ 10B/ 32 |
| AD | 8410 | Exit Only No Trim | \$2,805.00 | \$2,947.00 | | | | |
| AD | 8410 | Dummy Trim (Lever rigid) | \$3,502.00 | \$3,644.00 | \$3,725.00 | \$3,867.00 | \$3,075.00 | \$3,238.00 |
| AD | 8410* | Key operates control | | | | | \$3,772.00 | \$3,935.00 |
| AD | 8406 | Key operates ET | | | | | | |
| AD | 8413 | Key locks/unlocks ET | \$3,502.00 | \$3,644.00 | \$3,725.00 | \$3,867.00 | | |
| AD | 8415 | Trim always operable | | | | | | |

*When ordering Exits with Auxiliary Control, please order as follows: example: 8410F x 106/113 x 862 x 32D x RHR

| 8400 Series With Freewheeling Trim | | | | | | | | |
|------------------------------------|------|------------------------------|------------|------------|------------|------------|--|--|
| AD | 8440 | Dummy Trim (Lever rotates) | | | | | | |
| AD | 8443 | Key engages/disengages lever | \$3,502.00 | \$3,644.00 | \$3,725.00 | \$3,867.00 | | |
| AD | 8446 | Key operates control | | | | | | |

| 8400 Series With Electro-Mechanical | | | | | | | | |
|-------------------------------------|------|------------------------|------------|------------|------------|------------|--|--|
| AD | 8473 | Fail Safe 12v or 24v | \$3,788.00 | \$3,930.00 | \$3,965.00 | \$4,107.00 | | |
| AD | 8474 | Fail Secure 12v or 24v | | | | | | |

Note: Specify voltage required when ordering.

863 (18" x 1" Diameter) Pull provided in lieu of 862 (10" x 1" Diameter) Add \$66.00

864 (10" x 3/4" Diameter) Pull provided in lieu of 862 (10" x 1" Diameter) Deduct \$35.00

NOTES:

▶ Dummy Trim includes pull only, auxiliary control not supplied.

Thru Bolt application not available.

Cylinders not included when ordered less trim.

15 or 26D finishes are available on outside trim only, the exit devices will be supplied in 32D.

14 or 26 Finishes are available on outside trim only, the exit devices will be supplied in 32 finish.



MD8400 SERIES OPTIONS

USA & Canada Prices Effective June 3, 2019

| Options | Description | Price |
|--|---|-----------------|
| 10 | SARGENT Signature System | \$58.00 / cyl. |
| 11 | SARGENT XC Key System (not available w/10, 22, KESO, SC, & SE options) | No addition |
| 12 | UL Fire Label Exit Devices (not available with 16- & HK options) | \$177.00 |
| 1160 | SARGENT XC Large Format Interchangeable Plastic Disposable Construction Core | No addition |
| 1163 | SARGENT XC Large Format Interchangeable Core Cylinder – Includes masterkeying charges | \$77.00 |
| 1164 | SARGENT XC Large Format Interchangeable Construction Core Cylinder | \$77.00 |
| 1170 | Small Format interchangeable disposable construction core - to accept 7 Pin XC permanent core | No addition |
| 11727P | Small Format interchangeable keyed construction core - to accept 7 Pin XC permanent core | \$69.00 |
| 11737P | Small Format interchangeable core - to accept 7 pin XC permanent core | \$69.00 / cyl. |
| 16 | Cylinder lockdown feature in rail (not available with 12-, 57-, 59-, AL- options) | \$123.00 |
| 19 | 80 Series pushbar without Lexan touchpad | No addition |
| 21 | SARGENT Construction Key System (lost ball) | \$16.00 / cyl. |
| 22 | SARGENT Construction Key System (split key) | \$32.00 / cyl. |
| 31 | For doors greater than 1-3/4" and up to 2-1/4" (including those with auxiliary controls) | No addition |
| | For doors over 2-1/4" | Consult Factory |
| | For doors with panels (See catalog for ordering details) | No addition |
| 36 | 6 Lobe security head screws | \$60.00 |
| 37 | Spanner head screws | \$42.00 |
| 43 | Flush End Cap | No addition |
| * 53 | Latchbolt Monitor Switch – available with 55, 56, 57, 58, AL options | \$237.00 |
| 54 | Internal Micro Switch in ET Control | \$214.00 |
| * 55 | Signal Switch in Rail | \$223.00 |
| * 56 | Remote Dogging / Latch Retraction (Minimum door width for narrow stile is 26" and wide stile is 28") | \$835.00 |
| * HK56 | Latch Retraction with Hex Key Dogging | \$835.00 |
| * 57 | Delayed Action (Magnet ordered separate) | \$1,302.00 |
| * 58 | Electric Dogging | \$450.00 |
| * 59 | Electroguard (Not available with HC, 16, 53, 55, 56, 57, 58, NB options) | \$1,593.00 |
| * BC59 | Electroguard Boca Code (Needs Door Status Switch) (Not available with HC, 16, 53, 55, 56, 57, 58, NB options) | \$1,695.00 |
| 60 | SARGENT Large Format Interchangeable Plastic Disposable Construction Core | No addition |
| 63 | SARGENT Large Format Interchangeable Core Cylinder includes master and grandmaster keying charge | \$77.00 /cyl. |
| 64 | SARGENT Large Format Interchangeable Construction Core Cylinder | \$77.00 |
| 6573 | Small Format 6 Pin Uncombined Core | \$59.00 / cyl. |
| 65737P | Small Format 7 Pin Uncombined Core | \$59.00 / cyl. |
| 70 | Small Format Interchangeable Disposable plastic construction core | No addition |
| 72 | Small Format Interchangeable 6-Pin Construction Core (7-pin with 11 option) | \$69.00 |
| 73 | Small Format 6-pin interchangeable core | \$69.00 / cyl. |
| 737P | Small Format 7-pin interchangeable core | \$69.00 / cyl. |
| 76 | Tactile Warning - Milled Outside Lever (Not available with Studio, Coastal and the A Levers) | \$71.00 |
| 81 | Cylinder to accept Keso (83) and Keso F1 (F183) removable core – no core provided | No addition |
| F182 | SARGENT Keso Security, patent pending, cylinder – new key systems | \$84.00 / cyl. |
| F183 | SARGENT Keso Security, patent pending, removable core cylinder – new key systems | \$120.00 / cyl. |
| 82 | SARGENT Keso Security Cylinder (existing key systems only) | \$84.00 / cyl. |
| 83 | SARGENT Keso Security Removable Core Cylinder (existing key systems only) | \$120.00 / cyl. |
| 84 | SARGENT Keso Security Removable Construction Core Cylinder | See CK-18 |
| 85 | Tactile Warning - Abrasive Strip Inside Push Rail | \$93.00 |
| 86 | Tactile Warning - Abrasive Coating Outside Lever | \$43.00 |
| 87 | Tactile Warning - Abrasive Strip on Inside Push Rail & Coating on Outside Lever | \$136.00 |
| * AL | Alarmed (not available with 56- thru 59- options) (minimum Dr width 36") | \$550.00 |
| BR | SARGENT Bump Resistant Cylinders (N/A w/10, 22, 30, 60, 63, 64, 70, 72, 73, 737P, KESO, SC, SE) | \$23.00 /cyl. |
| CPC | Clear Powder Coat – Recommended for exit devices used in full exterior application and highly corrosive areas with 32 and 32D finishes. | \$214.00 |
| DG1 | Patented Degree DG1 Key System | No Addition |
| DG160 | Hardware prepared for DG1-6300 Lg. Format IC cores, supplied with temporary plastic construction cores | No addition |
| DG163 | Patented Degree DG1 Large Format Interchangeable Core Cylinder - Includes master keying charges | \$77.00 |
| DG164 | Hardware prepared for DG1-6300 Lg. Format IC cores, supplied with temporary keyed construction cores | \$77.00 |
| DG2 | Patented Degree DG2 Key System incorporating a locking sidebar | \$58.00/cyl. |
| DG260 | Hardware prepared for DG2-6300 Lg. Format IC cores, supplied with temporary plastic construction cores | No addition |
| DG263 | Patented Degree DG2 Large Format Interchangeable Core Cylinder - Includes master keying charges | \$135.00 |
| DG264 | Hardware prepared for DG2-6300 Lg. Format IC cores, supplied with temporary keyed construction cores | \$77.00 |
| DG3 | Patented Degree DG3 Key System incorporating a locking sidebar and UL437 listed | \$82.00/cyl. |
| DG360 | Hardware prepared for DG3-6300 Lg. Format IC cores, supplied with temporary plastic construction cores | No addition |
| DG363 | Patented Degree DG3 Large Format Interchangeable Core Cylinder - Includes master keying charges | \$159.00 |
| DG364 | Hardware prepared for DG3-6300 Lg. Format IC cores, supplied with temporary keyed construction cores | \$77.00 |
| LC | Less Cylinder | -\$89.00/cyl. |
| LD | Less Dogging | No addition |
| NB | No Bottom Rod (Not available with 59 and BC59 option) | No addition |
| * PL | SARGuide™ PL – Photoluminescent Coating – (Pushbar w/o Lexan Touchpad - 19 option is supplied as standard) | \$348.00 |
| SC | Schlage C Keyway Cylinder 0-Bitted (Rim and #41 Mortise Cylinder Only) | No addition |
| SE | Schlage E Keyway Cylinder 0-Bitted (Rim and #41 Mortise Cylinder Only) | No addition |
| SG | MicroShield® an antimicrobial powder coat (not available with 10B) | \$82.00 |
| * TL | SARGuide™ – Illuminated Touchpad (not available with AL, 57, 59 options) | \$214.00 |
| * Exact door width required when ordering. | | |
| | Vertical Rod Device to 96" Height | No addition |
| | Concealed/Surface Vertical Rod Device over 96" to 120" Height | \$60.00 |
| Refer to catalog for max. door height availability on fire rated exit devices. | | |
| 683 Thermal Pin Kit for use with 45/60/90 Minute Wood Doors | | |
| 683 | | \$97.00 |

USA & Canada Prices Effective June 3, 2019



| MD8400 Series-Narrow Stile Concealed Vertical Rod | | |
|--|---|---|
|  ET Control |  ET Control |  Auxiliary Control (106/113) with 862, 863, 864 Pull |
| Standard Levers: A-B-E-F-J-L-P-W Coastal Levers: G-R-S-Y All Studio Collection Levers (Except Gramercy, Wooster Square, & Grant Park) | Gramercy Series: RAG-RAL-RAM-RAS-RCM-REM-RGM Wooster Square: H001-H002-H003-H004-H005-H006 Grant Park: H007-H008-H009-H010-H011 | Price includes 862 Pull (shown) |
| Finishes listed below are for the exit device. Refer to catalog for available trims, trim finishes and how to order. | | |

| MD8400 Series | | | Finish | | | | | |
|---------------|----------|--------------------------|-------------------|------------------------------|-------------------|------------------------------|-------------------|------------------|
| Option | Function | Description | 10BE/32D/ BSP/WSP | 03/04/09/10/10B/ 10BL/20D/32 | 10BE/32D/ BSP/WSP | 03/04/09/10/10B/ 10BL/20D/32 | 10BE/32D/ BSP/WSP | 03/04/10/ 10B/32 |
| MD | 8410 | Exit Only No Trim | \$2,805.00 | \$2,947.00 | | | | |
| MD | 8410 | Dummy Trim (Lever rigid) | \$3,502.00 | \$3,644.00 | \$3,725.00 | \$3,867.00 | \$3,075.00 | \$3,238.00 |
| MD | 8410* | Key operates control | | | | | \$3,772.00 | \$3,935.00 |
| MD | 8406 | Key operates ET | | | | | | |
| MD | 8413 | Key locks/unlocks ET | \$3,502.00 | \$3,644.00 | \$3,725.00 | \$3,867.00 | | |
| MD | 8415 | Trim always operable | | | | | | |

*When ordering Exits with Auxiliary Control Design, please order as follows: example: 12-MD8410F x 106/113 x 862 x 32D x RHR

| MD8400 With Freewheeling Trim | | | | | | | | |
|--------------------------------|------|------------------------------|------------|------------|------------|------------|--|--|
| MD | 8440 | Dummy Trim (Lever rotates) | | | | | | |
| MD | 8443 | Key engages/disengages lever | \$3,502.00 | \$3,644.00 | \$3,725.00 | \$3,867.00 | | |
| MD | 8446 | Key operates control | | | | | | |
| MD8400 With Electro-Mechanical | | | | | | | | |
| MD | 8473 | Fail Safe 12v or 24v | \$3,788.00 | \$3,930.00 | \$3,965.00 | \$4,107.00 | | |
| MD | 8474 | Fail Secure 12v or 24v | | | | | | |

Note: Specify voltage required when ordering.

| | |
|--|----------------|
| 863 (18" x 1" Diameter) Pull provided in lieu of 862 (10" x 1" Diameter) | Add \$66.00 |
| 864 (10" x 3/4" Diameter) Pull provided in lieu of 862 (10" x 1" Diameter) | Deduct \$35.00 |

NOTES:

- ▶ Dummy Trim includes pull only, auxiliary control not supplied.
- Thru Bolt application not available.
- Cylinders not included when ordered less trim.

15 or 26D finishes are available on outside trim only, the exit devices will be supplied in 32D.

14 or 26 Finishes are available on outside trim only, the exit devices will be supplied in 32 finish.

AD8500 SERIES OPTIONS



USA & Canada Prices Effective June 3, 2019

| Options | Description | Price |
|---------|---|---|
| 10 | SARGENT Signature System | \$58.00 / cyl. |
| 11 | SARGENT XC Key System (not available w/10, 22, KESO, SC, & SE options) | No addition |
| 1160 | SARGENT XC Large Format Interchangeable Plastic Disposable Construction Core | No addition |
| 1163 | SARGENT XC Large Format Interchangeable Core Cylinder – Includes masterkeying charges | \$77.00 |
| 1164 | SARGENT XC Large Format Interchangeable Construction Core Cylinder | \$77.00 |
| 1170 | Small Format interchangeable disposable construction core - to accept 7 Pin XC permanent core | No addition |
| 11727P | Small Format interchangeable keyed construction core - to accept 7 Pin XC permanent core | \$69.00 |
| 11737P | Small Format interchangeable core - to accept 7 pin XC permanent core | \$69.00 / cyl. |
| 12 | UL Fire Label Exit Devices (not available with 16- option) | \$177.00 |
| 16 | Cylinder lockdown feature in rail (not available with 57-, 59-, AL- options) | \$123.00 |
| 19 | 80 Series pushbar without Lexan touchpad | No addition |
| 21 | SARGENT Construction Key System (lost ball) | \$16.00 cyl. |
| 22 | SARGENT Construction Key System (split key) | \$32.00 / cyl. |
| 31 | For doors greater than 1-3/4" and up to 2-1/4" (including those with auxiliary controls) For doors over 2-1/4" For doors with panels (See catalog for ordering details) | No addition Consult Factory No addition |
| 36 | 6 Lobe security head screws | \$36.00 |
| 37 | Spanner head screws | \$25.00 |
| 43 | Flush End Cap | No addition |
| * 53 | Latchbolt Monitor Switch – available with 55, 56, 57, 58, AL option | \$237.00 |
| * 54 | Internal Micro Switch in ET Control | \$214.00 |
| * 55 | Signal Switch in Rail | \$223.00 |
| * 56 | Remote Dogging / Latch Retraction (Minimum door width for narrow stile is 26" and wide stile is 28") | \$835.00 |
| * HK56 | Latch Retraction with Hex Key Dogging | \$835.00 |
| * 57 | Delayed Action (Magnet ordered separate) | \$1,302.00 |
| * 58 | Electric Dogging | \$450.00 |
| 59 | Electroguard (Not available with 16, 53, 55 56, 57, 58, NB prefixes) | \$1,593.00 |
| * BC59 | Electroguard Boca Code (Needs Door Status Switch) (Not available with 16, 53, 55 56, 57, 58, NB prefixes) | \$1,695.00 |
| 60 | SARGENT Large Format Interchangeable Plastic Disposable Construction Core | No addition |
| 63 | SARGENT Large Format Interchangeable Core Cylinder includes master and grandmaster keying charge | \$77.00 /cyl. |
| 64 | SARGENT Large Format Interchangeable Construction Core Cylinder | \$77.00 |
| 6573 | Small Format 6 Pin Uncombined Core | \$59.00 / cyl. |
| 65737P | Small Format 7 Pin Uncombined Core | \$59.00 / cyl. |
| 70 | Small Format Interchangeable Disposable plastic construction core | No addition |
| 72 | Small Format Interchangeable 6-Pin Construction Core (7-pin with 11 option) | \$69.00 |
| 73 | Small Format 6-pin interchangeable core | \$69.00 / cyl. |
| 737P | Small Format 7-pin interchangeable core | \$69.00 / cyl. |
| 76 | Tactile Warning - Milled Outside Lever (Not available with Studio, Coastal and the A Levers) | \$71.00 |
| 81 | Cylinder to accept Keso (83) and Keso F1 (F183) removable core – no core provided | No addition |
| F182 | SARGENT Keso Security, patent pending, cylinder – new key systems | \$84.00 / cyl. |
| F183 | SARGENT Keso Security, patent pending, removable core cylinder – new key systems | \$120.00 / cyl. |
| 82 | SARGENT Keso Security Cylinder (existing key systems only) | \$84.00 / cyl. |
| 83 | SARGENT Keso Security Removable Core Cylinder (existing key systems only) | \$120.00 / cyl. |
| 84 | SARGENT Keso Security Removable Construction Core Cylinder | See CK-18 |
| 85 | Tactile Warning - Abrasive Strip Inside Push Rail | \$93.00 |
| 86 | Tactile Warning - Abrasive Coating Outside Lever | \$43.00 |
| 87 | Tactile Warning - Abrasive Strip on Inside Push Rail & Coating on Outside Lever | \$136.00 |
| * AL | Alarmed (not available with 16-, 56- thru 59- options) (minimum Dr width 36") | \$550.00 |
| BR | SARGENT Bump Resistant Cylinders (N/A w/10, 22, 30, 60, 63, 64, 70, 72, 73, 737P, KESO, SC, SE) | \$23.00 /cyl. |
| CPC | Clear Powder Coat – Recommended for exit devices used in full exterior application and highly corrosive areas with 32 and 32D finishes. | \$214.00 |
| DG1 | Patented Degree DG1 Key System | No Addition |
| DG160 | Hardware prepared for DG1-6300 Lg. Format IC cores, supplied with temporary plastic construction cores | No addition |
| DG163 | Patented Degree DG1 Large Format Interchangeable Core Cylinder - Includes master keying charges | \$77.00 |
| DG164 | Hardware prepared for DG1-6300 Lg. Format IC cores, supplied with temporary keyed construction cores | \$77.00 |
| DG2 | Patented Degree DG2 Key System incorporating a locking sidebar | \$58.00/cyl. |
| DG260 | Hardware prepared for DG2-6300 Lg. Format IC cores, supplied with temporary plastic construction cores | No addition |
| DG263 | Patented Degree DG2 Large Format Interchangeable Core Cylinder - Includes master keying charges | \$135.00 |
| DG264 | Hardware prepared for DG2-6300 Lg. Format IC cores, supplied with temporary keyed construction cores | \$77.00 |
| DG3 | Patented Degree DG3 Key System incorporating a locking sidebar and UL437 listed | \$82.00/cyl. |
| DG360 | Hardware prepared for DG3-6300 Lg. Format IC cores, supplied with temporary plastic construction cores | No addition |
| DG363 | Patented Degree DG3 Large Format Interchangeable Core Cylinder - Includes master keying charges | \$159.00 |
| DG364 | Hardware prepared for DG3-6300 Lg. Format IC cores, supplied with temporary keyed construction cores | \$77.00 |
| GL | Guarded Latch | \$31.00 |
| LC | Less Cylinder | -\$89.00/cyl. |
| LD | Less Dogging | No addition |
| PL | SARGuide™ PL – Photoluminescent Coating – (Pushbar w/o Lexan Touchpad - 19 option is supplied as standard) | \$348.00 |
| SC | Schlage C Keyway Cylinder 0-Bitted (Rim and #41 Mortise Cylinder Only) | No addition |
| SE | Schlage E Keyway Cylinder 0-Bitted (Rim and #41 Mortise Cylinder Only) | No addition |
| SG | MicroShield® an antimicrobial powder coat option (not available with 10B) | \$82.00 |
| TB | Thru Bolt | \$24.00 |
| * TL | SARGuide™ – Illuminated Touchpad (not available with AL, 57, 59 options) | \$214.00 |
| WS | Windstorm Certified (Rim & Mortise Exit Devices only) | No Addition |

* Exact door width required when ordering.

USA & Canada Prices Effective June 3, 2019



| AD8500 Series-Narrow Stile Rim Device | | |
|---|---|--|
|  ET Control |  ET Control |  Cylinder included on keyed functions. |
| Standard Levers: A-B-E-F-J-L-P-W Coastal Levers: G-R-S-Y All Studio Collection Levers (Except Gramercy, Wooster Square, & Grant Park) | Gramercy Series: RAG-RAL-RAM-RAS-RCM-REM-RGM Wooster Square: H001-H002-H003-H004-H005-H006 Grant Park: H007-H008-H009-H010-H011 | 862, 863, 864 Pull Price includes 862 Pull (shown) |
| Finishes listed below are for the exit device. Refer to catalog for available trims, trim finishes and how to order. | | |

| AD8500 Series | | | Finish | | | | | |
|---------------------------------------|----------|--|---------------------|---------------------------------|----------------------|---------------------------------|----------------------|---------------------|
| Option | Function | Description | 10BE/32D BSP/WSP | 03/04/09/10/10B/ 10BL/20D/32 | 10BE/32D/ BSP/WSP | 03/04/09/10/10B/ 10BL/20D/32 | 10BE/32D/ BSP/WSP | 03/04/10/ 10B/32 |
| AD | 8510 | Exit Only No Trim | \$2,063.00 | \$2,155.00 | | | | |
| AD | 8510 | Dummy Trim (Lever rigid) | | | | | \$2,333.00 | \$2,446.00 |
| AD | 8504 | Key retracts latchbolt (Lever rigid) | | | | | | |
| AD | 8506 | Key operates ET | \$2,760.00 | \$2,852.00 | \$2,983.00 | \$3,075.00 | | |
| AD | 8513 | Key locks/unlocks control | | | | | | |
| AD | 8515 | Trim always operable | | | | | | |
| AD8500 Series With Freewheeling Trim | | | | | | | | |
| AD | 8540 | Dummy Trim (Lever rotates) | | | | | | |
| AD | 8543 | Key engages/disengages lever | \$2,760.00 | \$2,852.00 | \$2,983.00 | \$3,075.00 | | |
| AD | 8544 | Key retracts latchbolt (Lever rotates) | | | | | | |
| AD | 8546 | Key operates control | | | | | | |
| AD8500 Series With Electro-Mechanical | | | | | | | | |
| AD | 8573 | Fail Safe 12v or 24v | \$3,046.00 | \$3,138.00 | \$3,223.00 | \$3,315.00 | | |
| AD | 8574 | Fail Secure 12v or 24v | | | | | | |

Note: Specify voltage required when ordering.

863 (18" x 1" Diameter) Pull provided in lieu of 862 (10" x 1" Diameter) Add \$66.00

864 (10" x 3/4" Diameter) Pull provided in lieu of 862 (10" x 1" Diameter) Deduct \$35.00

| Thru Bolt Application | No. Bolts per Pack | Pack Part # | | Finish |
|-----------------------|--------------------|-------------|------------|--------------------------------------|
| | | 1-3/4" Dr. | 2-1/4" Dr. | 03/04/09/10/10B/10BL/20D/26D/BSP/WSP |
| 8500 | 4 | 68-2510 | 68-2511 | \$24.00 Pack |

NOTES: Cylinder not included when ordered less trim except for 04 function.

15 or 26D finishes are available on outside trim only, the exit devices will be supplied in 32D.

14 or 26 Finishes are available on outside trim only, the exit devices will be supplied in 32 finish.

8500 SERIES OPTIONS



USA & Canada Prices Effective June 3, 2019

| Options | Description | Price |
|---------|---|-----------------|
| 10 | SARGENT Signature System | \$58.00 / cyl. |
| 11 | SARGENT XC Key System (not available w/10, 22, KESO, SC, & SE options) | No addition |
| 1160 | SARGENT XC Large Format Interchangeable Plastic Disposable Construction Core | No addition |
| 1163 | SARGENT XC Large Format Interchangeable Core Cylinder – Includes masterkeying charges | \$77.00 |
| 1164 | SARGENT XC Large Format Interchangeable Construction Core Cylinder | \$77.00 |
| 1170 | Small Format interchangeable disposable construction core - to accept 7 Pin XC permanent core | No addition |
| 11727P | Small Format interchangeable keyed construction core - to accept 7 Pin XC permanent core | \$69.00 |
| 11737P | Small Format interchangeable core - to accept 7 pin XC permanent core | \$69.00 / cyl. |
| 12 | UL Fire Label Exit Devices (not available with 16- option) | \$177.00 |
| 16 | Cylinder lockdown feature in rail (not available with 57-, 59-, AL- options) | \$123.00 |
| 19 | 80 Series pushbar without Lexan touchpad | No addition |
| 21 | SARGENT Construction Key System (lost ball) | \$16.00 cyl. |
| 22 | SARGENT Construction Key System (split key) | \$32.00 / cyl. |
| 31 | For doors greater than 1-3/4" and up to 2-1/4" (including those with auxiliary controls) | No addition |
| | For doors over 2-1/4" | Consult Factory |
| | For doors with panels (See catalog for ordering details) | No addition |
| 36 | 6 Lobe security head screws | \$36.00 |
| 37 | Spanner head screws | \$25.00 |
| 43 | Flush End Cap | No addition |
| * 53 | Latchbolt Monitor Switch – available with 55, 56, 57, 58, AL option | \$237.00 |
| * 54 | Internal Micro Switch in ET Control | \$214.00 |
| * 55 | Signal Switch in Rail | \$223.00 |
| * 56 | Remote Dogging / Latch Retraction (Minimum door width for narrow stile is 26" and wide stile is 28") | \$835.00 |
| * HK56 | Latch Retraction with Hex Key Dogging | \$835.00 |
| * 57 | Delayed Action (Magnet ordered separate) | \$1,302.00 |
| * 58 | Electric Dogging | \$450.00 |
| * 59 | Electroguard (Not available with HC-, 16-, 53-, 55-, 56-, 57-, 58- Options) | \$1,593.00 |
| * BC59 | Electroguard Boca Code (Needs Door Status Switch) (Not available with HC-, 16-, 53-, 55-, 56-, 57-, 58- Options) | \$1,695.00 |
| 60 | SARGENT Large Format Interchangeable Plastic Disposable Construction Core | No addition |
| 63 | SARGENT Large Format Interchangeable Core Cylinder includes master and grandmaster keying charge | \$77.00 /cyl. |
| 64 | SARGENT Large Format Interchangeable Construction Core Cylinder | \$77.00 |
| 6573 | Small Format 6 Pin Uncombined Core | \$59.00 / cyl. |
| 65737P | Small Format 7 Pin Uncombined Core | \$59.00 / cyl. |
| 70 | Small Format Interchangeable Disposable plastic construction core | No addition |
| 72 | Small Format Interchangeable 6-Pin Construction Core (7-pin with 11 option) | \$69.00 |
| 73 | Small Format 6-pin interchangeable core | \$69.00 / cyl. |
| 737P | Small Format 7-pin interchangeable core | \$69.00 / cyl. |
| 76 | Tactile Warning - Milled Outside Lever (Not available with Studio, Coastal and the A Levers) | \$71.00 |
| 81 | Cylinder to accept Keso (83) and Keso F1 (F183) removable core – no core provided | No addition |
| F182 | SARGENT Keso Security, patent pending, cylinder – new key systems | \$84.00 / cyl. |
| F183 | SARGENT Keso Security, patent pending, removable core cylinder – new key systems | \$120.00 / cyl. |
| 82 | SARGENT Keso Security Cylinder (existing key systems only) | \$84.00 / cyl. |
| 83 | SARGENT Keso Security Removable Core Cylinder (existing key systems only) | \$120.00 / cyl. |
| 84 | SARGENT Keso Security Removable Construction Core Cylinder | See CK-18 |
| 85 | Tactile Warning - Abrasive Strip Inside Push Rail | \$93.00 |
| 86 | Tactile Warning - Abrasive Coating Outside Lever | \$43.00 |
| 87 | Tactile Warning - Abrasive Strip on Inside Push Rail & Coating on Outside Lever | \$136.00 |
| * AL | Alarmed (not available with 16-, 56- thru 59- options) (minimum Dr width 36") | \$550.00 |
| BR | SARGENT Bump Resistant Cylinders (N/A w/10, 22, 30, 60, 63, 64, 70, 72, 73, 737P, KESO, SC, SE) | \$23.00 /cyl. |
| CPC | Clear Powder Coat – Recommended for exit devices used in full exterior application and highly corrosive areas with 32 and 32D finishes. | \$214.00 |
| DG1 | Patented Degree DG1 Key System | No Addition |
| DG160 | Hardware prepared for DG1-6300 Lg. Format IC cores, supplied with temporary plastic construction cores | No addition |
| DG163 | Patented Degree DG1 Large Format Interchangeable Core Cylinder - Includes master keying charges | \$77.00 |
| DG164 | Hardware prepared for DG1-6300 Lg. Format IC cores, supplied with temporary keyed construction cores | \$77.00 |
| DG2 | Patented Degree DG2 Key System incorporating a locking sidebar | \$58.00/cyl. |
| DG260 | Hardware prepared for DG2-6300 Lg. Format IC cores, supplied with temporary plastic construction cores | No addition |
| DG263 | Patented Degree DG2 Large Format Interchangeable Core Cylinder - Includes master keying charges | \$135.00 |
| DG264 | Hardware prepared for DG2-6300 Lg. Format IC cores, supplied with temporary keyed construction cores | \$77.00 |
| DG3 | Patented Degree DG3 Key System incorporating a locking sidebar and UL437 listed | \$82.00/cyl. |
| DG360 | Hardware prepared for DG3-6300 Lg. Format IC cores, supplied with temporary plastic construction cores | No addition |
| DG363 | Patented Degree DG3 Large Format Interchangeable Core Cylinder - Includes master keying charges | \$159.00 |
| DG364 | Hardware prepared for DG3-6300 Lg. Format IC cores, supplied with temporary keyed construction cores | \$77.00 |
| GL | Guarded Latch | \$31.00 |
| LC | Less Cylinder | -\$89.00/cyl. |
| LD | Less Dogging | No addition |
| PL | SARGuide™ PL – Photoluminescent Coating – (Pushbar w/o Lexan Touchpad - 19 option is supplied as standard) | \$348.00 |
| SC | Schlage C Keyway Cylinder 0-Bitted (Rim and #41 Mortise Cylinder Only) | No addition |
| SE | Schlage E Keyway Cylinder 0-Bitted (Rim and #41 Mortise Cylinder Only) | No addition |
| SG | MicroShield® an antimicrobial powder coat option (not available with 10B) | \$82.00 |
| TB | Thru Bolt | \$24.00 |
| * TL | SARGuide™ – Illuminated Touchpad (not available with AL, 57, 59 options) | \$214.00 |

* Exact door width required when ordering.

USA & Canada Prices Effective June 3, 2019



| 8500 Series-Narrow Stile Rim Device | | |
|---|--|---|
|  ET Control Standard Levers: A-B-E-F-J-L-P-W Coastal Levers: G-R-S-Y All Studio Collection Levers (Except Gramercy, Wooster Square, & Grant Park) |  ET Control Gramercy Series: RAG-RAL-RAM-RAS-RCM-REM-RGM Wooster Square: H001-H002-H003-H004-H005-H006 Grant Park: H007-H008-H009-H010-H011 | Cylinder included on keyed functions.  862, 863, 864 Pull Price includes 862 Pull (shown) |
| Finishes listed below are for the exit device. Refer to catalog for available trims, trim finishes and how to order. | | |

| 8500 Series | | Finish | | | | | |
|-------------------------------------|--|------------|------------------|------------|------------------|------------|------------|
| | | 10BE/32D/ | 03/04/09/10/10B/ | 10BE/32D/ | 03/04/09/10/10B/ | 10BE/32D/ | 03/04/10/ |
| Function Description | | BSP/WSP | 10BL/20D/32 | BSP/WSP | 10BL/20D/32 | BSP/WSP | 10B/32 |
| 8510 | Exit Only No Trim | \$2,063.00 | \$2,155.00 | | | | |
| 8510 | Dummy Trim (Lever rigid) | | | | | \$2,333.00 | \$2,446.00 |
| 8504 | Key retracts latchbolt (Lever rigid) | | | | | | |
| 8506 | Key operates ET | \$2,760.00 | \$2,852.00 | \$2,983.00 | \$3,075.00 | | |
| 8513 | Key locks/unlocks control | | | | | | |
| 8515 | Trim always operable | | | | | | |
| 8500 Series With Freewheeling Trim | | | | | | | |
| 8540 | Dummy Trim (Lever rotates) | | | | | | |
| 8543 | Key engages/disengages lever | | | | | | |
| 8544 | Key retracts latchbolt (Lever rotates) | \$2,760.00 | \$2,852.00 | \$2,983.00 | \$3,075.00 | | |
| 8546 | Key operates control | | | | | | |
| 8500 Series With Electro-Mechanical | | | | | | | |
| 8573 | Fail Safe 12v or 24v | | | | | | |
| 8574 | Fail Secure 12v or 24v | \$3,046.00 | \$3,138.00 | \$3,223.00 | \$3,315.00 | | |

Note: Specify voltage required when ordering.

863 (18" x 1" Diameter) Pull provided in lieu of 862 (10" x 1" Diameter) Add \$66.00

864 (10" x 3/4" Diameter) Pull provided in lieu of 862 (10" x 1" Diameter) Deduct \$35.00

| Thru Bolt Application | Pack Part # | | Finish | |
|-----------------------|--------------------|------------|------------|---|
| | No. Bolts per Pack | 1-3/4" Dr. | 2-1/4" Dr. | 03/04/09/10/10B/10BE/10BL/20D/26D/BSP/WSP |
| 8500 | 4 | 68-2510 | 68-2511 | \$24.00 Pack |

NOTES: Cylinder not included when ordered less trim except for 04 function.

15 or 26D finishes are available on outside trim only, the exit devices will be supplied in 32D.

14 or 26 Finishes are available on outside trim only, the exit devices will be supplied in 32 finish.

AD8600 SERIES OPTIONS

USA & Canada Prices Effective June 3, 2019

| Options | Description | Price |
|---------|---|-----------------|
| 10 | SARGENT Signature System | \$58.00 / cyl. |
| 11 | SARGENT XC Key System (not available w/10, 22, KESO, SC, & SE options) | No addition |
| 1160 | SARGENT XC Large Format Interchangeable Plastic Disposable Construction Core | No addition |
| 1163 | SARGENT XC Large Format Interchangeable Core Cylinder – Includes masterkeying charges | \$77.00 |
| 1164 | SARGENT XC Large Format Interchangeable Construction Core Cylinder | \$77.00 |
| 1170 | Small Format interchangeable disposable construction core - to accept 7 Pin XC permanent core | No addition |
| 11727P | Small Format interchangeable keyed construction core - to accept 7 Pin XC permanent core | \$69.00 |
| 11737P | Small Format interchangeable core - to accept 7 pin XC permanent core | \$69.00 / cyl. |
| 16 | Cylinder lockdown feature in rail (not available with 12-, 57-, 59-, AL- options) | \$123.00 |
| 19 | 80 Series pushbar without Lexan touchpad | No addition |
| 21 | SARGENT Construction Key System (lost ball) | \$16.00 / cyl. |
| 22 | SARGENT Construction Key System (split key) | \$32.00 / cyl. |
| 31 | For doors greater than 1-3/4" and up to 2-1/4" (including those with auxiliary controls) | No addition |
| | For doors over 2-1/4" | Consult Factory |
| | For doors with panels (See catalog for ordering details) | No addition |
| 36 | 6 Lobe security head screws | \$60.00 |
| 37 | Spanner head screws | \$42.00 |
| 43 | Flush End Cap | No addition |
| * 53 | Latchbolt Monitor Switch – available with 55, 56, 57, 58, AL options | \$237.00 |
| 54 | Internal Micro Switch in ET Control | \$214.00 |
| * 55 | Signal Switch in Rail | \$223.00 |
| * 56 | Remote Dogging / Latch Retraction (Minimum door width for narrow stile is 26" and wide stile is 28") | \$835.00 |
| * HK56 | Latch Retraction with Hex Key Dogging | \$835.00 |
| * 57 | Delayed Action (Magnet ordered separate) | \$1,302.00 |
| * 58 | Electric Dogging | \$450.00 |
| * 59 | Electroguard (Not available with HC, 16, 53, 55, 56, 57, 58, NB options) | \$1,593.00 |
| * BC59 | Electroguard Boca Code (Needs Door Status Switch) (Not available with HC, 16, 53, 55, 56, 57, 58, NB options) | \$1,695.00 |
| 60 | SARGENT Large Format Interchangeable Plastic Disposable Construction Core | No addition |
| 63 | SARGENT Large Format Interchangeable Core Cylinder includes master and grandmaster keying charge | \$77.00 / cyl. |
| 64 | SARGENT Large Format Interchangeable Construction Core Cylinder | \$77.00 |
| 6573 | Small Format 6 Pin Uncombined Core | \$59.00 / cyl. |
| 65737P | Small Format 7 Pin Uncombined Core | \$59.00 / cyl. |
| 70 | Small Format Interchangeable Disposable plastic Construction Core | No addition |
| 72 | Small Format Interchangeable 6-Pin Construction Core (7-pin with 11 option) | \$69.00 |
| 73 | Small Format 6-pin interchangeable core | \$69.00 / cyl. |
| 73-7P | Small Format 7-pin interchangeable core | \$69.00 / cyl. |
| 76 | Tactile Warning - Milled Outside Lever (Not available with Studio, Coastal and the A Levers) | \$71.00 |
| 81 | Cylinder to accept Keso (83) and Keso F1 (F183) removable core – no core provided | No addition |
| F182 | SARGENT Keso Security, patent pending, cylinder – new key systems | \$84.00 / cyl. |
| F183 | SARGENT Keso Security, patent pending, removable core cylinder – new key systems | \$120.00 / cyl. |
| 82 | SARGENT Keso Security Cylinder (existing key systems only) | \$84.00 / cyl. |
| 83 | SARGENT Keso Security Removable Core Cylinder (existing key systems only) | \$120.00 / cyl. |
| 84 | SARGENT Keso Security Removable Construction Core Cylinder | See CK-18 |
| 85 | Tactile Warning - Abrasive Strip Inside Push Rail | \$93.00 |
| 86 | Tactile Warning - Abrasive Coating Outside Lever | \$43.00 |
| 87 | Tactile Warning - Abrasive Strip on Inside Push Rail & Coating on Outside Lever | \$136.00 |
| * AL | Alarmed (not available with 16-, 56- thru 59- options) (minimum Dr width 36") | \$550.00 |
| BR | SARGENT Bump Resistant Cylinders (N/A w/10, 22, 30, 60, 63, 64, 70, 72, 73, 737P, KESO, SC, SE) | \$23.00 / cyl. |
| CPC | Clear Powder Coat – Recommended for exit devices used in full exterior application and highly corrosive areas with 32 and 32D finishes. | \$214.00 |
| DG1 | Patented Degree DG1 Key System | No Addition |
| DG160 | Hardware prepared for DG1-6300 Lg. Format IC cores, supplied with temporary plastic construction cores | No addition |
| DG163 | Patented Degree DG1 Large Format Interchangeable Core Cylinder - Includes master keying charges | \$77.00 |
| DG164 | Hardware prepared for DG1-6300 Lg. Format IC cores, supplied with temporary keyed construction cores | \$77.00 |
| DG2 | Patented Degree DG2 Key System incorporating a locking sidebar | \$58.00/cyl. |
| DG260 | Hardware prepared for DG2-6300 Lg. Format IC cores, supplied with temporary plastic construction cores | No addition |
| DG263 | Patented Degree DG2 Large Format Interchangeable Core Cylinder - Includes master keying charges | \$135.00 |
| DG264 | Hardware prepared for DG2-6300 Lg. Format IC cores, supplied with temporary keyed construction cores | \$77.00 |
| DG3 | Patented Degree DG3 Key System incorporating a locking sidebar and UL437 listed | \$82.00/cyl. |
| DG360 | Hardware prepared for DG3-6300 Lg. Format IC cores, supplied with temporary plastic construction cores | No addition |
| DG363 | Patented Degree DG3 Large Format Interchangeable Core Cylinder - Includes master keying charges | \$159.00 |
| DG364 | Hardware prepared for DG3-6300 Lg. Format IC cores, supplied with temporary keyed construction cores | \$77.00 |
| LD | Less Cylinder | -\$89.00/cyl. |
| LD | Less Dogging | No addition |
| PL | SARGuide™ PL – Photoluminescent Coating – (Pushbar w/o Lexan Touchpad - 19 option is supplied as standard) | \$348.00 |
| NB | No Bottom Rod (Not available with 59 and BC59 option) | No addition |
| SC | Schlage C Keyway Cylinder 0-Bitted (Rim and #41 Mortise Cylinder Only) | No addition |
| SE | Schlage E Keyway Cylinder 0-Bitted (Rim and #41 Mortise Cylinder Only) | No addition |
| SG | MicroShield® an antimicrobial powder coat (not available with 10B) | \$82.00 |
| TB | Thru Bolt | \$24.00 |
| * TL | SARGuide™ – Illuminated Touchpad (not available with AL, 57, 59 options) | \$214.00 |

*** Exact door width required when ordering.**

Vertical Rod Device to 96" Height No addition

Concealed/Surface Vertical Rod Device over 96" to 120" Height \$60.00



Refer to catalog for max. door height availability on fire rated exit devices.

683 Thermal Pin Kit for use with 45/60/90 Minute Wood Doors

683 \$97.00

USA & Canada Prices Effective June 3, 2019



| AD8600 Series-Concealed Vertical Rod Device | | | |
|---|---|--|--|
|  ET Control |  ET Control |  | |
| Standard Levers: A-B-E-F-J-L-P-W Coastal Levers: G-R-S-Y All Studio Collection Levers (Except Gramercy, Wooster Square, & Grant Park) | Gramercy Series: RAG-RAL-RAM-RAS- RCM-REM-RGM Wooster Square: H001-H002-H003-H004- H005-H006 Grant Park: H007-H008-H009-H010-H011 | Auxiliary Control (106/113) with 862, 863, 864 Pull Price includes 862 Pull (shown) | |
| Finishes listed below are for the exit device. Refer to catalog for available trims, trim finishes and how to order. | | | |

| AD8600 Series | | | Finish | | | | | |
|---------------|----------|--------------------------|---------------------|---------------------------------|----------------------|---------------------------------|----------------------|---------------------|
| Option | Function | Description | 10BE/32D BSP/WSP | 03/04/09/10/10B/ 10BL/20D/32 | 10BE/32D/ BSP/WSP | 03/04/09/10/10B/ 10BL/20D/32 | 10BE/32D/ BSP/WSP | 03/04/10/ 10B/32 |
| AD | 8610 | Exit Only No Trim | \$2,699.00 | \$2,848.00 | | | | |
| AD | 8610 | Dummy Trim (Lever rigid) | \$3,396.00 | \$3,545.00 | \$3,619.00 | \$3,768.00 | \$2,969.00 | \$3,139.00 |
| AD | 8610 | Key operates control | | | | | \$3,666.00 | \$3,836.00 |
| AD | 8606 | Key operates ET | | | | | | |
| AD | 8613 | Key locks/unlocks ET | \$3,396.00 | \$3,545.00 | \$3,619.00 | \$3,768.00 | | |
| AD | 8615 | Trim always operable | | | | | | |

*When ordering Exits with Auxiliary Control Design, please order as follows: example: AD8610F x 106/113 x 862 x 32D x RHR

| AD8600 With Freewheeling Trim | | | | | | | | |
|--------------------------------|------|------------------------------|------------|------------|------------|------------|--|--|
| AD | 8640 | Dummy Trim (Lever rotates) | | | | | | |
| AD | 8643 | Key engages/disengages lever | \$3,396.00 | \$3,545.00 | \$3,619.00 | \$3,768.00 | | |
| AD | 8646 | Key operates control | | | | | | |
| AD8600 With Electro-Mechanical | | | | | | | | |
| AD | 8673 | Fail Safe 12v or 24v | | | | | | |
| AD | 8674 | Fail Secure 12v or 24v | \$3,682.00 | \$3,831.00 | \$3,859.00 | \$4,008.00 | | |

Note: Specify voltage required when ordering.

863 (18" x 1" Diameter) Pull provided in lieu of 862 (10" x 1" Diameter) Add \$66.00

864 (10" x 3/4" Diameter) Pull provided in lieu of 862 (10" x 1" Diameter) Deduct \$35.00

► Dummy Trim includes pull only, Auxiliary Control not supplied.

| Thru Bolt Application | | Pack Part # | | | Finish |
|-----------------------|--------------------|-------------|------------|---|--------------|
| | No. Bolts per Pack | 1-3/4" Dr. | 2-1/4" Dr. | 03/04/09/10/10B/10BE/10BL/20D/26D/BSP/WSP | |
| AD | 8600 | 4 | 68-2279 | 68-2280 | \$24.00 Pack |

Note: Cylinders not included when ordered less trim.

15 or 26D finishes are available on outside trim only, the exit devices will be supplied in 32D.

14 or 26 Finishes are available on outside trim only, the exit devices will be supplied in 32 finish.

MD8600 SERIES OPTIONS

USA & Canada Prices Effective June 3, 2019

| Options | Description | Price |
|---------|---|---|
| 10 | SARGENT Signature System | \$58.00 / cyl. |
| 11 | SARGENT XC Key System (not available w/10, 22, KESO, SC, & SE options) | No addition |
| 1160 | SARGENT XC Large Format Interchangeable Plastic Disposable Construction Core | No addition |
| 1163 | SARGENT XC Large Format Interchangeable Core Cylinder – Includes masterkeying charges | \$77.00 |
| 1164 | SARGENT XC Large Format Interchangeable Construction Core Cylinder | \$77.00 |
| 1170 | Small Format interchangeable disposable construction core - to accept 7 Pin XC permanent core | No addition |
| 11727P | Small Format interchangeable keyed construction core - to accept 7 Pin XC permanent core | \$69.00 |
| 11737P | Small Format interchangeable core - to accept 7 pin XC permanent core | \$69.00 / cyl. |
| 12 | UL Fire Label Exit Devices (not available with 16- & HK options) | \$177.00 |
| 16 | Cylinder lockdown feature in rail (not available with 12-, 57-, 59-, AL- options) | \$123.00 |
| 19 | 80 Series pushbar without Lexan touchpad | No addition |
| 21 | SARGENT Construction Key System (lost ball) | \$16.00 /cyl. |
| 22 | SARGENT Construction Key System (split key) | \$32.00 /cyl. |
| 31 | For doors greater than 1-3/4" and up to 2-1/4" (including those with auxiliary controls) For doors over 2-1/4" For doors with panels (See catalog for ordering details) | No addition Consult Factory No addition |
| 36 | 6 Lobe security head screws | \$60.00 |
| 37 | Spanner head screws | \$42.00 |
| 43 | Flush End Cap | No addition |
| * 53 | Latchbolt Monitor Switch – available with 55, 56, 57, 58, AL options | \$237.00 |
| 54 | Internal Micro Switch in ET Control | \$214.00 |
| * 55 | Signal Switch in Rail | \$223.00 |
| * 56 | Remote Dogging / Latch Retraction (Minimum door width for narrow stile is 26" and wide stile is 28") | \$835.00 |
| * HK56 | Latch Retraction with Hex Key Dogging | \$835.00 |
| * 57 | Delayed Action (Magnet ordered separate) | \$1,302.00 |
| * 58 | Electric Dogging | \$450.00 |
| * 59 | Electroguard (Not available with 16, 53, 55, 56, 57, 58, NB options) | \$1,593.00 |
| * BC59 | Electroguard Boca Code (Needs Door Status Switch) (Not available with 16, 53, 55, 56, 57, 58, NB options) | \$1,695.00 |
| 60 | SARGENT Large Format Interchangeable Plastic Disposable Construction Core | No addition |
| 63 | SARGENT Large Format Interchangeable Core Cylinder includes master and grandmaster keying charge | \$77.00 /cyl. |
| 64 | SARGENT Large Format Interchangeable Construction Core Cylinder | \$77.00 |
| 6573 | Small Format 6 Pin Uncombined Core | \$59.00 / cyl. |
| 65737P | Small Format 7 Pin Uncombined Core | \$59.00 / cyl. |
| 70 | Small Format Interchangeable Disposable plastic Construction Core | No addition |
| 72 | Small Format Interchangeable 6-Pin Construction Core (7-pin with 11 option) | \$69.00 |
| 73 | Small Format 6-pin interchangeable core | \$69.00 / cyl. |
| 73-7P | Small Format 7-pin interchangeable core | \$69.00 / cyl. |
| 76 | Tactile Warning - Milled Outside Lever (Not available with Studio, Coastal and the A Levers) | \$71.00 |
| 81 | Cylinder to accept Keso (83) and Keso F1 (F183) removable core – no core provided | No addition |
| F182 | SARGENT Keso Security, patent pending, cylinder – new key systems | \$84.00 / cyl. |
| F183 | SARGENT Keso Security, patent pending, removable core cylinder – new key systems | \$120.00 / cyl. |
| 82 | SARGENT Keso Security Cylinder (existing key systems only) | \$84.00 / cyl. |
| 83 | SARGENT Keso Security Removable Core Cylinder (existing key systems only) | \$120.00 / cyl. |
| 84 | SARGENT Keso Security Removable Construction Core Cylinder | See CK-18 |
| 85 | Tactile Warning - Abrasive Strip Inside Push Rail | \$93.00 |
| 86 | Tactile Warning - Abrasive Coating Outside Lever | \$43.00 |
| 87 | Tactile Warning - Abrasive Strip on Inside Push Rail & Coating on Outside Lever | \$136.00 |
| * AL | Alarmed (not available with 16-, 56- thru 59- options) (minimum Dr width 36") | \$550.00 |
| BR | SARGENT Bump Resistant Cylinders (N/A w/10, 22, 30, 60, 63, 64, 70, 72, 73, 737P, KESO, SC, SE) | \$23.00 /cyl. |
| CPC | Clear Powder Coat – Recommended for exit devices used in full exterior application and highly corrosive areas with 32 and 32D finishes. | \$214.00 |
| DG1 | Patented Degree DG1 Key System | No Addition |
| DG160 | Hardware prepared for DG1-6300 Lg. Format IC cores, supplied with temporary plastic construction cores | No addition |
| DG163 | Patented Degree DG1 Large Format Interchangeable Core Cylinder - Includes master keying charges | \$77.00 |
| DG164 | Hardware prepared for DG1-6300 Lg. Format IC cores, supplied with temporary keyed construction cores | \$77.00 |
| DG2 | Patented Degree DG2 Key System incorporating a locking sidebar | \$58.00/cyl. |
| DG260 | Hardware prepared for DG2-6300 Lg. Format IC cores, supplied with temporary plastic construction cores | No addition |
| DG263 | Patented Degree DG2 Large Format Interchangeable Core Cylinder - Includes master keying charges | \$135.00 |
| DG264 | Hardware prepared for DG2-6300 Lg. Format IC cores, supplied with temporary keyed construction cores | \$77.00 |
| DG3 | Patented Degree DG3 Key System incorporating a locking sidebar and UL437 listed | \$82.00/cyl. |
| DG360 | Hardware prepared for DG3-6300 Lg. Format IC cores, supplied with temporary plastic construction cores | No addition |
| DG363 | Patented Degree DG3 Large Format Interchangeable Core Cylinder - Includes master keying charges | \$159.00 |
| DG364 | Hardware prepared for DG3-6300 Lg. Format IC cores, supplied with temporary keyed construction cores | \$77.00 |
| LC | Less Cylinder | -\$89.00/cyl. |
| LD | Less Dogging | No addition |
| PL | SARGuide™ PL – Photoluminescent Coating – (Pushbar w/o Lexan Touchpad - 19 option is supplied as standard) | \$348.00 |
| NB | No Bottom Rod (Not available with 59 and BC59 option) | No addition |
| SC | Schlage C Keyway Cylinder 0-Bitted (Rim and #41 Mortise Cylinder Only) | No addition |
| SE | Schlage E Keyway Cylinder 0-Bitted (Rim and #41 Mortise Cylinder Only) | No addition |
| SG | MicroShield® an antimicrobial powder coat (not available with 10B) | \$82.00 |
| TB | Thru Bolt | \$24.00 |
| * TL | SARGuide™ – Illuminated Touchpad (not available with AL, 57, 59 options) | \$214.00 |

*** Exact door width required when ordering.**



| | |
|---|-------------|
| Vertical Rod Device to 96" Height | No addition |
| Concealed/Surface Vertical Rod Device over 96" to 120" Height | \$60.00 |

Refer to catalog for max. door height availability on fire rated exit devices.

| | |
|---|---------|
| 683 Thermal Pin Kit for use with 45/60/90 Minute Wood Doors | \$97.00 |
|---|---------|

USA & Canada Prices Effective June 3, 2019



| MD8600 Series-Concealed Vertical Rod Device | | | |
|---|---|---|--|
|  ET Control |  ET Control |  | with 862, 863, 864 Pull |
| Standard Levers: A-B-E-F-J-L-P-W Coastal Levers: G-R-S-Y All Studio Collection Levers (Except Gramercy, Wooster Square, & Grant Park) | Gramercy Series: RAG-RAL-RAM-RAS- RCM-REM-RGM Wooster Square: H001-H002-H003-H004- H005-H006 Grant Park: H007-H008-H009-H010-H011 | Auxiliary Control (106/113) | Price includes 862 Pull (shown) |
| Finishes listed below are for the exit device. Refer to catalog for available trims, trim finishes and how to order. | | | |

| 8600 Series | | | Finish | | | | | |
|-------------|----------|--------------------------|----------------------|---------------------------------|----------------------|---------------------------------|----------------------|---------------------|
| Option | Function | Description | 10BE/32D/ BSP/WSP | 03/04/09/10/10B/ 10BL/20D/32 | 10BE/32D/ BSP/WSP | 03/04/09/10/10B/ 10BL/20D/32 | 10BE/32D/ BSP/WSP | 03/04/10/ 10B/32 |
| MD | 8610 | Exit Only No Trim | \$2,699.00 | \$2,848.00 | | | | |
| MD | 8610 | Dummy Trim (Lever rigid) | \$3,396.00 | \$3,545.00 | \$3,619.00 | \$3,768.00 | \$2,969.00 | \$3,139.00 |
| *MD | 8610 | Key operates control | | | | | \$3,666.00 | \$3,836.00 |
| MD | 8606 | Key operates ET | | | | | | |
| MD | 8613 | Key locks/unlocks ET | \$3,396.00 | \$3,545.00 | \$3,619.00 | \$3,768.00 | | |
| MD | 8615 | Trim always operable | | | | | | |

*When ordering Exits with Auxiliary Control Design, please order as follows: example: MD8610F x 106/113 x 862 x 32D x RHR

| MD8600 Series With Freewheeling Trim | | | | | | | | |
|---------------------------------------|------|------------------------------|------------|------------|------------|------------|--|--|
| MD | 8640 | Dummy Trim (Lever rotates) | | | | | | |
| MD | 8643 | Key engages/disengages lever | \$3,396.00 | \$3,545.00 | \$3,619.00 | \$3,768.00 | | |
| MD | 8646 | Key operates control | | | | | | |
| MD8600 Series With Electro-Mechanical | | | | | | | | |
| MD | 8673 | Fail Safe 12v or 24v | \$3,682.00 | \$3,831.00 | \$3,859.00 | \$4,008.00 | | |
| MD | 8674 | Fail Secure 12v or 24v | | | | | | |

Note: Specify voltage required when ordering.

| | |
|--|----------------|
| 863 (18" x 1" Diameter) Pull provided in lieu of 862 (10" x 1" Diameter) | Add \$66.00 |
| 864 (10" x 3/4" Diameter) Pull provided in lieu of 862 (10" x 1" Diameter) | Deduct \$35.00 |

► Dummy Trim includes pull only, Auxiliary Control not supplied.

| Thru Bolt Application | | Pack Part # | | Finish | |
|-----------------------|--------------------|-------------|------------|---|--------------|
| | No. Bolts per Pack | 1-3/4" Dr. | 2-1/4" Dr. | 03/04/09/10/10B/10BE/10BL/20D/26D/BSP/WSP | |
| MD | 8600 | 4 | 68-2279 | 68-2280 | \$24.00 Pack |

Note: Cylinders not included when ordered less trim.

15 or 26D finishes are available on outside trim only, the exit devices will be supplied in 32D.

14 or 26 Finishes are available on outside trim only, the exit devices will be supplied in 32 finish.



WD8600 SERIES OPTIONS

USA & Canada Prices Effective June 3, 2019

| Options | Description | Price |
|--|---|-----------------|
| 10 | SARGENT Signature System | \$58.00 / cyl. |
| 11 | SARGENT XC Key System (not available w/10, 22, KESO, SC, & SE options) | No addition |
| 1160 | SARGENT XC Large Format Interchangeable Plastic Disposable Construction Core | No addition |
| 1163 | SARGENT XC Large Format Interchangeable Core Cylinder – Includes masterkeying charges | \$77.00 |
| 1164 | SARGENT XC Large Format Interchangeable Construction Core Cylinder | \$77.00 |
| 1170 | Small Format interchangeable disposable construction core - to accept 7 Pin XC permanent core | No addition |
| 11727P | Small Format interchangeable keyed construction core - to accept 7 Pin XC permanent core | \$69.00 |
| 11737P | Small Format interchangeable core - to accept 7 pin XC permanent core | \$69.00 / cyl. |
| 12 | UL Fire Label Exit Devices (not available with 16- & HK options) | \$177.00 |
| 16 | Cylinder lockdown feature in rail (not available with 12-, 57-, 59-, AL- options) | \$123.00 |
| 19 | 80 Series pushbar without Lexan touchpad | No addition |
| 21 | SARGENT Construction Key System (lost ball) | \$16.00 /cyl. |
| 22 | SARGENT Construction Key System (split key) | \$32.00 /cyl. |
| 31 | For doors greater than 1-3/4" and up to 2-1/4" (including those with auxiliary controls) | No addition |
| | For doors over 2-1/4" | Consult Factory |
| | For doors with panels (See catalog for ordering details) | No addition |
| 36 | 6 Lobe security head screws | \$60.00 |
| 37 | Spanner head screws | \$42.00 |
| 43 | Flush End Cap | No addition |
| * 53 | Latchbolt Monitor Switch – Available with 55, 56, 57, 58, AL options | \$237.00 |
| 54 | Internal Micro Switch in ET Control | \$214.00 |
| * 55 | Signal Switch in Rail | \$223.00 |
| * 56 | Remote Dogging / Latch Retraction (Minimum door width for narrow stile is 26" and wide stile is 28") | \$835.00 |
| * HK56 | Latch Retraction with Hex Key Dogging | \$835.00 |
| * 57 | Delayed Action (Magnet ordered separate) | \$1,302.00 |
| * 58 | Electric Dogging | \$450.00 |
| * 59 | Electroguard (Not available with 16, 53, 55, 56, 57, 58, NB options) | \$1,593.00 |
| * BC59 | Electroguard Boca Code (Needs Door Status Switch) (Not available with 16, 53, 55, 56, 57, 58, NB options) | \$1,695.00 |
| 60 | SARGENT Large Format Interchangeable Plastic Disposable Construction Core | No addition |
| 63 | SARGENT Large Format Interchangeable Core Cylinder includes master and grandmaster keying charge | \$77.00 /cyl. |
| 64 | SARGENT Large Format Interchangeable Construction Core Cylinder | \$77.00 |
| 6573 | Small Format 6 Pin Uncombined Core | \$59.00 / cyl. |
| 65737P | Small Format 7 Pin Uncombined Core | \$59.00 / cyl. |
| 70 | Small Format Interchangeable Disposable construction plastic core | No addition |
| 72 | Small Format Interchangeable 6-Pin Construction Core (7-pin with 11 option) | \$69.00 |
| 73 | Small Format 6-pin interchangeable core | \$69.00 / cyl. |
| 737P | Small Format 7-pin interchangeable core | \$69.00 / cyl. |
| 76 | Tactile Warning - Milled Outside Lever (Not available with Studio, Coastal and the A Levers) | \$71.00 |
| 81 | Cylinder to accept Keso (83) and Keso F1 (183) removable core – no core provided | No addition |
| F182 | SARGENT Keso Security, patent pending, cylinder – new key systems | \$84.00 / cyl. |
| F183 | SARGENT Keso Security, patent pending, removable core cylinder – new key systems | \$120.00 / cyl. |
| 82 | SARGENT Keso Security Cylinder (existing key systems only) | \$84.00 / cyl. |
| 83 | SARGENT Keso Security Removable Core Cylinder (existing key systems only) | \$120.00 / cyl. |
| 84 | SARGENT Keso Security Removable Construction Core Cylinder | See CK-18 |
| 85 | Tactile Warning - Abrasive Strip Inside Push Rail | \$93.00 |
| 86 | Tactile Warning - Abrasive Coating Outside Lever | \$43.00 |
| 87 | Tactile Warning - Abrasive Strip on Inside Push Rail & Coating on Outside Lever | \$136.00 |
| * AL | Alarmed (not available with 16-, 56- thru 59- options) (minimum Dr width 36") | \$550.00 |
| BR | SARGENT Bump Resistant Cylinders (N/A w/10, 22, 30, 60, 63, 64, 70, 72, 73, 737P, KESO, SC, SE) | \$23.00 /cyl. |
| CPC | Clear Powder Coat – Recommended for exit devices used in full exterior application and highly corrosive areas with 32 and 32D finishes. | \$214.00 |
| DG1 | Patented Degree DG1 Key System | No Addition |
| DG160 | Hardware prepared for DG1-6300 Lg. Format IC cores, supplied with temporary plastic construction cores | No addition |
| DG163 | Patented Degree DG1 Large Format Interchangeable Core Cylinder - Includes master keying charges | \$77.00 |
| DG164 | Hardware prepared for DG1-6300 Lg. Format IC cores, supplied with temporary keyed construction cores | \$77.00 |
| DG2 | Patented Degree DG2 Key System incorporating a locking sidebar | \$58.00/cyl. |
| DG260 | Hardware prepared for DG2-6300 Lg. Format IC cores, supplied with temporary plastic construction cores | No addition |
| DG263 | Patented Degree DG2 Large Format Interchangeable Core Cylinder - Includes master keying charges | \$135.00 |
| DG264 | Hardware prepared for DG2-6300 Lg. Format IC cores, supplied with temporary keyed construction cores | \$77.00 |
| DG3 | Patented Degree DG3 Key System incorporating a locking sidebar and UL437 listed | \$82.00/cyl. |
| DG360 | Hardware prepared for DG3-6300 Lg. Format IC cores, supplied with temporary plastic construction cores | No addition |
| DG363 | Patented Degree DG3 Large Format Interchangeable Core Cylinder - Includes master keying charges | \$159.00 |
| DG364 | Hardware prepared for DG3-6300 Lg. Format IC cores, supplied with temporary keyed construction cores | \$77.00 |
| LC | Less Cylinder | -\$89.00/cyl. |
| LD | Less Dogging | No addition |
| PL | SARGuide™ PL – Photoluminescent Coating – (Pushbar w/o Lexan Touchpad - 19 option is supplied as standard) | \$348.00 |
| NB | No Bottom (Not available with 59 and BC59 option) | No addition |
| SC | Schlage C Keyway Cylinder 0-Bitted (Rim and #41 Mortise Cylinder Only) | No addition |
| SE | Schlage E Keyway Cylinder 0-Bitted (Rim and #41 Mortise Cylinder Only) | No addition |
| SG | MicroShield® an antimicrobial powder coat (not available with 10B) | \$82.00 |
| TB | Thru Bolt | \$24.00 |
| * TL | SARGuide™ – Illuminated Touchpad (not available with AL, 57, 59 options) | \$214.00 |
| * Exact door width required when ordering. | | |
| | Vertical Rod Device to 96" Height | No addition |
| | Concealed/Surface Vertical Rod Device over 96" to 120" Height | \$60.00 |
| Refer to catalog for max. door height availability on fire rated exit devices. | | |
| 683 Thermal Pin Kit for use with 45/60/90 Minute Wood Doors | | |
| 683 | | \$97.00 |

USA & Canada Prices Effective June 3, 2019



| WD8600 Series-Concealed Vertical Rod Device | | | |
|---|---|---|--|
|  ET Control |  ET Control |  | |
| Standard Levers: A-B-E-F-J-L-P-W Coastal Levers: G-R-S-Y All Studio Collection Levers (Except Gramercy, Wooster Square, & Grant Park) | Gramercy Series: RAG-RAL-RAM-RAS-RCM-REM-RGM Wooster Square: H001-H002-H003-H004-H005-H006 Grant Park: H007-H008-H009-H010-H011 | Auxiliary Control (106/113) | with 862, 863, 864 Pull Price includes 862 Pull (shown) |
| Finishes listed below are for the exit device. Refer to catalog for available trims, trim finishes and how to order. | | | |

| WD8600 Series | | | Finish | | | | | |
|---------------|----------|--------------------------|----------------------|---------------------------------|----------------------|---------------------------------|----------------------|---------------------|
| Option | Function | Description | 10BE/32D/ BSP/WSP | 03/04/09/10/10B/ 10BL/20D/32 | 10BE/32D/ BSP/WSP | 03/04/09/10/10B/ 10BL/20D/32 | 10BE/32D/ BSP/WSP | 03/04/10/ 10B/32 |
| WD | 8610 | Exit Only No Trim | \$2,908.00 | \$3,057.00 | | | | |
| WD | 8610 | Dummy Trim (Lever rigid) | \$3,605.00 | \$3,754.00 | \$3,828.00 | \$3,977.00 | \$3,178.00 | \$3,348.00 |
| *WD | 8610 | Key operates control | | | | | \$3,875.00 | \$4,045.00 |
| WD | 8606 | Key operates ET | | | | | | |
| WD | 8613 | Key locks/unlocks ET | \$3,605.00 | \$3,754.00 | \$3,828.00 | \$3,977.00 | | |
| WD | 8615 | Trim always operable | | | | | | |

*When ordering Exits with Auxiliary Control Design, please order as follows: example: WD8610F x 106/113 x 862 x 32D x RHR

| WD8600 Series With Freewheeling Trim | | | | | | | | |
|---------------------------------------|------|------------------------------|------------|------------|------------|------------|--|--|
| WD | 8640 | Dummy Trim (Lever rotates) | | | | | | |
| WD | 8643 | Key engages/disengages lever | \$3,605.00 | \$3,754.00 | \$3,828.00 | \$3,977.00 | | |
| WD | 8646 | Key operates control | | | | | | |
| WD8600 Series With Electro-Mechanical | | | | | | | | |
| WD | 8673 | Fail Safe 12v or 24v | \$3,891.00 | \$4,040.00 | \$4,068.00 | \$4,217.00 | | |
| WD | 8674 | Fail Secure 12v or 24v | | | | | | |

Note: Specify voltage required when ordering.

863 (18" x 1" Diameter) Pull provided in lieu of 862 (10" x 1" Diameter) Add \$66.00

864 (10" x 3/4" Diameter) Pull provided in lieu of 862 (10" x 1" Diameter) Deduct \$35.00

► Dummy Trim includes pull only, Auxiliary Control not supplied.

| Thru Bolt Application | | Pack Part # | | | Finish | |
|-----------------------|--------------------|-------------|------------|---|--------------|--|
| | No. Bolts per Pack | 1-3/4" Dr. | 2-1/4" Dr. | 03/04/09/10/10B/10BE/10BL/20D/26D/BSP/WSP | | |
| WD | 8600 | 4 | 68-2279 | 68-2280 | \$24.00 Pack | |

Note: Cylinders not included when ordered less trim.

15 or 26D finishes are available on outside trim only, the exit devices will be supplied in 32D.

14 or 26 Finishes are available on outside trim only, the exit devices will be supplied in 32 finish.

ED-24 EXIT DEVICES

SARGENT®

LS8600 • LP8600 • LR8600 SERIES OPTIONS

ASSA ABLOY

USA & Canada Prices Effective June 3, 2019

| Options | Description | Price |
|---------|---|-----------------|
| 10 | SARGENT Signature System | \$58.00 / cyl. |
| 11 | SARGENT XC Key System (not available w/10, 22, KESO, SC, & SE options) | No addition |
| 1160 | SARGENT XC Large Format Interchangeable Plastic Disposable Construction Core | No addition |
| 1163 | SARGENT XC Large Format Interchangeable Core Cylinder – Includes masterkeying charges | \$77.00 |
| 1164 | SARGENT XC Large Format Interchangeable Construction Core Cylinder | \$77.00 |
| 1170 | Small Format interchangeable disposable construction core - to accept 7 Pin XC permanent core | No addition |
| 11727P | Small Format interchangeable keyed construction core - to accept 7 Pin XC permanent core | \$69.00 |
| 11737P | Small Format interchangeable core - to accept 7 pin XC permanent core | \$69.00 / cyl. |
| 12 | UL Fire Label Exit Devices (not available with 16- & HK options) | \$177.00 |
| 16 | Cylinder lockdown feature in rail (not available with 12- options) | \$123.00 |
| 19 | Series pushbar without Lexan touchpad | No addition |
| 21 | SARGENT Construction Key System (lost ball) | \$16.00 / cyl. |
| 22 | SARGENT Construction Key System (split key) | \$32.00 / cyl. |
| 36 | 6 Lobe security head screws | \$60.00 |
| 37 | Spanner head screws | \$42.00 |
| 43 | Flush End Cap | No addition |
| * 55 | Signal Switch in Rail | \$223.00 |
| * 56 | Remote Dogging / Latch Retraction (Minimum door width for narrow stile is 26" and wide stile is 28") | \$835.00 |
| * HK56 | Latch Retraction with Hex Key Dogging | \$835.00 |
| * 58 | Electric Dogging | \$450.00 |
| 60 | SARGENT Large Format Interchangeable Plastic Disposable Construction Core | No addition |
| 63 | SARGENT Large Format Interchangeable Core Cylinder includes master and grandmaster keying charge | \$77.00 / cyl. |
| 64 | SARGENT Large Format Interchangeable Construction Core Cylinder | \$77.00 |
| 6573 | Small Format 6 Pin Uncombined Core | \$59.00 / cyl. |
| 65737P | Small Format 7 Pin Uncombined Core | \$59.00 / cyl. |
| 70 | Small Format Interchangeable disposable Plastic construction core | No addition |
| 72 | Small Format Interchangeable 6-Pin Construction Core (7-pin with 11 option) | \$69.00 |
| 73 | Small Format 6-Pin interchangeable core | \$69.00 / cyl. |
| 737P | Small Format 7-pin interchangeable core | \$69.00 / cyl. |
| 76 | Tactile Warning - Milled Outside Lever (Not available with Studio, Coastal and the A Levers) | \$71.00 |
| 81 | Cylinder to accept Keso (83) and Keso F1 (F183) removable core – no core provided | No addition |
| F182 | SARGENT Keso Security, patent pending, cylinder – new key systems | \$84.00 / cyl. |
| F183 | SARGENT Keso Security, patent pending, removable core cylinder – new key systems | \$120.00 / cyl. |
| 82 | SARGENT Keso Security Cylinder (existing key systems only) | \$84.00 / cyl. |
| 83 | SARGENT Keso Security Removable Core Cylinder (existing key systems only) | \$120.00 / cyl. |
| 84 | SARGENT Keso Security Removable Construction Core Cylinder | See CK-18 |
| 85 | Tactile Warning - Abrasive Strip Inside Push Rail | \$93.00 |
| 86 | Tactile Warning - Abrasive Coating Outside Lever | \$43.00 |
| 87 | Tactile Warning - Abrasive Strip on Inside Push Rail & Coating on Outside Lever | \$136.00 |
| BR | SARGENT Bump Resistant Cylinders (N/A w/10, 22, 30, 60, 63, 64, 70, 72, 73, 737P, KESO, SC, SE) | \$23.00 /cyl. |
| CPC | Clear Powder Coat – Recommended for exit devices used in full exterior application and highly corrosive areas with 32 and 32D finishes. | \$214.00 |
| DG1 | Patented Degree DG1 Key System | No Addition |
| DG160 | Hardware prepared for DG1-6300 Lg. Format IC cores, supplied with temporary plastic construction cores | No addition |
| DG163 | Patented Degree DG1 Large Format Interchangeable Core Cylinder - Includes master keying charges | \$77.00 |
| DG164 | Hardware prepared for DG1-6300 Lg. Format IC cores, supplied with temporary keyed construction cores | \$77.00 |
| DG2 | Patented Degree DG2 Key System incorporating a locking sidebar | \$58.00/cyl. |
| DG260 | Hardware prepared for DG2-6300 Lg. Format IC cores, supplied with temporary plastic construction cores | No addition |
| DG263 | Patented Degree DG2 Large Format Interchangeable Core Cylinder - Includes master keying charges | \$135.00 |
| DG264 | Hardware prepared for DG2-6300 Lg. Format IC cores, supplied with temporary keyed construction cores | \$77.00 |
| DG3 | Patented Degree DG3 Key System incorporating a locking sidebar and UL437 listed | \$82.00/cyl. |
| DG360 | Hardware prepared for DG3-6300 Lg. Format IC cores, supplied with temporary plastic construction cores | No addition |
| DG363 | Patented Degree DG3 Large Format Interchangeable Core Cylinder - Includes master keying charges | \$159.00 |
| DG364 | Hardware prepared for DG3-6300 Lg. Format IC cores, supplied with temporary keyed construction cores | \$77.00 |
| LC | Less Cylinder | -\$89.00/cyl. |
| LD | Less Dogging | No addition |
| PL | SARGuide™ PL – Photoluminescent Coating – (Pushbar w/o Lexan Touchpad - 19 option is supplied as standard) | \$348.00 |
| SC | Schlage C Keyway Cylinder 0-Bitted (Rim and #41 Mortise Cylinder Only) | No addition |
| SE | Schlage E Keyway Cylinder 0-Bitted (Rim and #41 Mortise Cylinder Only) | No addition |
| SG | MicroShield® an antimicrobial powder coat (not available with 10B) | \$82.00 |
| * TL | SARGuide™ – Illuminated Touchpad (not available with AL, 57, 59 options) | \$214.00 |

Only available for 36", 42", 44", 46" and 48" doors. No other sizes available.

***Exact door width required when ordering.**

| | |
|--|-------------|
| Vertical Rod Device to 96" Height | No addition |
| Concealed/Surface Vertical Rod Device over 96" to 120" Height | \$60.00 |
| Refer to catalog for max. door height availability on fire rated exit devices. | |

ASSA ABLOY

LS8600 SERIES • LP8600 SERIES • LR8600 SERIES

Low Profile Exit Device

Finishes listed below are for the exit device. Refer to catalog for available trims, trim finishes and how to order.



Standard Levers:
A-B-E-F-J-L-P-W
Coastal Levers:
G-R-S-Y
All Studio Collection Levers
(Except Gramercy, Wooster Square, & Grant Park)

USA & Canada Prices Effective June 3, 2019



Gramercy Series:
RAG-RAL-RAM-RAS-
RCM-REM-RGM
Wooster Square:
H001-H002-H003-H004-H005-H006
Grant Park:
H007-H008-H009-H010-H011

| LS8600 Series Single Door Projecting Bolt Function | | | Finish | | | |
|--|----------|-------------------------------|----------------------|---------------------------------|----------------------|---------------------------------|
| Options | Function | Description | 10BE/32D/ BSP/WSP | 03/04/09/10/10B/ 10BL/20D/32 | 10BE/32D/ BSP/WSP | 03/04/09/10/10B/ 10BL/20D/32 |
| LS | 8610 | Exit Only - No Trim | \$2,780.00 | \$2,929.00 | | |
| LS | 8610 | Dummy Trim (Lever rigid) | | | | |
| LS | 8606 | Key operates control | | | | |
| LS | 8613 | Key locks/unlocks control | \$3,477.00 | \$3,626.00 | \$3,700.00 | \$3,849.00 |
| LS | 8615 | Trim controls always operable | | | | |
| *LS | 8673 | Fail Safe 12v or 24v | \$3,763.00 | \$3,912.00 | \$3,940.00 | \$4,089.00 |
| *LS | 8674 | Fail Secure 12v or 24v | | | | |
| LS8600 Series With Freewheeling Trim | | | | | | |
| LS | 8640 | Dummy Trim (Lever rotates) | | | | |
| LS | 8643 | Key engages/disengages lever | \$3,477.00 | \$3,626.00 | \$3,700.00 | \$3,849.00 |
| LS | 8646 | Key operates control | | | | |
| LP8600 Series Pair of Doors Projecting Bolt (For Active Door) | | | | | | |
| LP | 8610 | Exit Only - No Trim | \$2,780.00 | \$2,929.00 | | |
| LP | 8610 | Dummy Trim (Lever rigid) | | | | |
| LP | 8606 | Key operates control | | | | |
| LP | 8613 | Key locks/unlocks control | \$3,477.00 | \$3,626.00 | \$3,700.00 | \$3,849.00 |
| LP | 8615 | Trim controls always operable | | | | |
| *LP | 8673 | Fail Safe 12v or 24v | \$3,763.00 | \$3,912.00 | \$3,940.00 | \$4,089.00 |
| *LP | 8674 | Fail Secure 12v or 24v | | | | |
| LP8600 Series With Freewheeling Trim | | | | | | |
| LP | 8640 | Dummy Trim (Lever rotates) | | | | |
| LP | 8643 | Key engages/disengages lever | \$3,477.00 | \$3,626.00 | \$3,700.00 | \$3,849.00 |
| LP | 8646 | Key operates control | | | | |
| LR8600 Series Pair of Doors Recessed Bolt (For Inactive Door) | | | | | | |
| LR | 8610 | Exit Only - No Trim | \$2,780.00 | \$2,929.00 | | |
| LR | 8610 | Dummy Trim (Lever rigid) | | | | |
| LR | 8606 | Key operates control | | | | |
| LR | 8613 | Key locks/unlocks control | \$3,477.00 | \$3,626.00 | \$3,700.00 | \$3,849.00 |
| LR | 8615 | Trim controls always operable | | | | |
| *LR | 8673 | Fail Safe 12v or 24v | \$3,763.00 | \$3,912.00 | \$3,940.00 | \$4,089.00 |
| *LR | 8674 | Fail Secure 12v or 24v | | | | |
| LR8600 Series With Freewheeling Trim | | | | | | |
| LR | 8640 | Dummy Trim (Lever rotates) | | | | |
| LR | 8643 | Key engages/disengages lever | \$3,477.00 | \$3,626.00 | \$3,700.00 | \$3,849.00 |
| LR | 8646 | Key operates control | | | | |

NOTE:

*LS/LP/LR8673 and 8674 – Specify voltage required when ordering.

Cylinders not included when ordered less trim.

15 or 26D finishes are available on outside trim only, the exit devices will be supplied in 32D.

14 or 26 Finishes are available on outside trim only, the exit devices will be supplied in 32 finish.

8700 SERIES OPTIONS





USA & Canada Prices Effective June 3, 2019

| Options | Description | Price |
|---------|---|-----------------|
| 10 | SARGENT Signature System | \$58.00 / cyl. |
| 11 | SARGENT XC Key System (not available w/10, 22, KESO, SC, & SE options) | No addition |
| 1160 | SARGENT XC Large Format Interchangeable Plastic Disposable Construction Core | No addition |
| 1163 | SARGENT XC Large Format Interchangeable Core Cylinder – Includes masterkeying charges | \$77.00 |
| 1164 | SARGENT XC Large Format Interchangeable Construction Core Cylinder | \$77.00 |
| 1170 | Small Format interchangeable disposable construction core - to accept 7 Pin XC permanent core | No addition |
| 11727P | Small Format interchangeable keyed construction core - to accept 7 Pin XC permanent core | \$69.00 |
| 11737P | Small Format interchangeable core - to accept 7 pin XC permanent core | \$69.00 / cyl. |
| 12 | UL Fire Label Exit Devices (not available with 16- & HK options) | \$177.00 |
| 14 | Sliding bolt bottom case for 8700 Series | No addition |
| 16 | Cylinder lockdown feature in rail (not available with 12-, 57-, 59-, AL- options) | \$123.00 |
| 19 | 80 Series pushbar without Lexan touchpad | No addition |
| 21 | SARGENT Construction Key System (lost ball) | \$16.00 / cyl. |
| 22 | SARGENT Construction Key System (split key) | \$32.00 / cyl. |
| 31 | For doors greater than 1-3/4" and up to 2-1/4" (including those with auxiliary controls) | No addition |
| | For doors over 2-1/4" | Consult Factory |
| | For doors with panels (See catalog for ordering details) | No addition |
| 36 | 6 Lobe security head screws | \$88.00 |
| 37 | Spanner head screws | \$58.00 |
| 43 | Flush End Cap | No addition |
| * 53 | Latchbolt Monitor Switch – available with 55, 56, 57, 58, AL options – not available with NB | \$237.00 |
| 54 | Internal Micro Switch in ET Control | \$214.00 |
| * 55 | Signal Switch in Rail | \$223.00 |
| * 56 | Remote Dogging / Latch Retraction (Minimum door width for narrow stile is 26" and wide stile is 28") | \$835.00 |
| * HK56 | Latch Retraction with Hex Key Dogging | \$835.00 |
| * 57 | Delayed Action (Magnet ordered separate) | \$1,302.00 |
| * 58 | Electric Dogging | \$450.00 |
| * 59 | Electroguard (Not available with 16-, 53-, 55-, 56-, 57-, 58- Options) | \$1,593.00 |
| * BC59 | Electroguard Boca Code (Needs Door Status Switch) (Not available with 16-, 53-, 55-, 56-, 57-, 58- Options) | \$1,695.00 |
| 60 | SARGENT Large Format Interchangeable Plastic Disposable Construction Core | No addition |
| 63 | SARGENT Large Format Interchangeable Core Cylinder includes master and grandmaster keying charge | \$77.00 /cyl. |
| 64 | SARGENT Large Format Interchangeable Construction Core Cylinder | \$77.00 |
| 6573 | Small Format 6 Pin Uncombined Core | \$59.00 / cyl. |
| 65737P | Small Format 7 Pin Uncombined Core | \$59.00 / cyl. |
| 70 | Small Format Interchangeable Disposable plastic construction core | No addition |
| 72 | Small Format Interchangeable 6-Pin Construction Core (7-pin with 11 option) | \$69.00 |
| 73 | Small Format 6-pin interchangeable core | \$69.00 / cyl. |
| 737P | Small Format 7-pin interchangeable core | \$69.00 / cyl. |
| 76 | Tactile Warning - Milled Outside Lever (Not available with Studio, Coastal and the A Levers) | \$71.00 |
| 81 | Cylinder to accept Keso (83) and Keso F1 (F183) removable core – no core provided | No addition |
| F182 | SARGENT Keso Security, patent pending, cylinder – new key systems | \$84.00 / cyl. |
| F183 | SARGENT Keso Security, patent pending, removable core cylinder – new key systems | \$120.00 / cyl. |
| 82 | SARGENT Keso Security Cylinder (existing key systems only) | \$84.00 / cyl. |
| 83 | SARGENT Keso Security Removable Core Cylinder (existing key systems only) | \$120.00 / cyl. |
| 84 | SARGENT Keso Security Removable Construction Core Cylinder | See CK-18 |
| 85 | Tactile Warning - Abrasive Strip Inside Push Rail | \$93.00 |
| 86 | Tactile Warning - Abrasive Coating Outside Lever | \$43.00 |
| 87 | Tactile Warning - Abrasive Strip on Inside Push Rail & Coating on Outside Lever | \$136.00 |
| * AL | Alarmed (not available with HC, 16, 56 thru 59 options) | \$550.00 |
| BR | SARGENT Bump Resistant Cylinders (N/A w/10, 22, 30, 60, 63, 64, 70, 72, 73, 737P, KESO, SC, SE) | \$23.00 /cyl. |
| CPC | Clear Powder Coat – Rec. for Exit Dvcs. used in full ext. appl. & highly corrosive areas w/32 & 32D finishes. | \$214.00 |
| DG1 | Patented Degree DG1 Key System | No Addition |
| DG160 | Hardware prepared for DG1-6300 Lg. Format IC cores, supplied with temporary plastic construction cores | No addition |
| DG163 | Patented Degree DG1 Large Format Interchangeable Core Cylinder - Includes master keying charges | \$77.00 |
| DG164 | Hardware prepared for DG1-6300 Lg. Format IC cores, supplied with temporary keyed construction cores | \$77.00 |
| DG2 | Patented Degree DG2 Key System incorporating a locking sidebar | \$58.00/cyl. |
| DG260 | Hardware prepared for DG2-6300 Lg. Format IC cores, supplied with temporary plastic construction cores | No addition |
| DG263 | Patented Degree DG2 Large Format Interchangeable Core Cylinder - Includes master keying charges | \$135.00 |
| DG264 | Hardware prepared for DG2-6300 Lg. Format IC cores, supplied with temporary keyed construction cores | \$77.00 |
| DG3 | Patented Degree DG3 Key System incorporating a locking sidebar and UL437 listed | \$82.00/cyl. |
| DG360 | Hardware prepared for DG3-6300 Lg. Format IC cores, supplied with temporary plastic construction cores | No addition |
| DG363 | Patented Degree DG3 Large Format Interchangeable Core Cylinder - Includes master keying charges | \$159.00 |
| DG364 | Hardware prepared for DG3-6300 Lg. Format IC cores, supplied with temporary keyed construction cores | \$77.00 |
| HC | Hurricane Code | \$120.00 |
| 12HC | UL Fire Label Hurricane Code | \$297.00 |
| HC4 | Hurricane-Resistant | \$229.00 |
| 12HC4 | UL Fire Label Hurricane Code | \$406.00 |
| LC | Less Cylinder | -\$89.00/cyl. |
| LD | Less Dogging | No addition |
| PL | SARGuide™ PL – Photoluminescent Coating – (Pushbar w/o Lexan Touchpad - 19 option is supplied as standard) | \$348.00 |
| SC | Schlage C Keyway Cylinder 0-Bitted (Rim and #41 Mortise Cylinder Only) | No addition |
| SE | Schlage E Keyway Cylinder 0-Bitted (Rim and #41 Mortise Cylinder Only) | No addition |
| SG | MicroShield® an antimicrobial powder coat (not available with 10B) | \$82.00 |
| TB | Thru Bolt | \$74.00 |
| * TL | SARGuide™ – Illuminated Touchpad (not available with AL, 57, 59 options) | \$214.00 |

*** Exact door width required when ordering.**

Vertical Rod Device to 96" Height No addition • Concealed/Surface Vertical Rod Device over 96" to 120" Height \$60.00
Refer to catalog for max. door height availability on fire rated exit devices.



| 8700 Series-Surface Vertical Rod Device | | | |
|---|---|--|--|
|  ET Control |  ET Control |  PTB STS-MAL-FLL-FLW |   306/313 Auxiliary Control with 862, 863 864 Pull Price includes 862 Pull (shown) |
| Standard Levers: A-B-E-F-J-L-P-W Coastal Levers: G-R-S-Y All Studio Collection Levers (Except Gramercy, Wooster Square, & Grant Park) | Gramercy Series: RAG-RAL-RAM-RAS-RCM-REM-RGM Wooster Square: H001-H002-H003-H004-H005-H006 Grant Park: H007-H008-H009-H010-H011 | | |
| Finishes listed below are for the exit device. Refer to catalog for available trims, trim finishes and how to order. | | | |

| 8700 Series | Function Description | Finish | | | | | | |
|-------------|-----------------------------|-----------------------------------|------------------------|-----------------------------------|------------------------|-----------------------------------|------------------------|---------------------------|
| | | 03/04/09/ 10BE/32D/ BSP/WSP | 10/10B/10BL/ 20D/32 | 03/04/09/ 10BE/32D/ BSP/WSP | 10/10B/10BL/ 20D/32 | 03/04/09/ 10BE/32D/ BSP/WSP | 10/10B/10BL/ 20D/32 | 03/04/10 10B/32 |
| 8710 | Exit Only - No Trim | \$2,341.00 | \$2,501.00 | | | | | |
| 8710 | Dummy Trim (Lever rigid) | \$3,038.00 | \$3,198.00 | \$3,261.00 | \$3,421.00 | \$2,764.00 | \$2,924.00 | \$2,611.00 ▶ \$2,792.00 ▶ |
| *8710 | Key operates control | | | | | | | \$3,308.00 \$3,489.00 |
| 8706 | Key operates ET | | | | | | | |
| 8713 | Key locks/unlocks ET | \$3,038.00 | \$3,198.00 | \$3,261.00 | \$3,421.00 | | | |
| 8715 | Trim always operable | | | | | | | |
| 8728 | Thumb pc.always operable | | | | | | | |
| 8762 | Key operates Thumb piece | | | | | \$2,848.00 | \$3,008.00 | |
| 8763 | Key Locks/unlocks Thumb pc. | | | | | | | |

*When ordering Exits with Auxiliary Control Design, please order as follows: example: 8710F x 306/313 x 862 x 32D x RHR

| 8700 Series With Freewheeling Trim | | | | | | | |
|-------------------------------------|------------------------------|------------|------------|------------|------------|--|--|
| 8740 | Dummy Trim (Lever rotates) | | | | | | |
| 8743 | Key engages/disengages lever | \$3,038.00 | \$3,198.00 | \$3,261.00 | \$3,421.00 | | |
| 8746 | Key operates control | | | | | | |
| 8700 Series With Electro-Mechanical | | | | | | | |
| 8773 | Fail Safe 12v or 24v | \$3,324.00 | \$3,484.00 | \$3,501.00 | \$3,661.00 | | |
| 8774 | Fail Secure 12v or 24v | | | | | | |

Note: Specify voltage required when ordering.

863 (18" x 1" Diameter) Pull provided in lieu of 862 (10" x 1" Diameter) Add \$66.00

864 (10" x 3/4" Diameter) Pull provided in lieu of 862 (10" x 1" Diameter) Deduct \$35.00

▶ Dummy Trim includes pull only, Auxiliary Control not supplied.

| Thru Bolt Application | No. Bolts per Pack | Pack Part # | | Finish |
|-----------------------|--------------------|-------------|------------|--------------|
| | | 1-3/4" Dr. | 2 1/4" Dr. | |
| 8700 Rail & Chassis | 4 | 68-2279 | 68-2280 | \$24.00 Pack |
| 8700 Cases & Guides | 10 | 68-2282 | 68-2283 | \$59.00 Pack |
| 12-8700 | 16 | 68-2288 | 68-2289 | \$90.00 Pack |

NOTES:

Cylinders not included when ordered less trim.

15 or 26D finishes are available on outside trim only, the exit devices will be supplied in 32D.

14 or 26 Finishes are available on outside trim only, the exit devices will be supplied in 32 finish.



NB8700 SERIES OPTIONS

USA & Canada Prices Effective June 3, 2019

| Options | Description | Price |
|--|---|-----------------|
| 10 | SARGENT Signature System | \$58.00 / cyl. |
| 11 | SARGENT XC Key System (not available w/10, 22, KESO, SC, & SE options) | No addition |
| 1160 | SARGENT XC Large Format Interchangeable Plastic Disposable Construction Core | No addition |
| 1163 | SARGENT XC Large Format Interchangeable Core Cylinder – Includes masterkeying charges | \$77.00 |
| 1164 | SARGENT XC Large Format Interchangeable Construction Core Cylinder | \$77.00 |
| 1170 | Small Format interchangeable disposable construction core - to accept 7 Pin XC permanent core | No addition |
| 11727P | Small Format interchangeable keyed construction core - to accept 7 Pin XC permanent core | \$69.00 |
| 11737P | Small Format interchangeable core - to accept 7 pin XC permanent core | \$69.00 / cyl. |
| 12 | UL Fire Label Exit Devices (not available with 16- & HK options) | \$177.00 |
| 16 | Cylinder lockdown feature in rail (not available with 12-, 57-, AL- options) | \$123.00 |
| 19 | 80 Series pushbar without Lexan touchpad | No addition |
| 21 | SARGENT Construction Key System (lost ball) | \$16.00 / cyl. |
| 22 | SARGENT Construction Key System (split key) | \$32.00 / cyl. |
| 31 | For doors greater than 1-3/4" and up to 2-1/4" (including those with auxiliary controls) | No addition |
| | For doors over 2-1/4" | Consult Factory |
| | For doors with panels (See catalog for ordering details) | No addition |
| 36 | 6 Lobe security head screws | \$88.00 |
| 37 | Spanner head screws | \$58.00 |
| 43 | Flush End Cap | No addition |
| * 53 | Latchbolt Monitor Switch – available with 55, 56, 57, 58, AL options | \$237.00 |
| 54 | Internal Micro Switch in ET Control | \$214.00 |
| * 55 | Signal Switch in Rail | \$223.00 |
| * 56 | Remote Dogging / Latch Retraction (Minimum door width for narrow stile is 26" and wide stile is 28") | \$835.00 |
| * HK56 | Latch Retraction with Hex Key Dogging | \$835.00 |
| * 57 | Delayed Action (Magnet ordered separate) | \$1,302.00 |
| * 58 | Electric Dogging | \$450.00 |
| 59 | Electroguard (Not available with 16, 53, 55, 56, 57, 58, NB prefixes) | \$1,593.00 |
| 60 | SARGENT Large Format Interchangeable Plastic Disposable Construction Core | No addition |
| 63 | SARGENT Large Format Interchangeable Core Cylinder includes master and grandmaster keying charge | \$77.00 /cyl. |
| 64 | SARGENT Large Format Interchangeable Construction Core Cylinder | \$77.00 |
| 6573 | Small Format 6 Pin Uncombined Core | \$59.00 / cyl. |
| 65737P | Small Format 7 Pin Uncombined Core | \$59.00 / cyl. |
| 70 | Small Format Interchangeable Disposable plastic construction core | No addition |
| 72 | Small Format Interchangeable 6-Pin Construction Core (7-pin with 11 option) | \$69.00 |
| 73 | Small Format 6-pin interchangeable core | \$69.00 / cyl. |
| 737P | Small Format 7-pin interchangeable core | \$69.00 / cyl. |
| 76 | Tactile Warning - Milled Outside Lever (Not available with Studio, Coastal and the A Levers) | \$71.00 |
| 81 | Cylinder to accept Keso (83) and Keso F1 (F183) removable core – no core provided | No addition |
| F182 | SARGENT Keso Security, patent pending, cylinder – new key systems | \$84.00 / cyl. |
| F183 | SARGENT Keso Security, patent pending, removable core cylinder – new key systems | \$120.00 / cyl. |
| 82 | SARGENT Keso Security Cylinder (existing key systems only) | \$84.00 / cyl. |
| 83 | SARGENT Keso Security Removable Core Cylinder (existing key systems only) | \$120.00 / cyl. |
| 84 | SARGENT Keso Security Removable Construction Core Cylinder | See CK-18 |
| 85 | Tactile Warning - Abrasive Strip Inside Push Rail | \$93.00 |
| 86 | Tactile Warning - Abrasive Coating Outside Lever | \$43.00 |
| 87 | Tactile Warning - Abrasive Strip on Inside Push Rail & Coating on Outside Lever | \$136.00 |
| * AL | Alarmed (not available with HC, 16, 56 thru 59 options) | \$550.00 |
| BR | SARGENT Bump Resistant Cylinders (N/A w/10, 22, 30, 60, 63, 64, 70, 72, 73, 737P, KESO, SC, SE) | \$23.00 /cyl. |
| CPC | Clear Powder Coat – Recommended for exit devices used in full exterior application and highly corrosive areas with 32 and 32D finishes. | \$214.00 |
| DG1 | Patented Degree DG1 Key System | No Addition |
| DG160 | Hardware prepared for DG1-6300 Lg. Format IC cores, supplied with temporary plastic construction cores | No addition |
| DG163 | Patented Degree DG1 Large Format Interchangeable Core Cylinder - Includes master keying charges | \$77.00 |
| DG164 | Hardware prepared for DG1-6300 Lg. Format IC cores, supplied with temporary keyed construction cores | \$77.00 |
| DG2 | Patented Degree DG2 Key System incorporating a locking sidebar | \$58.00/cyl. |
| DG260 | Hardware prepared for DG2-6300 Lg. Format IC cores, supplied with temporary plastic construction cores | No addition |
| DG263 | Patented Degree DG2 Large Format Interchangeable Core Cylinder - Includes master keying charges | \$135.00 |
| DG264 | Hardware prepared for DG2-6300 Lg. Format IC cores, supplied with temporary keyed construction cores | \$77.00 |
| DG3 | Patented Degree DG3 Key System incorporating a locking sidebar and UL437 listed | \$82.00/cyl. |
| DG360 | Hardware prepared for DG3-6300 Lg. Format IC cores, supplied with temporary plastic construction cores | No addition |
| DG363 | Patented Degree DG3 Large Format Interchangeable Core Cylinder - Includes master keying charges | \$159.00 |
| DG364 | Hardware prepared for DG3-6300 Lg. Format IC cores, supplied with temporary keyed construction cores | \$77.00 |
| LC | Less Cylinder | -\$89.00/cyl. |
| LD | Less Dogging | No addition |
| PL | SARGuide™ PL – Photoluminescent Coating – (Pushbar w/o Lexan Touchpad - 19 option is supplied as standard) | \$348.00 |
| SC | Schlage C Keyway Cylinder 0-Bitted (Rim and #41 Mortise Cylinder) | No addition |
| SE | Schlage E Keyway Cylinder 0-Bitted (Rim and #41 Mortise Cylinder Only) | No addition |
| SG | MicroShield® an antimicrobial powder coat (not available with 10B) | \$82.00 |
| TB | Thru Bolt | \$74.00 |
| * TL | SARGuide™ – Illuminated Touchpad (not available with AL, 57, 59 options) | \$214.00 |
| * Exact door width required when ordering. | | |
| | Vertical Rod Device to 96" Height | No addition |
| | Concealed/Surface Vertical Rod Device over 96" to 120" Height | \$60.00 |
| | Refer to catalog for max. door height availability on fire rated exit devices. | |
| | Vertical Rod Device to 96" Height | No addition |
| 683 Thermal Pin Kit for use with 45/60/90 Minute Wood Doors | | |
| 683 | | \$93.00 |

USA & Canada Prices Effective June 3, 2019



| 8700 Series-Surface Vertical Rod Device, No Bottom Rod | | |
|---|--|--|
|  ET Control |  ET Control |  |
| Standard Levers: A-B-E-F-J-L-P-W Coastal Levers: G-R-S-Y All Studio Collection Levers (Except Gramercy, Wooster Square, & Grant Park) | Gramercy Series: RAG-RAL-RAM-RAS- -RCM-REM-RGM Wooster Square: H001-H002-H003-H004- H005-H006 Grant Park: H007-H008-H009-H010-H011 | 306/313 with Auxiliary 862, 863 Control 864 Pull Price includes 862 Pull (shown) |
| Finishes listed below are for the exit device. Refer to catalog for available trims, trim finishes and how to order. | | |

| NB8700 Series | | | Finish | | | | |
|---------------|------|--------------------------|----------------------|-------------------------------------|----------------------|-------------------------------------|---------------------------|
| | | | 10BE/32D/ BSP/WSP | 03/04/09/ 10/10B/10BL/ 20D/32 | 10BE/32D/ BSP/WSP | 03/04/09/ 10/10B/10BL/ 20D/32 | 10BE/32D/ BSP/WSP |
| NB | 8710 | Exit Only - No Trim | \$2,341.00 | \$2,501.00 | | | |
| NB | 8710 | Dummy Trim (Lever rigid) | \$3,038.00 | \$3,198.00 | \$3,261.00 | \$3,421.00 | \$2,611.00 ▶ \$2,792.00 ▶ |
| *NB | 8710 | Key operates control | | | | | \$3,308.00 \$3,489.00 |
| NB | 8706 | Key operates ET | | | | | |
| NB | 8713 | Key locks/unlocks ET | \$3,038.00 | \$3,198.00 | \$3,261.00 | \$3,421.00 | |
| NB | 8715 | Trim always operable | | | | | |

*When ordering Exits with Auxiliary Control Design, please order as follows: example: NB8710F x 306/313 x 862 x 32D x RHR

| NB8700 Series Freewheeling Trim | | | | | | |
|---------------------------------|------|------------------------------|------------|------------|------------|------------|
| NB | 8740 | Dummy Trim (Lever rotates) | | | | |
| NB | 8743 | Key engages/disengages lever | \$3,038.00 | \$3,198.00 | \$3,261.00 | \$3,421.00 |
| NB | 8746 | Key operates control | | | | |

| NB8700 Series Electro-Mechanical | | | | | | |
|----------------------------------|------|------------------------|------------|------------|------------|------------|
| NB | 8773 | Fail Safe 12v or 24v | | | | |
| NB | 8774 | Fail Secure 12v or 24v | \$3,324.00 | \$3,484.00 | \$3,501.00 | \$3,661.00 |

Note: Specify voltage required when ordering.

863 (18" x 1" Diameter) Pull provided in lieu of 862 (10" x 1" Diameter) Add \$66.00

864 (10" x 3/4" Diameter) Pull provided in lieu of 862 (10" x 1" Diameter) Deduct \$35.00

▶ Dummy Trim includes pull only, Auxiliary Control not supplied.

| Thru Bolt Application | No. Bolts Per Pack | Pack Part # | | Finish |
|-------------------------------------|-----------------------|-------------|------------|--------------|
| | | 1-3/4" Dr. | 2 1/4" Dr. | |
| NB 8700 Rail/Chassis/Case/Guides | 10 | 68-3943 | 68-2289 | \$69.00 Pack |
| 12-NB 8700 Rail/Chassis/Case/Guides | 10 | 68-3943 | 68-2289 | \$69.00 Pack |

NOTES:

Cylinders not included when ordered less trim.

15 or 26D finishes are available on outside trim only, the exit devices will be supplied in 32D.

14 or 26 Finishes are available on outside trim only, the exit devices will be supplied in 32 finish.

FM8700 SERIES OPTIONS

USA & Canada Prices Effective June 3, 2019



| Options | Description | Price |
|---------|---|-----------------|
| 10 | SARGENT Signature System | \$58.00 / cyl. |
| 11 | SARGENT XC Key System (not available w/10, 22, KESO, SC, & SE options) | No addition |
| 1160 | SARGENT XC Large Format Interchangeable Plastic Disposable Construction Core | No addition |
| 1163 | SARGENT XC Large Format Interchangeable Core Cylinder – Includes masterkeying charges | \$77.00 |
| 1164 | SARGENT XC Large Format Interchangeable Construction Core Cylinder | \$77.00 |
| 1170 | Small Format interchangeable disposable construction core - to accept 7 Pin XC permanent core | No addition |
| 11727P | Small Format interchangeable keyed construction core - to accept 7 Pin XC permanent core | \$69.00 |
| 11737P | Small Format interchangeable core - to accept 7 pin XC permanent core | \$69.00 / cyl. |
| 12 | UL fire label Exit Devices | \$177.00 |
| 21 | SARGENT Construction Key System (lost ball) | \$16.00 / cyl. |
| 22 | SARGENT Construction Key System (split key) | \$32.00 / cyl. |
| 36 | 6 Lobe security head screws | \$88.00 |
| 37 | Spanner head screws | \$58.00 |
| 43 | Flush End Cap | No addition |
| * 54 | Internal Micro Switch in ET Control | \$214.00 |
| 60 | SARGENT Large Format Interchangeable Plastic Disposable Construction Core | No addition |
| 63 | SARGENT Large Format Interchangeable Core Cylinder includes master and grandmaster keying charge | \$77.00 / cyl. |
| 64 | SARGENT Large Format Interchangeable Construction Core Cylinder | \$77.00 |
| 6573 | Small Format 6 Pin Uncombined Core | \$59.00 / cyl. |
| 65737P | Small Format 7 Pin Uncombined Core | \$59.00 / cyl. |
| 70 | Small Format Interchangeable Disposable plastic construction core | No addition |
| 72 | Small Format Interchangeable 6-Pin Construction Core (7-pin wth 11 option) | \$69.00 |
| 73 | Small Format 6-pin interchangeable core | \$69.00 / cyl. |
| 737P | Small Format 7-pin interchangeable core | \$69.00 / cyl. |
| 76 | Tactile Warning - Milled Outside Lever (Not available with Studio, Coastal and the A Levers) | \$71.00 |
| 81 | Cylinder to accept Keso (83) and Keso F1 (F183) removable core – no core provided | No addition |
| F182 | SARGENT Keso Security, patent pending, cylinder – new key systems | \$84.00 / cyl. |
| F183 | SARGENT Keso Security, patent pending, removable core cylinder – new key systems | \$120.00 / cyl. |
| 82 | SARGENT Keso Security Cylinder (existing key systems only) | \$84.00 / cyl. |
| 83 | SARGENT Keso Security Removable Core Cylinder (existing key systems only) | \$120.00 / cyl. |
| 84 | SARGENT Keso Security Removable Construction Core Cylinder | See CK-18 |
| 85 | Tactile Warning - Abrasive Strip Inside Push Rail | \$93.00 |
| 86 | Tactile Warning - Abrasive Coating Outside Lever | \$43.00 |
| 87 | Tactile Warning - Abrasive Strip on Inside Push Rail & Coating on Outside Lever | \$136.00 |
| BR | SARGENT Bump Resistant Cylinders (N/A w/10, 22, 30, 60, 63, 64, 70, 72, 73, 737P, KESO, SC, SE) | \$23.00 /cyl. |
| CPC | Clear Powder Coat – Recommended for exit devices used in full exterior application and highly corrosive areas with 32 and 32D finishes. | \$214.00 |
| DG1 | Patented Degree DG1 Key System | No Addition |
| DG160 | Hardware prepared for DG1-6300 Lg. Format IC cores, supplied with temporary plastic construction cores | No addition |
| DG163 | Patented Degree DG1 Large Format Interchangeable Core Cylinder - Includes master keying charges | \$77.00 |
| DG164 | Hardware prepared for DG1-6300 Lg. Format IC cores, supplied with temporary keyed construction cores | \$77.00 |
| DG2 | Patented Degree DG2 Key System incorporating a locking sidebar | \$58.00/cyl. |
| DG260 | Hardware prepared for DG2-6300 Lg. Format IC cores, supplied with temporary plastic construction cores | No addition |
| DG263 | Patented Degree DG2 Large Format Interchangeable Core Cylinder - Includes master keying charges | \$135.00 |
| DG264 | Hardware prepared for DG2-6300 Lg. Format IC cores, supplied with temporary keyed construction cores | \$77.00 |
| DG3 | Patented Degree DG3 Key System incorporating a locking sidebar and UL437 listed | \$82.00/cyl. |
| DG360 | Hardware prepared for DG3-6300 Lg. Format IC cores, supplied with temporary plastic construction cores | No addition |
| DG363 | Patented Degree DG3 Large Format Interchangeable Core Cylinder - Includes master keying charges | \$159.00 |
| DG364 | Hardware prepared for DG3-6300 Lg. Format IC cores, supplied with temporary keyed construction cores | \$77.00 |
| LC | Less Cylinder | -\$89.00/cyl. |
| LD | Less Dogging | No addition |
| SC | Schlage C Keyway Cylinder 0-Bitted (Rim and #41 Mortise Cylinder) | No addition |
| SE | Schlage E Keyway Cylinder 0-Bitted (Rim and #41 Mortise Cylinder Only) | No addition |
| SG | MicroShield® an antimicrobial powder coat (not available with 10B) | \$82.00 |
| TB | Thru Bolt | \$74.00 |

*** Exact door width required when ordering.**

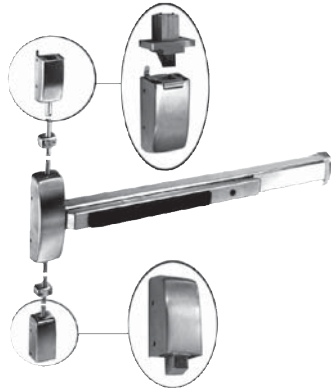
Max Door Height 96"
Available for "E" & "F" rails only



FM8700 Series-Surface Vertical Rod Device – 2 Pt. Latching, complies with FEMA 361

| ET Control | ET Control | |
|---|---|--|
|  |  |  |
| Standard Levers: A-B-E-F-J-L-P-W Coastal Levers: G-R-S-Y All Studio Collection Levers (Except Gramercy, Wooster Square, & Grant Park) | Gramercy Series: RAG-RAL-FAM-RAS- RCM-REM-RGM Wooster Square: H001-H002-H003-H004- H005-H006 Grant Park: H007-H008-H009-H010-H011 | 306/313 with Auxiliary 862, 863 Control 864 Pull Price includes 862 Pull (shown) |
| Finishes listed below are for the exit device. Refer to catalog for available trims, trim finishes and how to order. | | |

| FM8700 Series | | | Finish | | | | | |
|---------------|----------|--------------------------|----------------------|-------------------------------------|----------------------|-------------------------------------|----------------------|-------------------------|
| Option | Function | Description | 10BE/32D/ BSP/WSP | 03/04/ 09/10/10B/ 10BL/20D/32 | 10BE/32D/ BSP/WSP | 03/04/ 09/10/10B/ 10BL/20D/32 | 10BE/32D/ BSP/WSP | 03/04/ 10/10B/ 32 |
| FM | 8710 | Exit Only - No Trim | \$3,477.00 | \$3,637.00 | | | | |
| FM | 8710 | Dummy Trim (Lever rigid) | \$4,174.00 | \$4,334.00 | \$4,397.00 | \$4,557.00 | \$3,747.00 ▶ | \$3,928.00 ▶ |
| *FM | 8710 | Key operates control | | | | | \$4,444.00 | \$4,625.00 |
| FM | 8706 | Key operates ET | | | | | | |
| FM | 8713 | Key locks/unlocks ET | \$4,174.00 | \$4,334.00 | \$4,397.00 | \$4,557.00 | | |
| FM | 8715 | Trim always operable | | | | | | |

*When ordering Exits with Auxiliary Control Design, please order as follows: example: FM8710F x 306/313 x 862 x 32D x RHR

| FM8700 Series With Freewheeling Trim | | | | | | | | |
|---------------------------------------|------|------------------------------|------------|------------|------------|------------|--|--|
| FM | 8740 | Dummy Trim (Lever rotates) | | | | | | |
| FM | 8743 | Key engages/disengages lever | \$4,174.00 | \$4,334.00 | \$4,397.00 | \$4,557.00 | | |
| FM | 8746 | Key operates control | | | | | | |
| FM8700 Series With Electro-Mechanical | | | | | | | | |
| FM | 8773 | Fail Safe 12v or 24v | \$4,460.00 | \$4,620.00 | \$4,637.00 | \$4,797.00 | | |
| FM | 8774 | Fail Secure 12v or 24v | | | | | | |

Note: Specify voltage required when ordering.

863 (18" x 1" Diameter) Pull provided in lieu of 862 (10" x 1" Diameter) Add \$66.00 ▶

864 (10" x 3/4" Diameter) Pull provided in lieu of 862 (10" x 1" Diameter) Deduct \$35.00 ▶

▶ Dummy Trim includes pull only, Auxiliary Control not supplied.

| Thru Bolt Application | | | No. Bolts Per Pack | Pack Part # | | Finish 03/09/10/10B/10BE/10BL/20D/26D/BSP/WSP |
|-----------------------|---------|----------------|-----------------------|-------------|------------|--|
| | | | | 1-3/4" Dr. | 2 1/4" Dr. | |
| FM | 8700 | Rail & Chassis | 4 | 68-2279 | 68-2280 | \$24.00 Pack |
| FM | 8700 | Cases & Guides | 10 | 68-2282 | 68-2283 | \$59.00 Pack |
| FM | 12-8700 | | 16 | 68-2288 | 68-2289 | \$90.00 Pack |

NOTES:

Cylinders not included when ordered less trim.

15 or 26D finishes are available on outside trim only, the exit devices will be supplied in 32D.

14 or 26 Finishes are available on outside trim only, the exit devices will be supplied in 32 finish.

ED-32 EXIT DEVICES

SARGENT®

ASSA ABLOY





8800 SERIES OPTIONS

USA & Canada Prices Effective June

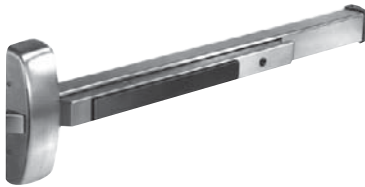
| Options | Description | Price |
|---------|---|---|
| 10 | SARGENT Signature System | \$58.00 / cyl. |
| 11 | SARGENT XC Key System (not available w/10, 22, KESO, SC, & SE options) | No addition |
| 1160 | SARGENT XC Large Format Interchangeable Plastic Disposable Construction Core | No addition |
| 1163 | SARGENT XC Large Format Interchangeable Core Cylinder – Includes masterkeying charges | \$77.00 |
| 1164 | SARGENT XC Large Format Interchangeable Construction Core Cylinder | \$77.00 |
| 1170 | Small Format interchangeable disposable construction core - to accept 7 Pin XC permanent core | No addition |
| 11727P | Small Format interchangeable keyed construction core - to accept 7 Pin XC permanent core | \$69.00 |
| 11737P | Small Format interchangeable core - to accept 7 pin XC permanent core | \$69.00 / cyl. |
| 12 | UL Fire Label Exit Devices (not available with 16- & HK options) | \$177.00 |
| 16 | Cylinder lockdown feature in rail (not available with 12-, 57-, 59-, AL- options) | \$123.00 |
| 19 | 80 Series pushbar without Lexan touchpad | No addition |
| 21 | SARGENT Construction Key System (lost ball) | \$16.00 /cyl. |
| 22 | SARGENT Construction Key System (split key) | \$32.00 /cyl. |
| 31 | For doors greater than 1-3/4" and up to 2-1/4" (including those with auxiliary controls) | No addition |
| | For doors over 2-1/4" | Consult Factory |
| | For doors with panels (See catalog for ordering details) | No addition |
| 36 | 6 Lobe security head screws | \$48.00 |
| 37 | Spanner head screws | \$31.00 |
| 43 | Flush End Cap | No addition |
| 49 | Lock/unlock indicator option (available with 8816 and 8866 functions only) | \$324.00 |
| 5CH | 5lb Pressure Release | \$25.00 |
| * 53 | Latchbolt Monitor Switch – available with 55, 56, 57, 58, AL options | \$237.00 |
| 54 | Internal Micro Switch in ET Control (not available with 04/10 function) | \$214.00 |
| * 55 | Signal Switch in Rail | \$223.00 |
| * 56 | Remote Dogging / Latch Retraction (Minimum door width for narrow stile is 26" and wide stile is 28") | \$835.00 |
| * HK56 | Latch Retraction with Hex Key Dogging | \$835.00 |
| * 57 | Delayed Action (Magnet ordered separate) | \$1,302.00 |
| * 58 | Electric Dogging | \$450.00 |
| * 59 | Electroguard (Not available with 16-, 53-, 55-, 56-, 57-, 58- Options) | \$1,593.00 |
| * BC59 | Electroguard Boca Code (Needs Door Status Switch) (Not available with 16-, 53-, 55-, 56-, 57-, 58- Options) | \$1,695.00 |
| 60 | SARGENT Large Format Interchangeable Plastic Disposable Construction Core | No addition |
| 63 | SARGENT Large Format Interchangeable Core Cylinder includes master and grandmaster keying charge | \$77.00 /cyl. |
| 64 | SARGENT Large Format Interchangeable Construction Core Cylinder | \$77.00 |
| 6573 | Small Format 6 Pin Uncombined Core | \$59.00 / cyl. |
| 65737P | Small Format 7 Pin Uncombined Core | \$59.00 / cyl. |
| 70 | Small Format Interchangeable Disposable plastic construction core | No addition |
| 72 | Small Format Interchangeable 6-Pin Construction Core (7-pin with 11 option) | \$69.00 |
| 73 | Small Format 6-pin interchangeable core | \$69.00 / cyl. |
| 737P | Small Format 7-pin interchangeable core | \$69.00 / cyl. |
| 76 | Tactile Warning - Milled Outside Lever (Not available with Studio, Coastal and the A Levers) | \$71.00 |
| 81 | Cylinder to accept Keso (83) and Keso F1 (F183) removable core – no core provided | No addition |
| F182 | SARGENT Keso Security, patent pending, cylinder – new key systems | \$84.00 / cyl. |
| F183 | SARGENT Keso Security, patent pending, removable core cylinder – new key systems | \$120.00 / cyl. |
| 82 | SARGENT Keso Security Cylinder (existing key systems only) | \$84.00 / cyl. |
| 83 | SARGENT Keso Security Removable Core Cylinder (existing key systems only) | \$120.00 / cyl. |
| 84 | SARGENT Keso Security Removable Construction Core Cylinder | See CK-18 |
| 85 | Tactile Warning - Abrasive Strip Inside Push Rail | \$93.00 |
| 86 | Tactile Warning - Abrasive Coating Outside Lever | \$43.00 |
| 87 | Tactile Warning - Abrasive Strip on Inside Push Rail & Coating on Outside Lever | \$136.00 |
| * AL | Alarmed (not available with 16-, 56- thru 59- options) (minimum Dr width 36") | \$550.00 |
| BR | SARGENT Bump Resistant Cylinders (N/A w/10, 22, 30, 60, 63, 64, 70, 72, 73, 737P, KESO, SC, SE) | \$23.00 /cyl. |
| CPC | Clear Powder Coat – Recommended for exit devices used in full exterior application and highly corrosive areas with 32 and 32D finishes. | \$214.00 |
| DG1 | Patented Degree DG1 Key System | No Addition |
| DG160 | Hardware prepared for DG1-6300 Lg. Format IC cores, supplied with temporary plastic construction cores | No addition |
| DG163 | Patented Degree DG1 Large Format Interchangeable Core Cylinder - Includes master keying charges | \$77.00 |
| DG164 | Hardware prepared for DG1-6300 Lg. Format IC cores, supplied with temporary keyed construction cores | \$77.00 |
| DG2 | Patented Degree DG2 Key System incorporating a locking sidebar | \$58.00/cyl. |
| DG260 | Hardware prepared for DG2-6300 Lg. Format IC cores, supplied with temporary plastic construction cores | No addition |
| DG263 | Patented Degree DG2 Large Format Interchangeable Core Cylinder - Includes master keying charges | \$135.00 |
| DG264 | Hardware prepared for DG2-6300 Lg. Format IC cores, supplied with temporary keyed construction cores | \$77.00 |
| DG3 | Patented Degree DG3 Key System incorporating a locking sidebar and UL437 listed | \$82.00/cyl. |
| DG360 | Hardware prepared for DG3-6300 Lg. Format IC cores, supplied with temporary plastic construction cores | No addition |
| DG363 | Patented Degree DG3 Large Format Interchangeable Core Cylinder - Includes master keying charges | \$159.00 |
| DG364 | Hardware prepared for DG3-6300 Lg. Format IC cores, supplied with temporary keyed construction cores | \$77.00 |
| GL | Guarded Latch (not available with HC or 12-HC) | \$31.00 |
| HC | Hurricane Code (not available with 16, 28, 63, 66 functions) | \$73.00 |
| 12HC | UL Fire Label Hurricane Code (not available with 16, 28, 63, 66 functions) | \$250.00 |
| LC | Less Cylinder | -\$89.00/cyl. |
| LD | Less Dogging | No addition |
| PL | SARGuide™ PL – Photoluminescent Coating – (Pushbar w/o Lexan Touchpad - 19 option is supplied as standard) | \$348.00 |
| SC | Schlage C Keyway Cylinder 0-Bitted (Rim and #41 Mortise Cylinder Only) | No addition |
| SE | Schlage E Keyway Cylinder 0-Bitted (Rim and #41 Mortise Cylinder Only) | No addition |
| SG | MicroShield® an antimicrobial powder coat (not available with 10B) | \$82.00 |
| TB | Thru Bolt | \$24.00 |
| * TL | SARGuide™ – Illuminated Touchpad (not available with AL, 57, 59 options) | \$214.00 |
| WS | Windstorm Certified | No addition 8888 Device and Trims, see pg. ED-37. |

* Exact door width required when ordering.



| 8800 Series-Rim Device | | | |
|---|---|--|--|
|  ET Control Standard Levers: A-B-E-F-J-L-P-W Coastal Levers: G-R-S-Y All Studio Collection Levers (Except Gramercy, Wooster Square, & Grant Park) |  ET Control Gramercy Series: RAG-RAL-RAM-RAS-RCM-REM-RGM Wooster Square: H001-H002-H003-H004-H005-H006 Grant Park: H007-H008-H009-H010-H011 |  PTB STS-MAL-FLL-FLW PSB-MSL-FSL-FSW (04 function only) |  Cylinder included on keyed functions. 862, 863, 864 Pull Price includes 862 Pull (shown) |
| Finishes listed below are for the exit device. Refer to catalog for available trims, trim finishes and how to order. | | | |

| Funct. Description | 8800 Series | | | | | | | | Finish | | | |
|--|----------------------|---------------------------|----------------------|---------------------------|----------------------|---------------------------|----------------------|---------------------------|----------------------|---------------|------------|--|
| | 03/04/ | | 03/04/ | | 03/04/ | | 03/04/ | | 03/04/ | | 03/04/ | |
| | 10BE/32D/ BSP/WSP | 09/10/10B/ 10BL/20D/32 | 10BE/32D/ BSP/WSP | 09/10/10B/ 10BL/20D/32 | 10BE/32D/ BSP/WSP | 09/10/10B/ 10BL/20D/32 | 10BE/32D/ BSP/WSP | 09/10/10B/ 10BL/20D/32 | 10BE/32D/ BSP/WSP | 10/10B/ 32 | | |
| 8810 Exit Only – No Trim | \$1,646.00 | \$1,747.00 | | | | | | | | | | |
| 8810 Dummy Trim (Lever rigid) | | | | | | | | \$2,069.00 | \$2,170.00 | \$1,916.00 | \$2,038.00 | |
| 8804 Key retr. latchbolt (lever rigid) | | | | | | | | | | | | |
| 8806 Key operates ET | \$2,343.00 | \$2,444.00 | \$2,566.00 | \$2,667.00 | | | | | | | | |
| 8813 Key locks/unlocks control | | | | | | | | | | | | |
| 8815 Trim always operable | | | | | | | | | | | | |
| 8816 Key i/s locks/unlocks lever Key o/s retracts latchbolt | \$2,483.00 | \$2,584.00 | \$2,706.00 | \$2,807.00 | | | | | | | | |
| 8828 Thumb piece always operable | | | | | | | | \$2,150.00 | \$2,251.00 | | | |
| 8863 Key locks/unlocks thumb piece | | | | | | | | | | | | |
| 8866 Key i/s locks/unlocks thumb pc. Key o/s retracts latchbolt | | | | | | | | \$2,212.00 | \$2,313.00 | | | |
| 8800 Series With Freewheeling Trim | | | | | | | | | | | | |
| 8840 Dummy Trim (Lever rotates) | | | | | | | | | | | | |
| 8843 Key engages/disengages lever | \$2,343.00 | \$2,444.00 | \$2,566.00 | \$2,667.00 | | | | | | | | |
| 8844 Key retr. litchblt. (Lever rotates) | | | | | | | | | | | | |
| 8846 Key operates ET | | | | | | | | | | | | |
| 8800 Series With Electro-Mechanical | | | | | | | | | | | | |
| 8873 Fail Safe 12v or 24v | | | | | | | | | | | | |
| 8874 Fail Secure 12v or 24v | \$2,629.00 | \$2,730.00 | \$2,806.00 | \$2,907.00 | | | | | | | | |
| 8875 Fail Safe 12v or 24v | | | | | | | | | | | | |
| 8876 Fail Secure 12v or 24v | \$2,864.00 | \$2,965.00 | \$3,032.00 | \$3,133.00 | | | | | | | | |

Note: Specify voltage required when ordering.

863 (18" x 1" Diameter) Pull provided in lieu of 862 (10" x 1" Diameter) Add \$66.00

864 (10" x 3/4" Diameter) Pull provided in lieu of 862 (10" x 1" Diameter) Deduct \$35.00

| Thru Bolt Application | Pack Part # | | | | Finish |
|-----------------------|--------------------|------------|------------|--------------------------------|--------|
| | No. Bolts per Pack | 1-3/4" Dr. | 2 1/4" Dr. | 03/09/10/10B/10BE/10BL/20D/26D | |
| 8800, 12-8800 | 4 | 68-2279 | 68-2280 | \$24.00 Pack | |

NOTES:
 FLW, FSW not available in 32, 32D.
 PSB, MSL, FSL, FSW for use with 8804 function only. Supplied with revised cylinder hole location and thru bolting.
 Cylinder not included when ordered less trim except for 04 function.
15 or 26D finishes are available on outside trim only, the exit devices will be supplied in 32D.
14 or 26 Finishes are available on outside trim only, the exit devices will be supplied in 32 finish.

ED-34 EXIT DEVICES

SARGENT®

ASSA ABLOY

8888 (8810) SERIES OPTIONS

USA & Canada Prices Effective June 3, 2019

| Exit Options | Description | Price |
|--------------|---|---------------|
| 12 | UL Fire Label Exit Devices (not available with 16- option) | \$177.00 |
| 16 | Cylinder lockdown feature (not available with 12- option) | \$123.00 |
| 19 | 80 Series pushbar without Lexan Touchpad | No addition |
| 43 | Flush End Cap | No Addition |
| CPC | Clear Powder Coat – Recommended for exit devices used in full exterior application and highly corrosive areas with 32 and 32D finishes. | \$214.00 |
| GL | Guarded Latch | \$31.00 |
| LC | Less Cylinder | -\$89.00/cyl. |
| LD | Less Dogging (non-fire rated exit devices only) | No Addition |
| PL | SARGuide™ PL – Photoluminescent Coating – (Pushbar w/o Lexan Touchpad - 19 option is supplied as standard) Require handing | \$348.00 |

| Trim Options | Description | Price |
|--------------|---|----------------|
| 10 | SARGENT Signature System | \$58.00 / cyl. |
| 11 | SARGENT XC Key System (not available w/10, 22, KESO, SC, & SE options) | No addition |
| 1160 | SARGENT XC Large Format Interchangeable Plastic Disposable Construction Core | No addition |
| 1163 | SARGENT XC Large Format Interchangeable Core Cylinder – Includes masterkeying charges | \$77.00 |
| 1164 | SARGENT XC Large Format Interchangeable Construction Core Cylinder | \$77.00 |
| 1170 | Small Format interchangeable disposable construction core - to accept 7 Pin XC permanent core | No addition |
| 11727P | Small Format interchangeable keyed construction core - to accept 7 Pin XC permanent core | \$69.00 |
| 11737P | Small Format interchangeable core - to accept 7 pin XC permanent core | \$69.00 / cyl. |
| 21 | SARGENT Construction Key System (lost ball) | \$16.00 /cyl. |
| 22 | SARGENT Construction Key System (split key) | \$32.00 /cyl. |
| 5CH | 5lb. Pressure Release | \$25.00 |
| 60 | SARGENT Large Format Interchangeable Plastic Disposable Construction Core | No addition |
| 63 | SARGENT Large Format Interchangeable Core Cylinder includes master and grandmaster keying charge | \$77.00 /cyl. |
| 64 | SARGENT Large Format Interchangeable Construction Core Cylinder | \$77.00 |
| 6573 | Small Format 6 Pin Uncombined Core | \$59.00 / cyl. |
| 65737P | Small Format 7 Pin Uncombined Core | \$59.00 / cyl. |
| 70 | Small Format Interchangeable Disposable plastic core | No addition |
| 72 | Small Format Interchangeable Cores 6-Pin Construction Core provided (7-pin with 11 option) | \$69.00 |
| 73 | Small Format 6-pin interchangeable core | \$69.00 / cyl. |
| 737P | Small Format 7-pin interchangeable core | \$69.00 / cyl. |
| BR | SARGENT Bump Resistant Cylinders (N/A w/10, 22, 30, 60, 63, 64, 70, 72, 73, 737P, KESO, SC, SE) | \$23.00 /cyl. |
| CPC | Clear Powder Coat – Recommended for exit devices used in full exterior application and highly corrosive areas with 32 and 32D finishes. | \$214.00 |
| LC | Less Cylinder | -\$89.00/cyl. |
| SC | Schlage C Keyway Cylinder 0-Bitted (Rim and #41 Mortise Cylinder Only) | No Addition |
| SE | Schlage E Keyway Cylinder 0-Bitted (Rim and #41 Mortise Cylinder Only) | No Addition |
| SF | L Lever to accept Schlage Large Format Interchangeable Core (supplied less core, tailpiece included) | No Addition |
| SG | MicroShield® an antimicrobial powder coat (not available with 10B) | \$82.00 |
| TB | Thru Bolt | \$24.00 |

Notes:

80 Series 700-ET, 88-LL, LB, LJ, LP Trims Not Available in Stainless Steel.

8888 REVERSIBLE RIM EXIT DEVICE

USA & Canada Prices Effective June 3, 2019

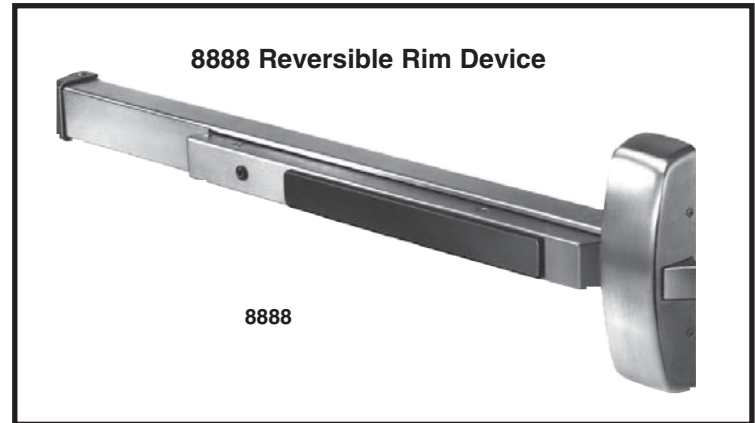

| Device | Finish | |
|--------|------------------|---------------------------------|
| | 10BE/32D/BSP/WSP | 03/04/09/10/10B/ 10BL/20D/32 |
| 8888 | \$1,646.00 | \$1,747.00 |

| 8888 Series Trim | | | |
|-------------------------|--|--------------------------------------|---------------|
| Function | Trim | Description | *All Finishes |
| 704 | - Standard Levers (A, B, E, F, J, L, P, W) | Key retracts latchbolt (Lever rigid) | |
| 710 | - Coastal Levers (C, G, R, S, Y) | Dummy Trim (Lever rigid) | \$697.00 |
| 713-8 | - All Studio Collection levers except Gramercy, Wooster Square, and Grant Park | Key locks/unlocks lever control | |
| 715-8 | | Trim always operable | |
| 704 | - Gramercy Levers: RAG-RAL-RAM-RAS-RCM-REM-RGM | Key retracts latchbolt (Lever rigid) | |
| 710 | - Wooster Sq. Levers: H001-H002-H003-H004- | Dummy Trim (Lever rigid) | \$920.00 |
| 713-8 | H005-H006 | Key locks/unlocks lever control | |
| 715-8 | - Grant Park Levers: H007-H008-H009-H010-H011 | Trim always operable | |
| *88C | Key locks/unlocks trim | LL, LB, LJ, LP | |
| *88D | Dummy Trim | LL, LB, LJ, LP | \$524.00 |
| *88K | Key retracts latchbolt | LL, LB, LJ, LP | |
| *88L | Trim always operable | LL, LB, LJ, LP | |
| 68-0657 | Prep Cover Plate/fits under ET trim (old # 88-E-PTB) | | \$162.00 |
| 810 | Dummy Trim | PTB, STS | |
| 814 | Key retracts latchbolt (04 function) | PSB, MSL, FSL, FSW* | \$423.00 |
| 814 | Key retracts latchbolt | STS | |

| 8888 Series With Freewheeling Trim | | | |
|---|--|--|----------|
| 740 | - Standard Levers (A, B, E, F, J, L, P, W) | Dummy Trim (lever rotates) | |
| 743-8 | - Coastal Levers (C, G, R, S, Y), and All Studio Collection levers except Gramercy, Wooster Square, & Grant Park | Key engages/disengages lever | \$697.00 |
| 744 | | Key retracts latchbolt (lever rotates) | |
| 740 | - Gramercy Levers: RAG-RAL-RAM-RAS-RCM-REM-RGM | Dummy Trim (lever rotates) | |
| 743-8 | - Wooster Sq. Levers: H001-H002-H003-H004-H005-H006 | Key engages/disengages lever | \$920.00 |
| 744 | - Grant Park Levers: H007-H008-H009-H010-H011 | Key retracts latchbolt (lever rotates) | |

Note: Refer to catalog for available trims, trim finishes and how to order.

*FSW, 88C, 88K, 88L, 88D, & ET's not available in 32, 32D.

8900 SERIES OPTIONS



USA & Canada Prices Effective June 3, 2019

| Options | Description | Price |
|---------|---|-----------------|
| 10 | SARGENT Signature System | \$58.00 / cyl. |
| 11 | SARGENT XC Key System (not available w/10, 22, KESO, SC, & SE options) | No addition |
| 1160 | SARGENT XC Large Format Interchangeable Plastic Disposable Construction Core | No addition |
| 1163 | SARGENT XC Large Format Interchangeable Core Cylinder – Includes masterkeying charges | \$77.00 |
| 1164 | SARGENT XC Large Format Interchangeable Construction Core Cylinder | \$77.00 |
| 1170 | Small Format interchangeable disposable construction core - to accept 7 Pin XC permanent core | No addition |
| 11727P | Small Format interchangeable keyed construction core - to accept 7 Pin XC permanent core | \$69.00 |
| 11737P | Small Format interchangeable core - to accept 7 pin XC permanent core | \$69.00 / cyl. |
| 12 | UL Fire Label Exit Devices (not available with 16- & HK options) | \$177.00 |
| 16 | Cylinder lockdown feature in rail (not available with 12-, 57-, 59-, AL- options) | \$123.00 |
| 19 | 80 Series pushbar without Lexan touchpad | No addition |
| 21 | SARGENT Construction Key System (lost ball) | \$16.00 /cyl. |
| 22 | SARGENT Construction Key System (split key) | \$32.00 /cyl. |
| 23 | ANSI flat lip strike (8300, 8900, 9900, Including 12-Option) | No addition |
| 31 | For doors greater than 1-3/4" and up to 2-1/4" (including those with auxiliary controls) | No addition |
| | For doors over 2-1/4" | Consult Factory |
| | For doors with panels (See catalog for ordering details) | No addition |
| 36 | 6 Lobe security head screws | \$52.00 |
| 37 | Spanner head screws | \$34.00 |
| 43 | Flush End Cap | No addition |
| * 53 | Latchbolt Monitor Switch – available with 55, 56, 57, 58, AL options | \$237.00 |
| 54 | Internal Micro Switch in ET Control (not available with 04/10 function) | \$214.00 |
| * 55 | Signal Switch in Rail | \$223.00 |
| * 56 | Remote Dogging / Latch Retraction (Minimum door width for narrow stile is 26" and wide stile is 28") | \$835.00 |
| * HK56 | Latch Retraction with Hex Key Dogging | \$835.00 |
| * 57 | Delayed Action (Magnet ordered separate) | \$1,302.00 |
| * 58 | Electric Dogging | \$450.00 |
| * 59 | Electroguard (Not available with 16-, 53-, 55-, 56-, 57-, 58- Options) | \$1,593.00 |
| * BC59 | Electroguard Boca Code (Needs Door Status Switch) (Not available with 16-, 53-, 55-, 56-, 57-, 58- Options) | \$1,695.00 |
| 60 | SARGENT Large Format Interchangeable Plastic Disposable Construction Core | No addition |
| 63 | SARGENT Large Format Interchangeable Core Cylinder includes master and grandmaster keying charge | \$77.00 /cyl. |
| 64 | SARGENT Large Format Interchangeable Construction Core Cylinder | \$77.00 |
| 6573 | Small Format 6 Pin Uncombined Core | \$59.00 / cyl. |
| 65737P | Small Format 7 Pin Uncombined Core | \$59.00 / cyl. |
| 70 | Small Format Interchangeable Disposable plastic construction core | No addition |
| 72 | Small Format Interchangeable 6-Pin Construction Core (7-pin with 11 option) | \$69.00 |
| 73 | Small Format 6-pin interchangeable core | \$69.00 / cyl. |
| 737P | Small Format 7-pin interchangeable core | \$69.00 / cyl. |
| 76 | Tactile Warning - Milled Outside Lever (Not available with Studio, Coastal and the A Levers) | \$71.00 |
| 81 | Cylinder to accept Keso (83) and Keso F1 (F183) removable core – no core provided | No addition |
| F182 | SARGENT Keso Security, patent pending, cylinder – new key systems | \$84.00 / cyl. |
| F183 | SARGENT Keso Security, patent pending, removable core cylinder – new key systems | \$120.00 / cyl. |
| 82 | SARGENT Keso Security Cylinder (existing key systems only) | \$84.00 / cyl. |
| 83 | SARGENT Keso Security Removable Core Cylinder (existing key systems only) | \$120.00 / cyl. |
| 84 | SARGENT Keso Security Removable Construction Core Cylinder | See CK-18 |
| 85 | Tactile Warning - Abrasive Strip Inside Push Rail | \$93.00 |
| 86 | Tactile Warning - Abrasive Coating Outside Lever | \$43.00 |
| 87 | Tactile Warning - Abrasive Strip on Inside Push Rail & Coating on Outside Lever | \$136.00 |
| * AL | Alarmed (not available with 16-, 56- thru 59- options) (minimum Dr width 36") | \$550.00 |
| BR | SARGENT Bump Resistant Cylinders (N/A w/10, 22, 30, 60, 63, 64, 70, 72, 73, 737P, KESO, SC, SE) | \$23.00 /cyl. |
| CPC | Clear Powder Coat – Recommended for exit devices used in full exterior application and highly corrosive areas with 32 and 32D finishes. | \$214.00 |
| DG1 | Patented Degree DG1 Key System | No Addition |
| DG160 | Hardware prepared for DG1-6300 Lg. Format IC cores, supplied with temporary plastic construction cores | No addition |
| DG163 | Patented Degree DG1 Large Format Interchangeable Core Cylinder - Includes master keying charges | \$77.00 |
| DG164 | Hardware prepared for DG1-6300 Lg. Format IC cores, supplied with temporary keyed construction cores | \$77.00 |
| DG2 | Patented Degree DG2 Key System incorporating a locking sidebar | \$58.00/cyl. |
| DG260 | Hardware prepared for DG2-6300 Lg. Format IC cores, supplied with temporary plastic construction cores | No addition |
| DG263 | Patented Degree DG2 Large Format Interchangeable Core Cylinder - Includes master keying charges | \$135.00 |
| DG264 | Hardware prepared for DG2-6300 Lg. Format IC cores, supplied with temporary keyed construction cores | \$77.00 |
| DG3 | Patented Degree DG3 Key System incorporating a locking sidebar and UL437 listed | \$82.00/cyl. |
| DG360 | Hardware prepared for DG3-6300 Lg. Format IC cores, supplied with temporary plastic construction cores | No addition |
| DG363 | Patented Degree DG3 Large Format Interchangeable Core Cylinder - Includes master keying charges | \$159.00 |
| DG364 | Hardware prepared for DG3-6300 Lg. Format IC cores, supplied with temporary keyed construction cores | \$77.00 |
| LC | Less Cylinder | -\$89.00/cyl. |
| LD | Less Dogging | No addition |
| PL | SARGuide™ PL – Photoluminescent Coating – (Pushbar w/o Lexan Touchpad - 19 option is supplied as standard) | \$348.00 |
| SC | Schlage C Keyway Cylinder 0-Bitted (Rim and #41 Mortise Cylinder Only) | No addition |
| SE | Schlage E Keyway Cylinder 0-Bitted (Rim and #41 Mortise Cylinder Only) | No addition |
| SG | MicroShield® an antimicrobial powder coat (not available with 10B) | \$82.00 |
| * TL | SARGuide™ – Illuminated Touchpad (not available with AL, 57, 59 options) | \$214.00 |
| TB | Thru Bolt | \$24.00 |
| WS | Windstorm Certified | No addition |

* Exact door width required when ordering.

USA & Canada Prices Effective June 3, 2019



| 8900 Series-Mortise Device | | |
|---|---|---|
| ET Control  | ET Control  |  |
| Standard Levers: A-B-E-F-J-L-P-W Coastal Levers: G-R-S-Y All Studio Collection Levers (Except Gramercy, Wooster Square, & Grant Park) | Gramercy Series: RAG-RAL-RAM-RAS- RCM-REM-RGM Wooster Square: H001-H002-H003-H004- H005-H006 Grant Park: H007-H008-H009-H010-H011 | PTB STS-MAL-FLL-FLW |
| Finishes listed below are for the exit device. Refer to catalog for available trims, trim finishes and how to order. | | |

| 8900 Series | | Finish | | | | | |
|--|--|----------------------|---------------------------------|----------------------|---------------------------------|----------------------|---------------------------------|
| Funct. | Description | 10BE/32D/ BSP/WSP | 03/04/09/10/10B/ 10BL/20D/32 | 10BE/32D/ BSP/WSP | 03/04/09/10/10B/ 10BL/20D/32 | 10BE/32D/ BSP/WSP | 03/04/09/10/10B/ 10BL/20D/32 |
| 8910 | Exit Only - No Trim | \$2,317.00 | \$2,470.00 | | | | |
| 8910 | Dummy Trim (Lever rigid) | | | | | \$2,740.00 | \$2,893.00 |
| 8904 | Key retracts latchbolt (Lever rigid) * | | | | | | |
| 8906 | Key operates ET | \$3,014.00 | \$3,167.00 | \$3,237.00 | \$3,390.00 | | |
| 8913 | Key locks/unlocks control | | | | | | |
| 8915 | Trim always operable | | | | | | |
| 8916 | Key inside locks/unlocks lever | \$3,138.00 * | \$3,291.00 * | \$3,361.00 * | \$3,514.00 * | | |
| 8928 | Thumb pc. always operable | | | | | \$2,809.00 | \$2,962.00 |
| 8963 | Key locks/unlocks thumb pc. | | | | | | |
| 8966 | Key inside locks/unlocks thumb pc. | | | | | \$2,871.00 * | \$3,024.00 * |
| 8900 Series With Freewheeling Trim | | | | | | | |
| 8940 | Dummy Trim (Lever rotates) | | | | | | |
| 8943 | Key engages/disengages lever | \$3,014.00 | \$3,167.00 | \$3,237.00 | \$3,390.00 | | |
| 8944 | Key retracts latchbolt (Lever rotates) * | | | | | | |
| 8946 | Key operates ET | | | | | | |
| 8900 Series With Electro-Mechanical | | | | | | | |
| 8973 | Fail Safe 12v or 24v | \$3,300.00 | \$3,453.00 | \$3,477.00 | \$3,630.00 | | |
| 8974 | Fail Secure 12v or 24v | | | | | | |
| 8975 | Fail Safe 12v or 24v | \$3,535.00 * | \$3,688.00 * | \$3,703.00 * | \$3,856.00 * | | |
| 8976 | Fail Secure 12v or 24v | | | | | | |

Note: Specify voltage required when ordering.

| Thru Bolt Application | Pack Part # | | | Finish |
|-----------------------|--------------------|------------|------------|--------------|
| | No. Bolts per pack | 1-3/4" Dr. | 2-1/4" Dr. | |
| 8900 | 4 | 68-2279 | 68-2280 | \$24.00 Pack |

NOTES: Cylinder not included when ordered less trim except for 04 function.
 *Not available with Arrow, Best, Falcon Interchangeable Core Options, SC + SE Cylinders.

15 or 26D finishes are available on outside trim only, the exit devices will be supplied in 32D.

14 or 26 Finishes are available on outside trim only, the exit devices will be supplied in 32 finish.

ED-38 EXIT DEVICES

SARGENT®

9400 SERIES OPTIONS

ASSA ABLOY

USA & Canada Prices Effective June 3, 2019

| Options | Description | Price |
|---------|---|----------------|
| 10 | SARGENT Signature System | \$58.00 / cyl. |
| 11 | SARGENT XC Key System (not available w/10, 22, KESO, SC, & SE options) | No addition |
| 12 | UL Fire Label Exit Devices | \$177.00 |
| 21 | SARGENT Construction Key System (lost ball) | \$16.00 /cyl. |
| 22 | SARGENT Construction Key System (split key) | \$32.00 /cyl. |
| 85 | Tactile Warning - Abrasive Strip Inside Push Rail | \$93.00 |
| BR | SARGENT Bump Resistant Cylinders (N/A w/10, 22, 30, 60, 63, 64, 70, 72, 73, 737P, KESO, SC, SE) | \$23.00 /cyl. |
| LC | Less Cylinder | -\$89.00/cyl. |
| SC | Schlage C Keyway Cylinder 0-Bitted (Rim and #41 Mortise Cylinder Only) | No addition |
| SE | Schlage E Keyway Cylinder 0-Bitted (Rim and #41 Mortise Cylinder Only) | No addition |

9400 Series – Narrow Stile Concealed Vertical Rod



| 9400 Series | | Finish | | |
|-------------|------------------------|------------------|-------------|------------------|
| Function | Description | 10BE/26D/BSP/WSP | 03/04/10/15 | 09/10B/26/32/32D |
| 9410 | Exit Only | \$3,295.00 | \$3,392.00 | \$3,567.00 |
| 9404 | Key retracts latchbolt | \$3,580.00 | \$3,655.00 | \$3,833.00 |

9700 EXIT OPTIONS

USA & Canada Prices Effective June 3, 2019

| Options | Description | Price |
|---------|---|-----------------|
| 10 | SARGENT Signature System | \$58.00 / cyl. |
| 11 | SARGENT XC Key System (not available w/10, 22, KESO, SC, & SE options) | No addition |
| 1160 | SARGENT XC Large Format Interchangeable Plastic Disposable Construction Core | No addition |
| 1163 | SARGENT XC Large Format Interchangeable Core Cylinder – Includes masterkeying charges | \$77.00 |
| 1164 | SARGENT XC Large Format Interchangeable Construction Core Cylinder | \$77.00 |
| 1170 | Small Format interchangeable disposable construction core - to accept 7 Pin XC permanent core | No addition |
| 11727P | Small Format interchangeable keyed construction core - to accept 7 Pin XC permanent core | \$69.00 |
| 11737P | Small Format interchangeable core - to accept 7 pin XC permanent core | \$69.00 / cyl. |
| 12 | UL Fire Label Exit Devices | \$177.00 |
| 14 | Sliding bolt bottom case for 9700 Series | No addition |
| 21 | SARGENT Construction Key System (lost ball) | \$16.00 / cyl. |
| 22 | SARGENT Construction Key System (split key) | \$32.00 / cyl. |
| 31 | For doors greater than 1-3/4" and up to 2-1/4" (including those with auxiliary controls) | No addition |
| | For doors over 2-1/4" | Consult Factory |
| | For doors with panels | Consult Factory |
| 36 | 6 Lobe security head screws | \$97.00 |
| 37 | Spanner head screws | \$64.00 |
| 42 | Reinforced Crossbar | \$71.00 |
| 54 | Internal Micro Switch in ET Control | \$214.00 |
| 60 | SARGENT Large Format Interchangeable Plastic Disposable Construction Core | No addition |
| 63 | SARGENT Large Format Interchangeable Core Cylinder includes master and grandmaster keying charge | \$77.00 / cyl. |
| 64 | SARGENT Large Format Interchangeable Construction Core Cylinder | \$77.00 |
| 6573 | Small Format 6 Pin Uncombined Core | \$59.00 / cyl. |
| 65737P | Small Format 7 Pin Uncombined Core | \$59.00 / cyl. |
| 70 | Small Format Interchangeable Disposable plastic core | No addition |
| 72 | Small Format Interchangeable Cores 6-Pin Construction Core provided (7-pin with 11 Option) | \$69.00 |
| 73 | Small Format 6-pin interchangeable core | \$69.00 / cyl. |
| 737P | Small Format 7-pin interchangeable core | \$69.00 / cyl. |
| 76 | Tactile Warning - Milled Outside Lever (Not available with Studio, Coastal and the A Levers) | \$71.00 |
| 81 | Cylinder to accept Keso (83) and Keso F1 (F183) removable core – no core provided | No addition |
| F182 | SARGENT Keso Security, patent pending, cylinder – new key systems | \$84.00 / cyl. |
| F183 | SARGENT Keso Security, patent pending, removable core cylinder – new key systems | \$120.00 / cyl. |
| 82 | SARGENT Keso Security Cylinder (existing key systems only) | \$84.00 / cyl. |
| 83 | SARGENT Keso Security Removable Core Cylinder (existing key systems only) | \$120.00 / cyl. |
| 84 | SARGENT Keso Security Removable Construction Core Cylinder | See CK-18 |
| 85 | Tactile Warning - Abrasive Strip Inside Push Rail | \$93.00 |
| 86 | Tactile Warning - Abrasive Coating Outside Lever | \$43.00 |
| 87 | Tactile Warning - Abrasive Strip on Inside Push Rail & Coating on Outside Lever | \$136.00 |
| BR | SARGENT Bump Resistant Cylinders (N/A w/10, 22, 30, 60, 63, 64, 70, 72, 73, 737P, KESO, SC, SE) | \$23.00 / cyl. |
| CPC | Clear Powder Coat – Recommended for exit devices used in full exterior application and highly corrosive areas with 32 and 32D finishes. | \$214.00 |
| DG1 | Patented Degree DG1 Key System | No Addition |
| DG160 | Hardware prepared for DG1-6300 Lg. Format IC cores, supplied with temporary plastic construction cores | No addition |
| DG163 | Patented Degree DG1 Large Format Interchangeable Core Cylinder - Includes master keying charges | \$77.00 |
| DG164 | Hardware prepared for DG1-6300 Lg. Format IC cores, supplied with temporary keyed construction cores | \$77.00 |
| DG2 | Patented Degree DG2 Key System incorporating a locking sidebar | \$58.00/cyl. |
| DG260 | Hardware prepared for DG2-6300 Lg. Format IC cores, supplied with temporary plastic construction cores | No addition |
| DG263 | Patented Degree DG2 Large Format Interchangeable Core Cylinder - Includes master keying charges | \$135.00 |
| DG264 | Hardware prepared for DG2-6300 Lg. Format IC cores, supplied with temporary keyed construction cores | \$77.00 |
| DG3 | Patented Degree DG3 Key System incorporating a locking sidebar and UL437 listed | \$82.00/cyl. |
| DG360 | Hardware prepared for DG3-6300 Lg. Format IC cores, supplied with temporary plastic construction cores | No addition |
| DG363 | Patented Degree DG3 Large Format Interchangeable Core Cylinder - Includes master keying charges | \$159.00 |
| DG364 | Hardware prepared for DG3-6300 Lg. Format IC cores, supplied with temporary keyed construction cores | \$77.00 |
| LC | Less Cylinder | -\$89.00/cyl. |
| SC | Schlage C Keyway Cylinder 0-Bitted (Rim and #41 Mortise Cylinder Only) | No addition |
| SE | Schlage E Keyway Cylinder 0-Bitted (Rim and #41 Mortise Cylinder Only) | No addition |
| SG | MicroShield® an antimicrobial powder coat (not available with 10B) | \$82.00 |
| TB | Thru Bolt | \$84.00 |

Vertical Rod Device to 96" Height No addition
 Concealed/Surface Vertical Rod Device over 96" to 120" Height \$60.00
 Center Bearing Bracket for door 48" and over, order using part 98-2162 x finish \$390.36
 Refer to catalog for max. door height availability on fire rated exit devices.



| 9700 Series-Surface Vertical Rod Device | | | |
|---|---|-----------------------------------|---|
| ET Control | ET Control | PTB STS-MAL-FLL-FLW | Auxiliary Control with 862, 863 (306/313) 864 Pull Price includes 862 Pull (shown) |
| Standard Levers: A-B-E-F-J-L-P-W Coastal Levers: G-R-S-Y All Studio Collection Levers (Except Gramercy, Wooster Square, & Grant Park) | Gramercy Series: RAG-RAL-RAM-RAS-RCM-REM-RGM Wooster Square: H001-H002-H003-H004-H005-H006 Grant Park: H007-H008-H009-H010-H011 | | |
| Finishes listed below are for the exit device. Refer to catalog for available trims, trim finishes and how to order. | | | |

| Funct. Description | 9700 Series | | | | | | | |
|------------------------------------|-------------|-------------|------------|-------------|------------|-------------|------------|------------|
| | Finish | | | | | | | |
| | 03/04/ | | 03/04/ | | 03/04/ | | 03/04/ | |
| | 10BE/32D/ | 09/10/10B/ | 10BE/32D/ | 09/10/10B/ | 10BE/32D/ | 09/10/10B/ | 10BE/32D/ | 10/10B/ |
| | BSP/WSP | 10BL/20D/32 | BSP/WSP | 10BL/20D/32 | BSP/WSP | 10BL/20D/32 | BSP/WSP | 32 |
| 9710 Exit Only - No Trim | \$2,470.00 | \$3,074.00 | | | | | | |
| 9710 Dummy Trim | \$3,167.00 | \$3,771.00 | \$3,390.00 | \$3,994.00 | \$2,893.00 | \$3,497.00 | \$2,740.00 | \$3,365.00 |
| *9710 Key Operates Control | | | | | | | \$3,437.00 | \$4,062.00 |
| 9706 Key operates ET | | | | | | | | |
| 9713 Key locks/unlocks ET | \$3,167.00 | \$3,771.00 | \$3,390.00 | \$3,994.00 | | | | |
| 9715 Trim always operable | | | | | | | | |
| 9728 Thumb piece always operable | | | | | \$2,964.00 | \$3,568.00 | | |
| 9763 Key locks/unlocks thumb piece | | | | | | | | |

*When ordering Exits with Auxiliary Control Design, please order as follows: example: 9710 x 306/313 x 862 x 32D x RHR

| 9700 Series With Electro-Mechanical | | | | | | | | |
|-------------------------------------|------------|------------|------------|------------|--|--|--|--|
| 9773 Fail Safe 12v or 24v | \$3,453.00 | \$4,057.00 | \$3,630.00 | \$4,234.00 | | | | |
| 9774 Fail Secure 12v or 24v | | | | | | | | |

Note: Specify voltage required when ordering.

863 (18" x 1" Diameter) Pull provided in lieu of 862 (10" x 1" Diameter) Add \$66.00

864 (10" x 3/4" Diameter) Pull provided in lieu of 862 (10" x 1" Diameter) Deduct \$35.00

PRK design available in 06, 10, 13, 15 functions. (Not available in Stainless Steel.) From ET price deduct \$180.00

| Thru Bolt Application | Pack Part # | | Finish |
|-----------------------|--------------------|------------|--------------|
| | No. Bolts per pack | 1-3/4" Dr. | |
| 9700 | 14 | 97-2579 | \$80.00 Pack |
| 12-9700 | 16 | 97-2965 | \$90.00 Pack |

NOTES:

15 or 26D finishes are available on outside trim only, the exit devices will be supplied in 32D.

14 or 26 Finishes are available on outside trim only, the exit devices will be supplied in 32 finish.

Cylinders not included when ordered less trim.

▶ Dummy Trim includes Pull only, Auxiliary Control not supplied.

9800 SERIES OPTIONS

USA & Canada Prices Effective June 3, 2019

| Options | Description | Price |
|---------|---|-----------------|
| 10 | SARGENT Signature System | \$58.00 / cyl. |
| 11 | SARGENT XC Key System (not available w/10, 22, KESO, SC, & SE options) | No addition |
| 1160 | SARGENT XC Large Format Interchangeable Plastic Disposable Construction Core | No addition |
| 1163 | SARGENT XC Large Format Interchangeable Core Cylinder – Includes masterkeying charges | \$77.00 |
| 1164 | SARGENT XC Large Format Interchangeable Construction Core Cylinder | \$77.00 |
| 1170 | Small Format interchangeable disposable construction core - to accept 7 Pin XC permanent core | No addition |
| 11727P | Small Format interchangeable keyed construction core - to accept 7 Pin XC permanent core | \$69.00 |
| 11737P | Small Format interchangeable core - to accept 7 pin XC permanent core | \$69.00 / cyl. |
| 12 | UL Fire Label Exit Devices | \$177.00 |
| 21 | SARGENT Construction Key System (lost ball) | \$16.00 / cyl. |
| 22 | SARGENT Construction Key System (split key) | \$32.00 / cyl. |
| 31 | For doors up to 2-1/4" | No addition |
| | For doors over 2-1/4" | Consult Factory |
| | For doors with panels | Consult Factory |
| 36 | 6 Lobe security head screws | \$42.00 |
| 37 | Spanner head screws | \$27.00 |
| 42 | Reinforced Crossbar | \$71.00 |
| 54 | Internal Micro Switch in ET Control | \$214.00 |
| 60 | SARGENT Large Format Interchangeable Plastic Disposable Construction Core | No addition |
| 63 | SARGENT Large Format Interchangeable Core Cylinder includes master and grandmaster keying charge | \$77.00 /cyl. |
| 64 | SARGENT Large Format Interchangeable Construction Core Cylinder | \$77.00 |
| 6573 | Small Format 6 Pin Uncombined Core | \$59.00 / cyl. |
| 65737P | Small Format 7 Pin Uncombined Core | \$59.00 / cyl. |
| 70 | Small Format Interchangeable Disposable plastic construction core | No addition |
| 72 | Small Format Interchangeable 6-Pin construction core (7-pin with 11 option) | \$69.00 |
| 73 | Small Format 6-pin interchangeable core | \$69.00 / cyl. |
| 737P | Small Format 7-pin interchangeable core | \$69.00 / cyl. |
| 76 | Tactile Warning - Milled Outside Lever (Not available with Studio, Coastal and the A Levers) | \$71.00 |
| 81 | Cylinder to accept Keso (83) and Keso F1 (F183) removable core – no core provided | No addition |
| F182 | SARGENT Keso Security, patent pending, cylinder – new key systems | \$84.00 / cyl. |
| F183 | SARGENT Keso Security, patent pending, removable core cylinder – new key systems | \$120.00 / cyl. |
| 82 | SARGENT Keso Security Cylinder (existing key systems only) | \$84.00 / cyl. |
| 83 | SARGENT Keso Security Removable Core Cylinder (existing key systems only) | \$120.00 / cyl. |
| 84 | SARGENT Keso Security Removable Construction Core Cylinder | See CK-18 |
| 85 | Tactile Warning - Abrasive Strip Inside Push Rail | \$93.00 |
| 86 | Tactile Warning - Abrasive Coating Outside Lever | \$43.00 |
| 87 | Tactile Warning - Abrasive Strip on Inside Push Rail & Coating on Outside Lever | \$136.00 |
| BR | SARGENT Bump Resistant Cylinders (N/A w/10, 22, 30, 60, 63, 64, 70, 72, 73, 737P, KESO, SC, SE) | \$23.00 /cyl. |
| CPC | Clear Powder Coat – Recommended for exit devices used in full exterior application and highly corrosive areas with 32 and 32D finishes. | \$214.00 |
| DG1 | Patented Degree DG1 Key System | No Addition |
| DG160 | Hardware prepared for DG1-6300 Lg. Format IC cores, supplied with temporary plastic construction cores | No addition |
| DG163 | Patented Degree DG1 Large Format Interchangeable Core Cylinder - Includes master keying charges | \$77.00 |
| DG164 | Hardware prepared for DG1-6300 Lg. Format IC cores, supplied with temporary keyed construction cores | \$77.00 |
| DG2 | Patented Degree DG2 Key System incorporating a locking sidebar | \$58.00/cyl. |
| DG260 | Hardware prepared for DG2-6300 Lg. Format IC cores, supplied with temporary plastic construction cores | No addition |
| DG263 | Patented Degree DG2 Large Format Interchangeable Core Cylinder - Includes master keying charges | \$135.00 |
| DG264 | Hardware prepared for DG2-6300 Lg. Format IC cores, supplied with temporary keyed construction cores | \$77.00 |
| DG3 | Patented Degree DG3 Key System incorporating a locking sidebar and UL437 listed | \$82.00/cyl. |
| DG360 | Hardware prepared for DG3-6300 Lg. Format IC cores, supplied with temporary plastic construction cores | No addition |
| DG363 | Patented Degree DG3 Large Format Interchangeable Core Cylinder - Includes master keying charges | \$159.00 |
| DG364 | Hardware prepared for DG3-6300 Lg. Format IC cores, supplied with temporary keyed construction cores | \$77.00 |
| LC | Less Cylinder | -\$89.00/cyl. |
| SC | Schlage C Keyway Cylinder 0-Bitted (Rim and #41 Mortise Cylinder Only) | No addition |
| SE | Schlage E Keyway Cylinder 0-Bitted (Rim and #41 Mortise Cylinder Only) | No addition |
| SG | MicroShield® an antimicrobial powder coat (not available with 10B) | \$82.00 |
| TB | Thru Bolt | \$24.00 |



9898 Device and Trims see page ED-7.

Center Bearing Bracket for door 48" and over, order using part 98-2162 x finish

\$390.36

**** Not available with Studio Collection lever designs.**



| 9800 Series-Rim Device | | |
|---|--|--|
| ET Control  Standard Levers: A-B-E-F-J-L-P-W Coastal Levers: G-R-S-Y All Studio Collection Levers (Except Gramercy, Wooster Square, & Grant Park) | ET Control  Gramercy Series: RAG-RAL-FAM-RAS-RCM-REM-RGM Wooster Square: H001-H002-H003-H004-H005-H006 Grant Park: H007-H008-H009-H010-H011 |  PTB STS-MAL-FLL-FLW |
| Finishes listed below are for the exit device. Refer to catalog for available trims, trim finishes and how to order. | | |

| 9800 Series | | Finish | | | | |
|--|----------------------|---------------------------------|----------------------|---------------------------------|----------------------|---------------------------------|
| Funct. Description | 10BE/32D/ BSP/WSP | 03/04/09/10/10B/ 10BL/20D/32 | 10BE/32D/ BSP/WSP | 03/04/09/10/10B/ 10BL/20D/32 | 10BE/32D/ BSP/WSP | 03/04/09/10/10B/ 10BL/20D/32 |
| 9810 Exit Only No Trim | \$1,811.00 | \$2,322.00 | | | | |
| 9810 Dummy Trim | | | | | \$2,234.00 | \$2,745.00 |
| 9804 Key retracts latchbolt | \$2,508.00 | \$3,019.00 | \$2,731.00 | \$3,242.00 | | |
| 9813 Key locks/unlocks control | | | | | | |
| 9815 Trim always operable | | | | | | |
| 9828 Thumb pc. always operable | | | | | \$2,305.00 | \$2,816.00 |
| 9863 Key locks/unlocks thumb pc. | | | | | | |
| 9800 Series With Electro-Mechanical | | | | | | |
| 9873* Fail Safe 12v or 24v | \$2,794.00 | \$3,305.00 | \$2,971.00 | \$3,482.00 | | |
| 9874* Fail Secure 12v or 24v | | | | | | |
| 9875* Fail Safe 12v or 24v | \$3,029.00 | \$3,540.00 | \$3,197.00 | \$3,708.00 | | |
| 9876* Fail Secure 12v or 24v | | | | | | |

Note: Specify voltage required when ordering.

PRK design available in 04, 10, 13, 15 functions (Not available in Stainless Steel.)

From ET Price Deduct \$180.00

| Thru Bolt Application | No. Bolts per pack | Pack Part # | Finish |
|-----------------------|--------------------|--------------------|---|
| 9800, 12-9800 | 4 | 1-3/4" Dr. 97-2578 | 03/09/10/10B/10BE/10BL/20D/26D/BSP/WSP \$24.00 Pack |

*9875, *9876 function is not available in 12- option

Cylinder not included when ordered less trim except for 04 function.

NOTES:

15 or 26D finishes are available on outside trim only, the exit devices will be supplied in 32D.

14 or 26 Finishes are available on outside trim only, the exit devices will be supplied in 32 finish.

9900 SERIES OPTIONS

USA & Canada Prices Effective June 3, 2019

| Options | Description | Price |
|---------|---|-----------------|
| 10 | SARGENT Signature System | \$58.00 / cyl. |
| 11 | SARGENT XC Key System (not available w/10, 22, KESO, SC, & SE options) | No addition |
| 1160 | SARGENT XC Large Format Interchangeable Plastic Disposable Construction Core | No addition |
| 1163 | SARGENT XC Large Format Interchangeable Core Cylinder – Includes masterkeying charges | \$77.00 |
| 1164 | SARGENT XC Large Format Interchangeable Construction Core Cylinder | \$77.00 |
| 1170 | Small Format interchangeable disposable construction core - to accept 7 Pin XC permanent core | No addition |
| 11727P | Small Format interchangeable keyed construction core - to accept 7 Pin XC permanent core | \$69.00 |
| 11737P | Small Format interchangeable core - to accept 7 pin XC permanent core | \$69.00 / cyl. |
| 12 | UL Fire Label Exit Devices | \$177.00 |
| 21 | SARGENT Construction Key System (lost ball) | \$16.00 / cyl. |
| 22 | SARGENT Construction Key System (split key) | \$32.00 / cyl. |
| 23 | ANSI Flat Lip Strike (8300, 8900, 9900 including 12- option) | No addition |
| 31 | For doors up to 2-1/4" | No addition |
| | For doors over 2-1/4" | Consult Factory |
| | For doors with panels | Consult Factory |
| 36 | 6 Lobe security head screws | \$48.00 |
| 37 | Spanner head screws | \$31.00 |
| 42 | Reinforced Crossbar | \$71.00 |
| 54 | Internal Micro Switch in ET Control | \$214.00 |
| 60 | SARGENT Large Format Interchangeable Plastic Disposable Construction Core | No addition |
| 63 | SARGENT Large Format Interchangeable Core Cylinder includes master and grandmaster keying charge | \$77.00 /cyl. |
| 64 | SARGENT Large Format Interchangeable Construction Core Cylinder | \$77.00 |
| 6573 | Small Format 6 Pin Uncombined Core | \$59.00 / cyl. |
| 65737P | Small Format 7 Pin Uncombined Core | \$59.00 / cyl. |
| 70 | Small Format Interchangeable Disposable plastic Construction Core | No addition |
| 72 | Small Format Interchangeable 6-Pin Construction Core (7-pin with 11 option) | \$69.00 |
| 73 | Small Format 6-pin interchangeable core | \$69.00 / cyl. |
| 737P | Small Format 7-pin interchangeable core | \$69.00 / cyl. |
| 76 | Tactile Warning - Milled Outside Lever (Not available with Studio, Coastal and the A Levers) | \$71.00 |
| 81 | Cylinder to accept Keso (83) and Keso F1 (F183) removable core – no core provided | No addition |
| F182 | SARGENT Keso Security, patent pending, cylinder – new key systems | \$84.00 / cyl. |
| F183 | SARGENT Keso Security, patent pending, removable core cylinder – new key systems | \$120.00 / cyl. |
| 82 | SARGENT Keso Security Cylinder (existing key systems only) | \$84.00 / cyl. |
| 83 | SARGENT Keso Security Removable Core Cylinder (existing key systems only) | \$120.00 / cyl. |
| 84 | SARGENT Keso Security Removable Construction Core Cylinder | See CK-18 |
| 85 | Tactile Warning - Abrasive Strip Inside Push Rail | \$93.00 |
| 86 | Tactile Warning - Abrasive Coating Outside Lever | \$43.00 |
| 87 | Tactile Warning - Abrasive Strip on Inside Push Rail & Coating on Outside Lever | \$136.00 |
| BR | SARGENT Bump Resistant Cylinders (N/A w/10, 22, 30, 60, 63, 64, 70, 72, 73, 737P, KESO, SC, SE) | \$23.00 /cyl. |
| CPC | Clear Powder Coat – Recommended for exit devices used in full exterior application and highly corrosive areas with 32 and 32D finishes. | \$214.00 |
| DG1 | Patented Degree DG1 Key System | No Addition |
| DG160 | Hardware prepared for DG1-6300 Lg. Format IC cores, supplied with temporary plastic construction cores | No addition |
| DG163 | Patented Degree DG1 Large Format Interchangeable Core Cylinder - Includes master keying charges | \$77.00 |
| DG164 | Hardware prepared for DG1-6300 Lg. Format IC cores, supplied with temporary keyed construction cores | \$77.00 |
| DG2 | Patented Degree DG2 Key System incorporating a locking sidebar | \$58.00/cyl. |
| DG260 | Hardware prepared for DG2-6300 Lg. Format IC cores, supplied with temporary plastic construction cores | No addition |
| DG263 | Patented Degree DG2 Large Format Interchangeable Core Cylinder - Includes master keying charges | \$135.00 |
| DG264 | Hardware prepared for DG2-6300 Lg. Format IC cores, supplied with temporary keyed construction cores | \$77.00 |
| DG3 | Patented Degree DG3 Key System incorporating a locking sidebar and UL437 listed | \$82.00/cyl. |
| DG360 | Hardware prepared for DG3-6300 Lg. Format IC cores, supplied with temporary plastic construction cores | No addition |
| DG363 | Patented Degree DG3 Large Format Interchangeable Core Cylinder - Includes master keying charges | \$159.00 |
| DG364 | Hardware prepared for DG3-6300 Lg. Format IC cores, supplied with temporary keyed construction cores | \$77.00 |
| LC | Less Cylinder | -\$89.00/cyl. |
| SC | Schlage C Keyway Cylinder 0-Bitted (Rim and #41 Mortise Cylinder Only) | No addition |
| SE | Schlage E Keyway Cylinder 0-Bitted (Rim and #41 Mortise Cylinder Only) | No addition |
| SG | MicroShield® an antimicrobial powder coat (not available with 10B) | \$82.00 |
| TB | Thru Bolt | \$24.00 |

SC/SE-Option not available in 04, 75, 76 ET Trim functions

Center Bearing Bracket for door 48" and over, order using part 98-2162 x finish

\$390.36



| 9900 Series-Mortise Device | | |
|---|---|------------------------|
| ET Control | ET Control | PTB |
| Standard Levers: A-B-E-F-J-L-P-W Coastal Levers: G-R-S-Y All Studio Collection Levers (Except Gramercy, Wooster Square, & Grant Park) | Gramercy Series: RAG-RAL-RAM-RAS-RCM-REM-RGM Wooster Square: H001-H002-H003-H004-H005-H006 Grant Park: H007-H008-H009-H010-H011 | STS-MAL-FLL-FLW |
| Finishes listed below are for the exit device. Refer to catalog for available trims, trim finishes and how to order. | | |

| 9900 Series | | Finish | | | | | |
|---------------------------|-------------------------------|----------------------|---------------------------------|----------------------|---------------------------------|----------------------|---------------------------------|
| Funct. | Description | 10BE/32D/ BSP/WSP | 03/04/09/10/10B/ 10BL/20D/32 | 10BE/32D/ BSP/WSP | 03/04/09/10/10B/ 10BL/20D/32 | 10BE/32D/ BSP/WSP | 03/04/09/10/10B/ 10BL/20D/32 |
| 9910 | Exit Only No Trim | \$2,383.00 | \$2,957.00 | | | | |
| 9910 | Dummy Trim | | | | | \$2,806.00 | \$3,380.00 |
| 9904 | Key retracts latchbolt | \$3,080.00 * | \$3,654.00 * | \$3,303.00 * | \$3,877.00 * | | |
| 9913 | Key locks/unlocks control | | | | | | |
| 9915 | Trim always operable | | | | | | |
| 9928 | Thumb piece always operable | | | | | \$2,877.00 | \$3,451.00 |
| 9963 | Key locks/unlocks thumb piece | | | | | | |
| Electro-Mechanical | | | | | | | |
| 9973* | Fail Safe 12v or 24v | \$3,366.00 | \$3,940.00 | \$3,543.00 | \$4,117.00 | | |
| 9974* | Fail Secure 12v or 24v | | | | | | |
| 9975* | Fail Safe 12v or 24v | \$3,601.00 * | \$4,175.00 * | \$3,769.00 * | \$4,343.00 * | | |
| 9976* | Fail Secure 12v or 24v | | | | | | |

Note: Specify voltage required when ordering.

PRK design available in 04, 10, 13, 15 functions (Not available in Stainless Steel.)

From ET price deduct \$180.00

| Thru Bolt Application | Pack Part # | | Finish |
|-----------------------|--------------------|------------|--|
| | No. Bolts per pack | 1-3/4" Dr. | |
| 9900, 12-9900 | 4 | 97-2578 | 03/09/10/10B/10BE/10BL/20D/26D/BSP/WSP \$24.00 Pack |

NOTES:

15 or 26D finishes are available on outside trim only, the exit devices will be supplied in 32D.

14 or 26 Finishes are available on outside trim only, the exit devices will be supplied in 32 finish.

*Not available with Arrow, Best, Falcon Interchangeable Core Options, SC + SE Cylinders.

Cylinder not included when ordered less trim except for 04 function.

ED-46 EXIT DEVICES

SARGENT®

ET LEVER CONTROL TRIM

USA & Canada Prices Effective June 3, 2019



ASSA ABLOY

ET Control

Standard Levers: A-B-E-F-J-L-P-W

Coastal Levers: G-R-S-Y

All Studio Collection Levers
(Except Gramercy, Wooster Square, and Grant Park)

Note: All Exit Trim is priced with cylinder where required. How to order: Trim # x Lever Design – Example: 704ETP x Finish.

700 Series ET Lever Type Trim Function Series (Available as Listed)

| TRIM# | EXITS | Finish |
|---------|--|--|
| | | 03/04/09/10/10B/10BE/10BL/14/15/20D/26/26D/BSP/WSP |
| 704 | 8304, 12-8304, 8504, 8804, 12-8804, 8888, 12-8888, 8904, 12-8904, 9804, 12-9804, 9904, 12-9904 | |
| 706 | 8706, 12-8706, 8906, 9706, 12-9706 | |
| 706-4 | 8406, 12-MD8406, WD8606, 12-WD8606, MD8606, 12-MD8606 | |
| 706-6 | SP8606, PP8606, PR8606, LS8606, LP8606, LR8606 | |
| 706-8 | 8506, SP8706, PP8706, PR8706, 8806, NB8706 | |
| 710 | 8310, 12-8310, 8510, 8710, 12-8710, 8810, 12-8810, 8888, 12-8888, NB8710, 8910, 12-8910, 9710, 12-9710, 9810, 12-9810, 9910, 12-9910, SP8710, PP8710, PR8710 | |
| 710-4 | 8410, 12-MD8410, WD8610, 12-WD8610, MD8610, 12-MD8610 | |
| 710-6 | SP8610, PP8610, PR8610, LS8610, LP8610, LR8610 | |
| 713 | 8313, 12-8313, 8713, 12-8713, 8913, 12-8913, 9713, 12-9713, 9813, 12-9813, 9913, 12-9913 | \$697.00 |
| 713-4 | 8413, 12-MD8413, WD8613, 12-WD8613, MD8613, 12-MD8613 | |
| 713-6 | SP8613, PP8613, PR8613, LS8613, LP8613, LR8613 | |
| 713-8 | 8513, 8888, 12-8888, 8813, 12-8813, SP8713, PP8713, PR8713, NB8713 | |
| 715 | 8315, 12-8315, 8715, 12-8715, 8915, 12-8915, 9715, 12-9715, 9815, 12-9815, 9915, 12-9915 | |
| 715-4 | 8415, 12-MD8415, WD8615, 12-WD8615, MD8615, 12-MD8615 | |
| 715-6 | SP8615, PP8615, PR8615, LS8615, LP8615, LR8615 | |
| 715-8 | 8515, 8888, 12-8888, 8815, 12-8815, SP8715, PP8715, PR8715, NB8715 | |
| 716 | 8816, 12-8816, 8916, 12-8916 | |
| * 773 | 8773, 12-8773, 9773, 12-9773 | |
| * 773-4 | 8473, 12-MD8473, WD8673, 12-WD8673, MD8673, 12-MD8673 | |
| * 773-6 | SP8673, PP8673, PR8673, LS8673, LP8673, LR8673 | |
| * 773-8 | 8573, SP8773, PP8773, PR8773, NB8773, 8873 | |
| * 774 | 8774, 12-8774, 9774, 12-9774 | \$983.00 |
| * 774-4 | 8474, 12-MD8474, WD8674, 12-WD8674, MD8674, 12-MD8674 | |
| * 774-6 | SP8674, PP8674, PR8674, LS8674, LP8674, LR8674 | |
| * 774-8 | 8574, SP8774, PP8774, PR8774, NB8774, 8874 | |
| * 775 | 8375, 12-8375, 8975, 12-8975, 9875, 9975, 12-9975 | |
| * 775-8 | 8875, 12-8875 | \$1,218.00 |
| * 776 | 8376, 12-8376, 8976, 12-8976, 9876, 9976, 12-9976 | |
| * 776-8 | 8876, 12-8876 | |

* Available in 12v or 24v. Please specify voltage required when ordering.

USA & Canada Prices Effective June 3, 2019



Freewheeling ET Control

Standard Levers: A-B-E-F-J-L-P-W

Coastal Levers: G-R-S-Y

**All Studio Collection Levers
(Except Gramercy, Wooster Square,
& Grant Park)**

Note: All Exit Trim is priced with cylinder where required.
How to order: Trim # x Lever Design – Example: 704ETP x Finish.

740 Series Freewheeling ET Lever Type Trim Function Series (Available as Listed)

| TRIM# | EXITS | Finish |
|--------|---|--|
| | | 03/04/09/10/10B/10BE/10BL/14/15/20D/26/26D/BSP/WSP |
| *740 | 8340, 12-8340, 8540, 8740, 12-8740, SP8740, PP8740, PR8740 8840, 12-8840, 8888, 12-8888, 8940, 12-8940, NB8740 | |
| 740-4 | 8440, 12-MD8440, WD8640, 12-WD8640, MD8640, 12-MD8640 | |
| 740-6 | SP8640, PP8640, PR8640, LS8640, LP8640, LR8640 | |
| 743 | 8343, 12-8343, 8743, 12-8743, 8943, 12-8943 | |
| 743-4 | 8443, 12-MD8443, WD8643, 12-WD8643, MD8643, 12-MD8643 | |
| 743-6 | SP8643, PP8643, PR8643, LS8643, LP8643, LR8643 | \$697.00 |
| *743-8 | 8543, 8888, 12-8888, 8843, 12-8843, SP8743, PP8743, PR8743, NB8743 | |
| 744 | 8344, 12-8344, 8544, 8844, 12-8844, 8888, 12-8888, 8944, 12-8944 | |
| 746 | 8746, 12-8746 | |
| 746-4 | 8446, 12-MD8446, WD8646, 12-WD8646, MD8646, 12-MD8646 | |
| 746-6 | SP8646, PP8646, PR8646, LS8646, LP8646, LR8646 | |
| *746-8 | SP8746, PP8746, PR8746, NB8746, 8888, 12-8888, 8846, 12-8846 | |

*Freewheeling trim ordered separately for 8888.

ED-48 EXIT DEVICES

SARGENT®

ASSA ABLOY

ET LEVER CONTROL TRIM

USA & Canada Prices Effective June 3, 2019



ET Control

Gramercy Levers: RAG-RAL-RAM-RAS-RCM-REM-RGM

Wooster Square Levers: H001-H002-H003-H004- H005-H006

Grant Park Levers: H007-H008-H009-H010-H011

Refer to catalog for available trims, finishes and ordering information.

Note: All Exit Trim is priced with cylinder where required.

700 Series ET Lever Type Trim Function Series (Available as Listed)

| TRIM# | EXITS | Finish |
|---------|--|----------------------|
| | | 10BE/BSP/WSP/629/630 |
| 704 | 8304, 12-8304, 8504, 8804, 12-8804, 8888, 12-8888, 8904, 12-8904, 9804, 12-9804, 9904, 12-9904 | |
| 706 | 8706, 12-8706, 8906, 9706, 12-9706 | |
| 706-4 | 8406, 12-MD8406, WD8606, 12-WD8606, MD8606, 12-MD8606 | |
| 706-6 | SP8606, PP8606, PR8606, LS8606, LP8606, LR8606 | |
| 706-8 | 8506, SP8706, PP8706, PR8706, 8806, NB8706 | |
| 710 | 8310, 12-8310, 8510, 8710, 12-8710, 8810, 12-8810, 8888, 12-8888, NB8710, 8910, 12-8910, 9710, 12-9710, 9810, 12-9810, 9910, 12-9910, SP8710, PP8710, PR8710 | |
| 710-4 | 8410, 12-MD8410, WD8610, 12-WD8610, MD8610, 12-MD8610 | |
| 710-6 | SP8610, PP8610, PR8610, LS8610, LP8610, LR8610 | |
| 713 | 8313, 12-8313, 8713, 12-8713, 8913, 12-8913, 9713, 12-9713, 9813, 12-9813, 9913, 12-9913 | \$920.00 |
| 713-4 | 8413, 12-MD8413, WD8613, 12-WD8613, MD8613, 12-MD8613 | |
| 713-6 | SP8613, PP8613, PR8613, LS8613, LP8613, LR8613 | |
| 713-8 | 8513, 8888, 12-8888, 8813, 12-8813, SP8713, PP8713, PR8713, NB8713 | |
| 715 | 8315, 12-8315, 8715, 12-8715, 8915, 12-8915, 9715, 12-9715, 9815, 12-9815, 9915, 12-9915 | |
| 715-4 | 8415, 12-MD8415, WD8615, 12-WD8615, MD8615, 12-MD8615 | |
| 715-6 | SP8615, PP8615, PR8615, LS8615, LP8615, LR8615 | |
| 715-8 | 8515, 8888, 12-8888, 8815, 12-8815, SP8715, PP8715, PR8715, NB8715 | |
| 716 | 8816, 12-8816, 8916, 12-8916 | |
| * 773 | 8773, 12-8773, 9773, 12-9773 | |
| * 773-4 | 8473, 12-MD8473, WD8673, 12-WD8673, MD8673, 12-MD8673 | |
| * 773-6 | SP8673, PP8673, PR8673, LS8673, LP8673, LR8673 | |
| * 773-8 | 8573, SP8773, PP8773, PR8773, NB8773 | |
| * 774 | 8774, 12-8774, 9774, 12-9774 | \$1,160.00 |
| * 774-4 | 8474, 12-MD8474, WD8674, 12-WD8674, MD8674, 12-MD8674 | |
| * 774-6 | SP8674, PP8674, PR8674, LS8674, LP8674, LR8674 | |
| * 774-8 | 8574, SP8774, PP8774, PR8774, NB8774 | |
| * 775 | 8375, 12-8375, 8975, 12-8975, 9875, 9975, 12-9975 | |
| * 775-8 | 8875, 12-8875 | |
| * 776 | 8376, 12-8376, 8976, 12-8976, 9876, 9976, 12-9976 | \$1,386.00 |
| * 776-8 | 8876, 12-8876 | |

* Available in 12v or 24v. Please specify voltage required when ordering.

FREEWHEELING ET LEVER CONTROL TRIM



USA & Canada Prices Effective June 3, 2019

Freewheeling ET Control

Gramercy Levers: RAG-RAL-RAM-RAS-RCM-REM-RGM

Wooster Square Levers: H001-H002-H003-H004- H005-H006

Grant Park Levers: H007-H008-H009-H010-H011

Refer to catalog for available trims, finishes and ordering information.

Note: All Exit Trim is priced with cylinder where required.

740 Series Freewheeling ET Lever Type Trim Function Series (Available as Listed)

| TRIM# | EXITS | Finish |
|---------|---|-------------|
| | | 613/629/630 |
| 740 | 8340, 12-8340, 8540, 8740, 12-8740, SP8740, PP8740, PR8740 8840, 12-8840, 8888, 12-8888, 8940, 12-8940, NB8740 | |
| 740-4 | 8440, 12-MD8440, WD8640, 12-WD8640, MD8640, 12-MD8640 | |
| 740-6 | SP8640, PP8640, PR8640, LS8640, LP8640, LR8640 | |
| 743 | 8343, 12-8343, 8743, 12-8743, 8943, 12-8943 | |
| 743-4 | 8443, 12-MD8443, WD8643, 12-WD8643, MD8643, 12-MD8643 | |
| 743-6 | SP8643, PP8643, PR8643, LS8643, LP8643, LR8643 | \$920.00 |
| * 743-8 | 8543, 8888, 12-8888, 8843, 12-8843, SP8743, PP8743, PR8743, NB8743 | |
| 744 | 8344, 12-8344, 8544, 8844, 12-8844, 8888, 12-8888, 8944, 12-8944 | |
| 746 | 8746, 12-8746 | |
| 746-4 | 8446, 12-MD8446, WD8646, 12-WD8646, MD8646, 12-MD8646 | |
| 746-6 | SP8646, PP8646, PR8646, LS8646, LP8646, LR8646 | |
| 746-8 | SP8746, PP8746, PR8746, NB8746, 8888, 12-8888, 8846, 12-8846 | |

*Freewheeling trim ordered separately for 8888.

ED-50 EXIT DEVICES

SARGENT®

PULL & THUMBPIECE TRIM

ASSA ABLOY

USA & Canada Prices Effective June 3, 2019



| 800 Series Pull & Thumbpiece Trim | | | |
|--|--------------------------|------------------------------|-------------------------------------|
| Function | Trim | Description | All Finishes |
| 802 | PTB | Blank Plate with screw holes | \$287.00 |
| 810 | FLL, FLW, MAL, PTB, STS | 10 | |
| 814 | FLL, FLW, MAL, PTB, STS | 04 | |
| 814 | FSL, FSW, PSB, MSL | *8804/8888 only | \$423.00 |
| 828 | FLL, FLW, MAL, PTB, STS | 28 | |
| 866 | FLL, FLW, MAL, PTB, STS | 62, 63, 66 | |
| 800 Series Offset Pull | | | |
| | | 32 D | 03/04/10/10B/10BE/32/BSP/WSP |
| 862 | 10" Pull – 1" Diameter | \$270.00 | \$291.00 |
| 863 | 18" Pull – 1" Diameter | \$336.00 | \$360.00 |
| 864 | 10" Pull – 3/4" Diameter | \$235.00 | \$255.00 |

FLW, FSW Trim Not Available in 32 & 32D.

*Supplied with revised cylinder hole location and thrubolting.

USA & Canada Prices Effective June 3, 2019

| 80 Series Push Bar Only- No Trim | | Finish | |
|---|--------------------|-------------------------|------------------------------------|
| Function | Description | 10BE/32D/BSP/WSP | 03/04/09/10/10B/10BL/20D/32 |
| 8893 | Inactive Rail | \$806.00 | \$896.00 |
| *8895 | Active Rail | \$870.00 | \$953.00 |

| Thru Bolt Application | | Pack Part # | | Finish |
|---|---------------------------|--------------------|-------------------|---|
| | No. Bolts per pack | 1-3/4" Dr. | 2-1/4" Dr. | 03/04/09/10/10B/10BE/10BL/15/20D/26D/BSP/WSP |
| 8893/8895 (4) | 4 | 68-2279 | 68-2280 | \$24.00 Per Pack |
| Thru Bolts ordered with device | | | | \$6.00 Each |
| *55- For 8895 – Signal Switch in Rail | | | | Add \$223.00 |
| SG is available for 8893 and 8895 MicroShield® an antimicrobial powder coat | | | | Add \$82.00 |



| Anti-Vandal Pull Trim | | Price |
|------------------------------|---|--------------|
| Catalog # | Description | 32 D |
| 821 | used with MD/WD8610, 8710, 8810, 9710, 9810 | |
| 824 | used with 8904, 9904 | |
| 826 | used with 8804 (mfg. after 2/2001) | \$610.00 |
| 827 | used with 8910, 9910 | |



| PRK Design | | Finish | |
|---|----|---|----------|
| (For use w/90 Series Exits Only) | | 03/04/09/10/10B/10BE/10BL/14/15/20D/26/26D/BSP/WSP | |
| 810 PRK | 10 | | |
| 814 PRK | 04 | | \$517.00 |
| 825 PRK | 15 | | |
| ThruBolts are standard | | | |



| Auxiliary Outside Controls | | Finish | |
|--------------------------------------|------------------------------|--|----------|
| No./Series (Avail. as Listed) | | 03/04/09/10/10B/10BE/10BL/14/15/20D/26/26D/32/32D/BSP/WSP | |
| 106 | 8400, WD8600, MD8600 | | |
| 113 | 8400, WD8600, MD8600 | | |
| 306 | 8700, 12-8700, 9700, 12-9700 | | |
| 313 | 8700, 12-8700, 9700, 12-9700 | | \$697.00 |
| NB-306 NB8700 | | | |
| NB-313 NB8700 | | | |

Note: Cannot be used with PP/SP/PR8700 & 8600 Devices.

MULLIONS & ACCESSORIES

USA & Canada Prices Effective June 3, 2019

| Mullions | | | 10B | 28 | Prime Coat |
|----------|-----------|--|------------|------------|------------|
| Option | Catalog # | Description | | | |
| | 650A | Removable Mullion - Alum. Anodized - used w/8500 ser. Exit Device only | \$1,804.00 | \$1,482.00 | |
| | 980 | Removable Mullion - Extruded Aluminum | | | \$683.00 |
| | 980A | Removable Mullion - Aluminum Anodized | \$1,878.00 | \$1,538.00 | |
| | 980S | Removable Mullion - Steel - Non-Fire Rated | | | \$683.00 |
| | HC980 | Hurricane Code Mullion - Steel | | | \$1,018.00 |
| | HCL980 | Lockable Hurricane Code Mullion - Steel | | | \$1,503.00 |
| 12 | 980 | Removable Mullion - Steel - U.L. Fire Rated | | | \$910.00 |
| 12 | HC980 | Hurricane Code Mullion - Steel - U.L. Fire Rated | | | \$1,245.00 |
| 12 | HCL980 | Hurricane Code Lockable Mullion - Steel - U.L. Fire Rated | | | \$1,730.00 |
| 12 | HD980 | UL fire Listed up to 3 hours on 4' x 10' single door applications and 8' x 10' double door applications (w/12-8800 Rim Device) | | | \$1,059.00 |
| | L980 | Lockable Mullion - Aluminum | | | \$1,202.00 |
| | L980A | Lockable Mullion - Aluminum Anodized | \$2,371.00 | \$2,084.00 | |
| | L980S | Lockable Mullion - Steel - Non-Fire Rated | | | \$1,202.00 |
| 12 | L980 | Lockable Mullion - Steel - U.L. Fire Rated | | | \$1,429.00 |
| | EL980 | Lockable Mullion - Steel - Electric - Max height is 96" - consult factory for other. | | | \$1,451.00 |
| | 651 | Mullion Stabilizer Kit - included w/650A Mullion | | | \$51.00 |
| | 988 | Surface Bolt Kit - Used in Hurricane Code applications – Bright Zinc Plated Finish | | | \$148.00 |

Mullion standard stock size is 96". The UL listed products are available as 8' only. This covers all 12- mullions with the exception of 12-HD980 which comes standard at 120".

Mullions Available up to 120" – All mullions over 96" add \$130.00

EL980: Consult Factory

Note: All lockable mullions are supplied less cylinder.

Cylinder must be ordered separately. See below available cylinder options and kits.

| Mullion Cylinder Kits | | | Price |
|-----------------------|--|----------|----------------|
| Option | Description | | |
| 10 | SARGENT Signature System | | \$58.00 |
| 11 | SARGENT XC Key System (not available with 10, 22, SC, SE options) | | No addition |
| 1160 | Sargent XC Large Format Interchangeable Plastic Disposable Construction Core | | No addition |
| 1163 | Sargent XC Large Format Interchangeable Core Cylinder - Includes master keying charges | | \$77.00 |
| 1164 | Sargent XC Large Format Interchangeable Construction Core Cylinder | | \$77.00 |
| 1170 | Small Format interchangeable disposable construction core - to accept 7 Pin XC permanent core | | No addition |
| 11727P | Small Format interchangeable keyed construction core - to accept 7 Pin XC permanent core | | \$69.00 |
| 11737P | Small Format interchangeable core - to accept 7 pin XC permanent core | | \$69.00 |
| 21 | SARGENT Construction Key System (lost ball) | | \$16.00 |
| 22 | Construction Key System (split key) | | \$32.00 |
| 60 | SARGENT Large Format Interchangeable Plastic Disposable Construction Core | | No addition |
| 63 | SARGENT Large Format Interchangeable Core Cylinder includes master and grandmaster keying charge | | \$77.00 |
| 64 | SARGENT Large Format Interchangeable Construction Core Cylinder | | \$77.00 |
| 6573 | Small Format 6-Pin Uncombined Core | | \$59.00 |
| 65737P | Small Format 7-Pin Uncombined Core | | \$59.00 |
| 70 | Small Format interchangeable disposable plastic construction core | | No addition |
| 72 | Small Format interchangeable 6-Pin construction core | | \$69.00 |
| 73 | Small Format interchangeable core 6-pin | | \$69.00 |
| 737P | Small Format interchangeable core 7-pin | | \$69.00 |
| 81 | Cylinder to accept KESO and KESO F1 removable core - no core provided | | No Addition |
| F182 | SARGENT KESO F1 Security Cylinder (Patented) | | \$84.00 |
| 82 | SARGENT KESO Security Cylinder (existing Key Systems only) | | \$84.00 |
| F183 | SARGENT KESO Security Cylinder removable core key system - Patented | | \$120.00 |
| 83 | SARGENT KESO Security Cylinder removable core key system | \$120.00 | |
| 84 | SARGENT KESO Security Cylinder construction removable core system | | See page CK-18 |
| BR | SARGENT Bump Resistant Cyls. (N/A w/10, 22, 30, 60, 63, 64, 70, 72, 73, 737P, KESO, SC, & SE prefixes) | | \$23.00 |
| DG1 | Patented Degree DG1 Key System | | No Addition |
| DG160 | Hardware prepared for DG1-6300 Lg. Format IC cores, supplied with temporary plastic construction cores | | No addition |
| DG163 | Patented Degree DG1 Large Format Interchangeable Core Cylinder - Includes master keying charges | | \$77.00 |
| DG164 | Hardware prepared for DG1-6300 Lg. Format IC cores, supplied with temporary keyed construction cores | | \$77.00 |
| DG2 | Patented Degree DG2 Key System incorporating a locking sidebar | | \$58.00/cyl. |
| DG260 | Hardware prepared for DG2-6300 Lg. Format IC cores, supplied with temporary plastic construction cores | | No addition |
| DG263 | Patented Degree DG2 Large Format Interchangeable Core Cylinder - Includes master keying charges | | \$135.00 |
| DG264 | Hardware prepared for DG2-6300 Lg. Format IC cores, supplied with temporary keyed construction cores | | \$77.00 |
| DG3 | Patented Degree DG3 Key System incorporating a locking sidebar and UL437 listed | | \$82.00/cyl. |
| DG360 | Hardware prepared for DG3-6300 Lg. Format IC cores, supplied with temporary plastic construction cores | | No addition |
| DG363 | Patented Degree DG3 Large Format Interchangeable Core Cylinder - Includes master keying charges | | \$159.00 |
| DG364 | Hardware prepared for DG3-6300 Lg. Format IC cores, supplied with temporary keyed construction cores | | \$77.00 |
| SC | Schlage "C" keyway cylinder 0- bitted only | | No Addition |
| SE | Schlage "E" keyway cylinder 0- bitted only | | No Addition |

USA & Canada Prices Effective June 3, 2019

| Mullion Cylinder Kits | | |
|--------------------------------------|--|--------------|
| Catalog# | Description | Price |
| 980C1 | Steel & aluminum mullions (HCL980, 12-HCL980, L980S, L980, 12-L980, L980A) | \$89.00 |
| 980C2 | Electric mullion (EL980) | |
| Mullion Accessories and Parts | | |
| 502 | Bottom Retainer Pack for 980 | \$155.00 |
| 507 | Adaptor for narrow transom bars (Aluminum x prime) for 980 | \$56.00 |
| 507A | Adaptor for narrow transom bars (Aluminum x anodized) for 980A | \$81.00 |
| 511 | Top Retainer Pack for 980 | \$150.00 |
| 601 | Top Retainer Shim Kit for All Steel Mullions | \$51.00 |
| RK980 | Latchbolt Assembly Retrofit Kit (Includes Top & Bottom Retainers for L980, converts 980 to L980) | \$646.00 |
| 94-2050 | Top Retainer Pack for 650A | \$136.76 |
| 94-2051 | Bottom Retainer Pack for 650A | \$136.76 |
| 98-2190 | Top Retainer Pack for 12-980 | \$177.78 |
| 98-2191 | Bottom Retainer Pack for 12-980 | \$117.65 |
| 98-2525 | Bottom Retainer Pack for L980 | \$117.65 |
| 98-2526 | Top Retainer Pack for L980 | \$117.65 |
| 98-2556 | Bottom Retainer Pack for 12-L980 | \$117.65 |
| 98-2558 | Top Retainer Pack for EL980 | \$177.78 |
| 98-2559 | Top Retainer Pack for 12-L980 | \$177.78 |
| 98-2578 | Wall Mounting Kit for L980 | \$181.62 |
| 98-2579 | Wall Mounting Kit for L980S | \$262.19 |
| 98-2580 | Wall Mounting Kit for EL980 | \$262.19 |
| 98-2599 | Top Retainer Pack for HC980, 12-HC980, and 12-HD980 | \$188.01 |
| 98-2593 | Top Retainer Pack for HCL980 & 12-HCL980 | \$188.01 |
| 98-2594 | Bottom Retainer Pack for HCL980 & 12-HCL980 | \$188.01 |
| 98-2600 | Bottom Retainer Pack for HC980, 12-HC980, and 12-HD980 | \$188.01 |

ED-54 EXIT DEVICES

SARGENT®

ACCESSORIES

ASSA ABLOY

USA & Canada Prices Effective June 3, 2019

| Door Coordinators | | 10/26D |
|--|---|--|
| 3487 | Door Coordinator (6-3/4") | \$497.00 |
| Exit Device Mortise Locks (less cylinders) | | Finish |
| | | 03/04/09/10/10B/10BE/10BL/15/20D/26/26D/BSP/WSP |
| 904, 906, 910, 913, 915, 916, 928, 940, 943, 944, 946, 963, 966, 973, 974, 975, 976, 977, 978 – specify hand when ordering | | \$598.00 |
| Cylinder Dogging Kits (30/80 Series) | | 03/04/09/10/10B/10BE/10BL/20D/32/32D/EN/EB/ED/BSP/WSP |
| 816-1 | For use with Wide Stile F Rail | |
| 816-2 | For use with Narrow Stile E & F Rail | |
| 816-3 | For use with Wide Stile G Rail | |
| 816-4 | For use with Narrow Stile G Rail and Wide Stile J Rail | \$183.00 |
| 816-5 | For use with Wide Stile E Rail | |
| 816-6 | For use with Narrow Stile J rail | |
| Vertical Rod Extension | | 03/04/09/10/10B/10BE/10BL/20D/26/26D/32/32D/EN/EB/ED/BSP/WSP |
| 570 | Rod Connector Kit (68-2745) – No finish required | \$43.00 |
| 571-6 | 6" Rod Extension Kit for 9700/2700/3700 (old style 8700) | \$82.00 |
| 571-12 | 12" Rod Extension Kit for 9700/2700/3700 (old style 8700) | \$103.00 |
| 571-18 | 18" Rod Extension Kit for 9700/2700/3700 (old style 8700) | \$119.00 |
| New Top Rods, New Style 8700 SVR Devices | | |
| 687-6 | Top Rod for 8700 41" AFF – 90" Door (new style 8700's), PP/PR/SP8700 | \$89.00 |
| 687-12 | Top Rod for 8700 41" AFF – 96" Door (new style 8700's), PP/PR/SP8700 | \$103.00 |
| 687-18 | Top Rod for 8700 41" AFF – 102" Door (new style 8700's), PP/PR/SP8700 | \$119.00 |
| *Glass Bead Shim Kits (1/4" thick) | | ED/EN/EB/EP/EAB/ERD |
| 529 | For 12-3727 | \$165.00 |
| 537 | For 12-8700, NB8700, 12-NB8700 (N/A in ED & ERD) | \$166.00 |
| 553 | For Flush End Cap (N/A in ED & ERD) | \$89.00 |
| 558 | For 3828 and 12-3828 | \$146.00 |
| 559 | For 3727 | \$170.00 |
| 568 | For 2828 and 12-2828 (N/A in EP & ERD) | \$146.00 |
| 569 | For FM8700 | \$172.00 |
| 587 | For 8700 | \$172.00 |
| 588 | For 2727 | \$178.00 |
| 589 | For 8600, 12-8600, 8800, 12-8800, 8900, 12-8900 | \$136.00 |
| 668 | For 12-8300, 12-8400, 8500 | \$129.00 |
| 598 | For 12-2727 | \$178.00 |
| *Note: Shim kits may offset outside trim. Longer spindles and thru bolts may be required. Consult factory. | | |
| Security Shim Kit | | |
| 541 | Shim Kit | \$213.00 |
| Stock Hollow Metal Door Kit | | |
| 543 | Stock Hollow Metal Door Kit | \$47.00 |
| AL-Retrofit Kit | | Finish |
| (Used to modify existing exit devices to Alarmed- for 8300, 8500, MD/WD 8600, 8700, and 8900 only) | | 03/04/09/10/10B/10BE/10BL/20D/32/32D/BSP/WSP |
| 545-1 | For use with 8F Wide Rails | |
| 545-2 | For use with 8F & 8E Narrow Rails | |
| 545-3 | For use with 8G Wide Rails | |
| 545-4 | For use with 8G Narrow | \$698.00 |
| 545-6 | For use with 8J Narrow Rails | |
| 545-7 | For use with 8J Wide | |
| Note: Cylinder not included; order cylinder separately. | | |
| Options For Push Rail Assembly Kit | | Add |
| 19 | Pushbar without Lexan Touchpad | No Addition |
| HK | Hex Key Dogging | No Addition |
| 55 | Signal Switch | \$223.00 |
| SG | MicroShield® an antimicrobial powder coat (not available with 10B) | \$82.00 |
| Push Rail Assembly Kit | | Finish |
| | | 03/04/09/10/10B/10BE/10BL/20D/32/32D/BSP/WSP |
| R56A* | Retrofits standard mechanical rail | |
| R56B* | Retrofits 53- Exit Devices. Does not include 53- signal switch. | \$1,333.00 |
| * Please specify rail length (E, F, G, J) and finish. | | |
| How To Order: R56A (Kit #) x F (Rail Size) x 32D (Finish) | | |
| Motor Assembly Kit (Can be added to 80 Series Devices** mfg. after 2006 & P Series Exit Device) | | |
| M56A | Retrofits standard mechanical rail | \$835.00 |
| M56B | Retrofits 53- Exit Devices. Does not include 53- Signal Switch | |
| Note: Please specify rail length. Only 55- option is available with the M56 kits. | | |
| **Motor Retrofit Kits are not available on FM8700 Series Exit Devices | | |
| How To Order: M56A (Kit #) x F (Rail Size) | | |

| Touch Pad | | Black |
|-----------|----------------------------------|---------|
| 809 | Lexan Touchpad for 80 series | \$38.00 |
| 807 | SARGuide™ – Lamp Replacement Kit | \$78.00 |

| Miscellaneous | | |
|---------------|---|----------|
| *565 | Metal End Cap Kit | \$62.00 |
| 576 | Bottom Pullman Bolt Conversion Kit | \$322.00 |
| *665 | Flush end Cap | \$62.00 |
| 584K | Wood Door Kit | \$71.00 |
| *981 | Cross Bar Replacement Kit for 90 Series (except for 9400) | \$343.43 |

607 ET Locking Slide Replacement Kits – Kits include a new screw, lead washer, spring and locking slide. Retrofits to all existing trims.

| Part # | | Price |
|--------|--|----------|
| 607-1 | For all 713 Lockable ET Controls | |
| 607-2 | For all 706 Lockable ET Controls | |
| 607-3 | For all 743 Freewheeling ET Controls | \$108.00 |
| 607-4 | For all 746 Freewheeling ET Controls | |
| 607-5 | For all 746-6 Freewheeling ET Controls | |

730 Retrofit Kits – ET Spindle Retrofit Kit – Includes Spindle, Retainer Plate, Screw & Washer

| Part # | | Price |
|--------|----------------------------------|---------|
| 730-1 | 700 Series Spindle 1-3/4" Door | |
| 730-2 | 700 Series Spindle 2" Door | |
| 730-3 | 700 Series Spindle 2-1/4" Door | |
| 730-4 | 700-4 Series Spindle 1-3/4" Door | |
| 730-5 | 700-4 Series Spindle 2" Door | \$49.00 |
| 730-6 | 700-4 Series Spindle 2-1/4" Door | |
| 730-7 | 700-8 Series Spindle 1-3/4" Door | |
| 730-8 | 700-8 Series Spindle 2" Door | |
| 730-9 | 700-8 Series Spindle 2-1/4" Door | |

Top Rod Kits (Door and Mounting Heights Are Required)

| Part # | | Price |
|---------|--------------------------------|----------|
| MD660T | AD8400, AD8600, MD8400, MD8600 | \$49.00 |
| WD660T | WD8600 | \$49.00 |
| WDA660T | WD8600 x Aux | \$49.00 |
| 661P | PP/PR/SP8600 | \$43.00 |
| 661L | LP/LR/LS8600 | \$36.00 |
| *670T | 8700, and 9700 | \$101.00 |
| *672T | 2700 and 3700 | \$121.00 |
| 692P | PP,PR,SP8600 | \$85.00 |
| MD691T | Top Rod for MD8600 | \$85.00 |
| WD691T | WD8600 | \$85.00 |
| WDA691T | Aux Control WD8600 | \$85.00 |

Bottom Rod Kits (Mounting Height is Required)

| Part # | | Price |
|--------|--|----------|
| 660B | AD8400, MD8400, AD8600, MD8600, WD8600, & WD8600 x Aux | \$42.78 |
| *670B | 8700, and 9700 | \$100.08 |
| *672B | 2700 and 3700 | \$119.49 |
| 691B | AD8400, MD8400, MD8600 & WD8600 | \$67.27 |

| ET Trim Retrofit Kit | | 03/04/09/10/10B/10BE/ 15/20D/26/26D/BSP/WSP |
|-----------------------|---|--|
| Part # | Description | |
| 688 | Retrofit Kit – used with 700 Series ET trim for direct bolt-on to existing Von Duprin preps | \$116.00 |
| Note: *Require finish | | |

ED-56 EXIT DEVICES

SARGENT®

STRIKES

ASSA ABLOY

USA & Canada Prices Effective June 3, 2019

| Part Number | Description | Black Nylon Coated |
|-------------|--|--------------------|
| 606 | Standard Bottom Strike - 12-MD8400, (12)MD8600, (12)WD8600 | \$58.82 |
| 613 | Alternate Half Mortise Strike - 2828, 3828, 8800, 9800 | \$84.05 |
| 624 | Standard Bottom Strike - 2727, 3727, 8700, 9700 | \$58.82 |
| 639 | Top Strike for Aluminum frame Concealed Vertical Rod | \$17.27 |
| 640 | Top & Bottom Strike - AD8400 & AD8600 | \$34.53 |
| 642 | Full Mortise Strike - 2828, 3828, 8800, 9800 | \$58.82 |
| 644 | Surface or Double Dr Strike 2828, 3828, 8800, 9800 | \$76.13 |
| 646 | Top Strike - (12)2727, (12)3727, (12)(14)(NB)8700, (12)(14)9700 | \$79.59 |
| 648 | Flush Panel Strike - 2727, 3727, 8700, 9700 | \$86.52 |
| 649 | Standard Strike - (12)2828, (12)3828, 5100, (12)5800, 8500, (12)8800, (12)8888, (12)9800, (12)9898 | \$81.34 |
| 650 | Standard Top Strike - (12)(NB)MD8400, (12)(NB)MD8600, (12)WD8600 | \$34.59 |
| 652 | Standard Top & Bottom Strike MD8400, MD8600, WD8600" | \$69.21 |
| 653 | Alternate Bottom Strike - 12-2727, 12-3727, 12-8700, 12-9700 | \$117.66 |
| 654 | Top Plate - 12-2727, 12-3727, 12-8700, (12)HC8700 | \$122.78 |
| 655 | Standard Bottom Strike 12-2727, 12-3727, 12-8700, (12)HC8700, 12-9700, 12-9700, 14-8700, 14-9700 | \$34.59 |
| 656 | Alternate Bottom Strike - 2727, 3727, 8700, 9700 | \$34.59 |
| 657 | Standard Strike - 8500(single door) | \$110.75 |
| 658 | Standard Strike - 650A mullion | \$58.82 |
| 658 | Alternate Strike - 8500, 8800 | \$58.82 |
| 659 | Top Strike | \$122.55 |
| ** 815 | Open Back Strike - 8300, 8900, 9900 - for door thickness over 1-3/4", consult factory | \$81.32 |
| 908 | Flat lip strike 8300, 8900, 9900 | \$32.96 |
| ** C908 | Curved lip strike 8300, 8900, 9900 - for door thickness over 2-1/4", consult factory | \$34.59 |
| 608 | Flush Panel Adaptor - 12-8700, 12-9700 | \$110.75 |
| 68-1183 | Double lipped mortise strike LR8600, PR8600, PR8700 | \$88.00 |
| C7710 | Mortise center case strike LS8600, SP8600, SP8700 | \$37.91 |

** When ordering, specify hand (RHR or LHR)

| Part Number | Description | Prime Coat Gray |
|-------------|---------------------|-----------------|
| 98-0036 | Shim for 649 Strike | \$24.97 |

USA & Canada Prices Effective June 3, 2019

| Part No. | Price | Part No. | Price |
|---|---------|---|----------|
| 01-0007 Groove Pin | \$0.97 | *01-3192 #10-24 x 3/4" machine screw | \$0.97 |
| 01-0008 Groove Pin | \$0.97 | 01-3384 #8-32 x 7/16" Ph. Fl. Mach. Screw | \$0.97 |
| 01-0009 Groove Pin | \$3.30 | *01-3454 1/4" - 20 x 1-1/4" machine screw | \$2.18 |
| 01-0011 Lock Washer | \$0.64 | *01-3458 1/4" - 20 x 2-1/4" machine screw | \$1.68 |
| 01-0013 Machine Screw | \$1.29 | 01-3563 01-3563 #5- 40 x 1/4" machine screw | \$0.97 |
| 01-0014 Screw | \$2.56 | 01-3565 #5- 40 x 3/8" machine screw | \$1.29 |
| 01-0048 Roll Pin | \$0.97 | 01-3579 6-32 x 1/16" Ph. Rd. Hd. screw | \$0.59 |
| 01-0074 Retaining Ring | \$0.97 | 01-3582 #6-32 x 3/8" machine screw | \$0.97 |
| 01-0084 Retaining Ring | \$0.97 | *01-3595 #8-32 x 1/4" machine screw | \$0.97 |
| 01-0098 Retaining Ring | \$0.97 | 01-3622 #10-24 x 3/4" machine screw | \$1.66 |
| 01-0204 5/22" washer | \$0.97 | 01-4011 #6-32 x 5/16" machine screw | \$0.59 |
| *01-0225 C -sunk washers (TB mounting) | \$3.68 | 01-4195 4-40 x 3/8" machine screw | \$0.59 |
| 01-0227 15/64" lock washer | \$0.64 | 01-4372 Thru bolts 2" Dr. 700, 700-5, 716 ET | \$4.77 |
| 01-0273 Roll Pin | \$0.97 | 01-4373 Thru bolts 2" 1/4" Dr. 700, 700-5, 716 ET | \$5.08 |
| 01-0288 Socket screw key | \$3.86 | 01-4383 Machine Screw | \$0.49 |
| 01-0401 Spiral Pin | \$2.02 | 01-4442 #10-24 x 1-5/8" machine screw | \$1.29 |
| 01-0402 Roll Pin | \$0.97 | *01-4445 1/4" - 20 x 1-1/2" machine screw | \$1.66 |
| 01-0408 Washer | \$0.97 | 01-4451 Thru bolts 1-3/4" Dr. 700, 700-5, 700-1, 716 ET | \$1.68 |
| 01-0461 Spiral Pin | \$1.29 | 01-4464 Screw for FW Trim | \$1.56 |
| 01-0476 Nyliner | \$0.90 | 01-4507 Groove Pin | \$0.56 |
| 01-0496 Cable clamp | \$0.90 | 01-4537 Standard Hole Plug | \$0.54 |
| 01-0507 Cable clamp | \$1.24 | 01-5001 #10-24 x 3/4" combination screw | \$1.11 |
| 01-0550 Lead washer | \$3.86 | 01-9342 SCREW 10-24 X 2 1/2 | \$1.31 |
| 01-0610 Wave Spring Washer | \$2.56 | *08-4320 Plain knob assembly | \$77.23 |
| 01-0669 3/8" - 16 UNC flex lock nut | \$3.86 | 13-0074 Screw | \$0.66 |
| 01-0695 Spiral Pin | \$1.27 | 13-0075 Rim cylinder connecting screw 2-1/4" | \$1.70 |
| 01-0696 Spiral Pin | \$0.97 | 13-0080 Rim cylinder barrel retainer | \$1.54 |
| 01-0697 Spiral Pin | \$0.97 | 13-0085 Rim cylinder locking tail | \$1.54 |
| 01-0700 "O" Ring | \$3.15 | 13-0086 Rim cylinder back plate | \$2.25 |
| 01-0701 Spiral Pin | \$1.90 | 13-0180 ET rail cylinder nut | \$3.86 |
| 01-0704 Socket Head Set Screw | \$1.66 | 13-0664 Slotted cam | \$4.91 |
| 01-0710 Washer (.012" thick) | \$0.97 | 13-2099 Cylinder Retainer Pack for 8504/8544 functions | \$28.28 |
| 01-0711 Flanged Nyliner | \$1.66 | 13-2162 Cylinder Attachment RH | \$65.35 |
| 01-0712 Rubber Bumper | \$1.25 | *21-0165 Grip | \$184.80 |
| 01-0715 Lock Washer | \$0.97 | *28-0005 2710 & 2727 Cover | \$49.02 |
| 01-0749 Groove Pin | \$0.97 | *28-0006 2828 Cover | \$49.02 |
| 01-0766 Hex Machine Screw Nut | \$0.64 | *28-0018 Push Rail "E" | \$113.76 |
| 01-0797 Spiral Pin | \$2.02 | *28-0019 Push Rail "F" | \$113.76 |
| 01-0836 Spiral Pin 1/8" x 7/8" HDP | \$1.11 | *28-0021 Push Rail "G" | \$113.76 |
| 01-1095 Set Screw | \$0.64 | 28-0026 Pivot Pin | \$5.77 |
| 01-1121 #3-48 x 5/16" fl. hd. mach. screw (Price/Pack - 100 screws) | \$28.35 | 28-0033 Main slide pin | \$5.71 |
| 01-1137 Screw #8-32 x 7/16" | \$1.29 | 28-0035 Main slide | \$68.64 |
| *01-1141 8-32 x 3/8" Ph. Machine Screw | \$1.29 | 28-0036 Lift lever | \$29.39 |
| 01-1142 8-32 x UNC - 2A x 1/4" Screw | \$0.72 | 28-0037 Slide guide pin | \$2.49 |
| 01-1145 #4-40 x 1/4" Ph. Mach. Screw | \$0.90 | 28-0038 Latchbolt lever | \$3.80 |
| 01-1146 #8-32 x 3/8" Ph. Fl. Screw | \$0.90 | 28-0109 Cam | \$1.26 |
| 01-1182 Socket head cap screw | \$2.39 | *28-0110 End cap (30) | \$17.66 |
| 01-1183 Truss head machine screw | \$0.66 | *28-0111 3828 Series Chassis Cover | \$124.94 |
| 01-1190 Self tapping screw | \$1.68 | *28-0116 3727 Cover | \$124.94 |
| *01-1209 #8-32 x 1/2" Machine Screw | \$2.02 | *28-0119 Top & Bottom - 3727Cover | \$49.02 |
| 01-1484 Machine Screw & Washer (01-0011) | \$0.64 | *28-2011 Rail Assy. Cam Lockdown "E" (24" - 30") | \$333.34 |
| 01-1493 Bar Locking Screw | \$1.74 | *28-2012 Rail Assy. Cam Lockdown "F" (30" - 36") (20) | \$333.34 |
| 01-1494 Bar Locking Screw (90) | \$1.92 | *28-2014 Rail Assy. Cam Lockdown "G" (36" - 48") (20) | \$333.34 |
| *01-2089 #10 x 1" Wood Screw | \$1.66 | *28-2026 Screw Pk | \$7.13 |
| 01-2455 10 x 1-1/4" Ph. Rd. Wood Screw | \$1.66 | 28-2028 2710 Chassis Assy. less cover LHRB | \$215.72 |

*Specify hardware or painted finish required. Consult catalog for available finishes.

ED-58 EXIT DEVICES

SARGENT®

ASSA ABLOY

PARTS

USA & Canada Prices Effective June 3, 2019

| Part No. | Price | Part No. | Price |
|----------|--|----------|-------------------------------------|
| 28-2029 | 2710 Chassis Assy. less cover RHRB | 68-0261 | Thumb Piece Lever RHRB |
| *28-2066 | 12- Rail Assy. E (24" - 30") (20) | 68-0271 | Pivot Pin |
| *28-2067 | 12- Rail Assy. F (30" - 36") (20) | 68-0273 | Bushing |
| *28-2069 | 12- Rail Assy. G (36" - 48") (20) | 68-0311 | Cam (cylc. Lockdown) 16-60 |
| 28-2146 | 12-2828 Chassis Assy. less cover – Old Style | 68-0323 | Chassis Pin |
| 28-2147 | 2800 CTR Case Pack – New Style | 68-0324 | Lift Lever Pivot Pin |
| 28-2148 | 12-2800 CTR Case Pack – New Style | 68-0327 | Main Slide |
| 28-2157 | 2727 Chassis Assy. less cover LHRB – Old Style | 68-0337 | Lift lever LHRB |
| 28-2158 | 2727 Chassis Assy. less cover RHRB – Old Style | 68-0338 | Lift lever RHRB |
| 28-2408 | New 2828/3828 Chas Assy Less Cvr | 68-0367 | Knob Hub Cover |
| 28-2409 | 12- 20/30 Chassis Assy less Cvr – New Style | 68-0368 | Locking slide spring LHRB |
| 28-2427 | New 2737/3727 Chassis Assy less Cvr | *68-0405 | Cover (8700) |
| 28-2428 | New 2727/3727 R Chas Assy Less Cvr | *68-0406 | Cover (12-8888 & 8888) |
| *28-2435 | 3828 Center Case Pack | *68-0407 | Cover (8900) |
| *28-2446 | 30 Ser RI Assy E Cam Lockdown (24" - 30") | *68-0408 | Cover LHRB 8616/66 |
| *28-2447 | 30 Ser RI Assy F Cam Lockdown (30" - 36") | *68-0409 | Cover RHRB 8616/66 |
| *28-2448 | 30 Ser RI Assy G Cam Lockdown (36" - 48") | *68-0410 | Cover LHRB 8916/66 |
| *28-2449 | 30 Ser RI Assy E 16- (28" - 32") | *68-0411 | Cover RHRB 8916/66 |
| *28-2450 | 30 Ser RI Assy F 16- (32" - 36") | 68-0419 | Guide spring |
| *28-2451 | 30 Ser RI Assy G 16- (44" - 48") | 68-0434 | Endcap for 20 Series |
| *28-2452 | 30 Ser RI Assy E 12- (24" - 30") | 68-0456 | latchbolt (12-9800) |
| *28-2453 | 30 Ser RI Assy F 12- (30" - 36") | 68-0477 | Lift lever LHRB |
| *28-2454 | 30 Ser RI Assy G 12- (36" - 48") | 68-0478 | Lift lever RHRB |
| *28-2457 | Top Latch Assy | 68-0482 | Latchbolt (8500) |
| *28-2491 | 3727 Bottom Chassis Assy w/ Cvr | 68-0484 | Endcap for 6300-6500 exits |
| *28-2492 | 12-3727 Bottom Case Assy w/ Cvr | 68-0489 | Lift lever LHRB 1-3/4" door (8300) |
| *28-2493 | 12-3727 Top Case Assy w/ Cvr | 68-0490 | Lift lever RHRB 1-3/4" door (8300) |
| *28-2494 | 3727 Top Case Assy w/ Cvr | 68-0491 | Lift lever LHRB 2-3/4" door (8300) |
| 32-1213 | Bracket for 5100 | 68-0492 | Lift lever RHRB 2-3/4" door (8300) |
| 32-1254 | Machine screw | *68-0495 | Cover (8500) |
| 52-2285 | Mullion Wire Conn. Assy. | *68-0496 | Cover (8300/8400) |
| 52-2558 | 59-80 Circuit Brd asy | 68-0511 | Mounting Plate |
| 52-2997 | 57- F Circuit Board Kit | 68-0536 | Lift lever LHRB (8400) |
| 52-2998 | 57-J Circuit Board Kit | 68-0537 | Lift lever RHRB (8400) |
| 52-2999 | 57- G Circuit Board Kit | *68-0549 | Mounting rail insert "F" – Wide |
| 52-5052 | 59-Circuit Brd Repl. Kit | *68-0550 | Mounting rail insert "E" – Wide |
| 68-0007 | Foam Rod Bushing | *68-0551 | Mounting rail insert "G" – Wide |
| 68-0011 | Main Slide Assy - MD8600 | *68-0552 | Mounting rail insert "G" – Narrow |
| 68-0012 | Roller (Main slide) | *68-0553 | Mounting Rail Insert "J" – Narrow |
| 68-0030 | Rail Shipping plug | *68-0554 | Mounting rail insert "J" – Wide |
| 68-0037 | Bottom Case (8400) | 68-0559 | 700-1 Lever |
| 68-0101 | CENTER LINK LH | 68-0561 | Lexan end cap for 80 series |
| 68-0102 | CENTER LINK RH | *68-0574 | Shim for 8893/8895 |
| *68-0201 | Mtg. Rail 8893E | 68-0582 | Lock down cam |
| *68-0202 | Mtg. Rail 8893F | 68-0583 | Lockdown button (20 & 80) |
| *68-0204 | Mtg. Rail 8893G | *68-0585 | F push rail (16- cylinder lockdown) |
| *68-0229 | Pivot Pin (Push Rail) | *68-0615 | Push rail "E" |
| 68-0233 | Mounting Plate | *68-0616 | Push rail "J" |
| 68-0236 | Connecting Arm Spring | *68-0617 | Push rail "G" |
| 68-0237 | latchbolt Lever LHRB | *68-0618 | Push Rail "F" |
| 68-0238 | latchbolt Lever RHRB | *68-0632 | Mounting rail insert, inactive "F" |
| 68-0239 | Lift Arm Pivot Pin | *68-0633 | Mounting rail insert, inactive "G" |
| 68-0240 | Thumb piece lever (blank) | *68-0635 | Shim (top & bottom case) |
| 68-0241 | Lift Arm | *68-0636 | Shim (mounting plate) glass bead |
| 68-0260 | Thumb Piece Lever LHRB | *68-0637 | Shim (guide case) glass bead |

*Specify hardware or painted finish required. Consult catalog for available finishes.

USA & Canada Prices Effective June 3, 2019

| Part No. | Price | Part No. | Price |
|--|----------|---|----------|
| * 68-0638 Shim (C-case) glass bead kit | \$34.62 | * 68-1042 Mtg. Rail F-narrow | \$302.24 |
| 68-0639 Rod Connector (570 & 571) | \$20.76 | * 68-1043 Mtg. Rail J-narrow | \$302.24 |
| 68-0644 Hooked tool | \$3.88 | * 68-1044 Mtg. Rail G-narrow | \$302.24 |
| 68-0663 Shrink Tube | \$1.31 | * 68-1058 Mtg. Rail F-wide | \$302.24 |
| 68-0674 Wire mesh guard (80 del) | \$4.82 | * 68-1059 Mtg. Rail J-wide | \$302.24 |
| 68-0691 Mounting plate end cap | \$29.09 | * 68-1060 Mtg. Rail G-wide | \$302.24 |
| 68-0729 80 Series Rail Plug | \$1.48 | * 68-1085 Switch latchbolt monitor | \$46.32 |
| * 68-0737 PS Rail (Cam) 12-8J | \$209.23 | * 68-1086 Switch latchbolt monitor | \$46.32 |
| * 68-0738 PS Rail (Cam) 12-8G | \$224.21 | 68-1090 Lift Lever | \$30.77 |
| * 68-0767 Mounting rail insert 16-8F W | \$118.59 | 68-1096 Spring (guard) | \$5.40 |
| * 68-0768 Mounting rail insert 16-8E W | \$118.59 | 68-1137 Lift Lever | \$89.69 |
| * 68-0769 Mounting rail insert 16-8G W | \$118.59 | 68-1155 Latch Retr. LVR | \$9.19 |
| * 68-0770 Mounting rail insert 16-8G N | \$118.59 | 68-1163 Pusher bolt | \$17.78 |
| * 68-0771 Mounting rail insert 16-8J W | \$118.59 | 68-1164 Pusher lever | \$45.42 |
| 68-0772 Cylinder Lockdown Filler | \$7.96 | 68-1166 Activation bolt | \$41.31 |
| * 68-0775 Mtg. Rail E-narrow | \$302.26 | 68-1168 Active case pivot | \$44.30 |
| * 68-0777 Mtg. Rail G-narrow | \$302.26 | 68-1170 Outside acuator (LHRB) | \$47.62 |
| * 68-0778 Mtg. Rail F-narrow | \$302.26 | 68-1171 Outside acuator (RHRB) | \$47.62 |
| * 68-0780 Mtg. Rail E-wide | \$302.26 | 68-1172 Retractor | \$7.39 |
| * 68-0782 Mtg. Rail G-wide | \$302.26 | 68-1174 Pusher slide | \$7.96 |
| * 68-0783 Mtg. Rail F-wide | \$302.26 | 68-1180 Tube support | \$8.89 |
| 68-0814 Bushing | \$0.54 | 68-1182 Center link pin | \$10.00 |
| * 68-0826 Mtg. Rail G-wide/narrow (55-56) | \$415.59 | * 68-1183 Inactive OS Front (32D only) | \$88.00 |
| * 68-0828 Mtg. Rail J-wide/narrow (55-56) | \$415.59 | 68-1184 Guide pin | \$7.96 |
| * 68-0836 Mtg. Rail Insert F-wide | \$81.52 | 68-1186 Active Outside Front | \$22.06 |
| * 68-0838 Mtg. Rail Insert G-wide | \$81.52 | 68-1191 Link Pin | \$8.72 |
| * 68-0839 Mtg. Rail Insert J-wide/G-narrow | \$81.52 | 68-1193 Upper link spring | \$10.00 |
| * 68-0840 Mtg. Rail Insert J-narrow | \$81.52 | 68-1201 Plug | \$3.32 |
| 68-0852 700-4 Cam | \$29.09 | 68-1208 ET cam (LH) | \$15.20 |
| 68-0853 Bracket | \$9.19 | 68-1209 ET cam (RH) | \$15.20 |
| * 68-0866 Mtg. Rail - 8895E | \$352.60 | 68-1210 Hairpin | \$1.12 |
| * 68-0868 Mtg. Rail - 8895G | \$352.60 | 68-1217 Roll pin | \$0.97 |
| 68-0888 Bottom Plate | \$12.54 | 68-1220 Active bolt guide | \$7.76 |
| 68-0890 Mounting bracket (RHRB) WD-12-8600 | \$34.62 | 68-1222 Inactive bolt guide | \$5.94 |
| 68-0891 Mounting bracket (LHRB) WD-12-8600 | \$34.62 | 68-1224 Center link (LH) | \$46.32 |
| 68-0917 Auxiliary Control Plate | \$4.65 | 68-1225 Center link (RH) | \$46.32 |
| 68-0918 Extension Rod | \$24.26 | 68-1245 Adjustment Tube | \$4.44 |
| 68-0933 Mount plate (WD-12-8600) | \$32.24 | 68-1254 Extension Bracket (700-6) | \$10.94 |
| 68-0943 Bracket | \$7.63 | 68-1255 Cover Plate – PP/PR/SP8600 | \$9.80 |
| 68-0945 Pivot pin (new style) | \$10.20 | 68-1256 Adjustment Tube Pin | \$6.49 |
| * 68-0948 Mounting Rail J-Wide | \$264.24 | 68-1270 Ext. Connector | \$27.79 |
| * 68-0949 Mounting Rail G-Wide | \$264.24 | * 68-1317 Pull Lever Cover – LP/LR/LS8600 | \$163.09 |
| * 68-0950 Mounting Rail E-Wide | \$264.24 | * 68-1319 Mtg. Rail - L | \$352.60 |
| * 68-0952 Mounting Rail F-Wide | \$264.24 | * 68-1320 Mtg. Rail - M | \$352.60 |
| * 68-0955 Mounting Rail F-Narrow | \$264.24 | * 68-1321 Mtg. Rail - N | \$352.60 |
| * 68-0956 Mounting Rail J-Narrow | \$264.24 | * 68-1324 Mtg. Rail Insert - L | \$81.52 |
| * 68-0957 Mounting Rail G-Narrow | \$264.24 | * 68-1325 Mtg. Rail Insert - M | \$81.52 |
| * 68-0958 Mounting Rail E-Narrow | \$264.24 | * 68-1326 Mtg. Rail Insert - N | \$81.52 |
| * 68-1014 59-8800 Cover (Wide) | \$242.17 | 68-1363 Center Spring | \$6.83 |
| * 68-1015 59-8816 & 66 LH Cover (Wide) | \$265.00 | 68-1366 Latchbolt Lift Lever | \$2.58 |
| * 68-1016 59-8816 & 66 RH Cover (Wide) | \$265.00 | 68-1367 Latchbolt Lift Lever | \$2.58 |
| * 68-1020 59-8800 Cover - Narrow | \$292.78 | * 68-1369 Mtg. Rail F-wide/narrow (55-56) | \$415.59 |
| * 68-1028 Push Rail 59-80J | \$289.66 | * 68-1373 Mtg. Rail Insert F-narrow | \$81.89 |
| * 68-1029 Push Rail 59-80G | \$314.81 | * 68-1375 Mtg. Rail Insert E/F-Narrow | \$81.52 |
| * 68-1030 Push Rail 59-80F | \$277.05 | * 68-1376 Mtg. Rail Insert E/F-Narrow (16-) | \$118.59 |

*Specify hardware or painted finish required. Consult catalog for available finishes.

ED-60 EXIT DEVICES

SARGENT®

PARTS

ASSA ABLOY

USA & Canada Prices Effective June 3, 2019

| Part No. | Price | Part No. | Price |
|--|------------|---|------------|
| * 68-1410 Mtg. Rail L (55-56) | \$415.59 | * 68-2291 12-8900 Pack all functions LHRB | \$874.04 |
| * 68-1411 Mtg. Rail M (55-56) | \$415.59 | * 68-2292 12-8900 Pack all functions RHRB | \$874.04 |
| * 68-1412 Mtg. Rail N (55-56) | \$415.59 | * 68-2298 8900 all functions - LHRB Chassis Pack | \$876.64 |
| * 68-1414 Mtg. Rail - L | \$302.24 | * 68-2299 8900 all functions - RHRB Chassis Pack | \$876.64 |
| * 68-1415 Mtg. Rail - M | \$302.24 | * 68-2305 8828 Chassis Pack LHRB | \$1,106.59 |
| * 68-1416 Mtg. Rail - N | \$302.24 | * 68-2306 8828 Chassis Pack RHRB | \$1,106.59 |
| * 68-1444 Push Rail E (8895) | \$277.05 | * 68-2307 8863 Chassis Pack LHRB | \$1,145.32 |
| * 68-1445 Push Rail F/J (8895) | \$289.66 | * 68-2308 8863 Chassis Pack RHRB | \$1,145.32 |
| * 68-1446 Push Rail G (8895) | \$327.40 | * 68-2313 8816 Chassis Pack LHRB | \$1,433.46 |
| 68-1455 Top Rod Adjuster | \$5.56 | * 68-2314 8816 Chassis Pack RHRB | \$1,433.46 |
| * 68-1466 Mtg. Rail J-narrow | \$302.24 | * 68-2315 8866 Chassis Assy. LHRB | \$1,433.46 |
| * 68-1467 Mtg. Rail J-wide | \$302.24 | * 68-2316 8866 Chassis Assy. RHRB | \$1,433.46 |
| * 68-1468 Mtg. Rail - 8895J | \$352.60 | 68-2326 12-8863 Chassis Assy. less cover LHRB | \$1,196.28 |
| * 68-1469 Mtg. Rail - 8895F | \$352.60 | 68-2327 12-8863 Chassis Assy. less cover RHRB | \$1,196.28 |
| * 68-1477 Mtg. Rail Insert J/G (8895) | \$81.52 | 68-2329 12-8828 Chassis Assy. less cover LHRB | \$1,157.55 |
| * 68-1479 Mtg. Rail Insert -L | \$81.52 | 68-2330 12-8828 Chassis Assy. less cover RHRB | \$1,157.55 |
| * 68-1480 Mtg. Rail Insert - M | \$81.52 | * 68-2333 12-8828 Chassis Pack LHRB | \$1,361.01 |
| * 68-1481 Mtg. Rail Insert - N | \$81.52 | * 68-2334 12-8828 Chassis Pack RHRB | \$1,361.01 |
| 68-1503 LIFT LEVER (8600) | \$15.80 | * 68-2335 12-8863 Chassis Pack LHRB | \$1,361.01 |
| 68-1644 LIFT LEVER LH | \$54.24 | * 68-2336 12-8863 Chassis Pack. RHRB | \$1,361.01 |
| 68-1645 LIFT LEVER RH | \$54.24 | * 68-2341 12-8816 Chassis Pack LHRB | \$1,640.07 |
| 68-1657 Interlocking Shim for FM8700 | \$30.70 | * 68-2342 12-8816 Chassis Pack RHRB | \$1,640.07 |
| 68-1662 Rail shim | \$53.60 | * 68-2343 12-8866 Chassis Pack LHRB | \$1,525.38 |
| 68-2106 8828 Chassis Assy. less cover LHRB | \$954.14 | * 68-2344 12-8866 Chassis Pack RHRB | \$1,525.38 |
| 68-2107 8828 Chassis Assy. less cover RHRB | \$954.14 | 68-2352 8816 Chassis Assy. less cover LHRB | \$1,271.34 |
| 68-2109 8863 Chassis Assy. less cover LHRB | \$718.14 | 68-2353 8816 Chassis Assy. less cover RHRB | \$1,271.34 |
| 68-2110 8863 Chassis Assy. less cover RHRB | \$718.14 | 68-2409 12-8815 Chassis Assy. less cover LHRB – Old | \$1,008.20 |
| * 68-2113 Screw Pk | \$18.37 | 68-2410 12-8815 Chassis Assy. less cover RHRB – Old | \$1,008.20 |
| 68-2116 Chassis Asy HC 8800 | \$380.78 | 68-2425 12-8816 Chassis Assy. less cover LHRB | \$1,486.64 |
| 68-2117 Chassis Asy 12-HC 8800 | \$468.08 | 68-2426 12-8816 Chassis Assy. less cover RHRB | \$1,486.64 |
| * 68-2143 Screw Pk A | \$42.76 | 68-2443 12-8866 Chassis Assy. less cover LHRB | \$1,314.33 |
| 68-2163 8710 Chassis Assy. less cover LHRB | \$819.04 | 68-2444 12-8866 Chassis Assy. less cover RHRB | \$1,314.33 |
| 68-2164 8710 Chassis Assy. less cover RHRB | \$819.04 | * 68-2446 8706/8713 Chassis Pack LHRB | \$1,386.77 |
| 68-2172 8900 All functions less cover LHRB | \$526.04 | * 68-2447 8706/8713 Chassis Pack RHRB | \$1,386.77 |
| 68-2173 8900 All functions less cover RHRB | \$526.04 | * 68-2448 8715 Chassis Pack LHRB | \$1,254.86 |
| 68-2198 Locking slide LHRB (8700) | \$17.05 | * 68-2449 8715 Chassis Pack RHRB | \$1,254.86 |
| 68-2199 Locking slide RHRB (8700) | \$17.05 | * 68-2450 8728 Chassis Pack LHRB | \$1,249.49 |
| 68-2201 8706/8713 Chassis Assy. less cov. LHRB | \$1,105.11 | * 68-2451 8728 Chassis Pack RHRB | \$1,249.49 |
| 68-2202 8706/8713 Chassis Assy. less cov. RHRB | \$1,105.11 | * 68-2452 8762/8763 Chassis Pack LHRB | \$1,351.19 |
| 68-2204 8762/8763 Chassis Assy. less cov. LHRB | \$1,120.51 | * 68-2453 8762/8763 Chassis Pack RHRB | \$1,351.19 |
| 68-2205 8762/8763 Chassis Assy. less cov. RHRB | \$1,120.51 | * 68-2454 12-8706/12-8713 Chassis Pack LHRB | \$1,518.91 |
| 68-2207 8715 Chassis Assy. less cover LHRB | \$1,034.71 | * 68-2455 12-8706/12-8713 Chassis Pack RHRB | \$1,518.91 |
| 68-2208 8715 Chassis Assy. less cover RHRB | \$1,034.71 | * 68-2456 12-8715 Chassis Pack LHRB | \$1,515.91 |
| 68-2210 8728 Chassis Assy. less cover LHRB | \$1,019.13 | * 68-2457 12-8715 Chassis Pack RHRB | \$1,515.91 |
| 68-2211 8728 Chassis Assy. less cover RHRB | \$1,019.13 | * 68-2458 12-8728 Chassis Pack LHRB | \$1,452.91 |
| 68-2213 8916/8966 Chassis Assy. less cov. LHRB | \$669.08 | * 68-2459 12-8728 Chassis Pack RHRB | \$1,452.91 |
| 68-2214 8916/8966 Chassis Assy. less cov. RHRB | \$669.08 | * 68-2460 12-8762/12-8763 Chassis Pack LHRB | \$1,554.65 |
| 68-2216 8866 Chassis Assy. LHRB (Less Cover) | \$1,010.45 | * 68-2461 12-8762/12-8763 Chassis Pack RHRB | \$1,554.65 |
| 68-2217 8866 Chassis Assy. RHRB (Less Cover) | \$1,010.45 | * 68-2463 8916/8966 Chassis Pack LHRB | \$915.37 |
| * 68-2262 12-8710 Chassis Pack LHRB | \$1,302.66 | * 68-2464 8916/8966 Chassis Pack RHRB | \$915.37 |
| * 68-2263 12-8710 Chassis Pack RHRB | \$1,302.66 | * 68-2466 12-8916/12-8966 Chassis Pack LHRB | \$953.17 |
| * 68-2268 8710 Chassis Pack LHRB | \$1,034.71 | * 68-2467 12-8916/12-8966 Chassis Pack RHRB | \$953.17 |
| * 68-2269 8710 Chassis Pack RHRB | \$1,034.71 | 68-2481 8300 Chassis Assy. less cover LHRB | \$724.15 |
| * 68-2274 Standard screw pack 12-8700 | \$30.77 | 68-2482 8300 Chassis Assy. less cover RHRB | \$724.15 |

*Specify hardware or painted finish required. Consult catalog for available finishes.

USA & Canada Prices Effective June 3, 2019

| Part No. | Price | Part No. | Price | | |
|-----------|--|------------|-----------|---|------------|
| * 68-2486 | 8300 all functions Chassis Pack LHRB | \$972.99 | * 68-2807 | 16-55 Rail Assy. G- Narrow | \$1,518.91 |
| * 68-2487 | 8300 all functions Chassis Pack RHRB | \$972.99 | * 68-2808 | 16-55 Rail Assy. J- Narrow | \$1,518.91 |
| * 68-2524 | 12-8300 Chassis Pack LHRB | \$1,067.68 | * 68-2809 | 12-55 Rail Assy. E- Narrow | \$1,364.91 |
| * 68-2525 | 12-8300 Chassis Pack RHRB | \$1,067.68 | * 68-2810 | 12-55 Rail Assy. F- Narrow | \$1,364.91 |
| 68-2594 | 8600 Chassis Assy. less cover LHRB – Old | \$501.31 | * 68-2811 | 12-55 Rail Assy. G- Narrow | \$1,364.91 |
| 68-2595 | 8600 Chassis Assy. less cover RHRB – Old | \$501.31 | * 68-2812 | 12-55 Rail Assy J- Narrow | \$1,364.91 |
| 68-2596 | Dogging kit | \$26.48 | * 68-2815 | Cam 57-86/87/88/89 Rail Assy. F- Wide (36") | \$1,893.18 |
| 68-2597 | Bridge rectifier pack | \$26.48 | * 68-2817 | Cam 57-86/87/88/89 Rail Assy. G- Wide | \$1,893.18 |
| * 68-2694 | Rail Assy. wide cam lockdown "E" (24" - 32") | \$1,001.56 | * 68-2818 | Cam 57-86/87/88/89 Rail Assy. J- Wide | \$1,893.18 |
| * 68-2695 | Rail Assy. wide cam lockdown "F" (33" - 36") | \$1,001.56 | * 68-2823 | 12-57-86/87/88/89 Rail Assy. F- Wide (36") | \$1,871.14 |
| * 68-2696 | Rail Assy. wide cam lockdown "G" (43" - 48") | \$1,001.56 | * 68-2825 | 12-57-86/87/88/89 Rail Assy. G- Wide | \$1,871.14 |
| * 68-2697 | Rail Assy. Wide cam lockdown "J"(37" - 42") | \$1,001.56 | * 68-2826 | 12-57-86/87/88/89 Rail Assy. J- Wide | \$1,871.14 |
| * 68-2698 | 16-Rail Assy. wide "E" (28" - 32") | \$1,144.79 | * 68-2827 | 57-83/84/85 Rail Assy. E- Narrow (32") | \$1,893.18 |
| * 68-2699 | 16- Rail Assy. wide "F" (33" - 36") | \$1,144.79 | * 68-2828 | 57-84/85 Rail Assy. F- Narrow | \$1,893.18 |
| * 68-2700 | 16- Rail Assy. wide "G" (43" - 48") | \$1,144.79 | * 68-2829 | 57-83/84/85 Rail Assy. G- Narrow | \$1,893.18 |
| * 68-2701 | 16- Rail Assy. Wide "J" (37" - 42") | \$1,144.79 | * 68-2830 | 57-83/84/85 Rail Assy. J- Narrow | \$1,893.18 |
| * 68-2702 | 12-Rail Assy. wide "E" (24" - 32") | \$1,001.56 | * 68-2835 | 12-57 83/84/85 Rail Assy E Narrow | \$1,871.14 |
| * 68-2703 | 12- Rail Assy. "F" (33" - 36") | \$1,001.56 | * 68-2836 | 12-57 83/84/85 Rail Assy F Narrow | \$1,871.14 |
| * 68-2704 | 12- Rail Assy. "G" (43" - 48") | \$1,001.56 | * 68-2837 | 12-57-83/84/85 Rail Assy. G- Narrow | \$1,871.14 |
| * 68-2705 | 12- Rail Assy. "J" (37" - 42") | \$1,001.56 | * 68-2838 | 12-57-83/84/85 Rail Assy. J- Narrow | \$1,871.14 |
| * 68-2706 | Dummy Rail Assy. "E" | \$488.81 | * 68-2905 | 19-Rail Assy. "E" Narrow (24" - 32") | \$975.77 |
| * 68-2707 | Dummy Rail Assy. "F" | \$488.81 | * 68-2906 | 19- Rail Assy. "F" Narrow (33" - 36") | \$975.77 |
| * 68-2708 | Dummy Rail Assy. "G" | \$488.81 | * 68-2907 | 19- Rail Assy. "G" Narrow (43" - 48") | \$975.77 |
| * 68-2716 | Rail Assy. narrow cam lockdown "E" | \$1,001.56 | * 68-2908 | 19- Rail Assy. "J" Narrow (37" - 42") | \$975.77 |
| * 68-2717 | Rail Assy. narrow cam lockdown "F" | \$1,001.56 | * 68-2909 | 16-19- Rail Assy. "E" Narrow (26" - 32") | \$1,122.72 |
| * 68-2718 | Rail Assy. narrow cam lockdown "G" | \$1,001.56 | * 68-2910 | 16-19- Rail Assy. "F" Narrow (33" - 36") | \$1,122.72 |
| * 68-2719 | Rail Assy. Narrow cam lockdown "J" | \$1,001.56 | * 68-2911 | 16-19- Rail Assy. "G" Narrow (43" - 48") | \$1,122.72 |
| * 68-2720 | 16-Rail Assy. narrow "E" (26" - 32") | \$1,144.79 | * 68-2912 | 16-19- Rail Assy. "J" Narrow (37" - 42") | \$1,122.72 |
| * 68-2721 | 16- Rail Assy. narrow "F" (33" - 36") | \$1,144.79 | * 68-2913 | 12-19- Rail Assy. "E" Narrow (24" - 32") | \$975.05 |
| * 68-2722 | 16- Rail Assy. narrow "G" (43" - 48") | \$1,144.79 | * 68-2914 | 12-19- Rail Assy. "F" Narrow (33" - 36") | \$975.05 |
| * 68-2723 | 16- Rail Assy "J" Narrow (37" - 42") | \$1,144.79 | * 68-2915 | 12-19- Rail Assy. "G" Narrow (43" - 48") | \$975.05 |
| * 68-2724 | 12-Rail Assy. narrow "E" (24" - 32") | \$1,001.56 | * 68-2916 | 12-19- Rail Assy. "J" Narrow (37" - 42") | \$975.05 |
| * 68-2725 | 12- Rail Assy. "F" narrow (33" - 36") | \$1,001.56 | * 68-2918 | 19- Rail Assy. "E" Wide (24" - 32") | \$975.05 |
| * 68-2726 | 12- Rail Assy. "G" narrow (43" - 48") | \$1,001.56 | * 68-2919 | 19- Rail Assy. "F" Wide (33" - 36") | \$975.05 |
| * 68-2727 | 12- Rail Assy. "J" narrow (37" - 42") | \$1,001.56 | * 68-2920 | 19- Rail Assy. "G" Wide (43" - 48") | \$975.05 |
| * 68-2757 | Mtg. Rail Insert - E-55-8895 | \$81.52 | * 68-2921 | 19- Rail Assy. "J" Wide (37" - 42") | \$975.05 |
| * 68-2789 | 55-86/87/88/89 Rail Assy. E- Wide | \$1,386.77 | * 68-2922 | 16-19- Rail Assy. "E" Wide (28" - 32") | \$1,122.72 |
| * 68-2790 | 55-86/87/88/89 Rail Assy. F- Wide | \$1,386.77 | * 68-2923 | 16-19- Rail Assy. "F" Wide (33" - 36") | \$1,122.72 |
| * 68-2791 | 55-86/87/88/89 Rail Assy. G- Wide | \$1,386.77 | * 68-2924 | 16-19- Rail Assy. "G" Wide (43" - 48") | \$1,122.72 |
| * 68-2792 | 55-86/87/88/89 Rail Assy J-wide | \$1,386.77 | * 68-2925 | 16-19- Rail Assy. "J" Wide (37" - 42") | \$1,122.72 |
| * 68-2793 | 16-55-86/87/88/89 Rail Assy. E-wide | \$1,519.44 | * 68-2926 | 12-19- Rail Assy. "E" Wide (24" - 32") | \$977.39 |
| * 68-2794 | 16-55-86/87/88/89 Rail Assy. F- Wide | \$1,519.44 | * 68-2927 | 12-19- Rail Assy. "F" Wide (33" - 36") | \$977.39 |
| * 68-2795 | 16-55-86/87/88/89 Rail Assy. G- Wide | \$1,519.44 | * 68-2928 | 12-19- Rail Assy. "G" Wide (43" - 48") | \$977.39 |
| * 68-2796 | 16-55-86/87/88/89 Rail Assy. J-wide | \$1,519.44 | * 68-2929 | 12-19- Rail Assy. "J" Wide (37" - 42") | \$977.39 |
| * 68-2797 | 12-55-86/87/88/89 Rail Assy. E- Wide | \$1,364.91 | * 68-2941 | 55-12-19-8G Rail Assy - Wide | \$1,287.63 |
| * 68-2798 | 12-55-86/87/88/89 Rail Assy. F- Wide | \$1,364.91 | * 68-2942 | 55-12-19-8J Rail Assy - Wide | \$1,287.63 |
| * 68-2799 | 12-55-86/87/88/89 Rail Assy. G- Wide | \$1,364.91 | * 68-2943 | 55-19-8E Rail Assy - Narrow | \$1,386.77 |
| * 68-2800 | 12-55-86/87/88/89 Rail Assy. J-Wide | \$1,364.91 | * 68-2944 | 55-19-8F Rail Assy - Narrow | \$1,386.77 |
| * 68-2801 | 55-83/84/85 Rail Assy. E- Narrow | \$1,386.77 | * 68-2977 | Rail Assy Cam Lockdown 8E | \$1,893.18 |
| * 68-2802 | 55-83/84/85 Rail Assy. F- Narrow | \$1,386.77 | * 68-2978 | Rail Assy Cam Lockdown 8F | \$1,893.18 |
| * 68-2803 | 55-83/84/85 Rail Assy. G- Narrow | \$1,386.77 | * 68-2979 | Rail Assy Cam Lockdown 8G | \$1,893.18 |
| * 68-2804 | 55- 83/84-85 Rail Assy. J- Narrow | \$1,386.77 | * 68-2980 | Rail Assy Cam Lockdown 8J | \$1,893.18 |
| * 68-2805 | 16-55 Rail Assy. E- Narrow | \$1,518.91 | * 68-2977 | 19-57 Rail Assy E Narrow | \$1,893.18 |
| * 68-2806 | 16-55 Rail Assy. F- Narrow | \$1,518.91 | * 68-2978 | 19-57 Rail Assy F Narrow | \$1,893.18 |

*Specify hardware or painted finish required. Consult catalog for available finishes.

ED-62 EXIT DEVICES

SARGENT®

PARTS

ASSA ABLOY

USA & Canada Prices Effective June 3, 2019

| Part No. | Price | Part No. | Price | | |
|-----------|--------------------------------------|------------|-----------|---|------------|
| * 68-2979 | 19-57 Rail Assy G Narrow | \$1,893.18 | * 68-3094 | 8E Rail Assy (FIRE EX) Wide | \$1,703.84 |
| * 68-2980 | 19-57 Rail Assy J Narrow | \$1,893.18 | * 68-3095 | 8F Rail Assy (FIRE EX) Wide | \$1,703.84 |
| * 68-3023 | Screw Pack for 12-8700 | \$109.31 | * 68-3096 | 8G Rail Assy (FIRE EX) Wide | \$1,703.84 |
| 68-3026 | Screw Pack for wood door 12-8700 | \$61.19 | * 68-3097 | 8J Rail Assy (FIRE EX) Wide | \$1,703.84 |
| 68-3033 | Switch and plate assy (55-80) | \$218.28 | * 68-3098 | 8E Narrow Rail Assy (Cam Dog) | \$1,518.91 |
| * 68-3036 | 58-86/87/88/89 Rail Assy. E | \$1,518.91 | * 68-3099 | 8F Narrow Rail Assy (Cam Dog) | \$1,518.91 |
| * 68-3037 | 58-86/87/88/89 Rail Assy. F | \$1,518.91 | * 68-3100 | 8G Narrow Rail Assy (Cam Dog) | \$1,518.91 |
| * 68-3038 | 58-86/87/88/89 Rail Assy. G | \$1,518.91 | * 68-3101 | 8J Narrow Rail Assy (Cam Dog) | \$1,518.91 |
| * 68-3039 | 58-86/87/88/89 Rail Assy J | \$1,518.91 | * 68-3149 | Center case pack (LHRB) 10 & 40 function | \$926.52 |
| * 68-3040 | 16-58-86/87/88/89 Rail Assy E-Wide | \$1,651.00 | * 68-3150 | Center case pack (RHRB) 10 & 40 function | \$926.52 |
| * 68-3041 | 16-58-86/87/88/89 Rail Assy. F- Wide | \$1,651.00 | * 68-3153 | Center case pack (LHRB) 28 function | \$926.52 |
| * 68-3042 | 16-58-86/87/88/89 Rail Assy. G- Wide | \$1,651.00 | * 68-3154 | Center case pack (RHRB) 28 function | \$926.52 |
| * 68-3043 | 16-58-86/87/88/89 Rail Assy J-Wide | \$1,651.00 | * 68-3211 | 56-86/87/88/89 Rail Assy. G- Wide | \$2,091.28 |
| * 68-3044 | 12-58-86/87/88/89 Rail Assy. E- Wide | \$1,496.82 | * 68-3212 | 56-86/87/88/89 Rail Assy. F- Wide | \$2,091.28 |
| * 68-3045 | 12-58-86/87/88/89 Rail Assy. F- Wide | \$1,496.82 | * 68-3213 | 56-86/87/88/89 Rail Assy. J- Wide | \$2,091.28 |
| * 68-3046 | 12-58-86/87/88/89 Rail Assy. G- Wide | \$1,496.82 | * 68-3216 | 56-83/84/85 Rail Assy. G- Narrow | \$2,091.28 |
| * 68-3047 | 12-58-86/87/88/89 Rail Assy J-Wide | \$1,496.82 | * 68-3217 | 56-83/84/85 Rail Assy. F- Narrow | \$2,091.28 |
| * 68-3048 | 58-83/84/85 Rail Assy. E- Narrow | \$1,518.91 | * 68-3218 | 56-83/84/85 Rail Assy. J- Narrow | \$2,091.28 |
| * 68-3049 | 58-83/84/85 Rail Assy. F- Narrow | \$1,518.91 | * 68-3224 | 19-56- 8G Wide Rail | \$2,091.28 |
| * 68-3050 | 58-83/84/85 Rail Assy. G- Narrow | \$1,518.91 | * 68-3225 | 19-56- 8F Wide Rail | \$2,091.28 |
| * 68-3051 | 58- 83/84/85 Rail Assy J- Narrow | \$1,518.91 | * 68-3226 | 19-56- 8J Wide Rail | \$2,091.28 |
| * 68-3052 | 16-58 83-84-85 Rail Assy E- Narrow | \$1,651.00 | * 68-3229 | 19-56-8G Narrow Rail | \$2,091.28 |
| * 68-3053 | 16-58-83/84/85 Rail Assy. F- Narrow | \$1,651.00 | * 68-3230 | 19-56-8F Narrow Rail | \$2,091.28 |
| * 68-3054 | 16-58-83/84/85 Rail Assy. G- Narrow | \$1,651.00 | * 68-3231 | 19-56-8J Narrow Rail | \$2,091.28 |
| * 68-3055 | 16-58 83-84-85 Rail Assy J- Narrow | \$1,651.00 | 68-3233 | MTG PLTE PACK 12-43-56-80 | \$69.13 |
| * 68-3056 | 12-58-83/84/85 Rail Assy. E- Narrow | \$1,496.82 | * 68-3277 | Active Dummy Rail "E" | \$484.40 |
| * 68-3057 | 12-58-83/84/85 Rail Assy. F- Narrow | \$1,496.82 | * 68-3278 | Active Dummy Rail "F" | \$484.40 |
| * 68-3058 | 12-58-83/84/85 Rail Assy. G- Narrow | \$1,496.82 | * 68-3279 | Active Dummy Rail "G" | \$484.40 |
| * 68-3059 | 12-58-83/84/85 Rail Assy. J- Narrow | \$1,496.82 | * 68-3281 | 55-Active Dummy Rail E | \$773.59 |
| * 68-3061 | 55-58 Rail Assy E-Wide | \$2,227.19 | * 68-3282 | 55-Active Dummy Rail F | \$773.59 |
| * 68-3062 | 55-58 Rail Assy F-Wide | \$2,227.19 | * 68-3283 | 55-Active Dummy Rail G | \$773.59 |
| * 68-3063 | 55-58 Rail Assy G-Wide | \$2,227.19 | 68-3292 | Connect Arm assy (55-56-80) | \$46.32 |
| * 68-3064 | 55-58 Rail Assy J-Wide | \$2,227.19 | * 68-3298 | 55-56-86/87/88/89 Rail Assy. G- Wide | \$2,311.38 |
| * 68-3065 | 16-55-58 Rail Assy E-Wide | \$2,299.15 | * 68-3299 | 55-56-86/87/88/89 Rail Assy. F- Wide | \$2,311.38 |
| * 68-3066 | 16-55-58 Rail Assy F-Wide | \$2,299.15 | * 68-3300 | 55-56-86/87/88/89 Rail Assy. J- Wide | \$2,311.38 |
| * 68-3067 | 16-55-58 Rail Assy G-Wide | \$2,299.15 | * 68-3303 | 55-56-83/84/85 Rail Assy. G- Narrow | \$2,311.38 |
| * 68-3068 | 16-55-58 Rail Assy J-Wide | \$2,299.15 | * 68-3304 | 55-56-83/84/85 Rail Assy. F- Narrow | \$2,311.38 |
| * 68-3069 | 12-55-58 Rail Assy E-Wide | \$2,227.19 | * 68-3305 | 55-56-83/84/85 Rail Assy. J- Narrow | \$2,311.38 |
| * 68-3070 | 12-55-58 Rail Assy F-Wide | \$2,227.19 | * 68-3309 | 19-55-56-80 Rail -G Wide | \$2,311.38 |
| * 68-3071 | 12-55-58 Rail Assy G-Wide | \$2,227.19 | * 68-3310 | 19-55-56-80 Rail -F Wide | \$2,311.38 |
| * 68-3072 | 12-55-58 Rail Assy J-Wide | \$2,227.19 | * 68-3311 | 19-55-56-80 Rail -J Wide | \$2,311.38 |
| * 68-3073 | 55-58 Rail Assy E-narrow | \$2,227.19 | * 68-3314 | 19-55-56-80 Rail -G Narrow | \$2,311.38 |
| * 68-3074 | 55-58 Rail Assy F-narrow | \$2,227.19 | * 68-3315 | 19-55-56-80 Rail -F Narrow | \$2,311.38 |
| * 68-3075 | 55-58 Rail Assy G-narrow | \$2,227.19 | * 68-3316 | 19-55-56-80 Rail -J Narrow | \$2,311.38 |
| * 68-3076 | 55-58 Rail Assy J-narrow | \$2,227.19 | 68-3514 | WD-12-8600 Inner case package K | \$181.97 |
| * 68-3077 | 16-55-58 Rail Assy E-narrow | \$2,299.15 | 68-3522 | WD CVR Top Case/Bracket assy 1 3/4" door | \$312.03 |
| * 68-3078 | 16-55-58 Rail Assy F-narrow | \$2,299.15 | 68-3523 | WD CVR Top Case/Bracket assy 1 3/4" Door 1/4" cladding | \$312.03 |
| * 68-3079 | 16-55-58 Rail Assy G-narrow | \$2,299.15 | 68-3524 | WD CVR Top Case/Bracket assy 1 3/4" door 1/2" cladding | \$312.03 |
| * 68-3080 | 16-55-58 Rail Assy J-narrow | \$2,299.15 | 68-3563 | Top & Bottom Case Pk. | \$375.51 |
| * 68-3081 | 12-55-58 Rail Assy E-narrow | \$2,227.19 | 68-3577 | Screw pack | \$16.52 |
| * 68-3082 | 12-55-58 Rail Assy F-narrow | \$2,227.19 | 68-3580 | Inner chassis assy. 700-4 ET and Control | \$255.58 |
| * 68-3083 | 12-55-58 Rail Assy G-narrow | \$2,227.19 | | | |
| * 68-3084 | 12-55-58 Rail Assy J-narrow | \$2,227.19 | | | |

*Specify hardware or painted finish required. Consult catalog for available finishes.

USA & Canada Prices Effective June 3, 2019

| Part No. | Price | Part No. | Price | | |
|-----------|---------------------------------------|------------|-----------|-------------------------------------|------------|
| 68-3627 | Inner case assy. ET & 100 Aux Control | \$358.75 | 68-3827 | 12-59 & 59-8762/63 Chas Assy R | \$1,536.51 |
| 68-3671 | Locking Clip - Adapter Assy | \$28.20 | 68-3829 | 12-59 & 59-8728 Chas Assy L | \$1,435.32 |
| * 68-3674 | MD-12-8400 CC PK LHRB | \$926.48 | 68-3830 | 12-59 & 59-8728 Chas Assy R | \$1,435.32 |
| * 68-3675 | MD-12-8400 CC PK RHRB | \$926.48 | 68-3833 | 59-28 LHRB Chassis Assy | \$1,366.98 |
| * 68-3676 | SCREW PACK (MD-12-8400) | \$10.16 | 68-3834 | 59-28 RHRB Chassis Assy | \$1,366.98 |
| 68-3677 | SCREW PACK (MD-12-8600) | \$16.52 | 68-3835 | 12-59-28 LH Chassis Assy | \$1,529.00 |
| * 68-3678 | MD-12-8600 Chassis pack | \$742.30 | 68-3836 | 12-59-28 RH Chassis Assy | \$1,529.00 |
| 68-3714 | Chassis Assy. 12-59-8706 LHR | \$1,133.28 | 68-3842 | 12-59-80 Screw Pack | \$13.55 |
| 68-3715 | Chassis Assy. 12-59-8706 RHR | \$1,133.28 | * 68-3844 | 12-59-8706/13 CC PK LH | \$1,505.02 |
| 68-3717 | Chassis Assy. 12-59 & 59 8715 LH | \$1,435.32 | * 68-3846 | 12-59&59-8715,73&74 CC LH | \$1,675.85 |
| 68-3718 | Chassis Assy. 12-59 & 59 8715 RH | \$1,435.32 | * 68-3847 | 12-59&59-8715,73&74 CC RH | \$1,675.85 |
| * 68-3751 | 59-8804 CC Pk L | \$1,618.01 | * 68-3850 | 12-59-8762/63 CC PK LH | \$1,505.02 |
| * 68-3757 | 59-8816 CC PK LH | \$1,618.02 | * 68-3851 | 12-59&59-8762/63 CC PK RH | \$1,505.02 |
| * 68-3758 | 59-8816 CC PK RH | \$1,618.02 | * 68-3852 | 12-59&59-8710 CC PK LH | \$1,505.02 |
| * 68-3759 | C/C PACK LH (59-63) | \$1,618.02 | * 68-3853 | 12-59&59-8710 CC PK RH | \$1,505.02 |
| * 68-3760 | 59-8863 CC pk (RH) | \$1,618.02 | 68-3854 | MD-59-8600 Inner Case | \$352.24 |
| * 68-3761 | 59-8866 CC PK (LH) | \$1,618.02 | 68-3855 | MD-12-59-8600 Inner case | \$439.22 |
| * 68-3762 | 59-8866 CC PK (RH) | \$1,618.02 | 68-3859 | WD-59-8600 Inner case PKR | \$332.13 |
| * 68-3765 | 12-59-8804,10,13,15,40,43 | \$1,668.65 | * 68-3873 | 59-8400 C-CASE PK - LH | \$1,618.02 |
| * 68-3771 | 12-59-8816 CC PK LH | \$1,668.65 | * 68-3874 | 59-8400 C-CASE PK - RH | \$1,618.02 |
| * 68-3772 | 12-59-8816 CC PK RH | \$1,668.65 | * 68-3876 | Mfg. Rail Insert G- Wide | \$118.59 |
| * 68-3773 | 12-59-8863 CC PK LH | \$1,668.65 | * 68-3877 | Mtg. Rail Insert - G-narrow | \$118.59 |
| * 68-3774 | 12-59-8863 CC PK RH | \$1,668.65 | * 68-3878 | Mtg. Rail Insert - J-narrow | \$118.59 |
| * 68-3775 | 12-59-8866 CC PK LH | \$1,668.65 | * 68-3879 | Mtg. Rail Insert - 8J narrow | \$118.59 |
| * 68-3776 | 12-59-8866 CC PK RH | \$1,668.65 | 68-3881 | 59-8904 thru 76 Chassis Assy - LH | \$184.92 |
| * 68-3780 | 59-86/87/88/89 Rail Assy. F-Wide | \$2,839.70 | 68-3882 | 59-8904 thru 76 Chassis Assy - RH | \$184.92 |
| * 68-3781 | 59-86/87/88/89 Rail Assy. J-Wide | \$2,839.70 | * 68-3887 | 59-8900 Center Case Pak - LH | \$531.44 |
| * 68-3782 | 59-86/87/88/89 Rail Assy. G-Wide | \$2,839.70 | * 68-3888 | 59-8900 Center Case Pak - RH | \$531.44 |
| * 68-3784 | 12-59-86/87/88/89 Rail Assy. F-Wide | \$2,817.65 | * 68-3905 | Screw Pak | \$6.68 |
| * 68-3785 | 12-59-86/87/88/89 Rail Assy. J-Wide | \$2,817.65 | 68-3906 | Screw Pk B | \$38.75 |
| * 68-3786 | 12-59-86/87/88/89 Rail Assy. G-Wide | \$2,817.65 | 68-3917 | 12-HC-8804 Chas Assy. - Old Style | \$1,188.70 |
| * 68-3788 | Cam 59-83/84/85 F-Narrow | \$2,839.70 | 68-3918 | HC-8804 Chas Assy. - Old Style | \$990.62 |
| * 68-3789 | Cam 59-83/84/85 J-Narrow | \$2,839.70 | 68-3921 | HC-8800 Center Case | |
| * 68-3790 | Cam 59-83/84/85 G-Narrow | \$2,839.70 | | Pk - 04,10,13,15,40,43,44 functions | \$1,036.84 |
| * 68-3792 | 12-59-83/84/85 Rail Assy. F-Narrow | \$2,817.65 | 68-3922 | Screw Pak (12-8800) | \$15.81 |
| * 68-3793 | 12-59-83/84/85 Rail Assy. J-Narrow | \$2,817.65 | 68-3931 | PP,PR,SP&12-8700 Chassis Assy LH | \$221.78 |
| * 68-3794 | 12-59-83/84/85 Rail Assy. G-Narrow | \$2,817.65 | 68-3932 | 12-8700 Chassis Assy. RHR | \$221.78 |
| * 68-3797 | 19-59 Rail Assy 8F Wide | \$2,839.70 | 68-3933 | PP/PR/SP Top case | \$253.51 |
| * 68-3798 | 19-59 Rail Assy 8J Wide | \$2,839.70 | 68-3934 | Active Mortise Case - PP/SP8700 | \$582.55 |
| * 68-3799 | 19-59 Rail Assy 8G Wide | \$2,839.70 | 68-3935 | Inactive Mortise Case - PR8700 | \$462.33 |
| * 68-3801 | 12-19-59 Rail Assy 8F Wide | \$2,817.65 | 68-3940 | PP & PP12-8700 Lockbody Assy | \$630.51 |
| * 68-3802 | 12-19-59 Rail Assy 8J Wide | \$2,817.65 | 68-3941 | PR&PR12-8700 Lockbody Assy | \$391.83 |
| * 68-3803 | 12-19-59 Rail Assy 8G Wide | \$2,817.65 | 68-3945 | Active latchbolt assembly | \$176.06 |
| * 68-3805 | 19-59 Rail Assy 8F Narrow | \$2,839.70 | * 68-3953 | PP/PR/SP8700 T/C Pack | \$509.59 |
| * 68-3806 | 19-59 Rail Assy 8J Narrow | \$2,839.70 | * 68-3954 | PP/PR/SP8700 T/C Pack | \$509.59 |
| * 68-3807 | 19-59 Rail Assy 8G Narrow | \$2,839.70 | 68-3956 | Pusher rod assembly | \$43.17 |
| * 68-3809 | 12-19-59 Rail Assy 8F Narrow | \$2,817.65 | * 68-3973 | CC PK AL/GL-8804/10 LH | \$614.76 |
| * 68-3810 | 12-19-59 Rail Assy 8J Narrow | \$2,817.65 | * 68-3989 | CC PK 12AL/12GL 8804/10 | \$678.96 |
| * 68-3811 | 12-19-59 Rail Assy 8G Narrow | \$2,817.65 | * 68-4010 | AL- "8F" Wide Rail Assy. | \$1,606.94 |
| 68-3814 | Screw Pack (MD-8600) | \$17.61 | * 68-4011 | AL- "8J" Wide Rail Assy. | \$1,606.94 |
| * 68-3815 | MD- 8600 Chas Pack | \$638.36 | * 68-4012 | AL- "8G" Wide Rail Assy. | \$1,606.94 |
| 68-3823 | 12-59 & 59-8710 Chas Assy LHR | \$1,235.03 | * 68-4018 | AL-12- "8F" Wide Rail Assy. | \$1,606.94 |
| 68-3824 | 12-59 & 59-8710 Chas Assy RHR | \$1,235.03 | * 68-4019 | AL-12- "8J" Wide Rail Assy. | \$1,606.94 |
| 68-3826 | 12-59 & 59-8762/63 Chas Assy L | \$1,536.51 | * 68-4020 | AL-12- "8G" Wide Rail Assy. | \$1,606.94 |

*Specify hardware or painted finish required. Consult catalog for available finishes.

ED-64 EXIT DEVICES

SARGENT®

PARTS

ASSA ABLOY

USA & Canada Prices Effective June 3, 2019

| Part No. | Price | Part No. | Price |
|--|------------|--|------------|
| * 68-4022 AL- "8F" Nar Rail Asy. | \$1,606.94 | 68-4235 16 Function Lever Asy RHR 80 Ser. | \$198.09 |
| * 68-4023 AL- "8J" Nar Rail Asy. | \$1,606.94 | 68-4236 16 Function Lever Asy LHR 80 Ser. | \$198.09 |
| * 68-4024 AL- "8G" Nar Rail Asy. | \$1,606.94 | 68-4238 Inactive mortise case | \$583.33 |
| * 68-4025 AL- 8E Nar Rail. Asy. | \$1,606.94 | 68-4239 Active mortise case | \$803.46 |
| * 68-4030 AL-12- "8F" Nar Rail Asy. | \$1,606.94 | * 68-4242 L Low Profile Rail (36") (Cam) | \$1,100.68 |
| * 68-4031 AL-12- "8J" Nar Rail Asy. | \$1,606.94 | * 68-4243 M Low Profile Rail (42" or 44") | \$1,100.68 |
| * 68-4032 AL-12- "8G" Nar Rail Asy. | \$1,606.94 | * 68-4244 N Low Profile Rail (46" or 48") | \$1,100.68 |
| * 68-4033 AL-12 8E Nar Rail Assy | \$1,606.94 | * 68-4246 L 16- Low Profile Rail (36") | \$1,243.73 |
| * 68-4035 AL-19- "8F" Wide Rail Asy. | \$1,580.44 | * 68-4247 M 16- Low Profile Rail (42" or 44") | \$1,243.73 |
| * 68-4036 AL-19- "8J" Wide Rail Asy. | \$1,580.44 | * 68-4248 N 16- Low Profile Rail (46" or 48") | \$1,243.73 |
| * 68-4037 AL-19- "8G" Wide Rail Asy. | \$1,580.44 | * 68-4250 L 12- Low Profile Rail (36") | \$1,100.68 |
| * 68-4043 AL-12-19- "8F" Wide Rail Asy. | \$1,582.70 | * 68-4251 M 12- Low Profile Rail (42" or 44") | \$1,100.68 |
| * 68-4044 AL-12-19- "8J" Wide Rail Asy. | \$1,582.70 | * 68-4252 N 12- Low Profile Rail (46" or 48") | \$1,100.68 |
| * 68-4045 AL-12-19- "8G" Wide Rail Asy. | \$1,582.70 | * 68-4255 Mtg. Rail Insert - L | \$118.59 |
| * 68-4047 AL-19- "8F" Nar Rail Asy. | \$1,580.44 | * 68-4256 Mtg. Rail Insert - M | \$118.59 |
| * 68-4048 AL-19- "8J" Nar Rail Asy. | \$1,580.44 | * 68-4257 Mtg. Rail Insert - N | \$118.59 |
| * 68-4049 AL-19- "8G" Nar Rail Asy. | \$1,580.44 | 68-4261 Chassis Asy 8800 | \$445.12 |
| * 68-4050 AL-19- "8E" Nar Rail Asy. 32" only | \$1,580.44 | 68-4263 12-8888 CHASSIS ASY | \$454.47 |
| * 68-4055 AL-12-19- "8F" Nar Rail Asy. | \$1,580.44 | 68-4264 Chassis Asy LP/LR/LS + 12-8600 | \$499.75 |
| * 68-4056 AL-12-19- "8J" Nar Rail Asy. | \$1,580.44 | 68-4270 Upper Link asy LH | \$63.02 |
| * 68-4057 AL-12-19- "8G" Nar Rail Asy. | \$1,580.44 | 68-4271 Upper Link asy RH | \$63.02 |
| 68-4075 Chassis Asy AL-8816 LH | \$1,072.73 | * 68-4296 16-19 L RL LOW PROFILE | \$1,243.72 |
| 68-4076 Chassis Asy AL-8816 RH | \$1,072.73 | * 68-4297 16-19 M RL LOW PROFILE | \$1,243.72 |
| 68-4077 Chassis Asy AL-12-8816 LH | \$808.16 | * 68-4298 16-19 N RL LOW PROFILE | \$1,243.72 |
| 68-4078 Chassis Asy AL-12-8816 RH | \$808.16 | * 68-4305 55-Low Profile Rail Asy - L - (36") | \$1,388.84 |
| 68-4080 Chassis Asy AL-8828 LH | \$591.10 | * 68-4306 55-Low Profile Rail Asy - M - (42" or 44") | \$1,388.84 |
| 68-4081 Chassis Asy AL-8828 RH | \$591.10 | * 68-4307 55-Low Profile Rail Asy - N - (46" or 48") | \$1,388.84 |
| 68-4082 Chassis Asy AL-12-8828 LH | \$835.70 | * 68-4309 12-55-Low Profile Rail Asy - L - (36") | \$1,388.84 |
| 68-4083 Chassis Asy AL-12-8828 RH | \$835.70 | * 68-4310 12-55-Low Profile Rail Asy - M - (42" or 44") | \$1,388.84 |
| 68-4097 CHASSIS ASY AL-8863 LH | \$1,178.13 | * 68-4311 12-55-Low Profile Rail Asy - N - (46" or 48") | \$1,388.84 |
| 68-4098 CHASSIS ASY AL-8863 RH | \$1,178.13 | * 68-4322 55-56-Low Profile Rail Asy - L - (36") | \$2,252.36 |
| 68-4099 CHASSIS ASY AL-12-8863LH | \$1,381.64 | * 68-4323 55-56-Low Profile Rail Asy - M - (42" or 44") | \$2,252.36 |
| 68-4100 CHASSIS ASY AL-12-8863RH | \$1,381.64 | * 68-4324 55-56-Low Profile Rail Asy - N - (46" or 48") | \$2,252.36 |
| 68-4102 CHASSIS ASY AL-8866 LH | \$1,195.75 | * 68-4331 56-Low Profile Rail Asy - L - (36") | \$1,962.71 |
| 68-4103 CHASSIS ASY AL-8866 RH | \$1,195.75 | * 68-4332 56-Low Profile Rail Asy - M - (42" or 44") | \$1,962.71 |
| 68-4104 CHASSIS ASY AL-12-8866 LH | \$1,499.62 | * 68-4333 56-Low Profile Rail Asy - N - (46" or 48") | \$1,962.71 |
| 68-4105 CHASSIS ASY AL-12-8866 RH | \$1,499.62 | * 68-4335 19-56 "L" RL Low Profile | \$1,962.71 |
| 68-4112 CHASSIS ASY AL-8706&13 LH | \$1,355.76 | * 68-4336 19-56 "M" RL Low Profile | \$1,962.71 |
| 68-4113 CHASSIS ASY AL-8706&13 RH | \$1,355.76 | * 68-4337 19-56 "N" RL Low Profile | \$1,962.71 |
| 68-4115 Chassis Asy AL-8715,73,74 LH | \$1,219.98 | * 68-4340 58-Low Profile Rail Asy - L - (36") | \$1,512.98 |
| 68-4116 Chassis Asy AL-8715,73,74 RH | \$1,219.98 | * 68-4341 58-Low Profile Rail Asy - M - (42" or 44") | \$1,512.98 |
| 68-4118 Chassis Asy AL-8728 LH | \$1,204.43 | * 68-4342 58-Low Profile Rail Asy - N - (46" or 48") | \$1,512.98 |
| 68-4119 Chassis Asy AL-8728 RH | \$1,204.43 | * 68-4344 12-58-Low Profile Rail Asy - L - (36") | \$1,512.98 |
| 68-4121 Chassis Asy AL-8762&63LH | \$1,305.80 | * 68-4345 12-58-Low Profile Rail Asy - M - (42" or 44") | \$1,512.98 |
| 68-4122 Chassis Asy AL-8762&63RH | \$1,305.80 | * 68-4346 12-58-Low Profile Rail Asy - N - (46" or 48") | \$1,512.98 |
| 68-4124 Chassis Asy AL-8710 LH | \$1,004.33 | * 68-4357 55-58-Low Profile Rail Asy - L - (36") | \$1,800.81 |
| 68-4125 Chassis Asy AL-8710 RH | \$1,004.33 | * 68-4358 55-58-Low Profile Rail Asy - M - (42" or 44") | \$1,800.81 |
| 68-4127 Chassis Asy AL-8504,6,13 LH | \$1,259.46 | * 68-4359 55-58-Low Profile Rail Asy - N - (46" or 48") | \$1,800.81 |
| 68-4128 Chassis Asy AL-8504,6,13 RH | \$1,259.46 | * 68-4361 12-55-58-Low Profile Rail Asy - L - (36") | \$1,800.81 |
| 68-4129 Chassis Asy AL-8510 | \$1,042.48 | * 68-4362 12-55-58-Low Profile Rail Asy - M - (42" or 44") | \$1,800.81 |
| 68-4180 Active Mort. Case PP/SP8600 | \$803.46 | * 68-4363 12-55-58-Low Profile Rail Asy - N - (46" or 48") | \$1,800.81 |
| 68-4181 Inactive Mort. Case PR8600 | \$583.33 | 68-4373 Screw pack - low profile | \$13.55 |
| 68-4209 Extension Rod Assembly 12" | \$71.58 | 68-4383 Mounting plate pk low pro | \$40.78 |
| 68-4210 Extension Rod Assembly 18" | \$73.35 | 68-4389 SCREW PACK (W) | \$1.83 |
| 68-4211 Extension Rod Assembly 24" | \$76.86 | * 68-4406 Top & Bottom Pk (12-3700) | \$685.43 |

*Specify hardware or painted finish required. Consult catalog for available finishes.

USA & Canada Prices Effective June 3, 2019

| Part No. | Price | Part No. | Price |
|--|------------|--|------------|
| 68-4410 Chassis Asy (AL-/GL-) | \$313.89 | * 68-4649 12-53-58 J Wide Rail Assy | \$1,712.30 |
| 68-4411 Chassis Asy (12-AL/12-GL) | \$509.59 | * 68-4650 12-53-58 G Wide Rail Assy | \$1,712.30 |
| 68-4413 Latchbolt Asy - standard | \$26.19 | * 68-4651 53-58 E Narrow Rail Assy. | \$1,712.30 |
| 68-4415 Latchbolt Asy - Guarded | \$44.58 | * 68-4652 53-58 F Narrow Rail Assy. | \$1,712.30 |
| 68-4420 Chassis Asy (59-) | \$366.91 | * 68-4653 53-58 J Narrow Rail Assy | \$1,712.30 |
| 68-4421 Chassis Asy (12-59-) | \$540.17 | * 68-4654 53-58 G Narrow Rail Assy | \$1,712.30 |
| * 68-4449 Center Case for 8804,06,10,13,15 | \$989.45 | * 68-4655 16-53-58 E Narrow Rail Assy | \$1,861.96 |
| 68-4549 Bottom Case asy (8700) | \$157.49 | * 68-4656 16-53-58 F Narrow Rail Assy | \$1,861.96 |
| * 68-4551 8700 TOP/BOTTOM CASE PK | \$648.53 | * 68-4657 16-53-58 J Narrow Rail Assy | \$1,861.96 |
| * 68-4552 12-8700 Top/Btm case pk | \$484.50 | * 68-4658 16-53-58 G Narrow Rail Assy | \$1,861.96 |
| * 68-4554 14-8700 TOP/BTM CASE PK | \$648.53 | * 68-4659 12-53-58 E Narrow Rail Assy | \$1,712.30 |
| * 68-4555 12FM/FM8700 TOP&BOTTOM PK | \$647.05 | * 68-4660 12-53-58 F Narrow Rail Assy | \$1,712.30 |
| 68-4556 Bottom Case asy (14-8700) | \$111.16 | * 68-4661 12-53-58 J Narrow Rail Assy | \$1,712.30 |
| 68-4557 TOP CASE ASY (8700) | \$185.31 | * 68-4662 12-53-58 G Narrow Rail Assy | \$1,712.30 |
| 68-4558 BOTTOM CASE ASY (12-8700) | \$226.91 | * 68-4663 53-55-58 E Wide Rail Assy | \$2,000.16 |
| 68-4559 TOP CASE ASY (12-8700) | \$273.12 | * 68-4664 53-55-58 F Wide Rail Assy | \$2,000.16 |
| 68-4561 Top Case Asy (HC8700) | \$222.35 | * 68-4665 53-55-58 J Wide Rail Assy | \$2,000.16 |
| 68-4568 NB-8700 Chassis Asy (LHR) | \$473.24 | * 68-4666 53-55-58 G Wide Rail Assy | \$2,000.16 |
| 68-4569 NB-8700 Chassis Asy (RHR) | \$473.24 | * 68-4667 16-53-55-58 E Wide Rail Assy | \$2,149.85 |
| * 68-4570 Mtg. Rail Insert -E/F-narrow | \$118.59 | * 68-4668 16-53-55-58 F Wide Rail Assy | \$2,149.85 |
| * 68-4572 Mtg. Rail Insert - F-narrow | \$118.59 | * 68-4669 16-53-55-58 J Wide Rail Assy | \$2,149.85 |
| * 68-4574 Mtg. Rail Insert - F-55-8895 | \$81.89 | * 68-4670 16-53-55-58 G Wide Rail Assy | \$2,149.85 |
| * 68-4575 Mtg. Rail Insert -J/G-55-8895 | \$81.89 | * 68-4671 12-53-55-58 E Wide Rail Assy | \$2,000.16 |
| * 68-4577 NB-8700 (LH) CC PK | \$1,334.14 | * 68-4672 12-53-55-58 F Wide Rail Assy | \$2,000.16 |
| * 68-4578 NB-8700 (RH) CC PK | \$1,334.14 | * 68-4673 12-53-55-58 J Wide Rail Assy | \$2,000.16 |
| * 68-4579 Active Dummy Rail "J" | \$484.40 | * 68-4674 12-53-55-58 G Wide Rail Assy | \$2,000.16 |
| * 68-4580 55-Active Dummy Rail J | \$738.65 | * 68-4675 53-55-58 E Narrow Rail Assy | \$2,000.16 |
| * 68-4591 53- E Wide Rail Asy | \$1,269.78 | * 68-4676 53-55-58 F Narrow Rail Assy | \$2,000.16 |
| * 68-4592 53- F Wide Rail Asy | \$1,269.78 | * 68-4677 53-55-58 J Narrow Rail Assy | \$2,000.16 |
| * 68-4593 53- J Wide Rail Asy | \$1,269.78 | * 68-4678 53-55-58 G Narrow Rail Assy | \$2,000.16 |
| * 68-4594 53- G Wide Rail Asy | \$1,269.78 | * 68-4679 16-53-55-58 E Narrow Rail Assy | \$2,149.85 |
| * 68-4599 16-53- 8E Wide Rail Asy | \$1,423.60 | * 68-4680 16-53-55-58 F Narrow Rail Assy | \$2,149.85 |
| * 68-4600 16-53- 8F Wide Rail Asy | \$1,423.60 | * 68-4681 16-53-55-58 J Narrow Rail Assy | \$2,149.85 |
| * 68-4601 16-53- 8J Wide Rail Asy | \$1,423.60 | * 68-4682 16-53-55-58 G Narrow Rail Assy | \$2,149.85 |
| * 68-4602 16-53- 8J Wide Rail Asy | \$1,423.60 | * 68-4683 12-53-55-58 E Narrow Rail Assy | \$2,000.16 |
| 68-4615 53-55 E Wide Rail Assy. | \$1,439.19 | * 68-4684 12-53-55-58 F Narrow Rail Assy | \$2,000.16 |
| * 68-4616 53-55 F Wide Rail Assy. | \$1,439.19 | * 68-4685 12-53-55-58 J Narrow Rail Assy | \$2,000.16 |
| * 68-4617 53-55 J Wide Rail Assy. | \$1,439.19 | * 68-4686 12-53-55-58 G Narrow Rail Assy | \$2,000.16 |
| * 68-4618 53-55 G Wide Rail Assy. | \$1,439.19 | * 68-4687 12-53-56 F Wide Rail Assy | \$2,289.40 |
| * 68-4623 12-53-55- 8E Wide Rail Assy | \$1,612.89 | * 68-4688 12-53-56 J Wide Rail Assy | \$2,289.40 |
| * 68-4624 12-53-55- 8F Wide Rail Assy | \$1,612.89 | * 68-4689 12-53-56 G Wide Rail Assy | \$2,289.40 |
| * 68-4625 12-53-55- 8J Wide Rail Assy | \$1,612.89 | * 68-4690 12-53-56 F Narrow Rail Assy | \$2,289.40 |
| * 68-4626 12-53-55- 8G Wide Rail Assy | \$1,612.89 | * 68-4691 12-53-56 J Narrow Rail Assy | \$2,289.40 |
| * 68-4628 53-55 Narrow Rail Asy | \$1,525.58 | * 68-4692 12-53-56 G Narrow Rail Assy | \$2,289.40 |
| * 68-4639 53-58 E Wide Rail Assy. | \$1,712.30 | * 68-4693 12-53-55-56 F Wide Rail Assy | \$2,577.28 |
| * 68-4640 53-58 F Wide Rail Assy. | \$1,712.30 | * 68-4694 12-53-55-56 J Wide Rail Assy | \$2,577.28 |
| * 68-4641 53-58 J Wide Rail Assy | \$1,712.30 | * 68-4695 12-53-55-56 G Wide Rail Assy | \$2,577.28 |
| * 68-4642 53-58 G Wide Rail Assy | \$1,712.30 | * 68-4696 12-53-55-56 F Narrow Rail Assy | \$2,577.28 |
| * 68-4643 16-53-58 E Wide Rail Assy | \$1,861.96 | * 68-4697 12-53-55-56 J Narrow Rail Assy | \$2,577.28 |
| * 68-4644 16-53-58 F Wide Rail Assy | \$1,861.96 | * 68-4698 12-53-55-56 G Narrow Rail Assy | \$2,577.28 |
| * 68-4645 16-53-58 J Wide Rail Assy | \$1,861.96 | * 68-4743 19-53E Narrow Rail | \$1,269.78 |
| * 68-4646 16-53-58 G Wide Rail Assy | \$1,861.96 | * 68-4744 19-53F Narrow Rail | \$1,269.78 |
| * 68-4647 12-53-58 E Wide Rail Assy | \$1,712.30 | * 68-4745 19-53J Narrow Rail | \$1,269.78 |
| * 68-4648 12-53-58 F Wide Rail Assy | \$1,712.30 | * 68-4746 19-53G Narrow Rail | \$1,269.78 |

*Specify hardware or painted finish required. Consult catalog for available finishes.

ED-66 EXIT DEVICES

SARGENT®

PARTS

ASSA ABLOY

USA & Canada Prices Effective June 3, 2019

| Part No. | Price | Part No. | Price | | |
|-----------|---------------------------------|------------|---------------------------------|---|------------|
| * 68-4826 | 19-53-56-8F Wide Rail Assy | \$2,311.38 | * 68-5185 TL-59-8J NAR RAIL ASY | \$3,335.87 | |
| * 68-4827 | 19-53-56-8J Wide Rail Assy | \$2,311.38 | 68-5374 | CVR Top Case Assy - 1 3/4" door | \$198.45 |
| * 68-4828 | 19-53-56-8G Wide Rail Assy | \$2,311.38 | 68-5375 | CVR Top Case Assy - 1 3/4" door 1/4" cladding | \$198.45 |
| * 68-4829 | 19-53-56-8F Narrow Rail Assy | \$2,311.38 | 68-5376 | CVR Top Case Assy - 1 3/4" door 1/2" cladding | \$198.45 |
| * 68-4830 | 19-53-56-8J Narrow Rail Assy | \$2,311.38 | * 68-5377 | MD & 12-MD8600 LH C/C PK | \$1,285.24 |
| * 68-4831 | 19-53-56-8G Narrow Rail Assy | \$2,311.38 | * 68-5378 | MD & 12-MD8600 RH C/C PK | \$1,285.24 |
| * 68-4833 | Mtg. Rail Insert - F-wide | \$118.59 | * 68-5385 | WD & 12-WD8600 LH C/C PK | \$474.50 |
| 68-4838 | Connect Arm & Pin asy. | \$38.90 | * 68-5386 | WD & 12-WD8600 RH C/C PK | \$474.50 |
| 68-4840 | Latchbolt Assy - Guarded | \$34.91 | * 68-5389 | 59MD & 1259-MD8600 LH C/C | \$474.50 |
| * 68-4938 | 55-57 Rail Assy - F-wide | \$2,191.21 | * 68-5390 | 59MD & 1259-MD8600 RH C/C | \$474.50 |
| * 68-4939 | 55-57 Rail Assy - G-wide | \$2,191.21 | 68-5420 | Chassis mount screw pack | \$4.93 |
| * 68-4940 | 55-57 Rail Assy - J-wide | \$2,191.21 | * 68-5421 | Screw Pack J (12- 1-3/4") | \$33.10 |
| * 68-4942 | 12-55-57 Rail Assy - F-wide | \$2,191.21 | * 68-5423 | Screw Pack V (PP/PR/NB) | \$18.37 |
| * 68-4943 | 12-55-57 Rail Assy - G-wide | \$2,191.21 | 68-5424 | Screw Pack - HC8700 | \$9.65 |
| * 68-4944 | 12-55-57 Rail Assy - J-wide | \$2,191.21 | 68-5447 | 53-PP,PR,SP chassis assy LH | \$635.19 |
| * 68-4945 | 55-57 Rail Assy - E-narrow | \$2,191.21 | 68-5448 | 53-PP,PR,SP chassis assy RH | \$635.19 |
| * 68-4946 | 55-57 Rail Assy - F-narrow | \$2,191.21 | 68-5449 | Chassis Assy LH 53-NB | \$586.04 |
| * 68-4947 | 55-57 Rail Assy - G-narrow | \$2,191.21 | 68-5450 | Chassis Assy RH 53-NB | \$586.04 |
| * 68-4948 | 55-57 Rail Assy - J-narrow | \$2,191.21 | * 68-5462 | FM-E Rail Assy | \$1,323.75 |
| * 68-4949 | 12-55-57 Rail Assy - E-narrow | \$2,191.21 | * 68-5463 | FM-F Rail Assy | \$1,323.75 |
| * 68-4950 | 12-55-57 Rail Assy - F-narrow | \$2,191.21 | * 68-5464 | FM-J Rail Assy | \$1,323.75 |
| * 68-4951 | 12-55-57 Rail Assy - G-narrow | \$2,191.21 | * 68-5465 | FM-G Rail Assy | \$1,323.75 |
| * 68-4952 | 12-55-57 Rail Assy - J-narrow | \$2,191.21 | * 68-5466 | FM-12-E Rail Assy | \$1,493.87 |
| * 68-4953 | 19-53-55-56-8F W RAIL | \$2,577.28 | * 68-5467 | FM-12-F Rail Assy | \$1,493.87 |
| * 68-4954 | 19-53-55-56-8J Wide Rail Assy | \$2,577.28 | * 68-5468 | FM-12-J Rail Assy | \$1,493.87 |
| * 68-4955 | 19-53-55-56-8G Wide Rail Assy | \$2,577.28 | * 68-5469 | FM-12-G Rail Assy | \$1,493.87 |
| * 68-4956 | 19-53-55-56-8F Narrow Rail Assy | \$2,577.28 | * 68-5487 | FM-53-55-F Rail Assy | \$1,814.89 |
| * 68-4957 | 19-53-55-56-8J Narrow Rail Assy | \$2,577.28 | 68-5496 | Chassis Assy 8800 V.N1 | \$404.21 |
| * 68-4958 | 19-53-55-56-8G Narrow Rail Assy | \$2,577.28 | * 68-5514 | 19-55-56-8E Wide Rail Assy | \$2,121.08 |
| * 68-4976 | 55-AL Rail Assy - F-wide | \$1,903.37 | * 68-5527 | 19-53-55-56-8E Wide Rail Assy | \$2,577.28 |
| * 68-4977 | 55-AL Rail Assy - J-wide | \$1,903.37 | * 68-5542 | 56- 8E Wide Rail Assy | \$2,091.28 |
| * 68-4978 | 55-AL Rail Assy - G-wide | \$1,903.37 | * 68-5543 | RL/TCH BAR ASY W 55-56-8E | \$2,311.38 |
| * 68-4980 | 12-55-AL Rail Assy - F-wide | \$1,903.37 | * 68-5545 | RAIL ASY W 53-55-56-8E | \$2,387.99 |
| * 68-4981 | 12-55-AL Rail Assy - J-wide | \$1,903.37 | * 68-5546 | RL/TCH BAR ASY W HK-56-8E | \$2,094.61 |
| * 68-4982 | 12-55-AL Rail Assy - G-wide | \$1,903.37 | * 68-5547 | RL/TCH BAR ASY W HK-56-8F | \$2,094.61 |
| * 68-4983 | 55-AL Rail Assy - E-narrow | \$1,903.37 | * 68-5548 | RL/TCH BAR ASY W HK-56-8J | \$2,094.61 |
| * 68-4984 | 55-AL Rail Assy - F-narrow | \$1,903.37 | * 68-5549 | RL/TCH BAR ASY W HK-56-8G | \$2,094.61 |
| * 68-4985 | 55-AL Rail Assy - J-narrow | \$1,903.37 | * 68-5550 | RL/TCH BAR W HK-55-56-8E | \$2,311.39 |
| * 68-4986 | 55-AL Rail Assy - G-narrow | \$1,903.37 | * 68-5551 | RL/TCH BAR W HK-55-56-8F | \$2,311.39 |
| * 68-4987 | 12-55-AL Rail Assy - F-narrow | \$1,903.37 | * 68-5552 | RL/TCH BAR W HK-55-56-8J | \$2,311.39 |
| * 68-4988 | 12-55-AL Rail Assy - J-narrow | \$1,903.37 | * 68-5553 | RL/TCH BAR W HK-55-56-8G | \$2,311.39 |
| * 68-4989 | 12-55-AL Rail Assy - G-narrow | \$1,903.37 | * 68-5554 | RAIL ASY W HK-53-56-8E | \$2,387.99 |
| * 68-4990 | 12-55-AL Rail Assy - E-narrow | \$1,903.37 | * 68-5559 | RAIL ASY W HK-53-55-56-8F | \$2,387.99 |
| 68-5045 | Screw pack MD8600 1/4 | \$16.55 | * 68-5560 | RAIL ASY W HK-53-55-56-8J | \$2,387.99 |
| 68-5046 | Screw pack MD8600 1/2 | \$16.73 | 68-5562 | RL/TCH Bar Assy W 16-56-8E | \$2,158.64 |
| * 68-5048 | TL-8E RAIL ASY | \$1,223.90 | 68-5563 | RL/TCH Bar Assy W 16-56-8F | \$2,158.64 |
| * 68-5049 | TL-8F RAIL ASY | \$1,223.90 | 68-5564 | RL/TCH Bar Assy W 16-56-8J | \$2,158.64 |
| * 68-5050 | TL-8G RAIL ASY | \$1,223.90 | 68-5565 | RL/TCH Bar Assy W 16-56-8G | \$2,158.64 |
| * 68-5051 | TL-8J RAIL ASY | \$1,223.90 | * 68-5566 | 16-55-56-8E Wide Rail Assy | \$2,367.32 |
| 68-5068 | MD8600 Chassis assy. (LHR) | \$501.31 | * 68-5567 | 16-55-56-8F Wide Rail Assy | \$2,367.32 |
| 68-5069 | MD8600 CHASSIS ASY (RHR) | \$501.31 | * 68-5568 | 16-55-56-8J Wide Rail Assy | \$2,367.32 |
| 68-5070 | 59-8600 CHASSIS ASY (LH) | \$510.26 | * 68-5569 | 16-55-56-8G Wide Rail Assy | \$2,367.32 |
| 68-5071 | 59-8600 CHASSIS ASY (RH) | \$510.26 | * 68-5575 | 16-53-55-56-8F Wide Rail Assy | \$2,559.37 |
| * 68-5073 | TL-55-8F RAIL ASY | \$1,903.90 | * 68-5578 | 56- 8E Narrow Rail Assy | \$2,091.28 |

*Specify hardware or painted finish required. Consult catalog for available finishes.

USA & Canada Prices Effective June 3, 2019

| Part No. | Price | Part No. | Price | | |
|-----------|-------------------------------------|------------|-----------|---|------------|
| * 68-5579 | 55-56- 8E Narrow Rail Assy | \$2,161.79 | * 68-7128 | 16-19-53-55-8F Narrow Rail Assy | \$1,566.93 |
| * 68-5582 | 19-56- 8E Narrow Rail Assy | \$1,916.22 | 68-7306 | FM8713 Chassis Assy LHR | \$531.42 |
| * 68-5587 | HK-56-8F Narrow Rail Assy | \$2,001.59 | 68-7307 | FM8713 Chassis Assy RHR | \$531.42 |
| * 68-5590 | HK-55-56- 8E Narrow Rail Assy | \$2,311.39 | 68-7308 | FM8700 Chassis Assy LHR | \$286.95 |
| * 68-5591 | HK-55-56- 8F Narrow Rail Assy | \$2,311.39 | 68-7309 | FM8700 Chassis Assy RHR | \$286.95 |
| * 68-5592 | HK-55-56- 8J Narrow Rail Assy | \$2,311.39 | 68-7312 | FM 8715 Chassis Assy LHR | \$514.52 |
| * 68-5593 | HK-55-56- 8G Narrow Rail Assy | \$2,311.39 | 68-7313 | FM 8715 Chassis Assy RHR | \$514.52 |
| * 68-5618 | RL/TCH Bar Assy N 16-56-8E | \$2,153.65 | 68-7409 | 53-Chassis Assy | \$312.44 |
| * 68-5619 | RL/TCH Bar Assy N 16-56-8F | \$2,153.65 | 68-7410 | 12-53-Chassis Assy | \$354.10 |
| * 68-5620 | RL/TCH Bar Assy N 16-56-8J | \$2,153.65 | 68-7411 | Chassis Assy (53-8500) | \$594.76 |
| * 68-5621 | RL/TCH Bar Assy N 16-56-8G | \$2,153.65 | * 68-7412 | 53-8504,06,10,13,15,73,74 C/C | \$956.80 |
| * 68-5622 | 16-55-56- 8E Narrow Rail Assy | \$2,289.40 | 68-7546 | Motor Actuator Assy | \$100.05 |
| * 68-5623 | 16-55-56- 8F Narrow Rail Assy | \$2,289.40 | * 76-0027 | Knob collar | \$11.98 |
| * 68-5624 | 16-55-56- 8J Narrow Rail Assy | \$2,289.40 | 76-0563 | Spiral pin | \$0.42 |
| * 68-5625 | 16-55-56- 8G Narrow Rail Assy | \$2,289.40 | 77-0086 | Inside knob shank | \$32.26 |
| * 68-5634 | 16-19-56- 8E Narrow Rail Assy | \$2,091.28 | 77-0189 | Rose bushing insert | \$1.56 |
| * 68-5635 | 16-19-56- 8F Narrow Rail Assy | \$2,091.28 | * 77-0550 | Rose bushing | \$21.59 |
| * 68-5636 | 16-19-56- 8J Narrow Rail Assy | \$2,091.28 | * 77-0883 | ASA Strike Crvd Lip 1-1/4" | \$33.86 |
| * 68-5637 | 16-19-56- 8G Narrow Rail Assy | \$2,091.28 | 77-3915 | Half spindle unit 8300 & 8900 1-3/4"-2-1/4" doors | \$29.12 |
| * 68-5647 | 16-19-53-55-56- 8F Narrow Rail Assy | \$2,704.19 | 77-3916 | Half spindle unit 8300 & 8900 2-1/4" - 3" doors | \$29.12 |
| * 68-5648 | 16-19-53-55-56- 8J Narrow Rail Assy | \$2,704.19 | 77-3917 | Half spindle unit 8300 & 8900 over 3" doors | \$43.69 |
| * 68-5650 | 16-19-56- 8E Wide Rail Assy | \$2,091.28 | 94-0018 | Inner chassis spring | \$15.93 |
| * 68-5651 | 16-19-56- 8F Wide Rail Assy | \$2,091.28 | 94-0038 | Bottom bolt | \$68.56 |
| * 68-5652 | 16-19-56- 8J Wide Rail Assy | \$2,091.28 | 94-0039 | Bolt sleeve | \$88.93 |
| * 68-5653 | 16-19-56- 8G Wide Rail Assy | \$2,091.28 | 94-0051 | Lever locking plate | \$4.07 |
| 68-5820 | SCREW PACK FM8700 | \$26.05 | 94-0054 | Lever spring | \$21.37 |
| 68-5821 | Screw pack 56 Kit | \$16.48 | * 94-0056 | Cylinder blocking ring (41 & 71 size) | \$11.38 |
| 68-5880 | New Style 8500 Chassis asy | \$298.86 | * 94-0058 | Cylinder blocking ring (42 & 72 size) | \$14.55 |
| 68-5881 | (GL-8500) Chassis asy | \$333.52 | 94-0106 | Pin | \$1.55 |
| 68-5882 | (59-8500) Chassis asy | \$582.40 | 94-0109 | Spring | \$13.87 |
| * 68-5989 | 59-8500 UNIV C-CASE PK | \$1,057.48 | 94-0110 | Cam | \$9.32 |
| * 68-5990 | 8500 (STD) UNIV C-CASE PK | \$644.06 | 94-0112 | Locking lever (306) | \$22.93 |
| 68-5991 | Mounting plate screw pack | \$12.66 | 94-0113 | Locking lever | \$22.93 |
| 68-5992 | GL-8500 UNIV C-CASE PK | \$685.26 | 94-0114 | Locking lever (113, 313) | \$22.93 |
| 68-5944 | 8400 CHASSIS AY CLAD LHRB | \$483.83 | * 94-0119 | Cover | \$81.12 |
| 68-5945 | 8400 CHASSIS AY CLAD RHRB | \$483.83 | 94-0188 | Lifting Lever | \$13.68 |
| 68-5946 | 8400 CHASSIS AY 1/2" CLAD LHRB | \$501.31 | * 94-0189 | Cylinder Operation Escutcheon | \$162.83 |
| 68-5951 | 8400 CHASSIS AY 1/2" CLAD RHRB | \$501.31 | * 94-0190 | Crossbar for 9400 only | \$338.75 |
| 68-6013 | 8400 CHASSIS AY 1/4" CLAD LHRB | \$500.59 | * 94-2376 | Center Case, Active RHRB | \$569.98 |
| 68-6014 | 8400 CHASSIS AY 1/4" CLAD RHRB | \$500.59 | * 94-2377 | Center Case, Active LHRB | \$569.98 |
| 68-6021 | 8500 Latch Bolt Assy | \$26.19 | * 94-2378 | Fire Rated Center Case, Active RHRB | \$1,139.94 |
| 68-6042 | Chassis Assy HC4 8706/13 LHRB | \$1,279.55 | * 94-2379 | Fire Rated Center Case, Active LHRB | \$1,139.94 |
| 68-6043 | Chassis Assy HC4 8706/13 RHRB | \$1,279.55 | * 94-2380 | 9410 RHRB C/C Inactive | \$563.16 |
| 68-6044 | Chassis Assy HC4 8715/73/74 LHRB | \$1,279.55 | * 94-2381 | 9410 LHRB C/C Inactive | \$563.16 |
| 68-6045 | Chassis Assy HC4 8715/73/74 RHRB | \$1,279.55 | * 94-2384 | Tenon Packet | \$61.88 |
| 68-6046 | Chassis Assy HC4 8710 LHRB | \$1,279.55 | 94-2385 | Top Latch Assembly | \$301.29 |
| 68-6047 | Chassis Assy HC4 8710 RHRB | \$1,279.55 | 94-2386 | Bottom Bolt Assembly (26D only) | \$325.72 |
| * 68-7111 | 19-53-55-8E Wide Rail Assy | \$1,439.19 | 94-2387 | Screw Pack (mounting screws) | \$22.32 |
| * 68-7112 | 9-53-55-8F Wide Rail Assy | \$1,439.19 | 94-2390 | Top Strike Pack | \$48.91 |
| * 68-7113 | 19-53-55-8J Wide Rail Assy | \$1,439.19 | 94-2391 | Bottom Strike Pack | \$35.82 |
| * 68-7119 | 12-19-53-55-8E Wide Rail Assy | \$1,609.49 | 94-2008 | Inner case assembly (8400 x control x no trim) | \$262.71 |
| * 68-7120 | 12-19-53-55-8F Wide Rail Assy | \$1,609.49 | 94-2016 | Bottom Case & Bolt Assy 8400 | \$314.18 |
| * 68-7121 | 12-19-53-55-8J Wide Rail Assy | \$1,609.49 | 94-2087 | Lever assembly (106, 113) | \$38.05 |
| * 68-7122 | 12-19-53-55-8G Wide Rail Assy | \$1,609.49 | 94-2088 | Lever assembly (313) | \$38.05 |

*Specify hardware or painted finish required. Consult catalog for available finishes.

PARTS

USA & Canada Prices Effective June 3, 2019

| Part No. | Price | Part No. | Price | | |
|----------|--|----------|----------|---|----------|
| 94-2089 | Chassis assembly | \$279.25 | 97-0270 | Top reinforcement | \$18.91 |
| *94-2121 | Turn lever assembly | \$119.24 | *97-0285 | Inside lever 306/313 control (8700) | \$245.33 |
| 94-2249 | Locking lever & pin assy. (106) | \$35.53 | *97-0286 | Plate (828) | \$270.93 |
| 94-2329 | Lever Assembly 206-306 | \$35.53 | *97-0291 | Plate (842) | \$151.07 |
| 94-2441 | Bottom rod and bolt kit for FM7100 | \$477.78 | 97-0294 | Pivot pin | \$3.86 |
| 94-2442 | Bottom Bolt Strike Pack | \$65.80 | 97-0295 | Top Chassis 9700 | \$57.63 |
| 96-0061 | Inner chassis bracket | \$31.08 | 97-0296 | Latchbolt | \$60.03 |
| 97-0001 | Dogging key | \$3.68 | 97-0298 | Top slide | \$13.14 |
| 97-0006 | Locking slide spring (specify hand) | \$22.77 | 97-0300 | Spring | \$15.05 |
| *97-0008 | End plug for 90 series | \$14.33 | *97-0302 | Cylinder ring 7-pin | \$22.60 |
| 97-0012 | Main arm spring | \$2.39 | 97-0305 | Insert | \$1.29 |
| *97-0015 | 12-90 Bracket Cover | \$181.18 | *97-0309 | Plate (874DT) | \$151.07 |
| *97-0018 | Cover Top & Bottom for 8700 | \$124.42 | *97-0311 | Plate (894) | \$151.07 |
| *97-0020 | Guide | \$38.40 | *97-0312 | Plate (884) | \$151.07 |
| 97-0029 | Bracket pivot pin | \$7.89 | *97-0313 | Plate (874) | \$151.07 |
| 97-0030 | Pivot pin | \$7.89 | 97-0347 | Locking slide spring | \$5.69 |
| 97-0031 | Main arm spacer | \$2.39 | *97-0349 | 16-Cylinder Collar 41 Cylinder | \$10.64 |
| 97-0032 | Main slide | \$109.02 | *97-0350 | Collar 41 & 71 (706, 713) (Arrow, Best, Falcon 16-) | \$16.47 |
| 97-0035 | Retractor | \$11.38 | *97-0351 | Collar 42 & 72 (706, 713) | \$16.47 |
| 97-0036 | Sliding bolt | \$56.71 | *97-0352 | Collar 43 (706, 715) | \$16.47 |
| 97-0037 | Knob slide | \$56.71 | 97-0356 | Locking Slide | \$45.88 |
| 97-0039 | Bottom sliding bolt | \$65.35 | 97-0360 | Spring Link | \$2.24 |
| 97-0040 | Bushing | \$6.05 | 97-0362 | Hub Spring | \$1.31 |
| 97-0042 | Knob hub | \$45.16 | *97-0367 | Grip | \$263.95 |
| 97-0043 | Knob hub retainer | \$7.89 | *97-0392 | Top cover After (1/92) for 12-8700 | \$124.43 |
| 97-0045 | Bushing pin | \$2.39 | 97-0425 | Spring | \$10.11 |
| 97-0046 | Retaining pin | \$2.39 | 97-0454 | Bottom Bolt Spring | \$2.56 |
| 97-0048 | Rod adj. pin | \$1.29 | 97-0475 | FW743 Locking Slide | \$54.53 |
| 97-0049 | Rod adj. pin (13-9700) | \$1.29 | 97-0477 | FW-ET Bushing Insert | \$8.10 |
| 97-0050 | Spring | \$2.02 | 97-0508 | Lower Hub Plate FW700(-5,-8) | \$4.45 |
| 97-0051 | Spring | \$2.02 | 97-0527 | RETAINING RING | \$1.09 |
| *97-0052 | Screw | \$0.64 | 97-0551 | 2-1/4" lockable spindle | \$30.28 |
| 97-0053 | Latchbolt | \$60.03 | *97-0562 | 2 Plate (PSB) | \$159.83 |
| *97-0058 | Grip | \$270.93 | 97-0566 | "J" lever spring | \$10.11 |
| *97-0060 | Grommet nut | \$7.89 | 97-0568 | Wrench – Cyl. Nut | \$15.15 |
| *97-0064 | Grip | \$270.93 | 97-0573 | Spindle (04 & 10 function) | \$6.75 |
| 97-0075 | Lift lever | \$9.37 | 97-0577 | Main slide - 9700 | \$92.05 |
| 97-0076 | Sliding bolt | \$105.57 | 97-0579 | Spring (Torsion) | \$1.73 |
| 97-0079 | Filler cap | \$90.70 | 97-2001 | Locking slide Assy. 9700 | \$22.60 |
| *97-0084 | Cover 12-8700 top case (old/before 1/92) | \$129.57 | 97-2002 | 12-Bot. case Assy. less cover (Old Style) | \$451.53 |
| *97-0086 | Cover 12-9700 (center cover) | \$226.70 | 97-2003 | 12-Top case Assy. less cover (Old Style) | \$540.74 |
| *97-0087 | Cover (12-bottom cover) | \$129.57 | 97-2038 | Bot. case Assy. less cover (Before 11/11/02) | \$322.66 |
| 97-0089 | Thumb piece lever | \$67.18 | 97-2039 | 14-Bottom case Assy. less cover (Before 11/11/02) | \$140.09 |
| 97-0090 | Thumb piece slide | \$67.18 | *97-2040 | 9710 Ctr Case Asy | \$609.68 |
| 97-0101 | Retractor spring | \$7.89 | *97-2042 | 9706/13 Ctr Case Asy | \$692.07 |
| *97-0114 | Plate (818) | \$270.93 | 97-2046 | Top slide/roll pin Assy. | \$131.79 |
| 97-0119 | Thru bolt stud | \$11.38 | 97-2048 | Cylinder hub Assy. | \$30.10 |
| *97-0122 | Plate (838) | \$270.93 | *97-2237 | Ctr Sub Case - 12-9710 | \$774.44 |
| 97-0131 | Thumb piece backup plate | \$9.37 | *97-2240 | Ctr Sub Case - 12-9706 & 13 | \$856.84 |
| 97-0156 | Oval head rivet | \$0.64 | *97-2302 | Ctr Sub Case - 12-9762 & 63 | \$906.26 |
| *97-0182 | Thumb piece (LHR) | \$112.72 | *97-2369 | 9710 C.C. Pack | \$823.88 |
| *97-0189 | Thumb piece (RHR) | \$112.72 | *97-2371 | 9706/13 C.C. Pack | \$906.26 |
| *97-0203 | Thumb piece (LH) | \$120.78 | *97-2378 | Inside lever Assy. (9700) | \$245.33 |
| *97-0214 | Thumb piece (RH) | \$120.78 | *97-2381 | 9715 Center case assy | \$615.46 |

*Specify hardware or painted finish required. Consult catalog for available finishes.

USA & Canada Prices Effective June 3, 2019

| Part No. | Price | Part No. | Price | | |
|----------|---|------------|----------|--|------------|
| *97-2384 | 9728 Center case assy | \$659.11 | *98-2161 | 9898 CTR Case Pk. | \$721.79 |
| *97-2402 | 9715 Center case pack | \$823.88 | *98-2162 | Bracket Pack (includes cover) | \$390.36 |
| *97-2404 | 9728 Center case pack | \$873.28 | *98-2163 | 9898 Ctr Case Assy. (less cover) | \$504.20 |
| *97-2406 | Ctr Sub Case - 12-9715 | \$774.44 | *98-2469 | 12-9804 LHRB Chassis asy | \$1,229.79 |
| *97-2407 | Ctr Sub Case - 12-9728 | \$823.88 | *98-2470 | 12-9804 RHRB Chassis asy | \$1,229.79 |
| 97-2434 | Top case Assy. less cover (Before 11/11/02) | \$384.90 | *98-2479 | 12-9863 LHRB Chassis Assy | \$1,211.15 |
| 97-2854 | Chassis Assy - (12-)9715 | \$453.54 | *98-2480 | 12-9863 RHRB Chassis Assy | \$1,211.15 |
| *97-2868 | Top & Bottom Case Pack (Before 11/11/02) | \$948.94 | *98-2492 | Center Case Pk LHRB | \$1,057.62 |
| *97-2952 | Screw Pak 800 Series | \$14.12 | *98-2493 | Center Case Pk RHRB | \$1,057.62 |
| *97-2953 | Screw Pak 800 Series | \$10.07 | *98-2496 | Center Case Pk LHRB (12-9863) | \$1,167.55 |
| 97-2963 | 12-Top case Assy. (Before 11/11/02) | \$432.82 | *98-2497 | Center Case Pk RHRB (12-9863) | \$1,167.55 |
| *97-2972 | Ctr Case Pk - 12-9710 | \$988.64 | *98-2503 | Chassis Assy. 9804 | \$523.30 |
| *97-2973 | Ctr Case PK - 12-9715 | \$988.64 | *98-2504 | Chassis Assy 9810 | \$523.30 |
| *97-2974 | Ctr Case Pk - 12-9728 | \$1,038.08 | *98-2505 | Chassis Assy 9813 | \$892.75 |
| *97-2975 | Ctr Case Pk - 12-9706 & 13 | \$1,071.02 | *98-2506 | Chassis Assy 9815 | \$892.75 |
| *97-2976 | Ctr Case Pk - 12-9762 & 63 | \$1,120.46 | *98-2507 | CHASSIS ASY 9828 | \$523.30 |
| 97-3066 | Switch & Cable Assy. | \$80.74 | *98-2510 | CTR CASE PK 9804 | \$1,019.32 |
| 97-3092 | FW SPIN ASY 1 3/4 (700&8) | \$13.25 | *98-2511 | CTR CASE PK 9810 | \$1,040.07 |
| 97-3098 | FW Spindle Asy 1-3/4" | \$44.40 | *98-2512 | CTR CASE PK 9813 | \$982.81 |
| 97-3137 | Switch/Mtg. Plate Assy. | \$224.11 | *98-2513 | CTR CASE PK 9815 | \$1,092.11 |
| 97-3230 | 16- Cylinder Dogging Assy | \$37.93 | *98-2515 | CTR CASE PK 9863 | \$997.45 |
| 98-0009 | Latchbolt lever LHRB | \$18.91 | *98-2517 | CHASSIS ASY 9800 (75,76) | \$922.31 |
| 98-0010 | Latchbolt lever RHRB | \$18.91 | 98-2518 | L980 & L980A Assembly | \$403.83 |
| 98-0011 | Lever pivot pin | \$5.69 | 98-2520 | 12-L980 Latch Assy (Retrofits L980S) | \$403.83 |
| 98-0018 | Outside cylinder hub | \$21.87 | 98-2597 | 12-HCL980 Latch Assy (Retrofits HC-L980) | \$422.17 |
| 98-0020 | Cylinder support | \$29.29 | *99-0007 | Cylinder ring 16 & 66 | \$46.59 |
| *98-0021 | Cylinder blocking ring | \$22.60 | 99-0009 | Mortise lock lever RHRB | \$46.59 |
| 98-0027 | Spring | \$2.02 | 99-0010 | Mortise lock lever LHRB | \$46.59 |
| 98-0028 | Latchbolt spring | \$2.39 | 99-0011 | Pivot pin | \$3.94 |
| 98-0036 | Shim for 646/649 | \$24.97 | *99-0012 | 12-9900 Cover | \$231.11 |
| *98-0049 | Plate (818) | \$143.89 | 99-0057 | Guardbolt spring | \$2.07 |
| 98-0071 | Thru bolt stud | \$18.21 | 99-0058 | Slide guide | \$3.94 |
| 98-0111 | Main arm spring | \$2.02 | 99-0060 | Guardbolt lever | \$3.94 |
| *98-0112 | Arm 97, 98, 99, 9898 Exit Device | \$103.06 | 99-0061 | Thumb piece lever spring | \$2.07 |
| 98-0115 | Compression Spring | \$2.02 | 99-0063 | Guardbolt lever spring | \$2.07 |
| *98-0117 | Bracket cover 9700 & 9898 | \$181.18 | 99-0072 | Guardbolt eyelet | \$1.87 |
| *98-0118 | Plate PTB-98K | \$143.89 | 99-0075 | Anti-Friction bolt | \$38.50 |
| *98-0119 | Plate PTB-98T | \$143.89 | 99-0076 | Slide space | \$3.94 |
| 98-0123 | Latchbolt | \$69.93 | 99-0077 | Guardbolt tail piece | \$2.07 |
| 98-0124 | Thumb piece lever | \$24.62 | 99-0078 | Cylinder set screw | \$2.07 |
| *98-0125 | Plate (98E) | \$143.89 | 99-0088 | Thumb piece lever | \$25.08 |
| *98-0126 | Plate (98D) | \$143.89 | 99-0098 | Anti-Friction bolt pivot pin | \$3.94 |
| 98-0155 | Main arm spring | \$2.56 | 99-0206 | Knob hub | \$46.59 |
| *98-0209 | Cover 9898 | \$125.91 | 99-0208 | Locking lever | \$11.61 |
| *98-0233 | Cover (12-9800) LHRB | \$125.91 | 99-0212 | Pin | \$1.31 |
| *98-0234 | Cover (12-9800) RHRB | \$125.91 | *99-0216 | Front RHRB 963, 928 | \$146.71 |
| 98-0248 | Guide Pin | \$14.26 | *99-0217 | Front LHRB 963, 928 | \$146.71 |
| 98-0276 | Collar-12-L980 | \$14.80 | *99-0218 | Front LHR flat 963, 928 | \$146.71 |
| 98-0277 | Collar-EL980 | \$14.80 | *99-0219 | Front RHR flat 963, 928 | \$146.71 |
| *98-2011 | Bracket Pack 12- (includes cover | \$409.84 | 99-0223 | Slide guide | \$7.47 |
| 98-2034 | L.B. & Pin Assy LHRB 20, 60, 90 | \$50.48 | 99-0224 | Thumb Piece Lever | \$36.09 |
| 98-2035 | L.B. & Pin Assy RHRB 20, 60, 90 | \$50.48 | *99-0226 | Front LHRB for 916, 966 | \$146.71 |
| *98-2156 | Arm 9800 | \$122.81 | *99-0227 | Front RHRB for 916, 966 | \$146.71 |
| 98-2159 | Bolt spring & bracket Assy. | \$29.00 | *99-0228 | Front LHR flat for 916, 966 | \$146.71 |

*Specify hardware or painted finish required. Consult catalog for available finishes.

ED-70 EXIT DEVICES

SARGENT®

ASSA ABLOY

PARTS

USA & Canada Prices Effective June 3, 2019

| Part No. | | Price |
|----------|-----------------------------|------------|
| *99-0229 | Front RHR flat for 916, 966 | \$146.71 |
| 99-0236 | Cylinder clamp | \$7.87 |
| 99-0249 | Roll pin for 916, 966 | \$0.98 |
| 99-0279 | Guardbolt Assy. LHRB | \$84.39 |
| 99-0280 | Guardbolt Assy. RHRB | \$84.39 |
| 99-2035 | Guardbolt Assy. LHRB | \$29.58 |
| 99-2036 | Guardbolt Assy. RHRB | \$29.58 |
| 99-2050 | Slide, bushing Assy. | \$61.16 |
| 99-2052 | Guardbolt Assy. | \$30.86 |
| 99-2059 | Lever slide Assy. | \$15.36 |
| 99-2247 | Latchbolt Assy. | \$153.96 |
| 99-2389 | Latchbolt lever Assy. | \$61.16 |
| *99-2511 | CTR CSE SUB-ASSY LHRB | \$710.22 |
| *99-2512 | CTR CSE SUB-ASSY RHRB | \$710.22 |
| *99-2520 | 9900 CC PK LHRB | \$1,299.21 |
| *99-2521 | 9900 CC PK RHRB | \$1,299.21 |
| *99-2525 | 12-9900 CC PK LHRB | \$1,299.21 |
| *99-2526 | 12-9900 CC PK RHRB | \$1,299.21 |

*Specify hardware or painted finish required. Consult catalog for available finishes.

ASSA ABLOY, the global leader
in door opening solutions

Copyright © 2002-2019 Sargent Manufacturing Company, an ASSA ABLOY Group company. All rights reserved.
Reproduction in whole or in part without the express written permission of Sargent Manufacturing Company is prohibited.
Contact us at: 800-727-5477 or visit www.sargentlock.com. In Canada contact us at: 800-461-3007 or visit www.assaabloydss.ca

AUXILIARY LOCKS

| | |
|-------------------------------------|------|
| 470-SSL1 Series Auxiliary Lock..... | AL-1 |
| 480 Series Deadbolt..... | AL-2 |
| 4870 Series Mortise Deadlock..... | AL-3 |
| 460-480-4870 Strikes & Parts..... | AL-4 |
| 4870 Parts..... | AL-5 |

Locker & Utility Locks

| | |
|-----------------------------|------|
| Locker & Utility Locks..... | AL-6 |
| Padlock-758..... | AL-7 |
| Padlock-858..... | AL-8 |

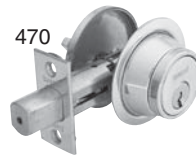

USA & Canada Prices Effective June 3, 2019

| 470 Series | | |
|-------------------|---|-------------------|
| Options | Description | Price |
| 1 | 1-3/8" to 1-3/4" thick door adapter | No addition |
| 10 | SARGENT Signature System | Add \$58.00 /cyl. |
| 11 | SARGENT XC Key System (not available with 10, 22, SC, SE options) | No addition |
| 13 | Front and strike with 1/4" radius corners | No addition |
| 15 | Drive-in adjustable backset bolt x 26D only | No addition |
| *21 | SARGENT Construction Key System (lost ball) | Add \$16.00 /cyl. |
| 28 | 408 Flat lip strike 4-7/8" x 1-1/4" ANSI A115.2 | No addition |
| BR | SARGENT Bump Resistant Cyls. (N/A w/10, 22, 30, 60, 63, 64, 70, 72, 73, 737P, KESO, SC, & SE options) | Add \$23.00 /cyl. |
| LC | Less Cylinder | No Deduct |
| SC | Schlage "C" keyway cylindrical (0-Bitted) | No Addition |
| SE | Schlage "E" keyway cylindrical (0-Bitted) | No addition |

* Refer to CK-3 for additional masterkeying charges when using this option.

| 470 Series Bored Deadbolt | | Finish | |
|----------------------------------|-------------------------------------|-------------------------|------------------------|
| Number | Description | 10BE/26D/BSP/WSP | 03/04/10/10B/26 |
| 474 | Double Cylinder | \$144.00 | \$151.00 |
| 475 | Single Cylinder by thumbturn inside | \$111.00 | \$116.00 |
| 479 | No cylinder, thumbturn inside | \$81.00 | \$85.00 |

| 470 Parts | Description | 03/04/10/10B/10BE/26/26D/BSP/WSP |
|------------------|--|---|
| 16-0321 | Plastic filler to allow standard bolt to fit a standard 161 door prep (No finish needed) | \$1.98 |
| 16-0322 | Spacer Ring (for 1- option) | \$11.79 |
| 16-0331 | Spacer Ring (1-3/8" Door – 1- option) | \$11.79 |
| 16-2495 | Standard adjustable backset bolt (2-3/8" or 2-3/4" backsets) | \$43.27 |
| 16-2496 | 1/4" radius corner adjustable backset bolt (2-3/8" or 2-3/4" backsets) | \$43.27 |
| 16-2497 | Adjustable backset drive-in bolt (2-3/8" or 2 3/4" backsets) | \$43.27 |

| 470 Strikes | Description | 10BE/26D/BSP/WSP | 03/04/10/10B/26 |
|--------------------|--|-------------------------|------------------------|
| 406 | Standard Strike | | |
| 407 | 1/4" Radius Strike | \$12.79 | \$14.14 |
| 408 | Flat Lip Strike 4-7/8"x 1-1/4" - (28-) | \$21.09 | \$29.93 |

Note: Split finishes are not available for 470's.

| SSL1 Options | Description | Price |
|---------------------|---|--------------|
| SG | MicroShield® an antimicrobial powder coat | \$40.00 |

| Cat# | Description | 03/04/10/10B/10BE/26/26D/BSP/WSP |
|-------------|----------------------|---|
| SSL1 | SSL1 Auxiliary Latch | \$151.00 |

AL-2 AUXILIARY LOCKS

SARGENT®

480 DEADBOLTS

ASSA ABLOY

USA & Canada Prices Effective June 3, 2019

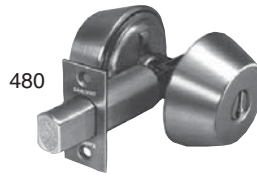

| 480 Series | | |
|------------|--|------------------|
| Options | Description | Price |
| 10 | SARGENT Signature System | Add \$58.00 /cyl |
| 11 | SARGENT XC Key System (not available with 10, 22, SC, SE options) | No addition |
| 1160 | Sargent XC Large Format Interchangeable Plastic Disposable Construction Core | No addition |
| 1163 | Sargent XC Large Format Interchangeable Core Cylinder - Includes masterkeying charges | \$77.00 |
| 1164 | Sargent XC Large Format Interchangeable Construction Core Cylinder | \$77.00 |
| 1170 | Small Format interchangeable disposable construction core - to accept 7 Pin XC permanent core | No Add |
| 11727P | Small Format interchangeable keyed construction core - to accept 7 Pin XC permanent core | \$69.00 |
| 11737P | Small Format interchangeable core - to accept 7 pin XC permanent core | \$69.00 |
| 16 | 400 "T" Shaped Strike 2-3/4" x 1-1/8" | Add \$2.00 |
| 20 | 2-3/8" Backset — 2-3/4" x 1" front | No addition |
| 21 | SARGENT Construction Key System (lost ball) Standard on all new systems est. 5/1/96 | Add \$16.00 /cyl |
| 22 | SARGENT Construction Key System (split key) To be used on pre-est. split key systems only | Add \$32.00 /cyl |
| 28 | 408 Flat Lip Strike 4-7/8" X 1-1/4" ANSI A115.2 | No addition |
| 36 | 6-Lobe security Head Screw | Add \$23.00 |
| 37 | Spanner Head Screw | Add \$16.00 |
| 48 | 488 Strike 3-5/8" x 1-1/4" | Add \$1.50 |
| 60 | SARGENT Large Format Interchangeable Plastic Disposable Construction Core | No addition |
| 63 | SARGENT Large Format Interchangeable Core Cylinder includes master and grandmaster keying charge | Add \$77.00 /cyl |
| 64 | SARGENT Large Format Interchangeable Construction Core Cylinder | \$77.00 |
| 6573 | Small Format 6-Pin Uncombined Core (Refer to CK-12) | Add \$59.00 /cyl |
| 65737P | Small Format 7-Pin Uncombined Core (Refer to CK-12) | Add \$59.00 /cyl |
| 70 | Small Format Interchangeable disposable plastic construction core | No Add |
| 72 | Small Format Interchangeable 6 pin construction core (7-pin with 11 option) | \$66.00 |
| 73 | Small Format interchangeable core 6-pin Includes MK and GMK keying charges | Add \$69.00 /cyl |
| 737P | Small Format interchangeable core 7-pin (refer to CK-12 for available keyways) Includes MK and GMK keying charges | Add \$69.00 /cyl |
| BR | SARGENT Bump Resistant Cyls. (N/A w/10, 22, 30, 60, 63, 64, 70, 72, 73, 737P, KESO, SC, SE) | Add \$23.00 /cyl |
| DG1 | Patented Degree DG1 Key System | No Addition |
| DG160 | Hardware prepared for DG1-6300 Lg. Format IC cores, supplied with temporary plastic construction cores | No addition |
| DG163 | Patented Degree DG1 Large Format Interchangeable Core Cylinder - Includes master keying charges | \$77.00 |
| DG164 | Hardware prepared for DG1-6300 Lg. Format IC cores, supplied with temporary keyed construction cores | \$77.00 |
| DG2 | Patented Degree DG2 Key System incorporating a locking sidebar | \$58.00/cyl. |
| DG260 | Hardware prepared for DG2-6300 Lg. Format IC cores, supplied with temporary plastic construction cores | No addition |
| DG263 | Patented Degree DG2 Large Format Interchangeable Core Cylinder - Includes master keying charges | \$135.00 |
| DG264 | Hardware prepared for DG2-6300 Lg. Format IC cores, supplied with temporary keyed construction cores | \$77.00 |
| DG3 | Patented Degree DG3 Key System incorporating a locking sidebar and UL437 listed | \$82.00/cyl. |
| DG360 | Hardware prepared for DG3-6300 Lg. Format IC cores, supplied with temporary plastic construction cores | No addition |
| DG363 | Patented Degree DG3 Large Format Interchangeable Core Cylinder - Includes master keying charges | \$159.00 |
| DG364 | Hardware prepared for DG3-6300 Lg. Format IC cores, supplied with temporary keyed construction cores | \$77.00 |
| LC | Less Cylinder | -\$87.00/cyl. |
| SC | Schlage "C" Keyway cylinder 0-Bitted | No Addition |
| SE | Schlage "E" Keyway cylinder 0-Bitted | No addition |

| 480 Series Bored Deadlock | | Finish | |
|---------------------------|-----------------|------------------|-----------------------------|
| Number | Description | 10BE/26D/BSP/WSP | 03/04/09 10/10B/14/15/26 |
| 484 | Double Cylinder | \$285.00 | \$292.00 |
| 485 | Single Cylinder | | |
| 486 | Single Cylinder | \$203.00 | \$210.00 |
| 487 | Classroom | | |
| 489 | Exit | \$173.00 | \$178.00 |

Note: Split finishes are available for 480's. Order outside/inside, price as higher price finish.

| 4870 Series | | |
|-------------|--|--------------------|
| Options | Description | Price |
| 10 | SARGENT Signature System | Add \$58.00 /cyl |
| 11 | SARGENT XC Key System (not available with 10, 22, SC, SE options) | No addition |
| 1160 | Sargent XC Large Format Interchangeable Plastic Disposable Construction Core | No addition |
| 1163 | Sargent XC Large Format Interchangeable Core Cylinder - Includes masterkeying charges | \$77.00 |
| 1164 | Sargent XC Large Format Interchangeable Construction Core Cylinder | \$77.00 |
| 1170 | Small Format interchangeable disposable construction core - to accept 7 Pin XC permanent core | No Add |
| 11727P | Small Format interchangeable keyed construction core - to accept 7 Pin XC permanent core | \$69.00 |
| 11737P | Small Format interchangeable core - to accept 7 pin XC permanent core | \$69.00 |
| 21 | SARGENT Construction Key System (lost ball) Standard on all new systems est. 5/1/96 | Add \$16.00 /cyl |
| 22 | SARGENT Construction Key System (split key) For pre-established split key systems only | Add \$32.00 /cyl |
| 28 | #7710 Strike 4-7/8" x 1-1/4" | No addition |
| 36 | 6-Lobe security Head Screw | Add \$23.00 |
| 37 | Spanner Head Screw | Add \$16.00 |
| 60 | SARGENT Large Format Interchangeable Plastic Disposable Construction Core | No addition |
| 63 | SARGENT Large Format IC Core Cylinder includes master and grandmaster keying charge | Add \$77.00 /cyl |
| 64 | SARGENT Large Format Interchangeable Construction Core Cylinder | \$77.00 |
| 6573 | Small Format 6-Pin Uncombined Core (Refer to CK-12) | Add \$59.00 /cyl |
| 65737P | Small Format 7-Pin Uncombined Core (Refer to CK-12) | Add \$59.00 /cyl |
| 70 | Small Format Interchangeable disposable plastic construction core | No Add |
| 72 | Small Format Interchangeable 6 pin construction core (7-pin with 11 option) | \$69.00 |
| 73 | Small Format Interchangeable 6-pin core (Includes MK and GMK keying charges) (refer to CK-8 for available keyways) | Add \$69.00 /cyl |
| 737P | Small Format Interchangeable 7-pin core (Includes MK and GMK keying charges) (refer to CK-8 for available keyways) | Add \$69.00 /cyl |
| 74 | Lock Case Wrapped in Lead | Add \$272.00 |
| 81 | Cylinders to accept KESO & KESO Removable Core – No core provided | No Add |
| F182 | SARGENT KESO Security Cylinder – Patent Pending | Add \$84.00 /cyl. |
| F183 | SARGENT KESO Security Removable Core Cylinder – Patent Pending | Add \$120.00 /cyl. |
| 82 | SARGENT KESO Security Cylinder (for existing systems only) | Add \$84.00 /cyl |
| 83 | SARGENT KESO Security Removable Core Cylinder (for existing systems only) | Add \$120.00 /cyl |
| 84 | SARGENT KESO Security Removable Construction Core Cylinder (for existing systems only) | See CK-18 |
| BR | SARGENT Bump Resistant Cyls. (N/A w/10, 22, 30, 60, 63, 64, 70, 72, 73, 737P, KESO, SC, & SE options) | Add \$23.00 /cyl. |
| DG1 | Patented Degree DG1 Key System | No Addition |
| DG160 | Hardware prepared for DG1-6300 Lg. Format IC cores, supplied with temporary plastic construction cores | No addition |
| DG163 | Patented Degree DG1 Large Format Interchangeable Core Cylinder - Includes master keying charges | \$77.00 |
| DG164 | Hardware prepared for DG1-6300 Lg. Format IC cores, supplied with temporary keyed construction cores | \$77.00 |
| DG2 | Patented Degree DG2 Key System incorporating a locking sidebar | \$58.00/cyl. |
| DG260 | Hardware prepared for DG2-6300 Lg. Format IC cores, supplied with temporary plastic construction cores | No addition |
| DG263 | Patented Degree DG2 Large Format Interchangeable Core Cylinder - Includes master keying charges | \$135.00 |
| DG264 | Hardware prepared for DG2-6300 Lg. Format IC cores, supplied with temporary keyed construction cores | \$77.00 |
| DG3 | Patented Degree DG3 Key System incorporating a locking sidebar and UL437 listed | \$82.00/cyl. |
| DG360 | Hardware prepared for DG3-6300 Lg. Format IC cores, supplied with temporary plastic construction cores | No addition |
| DG363 | Patented Degree DG3 Large Format Interchangeable Core Cylinder - Includes master keying charges | \$159.00 |
| DG364 | Hardware prepared for DG3-6300 Lg. Format IC cores, supplied with temporary keyed construction cores | \$77.00 |
| LB | Extra large thumbturn | \$16.00 |
| LC | Less Cylinder | -\$89.00/cyl. |
| SC | Schlage "C" Keyway cylinder, (#41 mortise cylinder only – 0-bitted) | No Addition |
| SE | Schlage "E" Keyway cylinder, (#41 mortise cylinder only – 0-bitted) | No addition |
| SG | MicroShield® – an antimicrobial powder coat finish | Add \$40.00 |
| WBS | Wrought Box Strike | No addition |

Note: All 4870 cylinders are shipped with #97 Rosette standard.
Split finishes are available. Order outside/inside, price as higher price finish.



4870

| 4870 Mortise Deadlock | | Finish | |
|-----------------------|---|------------------|--------------------------------------|
| Number | Description | 10BE/26D/BSP/WSP | 03/04/09/10/10B/10BL/15/20D/26/32/2D |
| 4874 | Double Cylinder | \$388.00 | \$394.00 |
| 4875 | Single Cylinder x Turn Lever | \$353.00 | \$358.00 |
| 4876 | Single Cylinder | \$297.00 | \$303.00 |
| 4877 | Classroom x Turn Lever | \$353.00 | \$358.00 |
| 4878 | Public Toilet (Double Cylinder) | \$443.00 | \$449.00 |
| 4879 | Exit | \$262.00 | \$268.00 |
| CPC | Clear Powder Coat over 26D/32D – How to order: 4875 x 32D x CPC All orders will continue to be handled as a "special" when CPC is required | | Add \$39.00 |

AL-4 AUXILIARY LOCKS

SARGENT®

STRIKES & PARTS

ASSA ABLOY

USA & Canada Prices Effective June 3, 2019

| 480/4870 Auxiliary Lock Strikes | | Finish | |
|--|--|---|-----------------------------------|
| Catalog # | Description | 10BE/26D/32D/BSP/WSP | 03/04/09/10/10B/10BL/26/32 |
| 400 | "T" Shaped Strike 2-3/4" x 1-1/8" - 480 Series (28-) | \$12.79 (32D only) | \$14.14 (03, 09, 10, 10B only) |
| 404 | Standard Strike - 480 Series | \$12.79 (32D only) | \$14.14 (03, 09, 10, 10B only) |
| 408 | Flat Lip Strike 4-7/8"x 1-1/4" - 480 Series (28-) | \$21.09 (32D only) | \$29.93 (03, 09, 10, 10B only) |
| 480 | Standard Strike - 4870 Series | \$12.79 | \$14.14 |
| 488 | 3-5/8" x 1-1/4" - 480 Series (48-) | \$28.58 (26D only) | \$34.01 (03, 09, 10, 10B only) |
| 7710 | Flat Lip Strike 4-7/8" x 1-1/4" - 4870 Series | \$21.09 | \$29.93 |
| 7730 | Optional Strike 4-7/8" x 1-1/4" - 4870 Series | \$21.09 | \$29.93 |
| 480 Deadbolt Assembly | | Finish | |
| Number | Description | 03/04/10/10B/10BE/32D/BSP/WSP | |
| *16-2149 | 2-3/4" Backset | \$66.71 | |
| *16-2153 | 2-3/8" Backset | \$66.71 | |
| Inside | | 10BE/26D/BSP/WSP | 03/04/10/10B/26 |
| *16-2177 | For 484 Function (Cylinder Housing—Specify if 70's options)) | \$45.05 | \$45.05 |
| *16-2039 | For 485 & 489 Function (Turn) | \$39.30 | \$39.30 |
| *16-2179 | For 487 Function (Turn) | \$27.39 | \$27.39 |
| 16-0301 | Mounting Plate 484, 485, 486, 487, 489 (inside and outside) | \$5.79 | \$5.79 |
| 16-0302 | Support Plate 485, 486, 487 & 489 | \$5.79 | \$5.79 |
| *16-0306 | For 486 Function (Blank Plate) | \$23.60 | \$23.60 |
| 16-2511 | Inside Cylinder Housing (484 with 60, 63, 64 option only) | \$38.33 | \$38.33 |
| *16-0326 | Collar (480 inside & outside – 60, 63, 64 option only) | \$74.47 | \$74.47 |
| *16-0329 | Face Plate | \$58.80 | \$58.80 |
| Outside | | 03/04/10/10B/10BE/26/26D/BSP/WSP | |
| 16-0301 | Mounting Plate 484, 485, 486, 487 | \$5.79 | |
| *16-2264 | Outside Cylinder Housing & Tailpiece Assy. (484) | \$64.14 | |
| *16-2265 | Outside Cylinder Housing & Tailpiece Assy. (485, 486, 487) | \$64.14 | |
| *16-0326 | Cylinder Housing Collar | \$74.47 | |
| *16-2193 | Screw Pack (48-484) | \$6.36 | |
| *16-2175 | Cylinder Housing Only for 484, 485, 486 & 487 | \$45.05 | |
| *16-2460 | Blank Rose—489 Function (after 10/98) | \$39.30 | |
| *16-2510 | Cylinder Housing Assy. (484 with 60-, 63-, 64- option only) | \$49.05 | |
| *16-2512 | Cylinder Housing Assy. (485, 487 with 60-, 63-, 64- option only) | \$49.05 | |
| *16-2513 | Cylinder Housing Assy. (486 with 60-, 63-, 64- option only) | \$49.05 | |
| 480 Screw Packs | | 32D | |
| *16-2201 | Double Cylinder Function 484 | | |
| *16-2202 | Single Cylinder Function 485, 486, 487 | \$7.76 | |
| *16-2203 | 489 Function (with cam bar after 10/98) | | |
| Parts | Description | Price | |
| 01-4446 | Cylinder Clamp Screw & Washer | \$0.50 | |
| 13-0880 | Tailpiece 1-3/8" – 1-3/4" Door (485/487) | \$1.94 | |
| 13-0878 | Tailpiece 1-3/4" Door (484) | \$1.94 | |
| 16-2508 | Cam assy.-cyl. prong for 60-, 63-, 64- options | \$3.64 | |
| 16-0277 | Strike Box | \$3.98 | |

*Specify Finish. Consult catalog for available finishes.

4870 MORTISE DEADBOLT PARTS

USA & Canada Prices Effective June 3, 2019

| Parts | | |
|------------------|-------------------------------|--------------|
| Catalog # | Description | Price |
| * 97 | Cylinder Collar includes ring | \$7.72 |
| * 130W | Turn Lever Pack | ML-113 |
| 01-0074 | Retaining Ring (hub) | \$0.97 |
| 01-0098 | Retaining Ring | \$0.97 |
| 01-0543 | Springrip Fastener | \$1.63 |
| * 01-1028 | Outside Front Screw | \$0.77 |
| 01-1142 | Case Screw | \$0.72 |
| * 01-2034 | #6 x 3/8" PH HD Wood Screw | \$0.85 |
| * 01-2035 | #6 x 1/2" PH HD Wood Screw | \$0.85 |
| * 01-3151 | #6-32 x 5/16" PH HD M.S. | \$1.20 |
| * 01-5000 | Inside Front Screw | \$0.81 |
| * 48-0042 | Outside Front | \$36.38 |
| * 48-2056 | Screw Pack for 4800 | \$12.07 |
| * 77-0137 | Plate | \$29.04 |
| 77-0772 | Spindle | \$7.60 |
| 77-0826 | Spindle | \$17.88 |
| * 77-2167 | Turn Lever Assembly. | \$29.40 |

*Specify hardware finish. Consult catalog for available finishes

AL-6 AUXILIARY LOCKS

SARGENT®

LOCKER & UTILITY LOCKS

ASSA ABLOY

USA & Canada Prices Effective June 3, 2019

| Option | Description | Price |
|--------|---|-------------|
| 21 | SARGENT Construction Key System (Lost ball) (Refer to CK-3 for additional masterkeying charges when using this option) | Add \$16.00 |

| Utility and Cabinet Locks | | Finish | | |
|---------------------------|--------------------------|------------------|-------------|------------|
| Number | | 10BE/26D/BSP/WSP | 03/04/10/26 | 10B/32/32D |
| 4142, 4143 | | \$113.00 | \$117.00 | \$124.00 |
| 13-0178 | Barrel (Plug)- US4 or 15 | \$29.65 | | |
| 13-0179 | Cam-nonhanded | \$29.57 | | |

| Prefix | Description | Price |
|--------|--|-------------|
| 10 | SARGENT Signature System | \$58.00 |
| 11 | SARGENT XC Key System | No addition |
| 21 | SARGENT Construction Key System (lost ball) Standard on new systems est. since 5/1/96 | \$16.00 |
| 22 | Construction Key System (split key) To be used on pre-established split key systems only | \$32.00 |

(Refer to CK-3 for additional masterkeying charges when using this prefix)

| Locker Locks | | Finish |
|--------------|--|----------|
| Number | | 04/26D |
| 1655 | | \$144.00 |

| Parts | Description | Price |
|---------|---------------------------|---------|
| C1655-1 | Cylinder & tailpiece assy | \$87.00 |
| 13-1813 | Tailpiece | \$6.47 |

| 758 Padlock | | |
|--------------------|--|------------------|
| Options | Description | Price |
| 10 | SARGENT Signature System | Add \$58.00 /cyl |
| * 11 | SARGENT XC Key System (not available with 10, 22, SC, SE options) | No addition |
| 1160 | Sargent XC Large Format Interchangeable Plastic Disposable Construction Core | No addition |
| 1163 | Sargent XC Large Format Interchangeable Core Cylinder - Includes masterkeying charges | \$77.00 |
| 1164 | Sargent XC Large Format Interchangeable Construction Core Cylinder | \$77.00 |
| * 21 | SARGENT Construction Key System (lost ball) Standard on all new systems est. since 5/1/96 | Add \$16.00 /cyl |
| * 22 | SARGENT Construction Key System (split key) To be used on pre-est. split key systems only | Add \$32.00 /cyl |
| * 51 | SARGENT Old Style Removable Core | Add \$78.00 /cyl |
| * 52 | SARGENT Old Style Construction Removable Core | \$77.00 |
| 60 | SARGENT Large Format Interchangeable Plastic Disposable Construction Core | No addition |
| 63 | SARGENT Large Format IC Core Cylinder includes master and grandmaster keying charge | Add \$77.00 /cyl |
| 64 | SARGENT Large Format Interchangeable Construction Core Cylinder | \$77.00 |
| BR | SARGENT Bump Resistant Cyls. (N/A w/10, 22, 30, 60, 63, 64, 70, 72, 73, 737P, KESO, SC, & SE prefixes) | \$23.00 |
| DG1 | Patented Degree DG1 Key System | No Addition |
| DG160 | Hardware prepared for DG1-6300 Lg. Format IC cores, supplied with temporary plastic construction cores | No addition |
| DG163 | Patented Degree DG1 Large Format Interchangeable Core Cylinder - Includes master keying charges | \$77.00 |
| DG164 | Hardware prepared for DG1-6300 Lg. Format IC cores, supplied with temporary keyed construction cores | \$77.00 |
| DG2 | Patented Degree DG2 Key System incorporating a locking sidebar | \$58.00/cyl. |
| DG260 | Hardware prepared for DG2-6300 Lg. Format IC cores, supplied with temporary plastic construction cores | No addition |
| DG263 | Patented Degree DG2 Large Format Interchangeable Core Cylinder - Includes master keying charges | \$135.00 |
| DG264 | Hardware prepared for DG2-6300 Lg. Format IC cores, supplied with temporary keyed construction cores | \$77.00 |
| DG3 | Patented Degree DG3 Key System incorporating a locking sidebar and UL437 listed | \$82.00/cyl. |
| DG360 | Hardware prepared for DG3-6300 Lg. Format IC cores, supplied with temporary plastic construction cores | No addition |
| DG363 | Patented Degree DG3 Large Format Interchangeable Core Cylinder - Includes master keying charges | \$159.00 |
| DG364 | Hardware prepared for DG3-6300 Lg. Format IC cores, supplied with temporary keyed construction cores | \$77.00 |
| LC | Less Cylinder | -\$21.00/cyl. |
| SC | Schlage "C" Keyway Cylinder - O Bitted | No Addition |
| SE | Schlage "E" Keyway Cylinder - O Bitted | No addition |

* Refer to CK-3 for additional master keying charges when using this option

| Padlock | | |
|--|-----------------------|----------|
| Number | Description | Price |
| 758 | Key Retaining Padlock | \$126.00 |
| Shackle Types and Suffixes | | |
| Heights: 1"-Standard , 2" (-2 suffix), & 4" (-4 suffix) | | N/C |
| Material: Stainless Steel-Standard , Hardened Steel-Optional specify (-HS suffix) | | N/C |
| Chain specify -C suffix | | \$2.00 |

| Removable Core Only For No. 63-758 Padlock | | |
|---|------------------------------------|---------|
| Number | Description | Price |
| 6300 | SARGENT Removable Core | \$77.00 |
| 65-6300 | SARGENT Removable Core Unassembled | \$67.00 |

| KESO Padlocks | | |
|-----------------------------|--|----------------|
| KESO F1 (Patented) Padlocks | | See page CK-21 |
| KESO Padlocks | | See page CK-26 |

| Parts | Description | Price |
|-----------|---|----------|
| 13-1230 | Standard Cylinder Tailpiece | \$1.87 |
| 13-1231 | Tailpiece for use with 63 or 60 option + Padlock | \$3.86 |
| C750-1 | 758/858 Cylinder & Tailpiece Assembly | \$87.00 |
| 10 C750-1 | 758/858 Cylinder & Tailpiece Assembly (10 option) | \$145.00 |
| 17-2006 | Chain & Clevis Assembly | \$25.46 |
| 17-2633 | 758/858 Cylinder Retainer & Screw Pack | \$14.13 |

AL-8 AUXILIARY LOCKS

SARGENT®

PADLOCK-858

ASSA ABLOY

USA & Canada Prices Effective June 3, 2019

| 858 Padlock | | |
|--------------------|--|------------------|
| Option | Description | Price |
| 10 | SARGENT Signature System | Add \$58.00 /cyl |
| *11 | SARGENT XC Key System (not available with 10, 22, SC, SE options) | No addition |
| 1160 | Sargent XC Large Format Interchangeable Plastic Disposable Construction Core | No addition |
| 1163 | Sargent XC Large Format Interchangeable Core Cylinder - Includes masterkeying charges | \$77.00 |
| 1164 | Sargent XC Large Format Interchangeable Construction Core Cylinder | \$77.00 |
| *21 | SARGENT Construction Key System (lost ball) Standard on all new systems est. since 5/1/96 | Add \$16.00 /cyl |
| *22 | SARGENT Construction Key System (split key) To be used on pre-est. split key systems only | Add \$32.00 /cyl |
| *51 | SARGENT Old Style Removable Core | Add \$78.00 /cyl |
| *52 | SARGENT Old Style Construction Removable Core | \$77.00 |
| 60 | SARGENT Large Format Interchangeable Plastic Disposable Construction Core | No addition |
| 63 | SARGENT Large Format IC Core Cylinder includes master and grandmaster keying charge | Add \$77.00 /cyl |
| 64 | SARGENT Large Format Interchangeable Construction Core Cylinder | \$77.00 |
| DG1 | Patented Degree DG1 Key System | No Addition |
| DG160 | Hardware prepared for DG1-6300 Lg. Format IC cores, supplied with temporary plastic construction cores | No addition |
| DG163 | Patented Degree DG1 Large Format Interchangeable Core Cylinder - Includes master keying charges | \$77.00 |
| DG164 | Hardware prepared for DG1-6300 Lg. Format IC cores, supplied with temporary keyed construction cores | \$77.00 |
| DG2 | Patented Degree DG2 Key System incorporating a locking sidebar | \$58.00/cyl. |
| DG260 | Hardware prepared for DG2-6300 Lg. Format IC cores, supplied with temporary plastic construction cores | No addition |
| DG263 | Patented Degree DG2 Large Format Interchangeable Core Cylinder - Includes master keying charges | \$135.00 |
| DG264 | Hardware prepared for DG2-6300 Lg. Format IC cores, supplied with temporary keyed construction cores | \$77.00 |
| DG3 | Patented Degree DG3 Key System incorporating a locking sidebar and UL437 listed | \$82.00/cyl. |
| DG360 | Hardware prepared for DG3-6300 Lg. Format IC cores, supplied with temporary plastic construction cores | No addition |
| DG363 | Patented Degree DG3 Large Format Interchangeable Core Cylinder - Includes master keying charges | \$159.00 |
| DG364 | Hardware prepared for DG3-6300 Lg. Format IC cores, supplied with temporary keyed construction cores | \$77.00 |
| LC | Less Cylinder | -\$21.00/cyl. |
| SC | Schlage "C" Keyway Cylinder - O Bitted | No Add |
| SE | Schlage "E" Keyway Cylinder - O Bitted | No Add |

* Refer to CK-3 for additional master keying charges when using this option

| Padlock | | |
|---|---------------------------|----------|
| Number | | Price |
| 858 | Non Key retaining Padlock | \$119.00 |
| Shackle Types and Suffixes | | |
| Heights: 1"-Standard, 2" (-2 suffix), & 4" (-4 suffix) | | N/C |
| Material: Stainless – Standard, Optional Hardened Steel (HS suffix) | | N/C |
| Chain specify -C suffix | | \$2.00 |

| Cylinders & Parts | | | |
|------------------------------|---------|--|----------|
| Option | Number | Description | Price |
| | 6300 | SARGENT Removable Core | \$77.00 |
| 65 | 6300 | SARGENT Removable Core Unassembled | \$67.00 |
| 10-21 | C750-1 | Standard 6 pin cylinder and tail piece with Signature & construction keying (10, 21 options) | \$177.00 |
| 21 | C750-1 | Standard 6 pin cylinder and tail piece assy. But (construction keying) 21 option lost ball | \$119.00 |
| | C750-1 | 758/858 Cylinder & Tailpiece Assembly | \$87.00 |
| SE | C750-1 | Standard 6 pin cylinder and tail pice with Schlage E keyway (0-bitted) | \$87.00 |
| SC | C750-1 | Standard 6 pin cylinder and tail pice with Schlage C keyway (0-bitted) | \$87.00 |
| 10 | C750-1 | Standard 6 pin cylinder and tail piece with Signature Feature (10 option) | \$145.00 |
| | 01-9219 | 858 Cylinder retainer screw | \$5.26 |
| | 13-1230 | Tail piece only for standard cylinder, 10- and 21- cylinders | \$1.87 |
| | 17-2633 | 858 Cylinder Retainer & Screw Pack | \$14.13 |
| | 17-2006 | 9 inch chain (C suffix when ordering complete padlock) optional | \$25.46 |

SPECIALTY HARDWARE

| | |
|---|-------|
| HP Series Tubular Lock with Push/Pull (ALP) Trim & Options... | SP-1 |
| 114/115 Series with Push/Pull Trim & Options | SP-2 |
| 114/115 Push/Pull Parts..... | SP-3 |
| 8200 Series PUSH/PULL Trim (ALP) Options | SP-4 |
| 8200 Series PUSH/PULL Trim (ALP) | SP-5 |
| 8200 Series Behavioral Health Trim (BHL) Options | SP-6 |
| 8200 Series Behavioral Health Trim (BHL)..... | SP-7 |
| 8200 Series Behavioral Health Trim (BHW) Options | SP-8 |
| 8200 Series Behavioral Health Trim (BHW) | SP-9 |
| 7800 Series Push/Pull Trim(PT) Options | SP-10 |
| 7800 Series Push/Pull Trim(PT)..... | SP-11 |
| 7800 Series Knob Trim(BHD) Options..... | SP-12 |
| 7800 Series Knob Trim(BHD) | SP-13 |
| 7800 Series (BHD) Inside Trim, Outside Trim | SP-14 |

HP SERIES TUBULAR LOCK WITH PUSH/PULL (ALP) TRIM & OPTIONS

USA & Canada Prices Effective June 3, 2019

How to order:

SG-HPU65 x ALP x 32D x RHR

| | |
|----------|-------|
| Option | SG |
| Function | HPU65 |
| Trim | ALP |
| Finish | 32D |

Specify hand when ordering
15 function is field reversible



ALP

| Options | Description | Price |
|---------|--|-------------|
| 14 | 505 Full Lip Strike | No addition |
| 24 | 2-3/4" Backset | No addition |
| 26 | 7" Backset | \$6.00 |
| 28 | 4-7/8" (124mm) ANSI curved lip strike #808 | No addition |
| 31 | 1-3/4" to 2-1/4" door thick door – only centered in door | No addition |
| 36 | 6 Lobe security head screws | \$23.00 |
| 37 | Spanner head screws | \$16.00 |
| 74 | Lead lined (Specify Push or Pull side) | \$239.00 |
| P- | Push/Pull – Field installed | \$23.00 |
| SG | MicroShield® an antimicrobial powder coat finish | \$40.00 |
| WBS | Wrought Box Strike | No Addition |
| CPC | Clear Powder Coat | \$62.00 |

| Function | Description | Finish 32D |
|----------|-------------|---------------|
| HPU15 | Passage | \$452.00 |
| HPU65 | Privacy | \$587.00 |

SP-2 SPECIALTY HARDWARE

SARGENT®

114/115 SERIES PUSH/PULL TRIM & OPTIONS

ASSA ABLOY

USA & Canada Prices Effective June 3, 2019



114 Push-Pull

Specify LH or LHR or RH or RHR

| Options | Description | Price |
|---------|--|-------------|
| 24 | 2-3/4" Backset | No addition |
| 26 | 7" Backset | \$6.00 |
| 28 | ANSI Strike #808 | No addition |
| 36 | 6-Lobe Security Head Screws | \$23.00 |
| 37 | Spanner Head Screws | \$16.00 |
| 74 | Lead lined (Specify Push or Pull side) | \$239.00 |
| P- | Engraved Paddles "Push" and "Pull" | \$23.00 |
| SG | MicroShield® an antimicrobial powder coat finish | \$40.00 |
| TB | Thru-bolt | \$30.65 |
| WBS | Wrought Box Strike | No Addition |

| Hospital Latch | | Finish | | |
|----------------|-------------|----------|----------|--------------|
| Number | Description | 10BE/26D | 10/26 | 03/04/15/10B |
| 114 | 5" Backset | | | |
| 115 | 5" Backset | \$466.00 | \$483.00 | \$568.00 |

| Thru-Bolt Packs-114/115 | | Price |
|-------------------------|-----------------|------------------|
| 21-2223 (4/pack) | for 1-3/4" door | per pack \$30.65 |
| 21-2224 (4/pack) | for 2" door | per pack \$34.23 |
| 21-2225 (4/pack) | for 2-1/4" door | per pack \$37.66 |

Note: Thru-Bolts are not standard with hospital latches. Please specify x thru-bolts, if required.

CPC Clear Powder Coat over 26D – How to order: 115 x 26D x LH x CPC Add \$62.00
 All orders will continue to be handled as a "special" when CPC is required

114/115 SERIES PUSH/PULL PARTS

USA & Canada Prices Effective June 3, 2019

| 114 | 115 | Part # | Description | Price |
|-----|-----|----------|-------------------------------------|------------------|
| X | X | 01-0697 | Spiral Pin | \$0.97 |
| X | X | 01-0997 | Spiral Pin (After 11/6/92) | \$0.70 |
| X | X | 01-1153 | Active Adjusting Screw | \$2.87 |
| X | X | *21-0156 | Cover (plain) | \$90.46 |
| X | X | 21-0214 | Cam Screw | \$5.75 |
| | X | 21-0246 | Bumper | \$2.87 |
| X | X | 21-0249 | Main Pivot | \$5.75 |
| | X | *21-0306 | Cover (push) | \$104.28 |
| X | X | *21-0307 | Cover (pull) | \$104.28 |
| X | | 21-0460 | Spring | \$6.76 |
| X | | 21-0461 | Cam (push) | \$28.19 |
| X | | 21-0462 | Cam (pull) | \$28.19 |
| X | | 21-0465 | Pin (spring) | \$2.37 |
| X | | *21-0468 | Cover (push) | \$104.28 |
| X | X | 21-0510 | Chassis (push & pull) | \$196.48 |
| X | | *21-0514 | Pull Handle | \$182.95 |
| X | | *21-0515 | Push Handle | \$182.95 |
| | X | *21-0516 | Pull Handle | \$196.48 |
| | X | *21-0517 | Push Handle | \$196.48 |
| | X | 21-2039 | Cam & Spring Assembly | \$42.23 |
| | X | *21-2046 | LH Pull Handle Assembly. less cover | \$341.76 |
| | X | *21-2047 | RH Pull Handle Assembly. less cover | \$341.76 |
| X | X | 21-2055 | Screw Pack | \$20.57 |
| | X | *21-2058 | LH Push Handle Assembly. less cover | \$357.27 |
| | X | *21-2059 | RH Push Handle Assembly. less cover | \$357.27 |
| X | X | 21-2223 | Thrubolt Sleeve 1-3/4" Door | \$30.65 per pkg. |
| X | X | 21-2224 | Thrubolt Sleeve 2" Door | \$34.23 per pkg. |
| X | X | 21-2225 | Thrubolt Sleeve 2-1/4" Door | \$37.66 per pkg. |
| X | | *21-2333 | LH Push Handle Assembly. less cover | \$341.75 |
| X | | *21-2334 | RH Push Handle Assembly. less cover | \$341.75 |
| X | X | *21-2339 | Latch Assembly - 5" Backset | \$211.87 |
| X | X | *21-2340 | Latch Assembly - 7" Backset | \$225.68 |
| X | | *21-2343 | LH Pull Handle Assembly. less cover | \$341.76 |
| X | | *21-2344 | RH Pull Handle Assembly. less cover | \$341.76 |
| X | X | *21-2360 | Latch Assembly - 2-3/4" Backset | \$196.48 |
| | | 21-2381 | Fire Shield & Spacer Assembly | \$22.96 |
| | | 21-2383 | Fire Shield Pack | \$41.15 |

*Specify hardware finish. Consult catalog for available finishes.

OPTIONS

USA & Canada Prices Effective June 3, 2019

| Options | Description | Price |
|----------|--|--|
| 10▲ | SARGENT Signature Key System | \$58.00 / cyl. |
| 11†▲ | SARGENT XC Key System (not available with 10, 22, SC, SE options) | No addition |
| 1160 | SARGENT XC Large Format Interchangeable Plastic Disposable Construction Core | No addition |
| 1163 | SARGENT XC Large Format Interchangeable Core Cylinder - Includes masterkeying charges | \$77.00 |
| 1164 | SARGENT XC Large Format Interchangeable Construction Core Cylinder | \$77.00 |
| 1170 | Small Format interchangeable disposable construction core - to accept 7 Pin XC permanent core | No addition |
| 11727P | Small Format interchangeable keyed construction core - to accept 7 Pin XC permanent core | \$69.00 |
| 11737P | Small Format interchangeable core - to accept 7 pin XC permanent core | \$69.00/cyl. |
| 21▲† | SARGENT Construction Key System (lost ball) Standard on all new systems established since 5/1/96 | \$16.00 / cyl. |
| 22▲† | SARGENT Construction Key System (split key) To be used on pre-established split key systems only | \$32.00 / cyl. |
| 23 | Locksets with flat 4 7/8" ANSI strike | No addition |
| 31 | Thick Doors - Extended Lip Required - Specify Length C to E - Cylinders - IMPORTANT- See 8200 Push/Pull trim catalog option page for cylinder limitations - Below charges DO NOT include additional charges for special cylinder requirements Doors up to 2-1/4" thick - lock centered - IF PANNELED – must specify panel thickness & panel location (inside or outside) For example: Specify 1-3/4" door with panel (Side) on inside or outside For doors thicker than 2-1/4" - consult factory | No addition Non Keyed function \$50.00 Keyed function \$100.00 |
| 36 | 6 Lobe security head screws | \$23.00 |
| 37 | Spanner head screws | \$16.00 |
| 49 | Visual Status Indicator - Available with 30 & 37 functions | \$92.00 |
| 49 | Occupancy indicator with emergency release - Available with 65, 66, & 68 functions | \$92.00 |
| 50 | Secured indicator - Available with 24, 25, 26, 28,29, 30, 36, 37, 38, 39, 40, 41, 43, 45, 50, 51, 52, & 67 functions | \$62.00 |
| 60 | SARGENT Large Format Interchangeable Plastic Disposable Construction Core | No addition |
| 63 | SARGENT Large Format Interchangeable core cylinder, includes master keying charges | \$77.00 / cyl. |
| 64 | SARGENT Large Format Interchangeable Construction Core Cylinder | \$77.00 |
| 6573▲† | Small Format 6-Pin Uncombined Core (Refer to CK-12) | \$59.00 / cyl. |
| 65737P▲† | Small Format 7-Pin Uncombined Core (Refer to CK-12) | \$59.00 / cyl. |
| 70▲† | Small Format Interchangeable disposable plastic construction core | No addition |
| 72▲† | Small Format Interchangeable 6-pin construction core (7-pin with 11 option) | \$69.00 |
| 73▲† | Small Format interchangeable core 6-pin Includes MK and GMK keying charges | \$69.00 / cyl |
| 737P▲† | Small Format interchangeable core 7-pin (refer to CK-12 for available keyways) Includes MK and GMK keying charges | \$69.00 / cyl |
| 74* | Lead Lining or Wrapping | \$272.00 |
| 81▲† | Cylinder to accept Keso (83) and Keso F1 (F183) removable core – no core provided | No addition |
| F182† | SARGENT Keso Security Cylinder – patented – new key systems | \$84.00 / cyl. |
| F183▲† | SARGENT Keso Security Removable Core Cylinder – patented – new key systems | \$120.00 / cyl. |
| 82† | SARGENT Keso Security Cylinder (For existing systems only) | \$84.00 / cyl. |
| 83▲† | SARGENT Keso Security Removable Core Cylinder (For existing systems only) | \$120.00 / cyl. |
| 84▲† | SARGENT Keso Security Removable Construction Core Cylinder | See CK-18 |
| BR | SARGENT Bump Resistant Cylinders (N/A w/10, 22, 30, 60, 63, 64, 70, 72, 73, 737P, KESO, SC, & SE options) | \$23.00 /cyl. |
| DG1 | Patented Degree DG1 Key System | No Addition |
| DG160 | Hardware prepared for DG1-6300 Lg. Format IC cores, supplied with temporary plastic construction cores | No Addition |
| DG163 | Patented Degree DG1 Large Format Interchangeable Core Cylinder - Includes master keying charges | \$77.00 |
| DG164 | Hardware prepared for DG1-6300 Lg. Format IC cores, supplied with temporary keyed construction cores | \$77.00 |
| DG2 | Patented Degree DG2 Key System incorporating a locking sidebar | \$58.00/cyl. |
| DG260 | Hardware prepared for DG2-6300 Lg. Format IC cores, supplied with temporary plastic construction cores | No addition |
| DG263 | Patented Degree DG2 Large Format Interchangeable Core Cylinder - Includes master keying charges | \$135.00 |
| DG264 | Hardware prepared for DG2-6300 Lg. Format IC cores, supplied with temporary keyed construction cores | \$77.00 |
| DG3 | Patented Degree DG3 Key System incorporating a locking sidebar and UL437 listed | \$82.00/cyl. |
| DG360 | Hardware prepared for DG3-6300 Lg. Format IC cores, supplied with temporary plastic construction cores | No addition |
| DG363 | Patented Degree DG3 Large Format Interchangeable Core Cylinder - Includes master keying charges | \$159.00 |
| DG364 | Hardware prepared for DG3-6300 Lg. Format IC cores, supplied with temporary keyed construction cores | \$77.00 |
| LC | Less Cylinder | -\$89.00/cyl. |
| OBS | Open Back Strike | \$73.00 |
| P- | Push/Pull – Field installed | \$23.00 |
| SC▲† | Schlage "C" Keyway cylinder, (Number 41 Cylinder Only, 0 bitted) | No addition |
| SE▲† | Schlage "E" Keyway cylinder, (Number 41 Cylinder Only, 0 bitted) | No addition |
| SG | MicroShield® – an antimicrobial powder coat finish | \$69.00 |
| WBS | Wrought Box Strike | No addition |

▲ Options not available with a standard 50 function lockout cylinder.
† Not available with 60, 63, 64 options

CPC Clear Powder Coat over 32D. All orders will continue to be handled as a "special" when CPC is ordered.

\$62.00



ALP

8200 SERIES PUSH/PULL TRIM (ALP)

USA & Canada Prices Effective June 3, 2019

| Function | | Finish |
|---|------------------------------------|------------|
| Single Cyl | | 32D |
| 8204 | Storeroom or Closet | |
| 8205 | Office or Entry | |
| 8237 | Classroom | \$1,153.00 |
| 8255 | Office or Entry | |
| 8206 | Storeroom or Service | |
| 8231 | Utility | |
| 8236 | Closet | \$1,173.00 |
| 8256 | Office or Inner Entry | |
| 8257, 8258, 8267 | Institutional Privacy | |
| Single Cyl With Deadbolt | | |
| 8224 | Room Door | |
| 8225 | Dormitory or Exit | |
| 8227 | Closet or Storeroom | |
| 8228, 8230 | Dummy Trim Deadlock | \$1,195.00 |
| 8235 | Storeroom | |
| 8243 | Apartment Corridor | |
| 8245 | Dormitory or Exit | |
| 8247 | Front Door or Apartment Corridor | |
| 8251 | Storeroom Deadbolt | |
| 8250 | Hotel Guest Lock | \$1,222.00 |
| Double Cyl No Deadbolt | | |
| 8216 | Apartment or Exit or Public Toilet | |
| 8217 | Asylum or Institutional | |
| 8238 | Classroom Security Intruder | \$1,240.00 |
| 8259 | School Security | |
| Double Cyl With Deadbolt | | |
| 8226 | Store Door | |
| 8229 | Dummy Trim Deadlock | |
| 8239, 8240 | Classroom Security Intruder | \$1,256.00 |
| 8241 | Classroom Security | |
| 8246 | Dormitory or Exit | |
| 8248 | Store Door | |
| 8249 | Security Deadbolt | |
| 8252 | Institutional | |
| Electro Mechanical Single Cyl – Specify 12V or 24V | | |
| 8270-12V/8270-24V | Fail Safe | \$1,349.00 |
| 8271-12V/8271-24V | Fail Secure | |
| Electro Mechanical Double Cyl – Specify 12V or 24V | | |
| 8272-12V/8272-24V | Fail Safe | \$1,406.00 |
| 8273-12V/8273-24V | Fail Secure | |
| Non Keyed | | |
| 8213 | Communication or Exit | \$1,014.00 |
| 8215 | Passage or Closet | |
| 8265 | Privacy Bedroom or Bath (Latch) | \$1,101.00 |
| 8266, 8268 | Privacy Bedroom or Bath (D.bolt) | \$1,132.00 |

LOCKBODIES ONLY - For ALP trim. For all other trimset lockbodies - refer to ML-93

| Part No. | Function | Price | Part No. | Function | Price |
|----------|------------------------------------|----------|----------|------------|----------|
| 82-4850 | 04, 05, 06, 13, 17, 31, 36, 37, 38 | \$386.00 | 82-4859 | 45, 46 | \$420.00 |
| 82-4851 | 15 | \$278.00 | 82-4860 | 47, 48 | \$420.00 |
| 82-4852 | 16 | \$386.00 | 82-4861 | 49 | \$420.00 |
| 82-4853 | 24, 26, 27, 68 | \$420.00 | 82-4862 | 50, 51, 52 | \$420.00 |
| 82-4854 | 25, 35, 39, 66 | \$420.00 | 82-4863 | 55 | \$386.00 |
| 82-4855 | 28, 29, 30 | \$420.00 | 82-4864 | 56 | \$402.00 |
| 82-4856 | 40 | \$420.00 | 82-4865 | 59 | \$386.00 |
| 82-4857 | 41 | \$420.00 | 82-4866 | 65 | \$337.00 |
| 82-4858 | 43 | \$420.00 | 82-4867 | 67 | \$402.00 |

8200 ALP Positive Pull Stop Kit (Includes inside and outside trims)

| Part# | Function | 32D |
|-------|---|---------|
| 684 | Positive Pull Stop Kit (Please specify handing) | \$34.00 |

8200 SERIES WITH BHL TRIM OPTIONS

USA & Canada Prices Effective June 3, 2019

| Options | Description | Price |
|----------|---|----------------------------|
| 10▲ | SARGENT Signature Key System | \$58.00 / cyl. |
| 11†▲ | SARGENT XC Key System (not available with 10, 22, SC, SE options) | No addition |
| 1160 | SARGENT XC Large Format Interchangeable Plastic Disposable Construction Core | No addition |
| 1163 | SARGENT XC Large Format Interchangeable Core Cylinder - Includes masterkeying charges | \$77.00 |
| 1164 | SARGENT XC Large Format Interchangeable Construction Core Cylinder | \$77.00 |
| 1170 | Small Format interchangeable disposable construction core - to accept 7 Pin XC permanent core | No addition |
| 11727P | Small Format interchangeable keyed construction core - to accept 7 Pin XC permanent core | \$69.00 |
| 11737P | Small Format interchangeable core - to accept 7 pin XC permanent core | \$69.00 / cyl. |
| 21▲† | SARGENT Construction Key System (lost ball) Standard on all new systems established since 5/1/96 | \$16.00 / cyl. |
| 22▲† | SARGENT Construction Key System (split key) To be used on pre-established split key systems only | \$32.00 / cyl. |
| 23 | Locksets with flat 4 7/8" ANSI strike | No addition |
| 31 | Thick Doors - Extended Lip Required - Specify Length C to E - Cylinders - IMPORTANT- See 8200 Push/Pull trim catalog option page for cylinder limitations - Below charges DO NOT include additional charges for special cylinder requirements Doors up to 2-1/4" thick - lock centered - IF PANNELED - must specify panel thickness & panel location (inside or outside) For example: Specify 1-3/4" door with panel (Side) on inside or outside | No addition |
| | | Non Keyed function \$50.00 |
| | | Keyed function \$100.00 |
| 37 | Spanner head screws | \$16.00 |
| 60 | SARGENT Large Format Interchangeable Plastic Disposable Construction Core | No addition |
| 63 | SARGENT Large Format Interchangeable core cylinder, includes master keying charges | \$77.00 / cyl. |
| 64 | SARGENT Large Format Interchangeable Construction Core Cylinder | \$77.00 |
| 6573▲† | Small Format 6-Pin Uncombined Core (Refer to CK-12) | \$59.00 / cyl. |
| 65737P▲† | Small Format 7-Pin Uncombined Core (Refer to CK-12) | \$59.00 / cyl. |
| 70▲† | Small Format Interchangeable disposable plastic construction core | No addition |
| 72▲† | Small Format Interchangeable 6-pin construction core (7-pin with 11 option) | \$69.00 |
| 73▲† | Small Format interchangeable core 6-pin Includes MK and GMK keying charges | \$69.00 / cyl |
| 737P▲† | Small Format interchangeable core 7-pin (refer to CK-12 for available keyways) Includes MK and GMK keying charges | \$69.00 / cyl |
| 74* | Lead Lining or Wrapping | \$272.00 |
| 81▲† | Cylinder to accept Keso (83) and Keso F1 (F183) removable core - no core provided | No addition |
| F182† | SARGENT Keso Security Cylinder - patented - new key systems | \$84.00 / cyl. |
| F183▲† | SARGENT Keso Security Removable Core Cylinder - patented - new key systems | \$120.00 / cyl. |
| 82† | SARGENT Keso Security Cylinder (For existing systems only) | \$84.00 / cyl. |
| 83▲† | SARGENT Keso Security Removable Core Cylinder (For existing systems only) | \$120.00 / cyl. |
| 84▲† | SARGENT Keso Security Removable Construction Core Cylinder | See CK-18 |
| BR | SARGENT Bump Resistant Cylinders (N/A w/10, 22, 30, 60, 63, 64, 70, 72, 73, 737P, KESO, SC, & SE options) | \$23.00 / cyl. |
| DG1 | Patented Degree DG1 Key System | No Addition |
| DG160 | Hardware prepared for DG1-6300 Lg. Format IC cores, supplied with temporary plastic construction cores | No addition |
| DG163 | Patented Degree DG1 Large Format Interchangeable Core Cylinder - Includes master keying charges | \$77.00 |
| DG164 | Hardware prepared for DG1-6300 Lg. Format IC cores, supplied with temporary keyed construction cores | \$77.00 |
| DG2 | Patented Degree DG2 Key System incorporating a locking sidebar | \$58.00/cyl. |
| DG260 | Hardware prepared for DG2-6300 Lg. Format IC cores, supplied with temporary plastic construction cores | No addition |
| DG263 | Patented Degree DG2 Large Format Interchangeable Core Cylinder - Includes master keying charges | \$135.00 |
| DG264 | Hardware prepared for DG2-6300 Lg. Format IC cores, supplied with temporary keyed construction cores | \$77.00 |
| DG3 | Patented Degree DG3 Key System incorporating a locking sidebar and UL437 listed | \$82.00/cyl. |
| DG360 | Hardware prepared for DG3-6300 Lg. Format IC cores, supplied with temporary plastic construction cores | No addition |
| DG363 | Patented Degree DG3 Large Format Interchangeable Core Cylinder - Includes master keying charges | \$159.00 |
| DG364 | Hardware prepared for DG3-6300 Lg. Format IC cores, supplied with temporary keyed construction cores | \$77.00 |
| DX | Deadbolt monitoring (not available with LX-) | \$182.00 |
| LC | Less Cylinder | -\$89.00/cyl. |
| LX | Latchbolt monitor | \$185.00 |
| OBS | Open Back Strike | \$73.00 |
| SC▲† | Schlage "C" Keyway cylinder, (Number 41 Cylinder Only, 0 bitted) | No addition |
| SE▲† | Schlage "E" Keyway cylinder, (Number 41 Cylinder Only, 0 bitted) | No addition |
| SG | MicroShield® - an antimicrobial powder coat finish | \$69.00 |
| WBS | Wrought Box Strike | No addition |

▲ Options not available with a standard 50 function lockout cylinder.

† Not available with 60, 63, 64 options

CPC Clear Powder Coat over 32D. All orders will continue to be handled as a "special" when CPC is ordered.

\$62.00

8200 SERIES WITH BHL TRIM



BHL

USA & Canada Prices Effective June 3, 2019

| Function | | Finish |
|---|------------------------------------|------------|
| Single Cyl | | 32D |
| 8204 | Storeroom or Closet | |
| 8205 | Office or Entry | \$1,757.00 |
| 8237 | Classroom | |
| 8256 | Office or Inner Entry | |
| 8257, 8258, 8267 | Institutional Privacy | \$1,782.00 |
| Single Cyl With Deadbolt | | |
| 8224 | Room Door | |
| 8225 | Dormitory or Exit | \$1,809.00 |
| 8227 | Closet or Storeroom | |
| Double Cyl No Deadbolt | | |
| 8216 | Apartment or Exit or Public Toilet | |
| 8217 | Asylum or Institutional | \$1,855.00 |
| 8238 | Classroom Security Intruder | |
| Double Cyl With Deadbolt | | |
| 8226 | Store Door | |
| 8239, 8240 | Classroom Security Intruder | \$1,875.00 |
| Electro Mechanical Single Cyl – Specify 12V or 24V | | |
| 8270-12V/8270-24V | Fail Safe | |
| 8271-12V/8271-24V | Fail Secure | \$1,953.00 |
| Electro Mechanical Double Cyl – Specify 12V or 24V | | |
| 8272-12V/8272-24V | Fail Safe | |
| 8273-12V/8273-24V | Fail Secure | \$2,010.00 |
| Non Keyed | | |
| 8215 | Passage or Closet | \$1,572.00 |
| 8265 | Privacy Bedroom or Bath (Latch) | \$1,650.00 |
| 8266 | Privacy Bedroom or Bath (Deadbolt) | \$1,734.00 |

LOCKBODIES ONLY - For BHL trim. For all other trimset lockbodies - refer to ML-93

| Part No. | Function | Price | Part No. | Function | Price |
|----------|--------------------|----------|----------|----------|----------|
| 82-3117 | 15 | \$304.00 | 82-5243 | 8270/71 | \$665.00 |
| 82-3121 | 16 | \$411.00 | 82-5247 | 8272/73 | \$665.00 |
| 82-3149 | 25, 39, 66 | \$444.00 | 82-3774 | 8240 | \$444.00 |
| 82-3153 | 24, 26, 27 | \$444.00 | 82-4273 | 8256 | \$428.00 |
| 82-3169 | 04, 05, 17, 37, 38 | \$411.00 | 82-4274 | 8267 | \$428.00 |
| 82-3185 | 65 | \$362.00 | | | |

**8200 SERIES BEHAVIORAL HEALTH
(BHW) TRIM OPTIONS**

USA & Canada Prices Effective June 3, 2019

| Options | Description | Price |
|----------|--|--|
| 10▲ | SARGENT Signature Key System | \$58.00 / cyl. |
| 11†▲ | SARGENT XC Key System (not available with 10, 22, SC, SE options) | No addition |
| 1160 | SARGENT XC Large Format Interchangeable Plastic Disposable Construction Core | No addition |
| 1163 | SARGENT XC Large Format Interchangeable Core Cylinder - Includes masterkeying charges | \$77.00 |
| 1164 | SARGENT XC Large Format Interchangeable Construction Core Cylinder | \$77.00 |
| 1170 | Small Format interchangeable disposable construction core - to accept 7 Pin XC permanent core | No addition |
| 11727P | Small Format interchangeable keyed construction core - to accept 7 Pin XC permanent core | \$69.00 |
| 11737P | Small Format interchangeable core - to accept 7 pin XC permanent core | \$69.00 /cyl. |
| 21▲† | SARGENT Construction Key System (lost ball) Standard on all new systems established since 5/1/96 | \$16.00 / cyl. |
| 22▲† | SARGENT Construction Key System (split key) To be used on pre-established split key systems only | \$32.00 / cyl. |
| 23 | Locksets with flat 4 7/8" ANSI strike | No addition |
| 31 | Thick Doors - Extended Lip Required - Specify Length C to E - Cylinders - IMPORTANT- See 8200 Push/Pull trim catalog option page for cylinder limitations - Below charges DO NOT include additional charges for special cylinder requirements Doors up to 2-1/4" thick - lock centered - IF PANNELED - must specify panel thickness & panel location (inside or outside) For example: Specify 1-3/4" door with panel (Side) on inside or outside For doors thicker than 2-1/4" - consult factory | No addition Non Keyed function \$50.00 Keyed function \$100.00 |
| 60 | SARGENT Large Format Interchangeable Plastic Disposable Construction Core | No addition |
| 63 | SARGENT Large Format Interchangeable core cylinder, includes master keying charges | \$77.00 / cyl. |
| 64 | SARGENT Large Format Interchangeable Construction Core Cylinder | \$77.00 |
| 6573▲† | Small Format 6-Pin Uncombined Core (Refer to CK-12) | \$59.00 / cyl. |
| 65737P▲† | Small Format 7-Pin Uncombined Core (Refer to CK-12) | \$59.00 / cyl. |
| 70▲† | Small Format Interchangeable disposable plastic construction core | No addition |
| 72▲† | Small Format Interchangeable 6-pin construction core (7-pin with 11 option) | \$69.00 |
| 73▲† | Small Format interchangeable core 6-pin Includes MK and GMK keying charges | \$69.00 / cyl |
| 737P▲† | Small Format interchangeable core 7-pin (refer to CK-12 for available keyways) Includes MK and GMK keying charges | \$69.00 / cyl |
| 74* | Lead Lining or Wrapping | \$272.00 |
| 81▲† | Cylinder to accept Keso (83) and Keso F1 (F183) removable core - no core provided | No addition |
| F182† | SARGENT Keso Security Cylinder - patented - new key systems | \$84.00 / cyl. |
| F183▲† | SARGENT Keso Security Removable Core Cylinder - patented - new key systems | \$120.00 / cyl. |
| 82† | SARGENT Keso Security Cylinder (For existing systems only) | \$84.00 / cyl. |
| 83▲† | SARGENT Keso Security Removable Core Cylinder (For existing systems only) | \$120.00 / cyl. |
| 84▲† | SARGENT Keso Security Removable Construction Core Cylinder | See CK-18 |
| BR | SARGENT Bump Resistant Cylinders (N/A w/10, 22, 30, 60, 63, 64, 70, 72, 73, 737P, KESO, SC, & SE options) | \$23.00 /cyl. |
| DG1 | Patented Degree DG1 Key System | No Addition |
| DG160 | Hardware prepared for DG1-6300 Lg. Format IC cores, supplied with temporary plastic construction cores | No addition |
| DG163 | Patented Degree DG1 Large Format Interchangeable Core Cylinder - Includes master keying charges | \$77.00 |
| DG164 | Hardware prepared for DG1-6300 Lg. Format IC cores, supplied with temporary keyed construction cores | \$77.00 |
| DG2 | Patented Degree DG2 Key System incorporating a locking sidebar | \$58.00/cyl. |
| DG260 | Hardware prepared for DG2-6300 Lg. Format IC cores, supplied with temporary plastic construction cores | No addition |
| DG263 | Patented Degree DG2 Large Format Interchangeable Core Cylinder - Includes master keying charges | \$135.00 |
| DG264 | Hardware prepared for DG2-6300 Lg. Format IC cores, supplied with temporary keyed construction cores | \$77.00 |
| DG3 | Patented Degree DG3 Key System incorporating a locking sidebar and UL437 listed | \$82.00/cyl. |
| DG360 | Hardware prepared for DG3-6300 Lg. Format IC cores, supplied with temporary plastic construction cores | No addition |
| DG363 | Patented Degree DG3 Large Format Interchangeable Core Cylinder - Includes master keying charges | \$159.00 |
| DG364 | Hardware prepared for DG3-6300 Lg. Format IC cores, supplied with temporary keyed construction cores | \$77.00 |
| DX | Deadbolt Monitoring (notavailable with 50, 74) | \$182.00 |
| LC | Less Cylinder | -\$89.00/cyl. |
| LX | Latchbolt Monitor - Monitors latchbolt position (not available with deadbolt functions) | \$185.00 |
| OBS | Open Back Strike | \$73.00 |
| RX | Request to Exit | \$190.00 |
| SC▲† | Schlage "C" Keyway cylinder, (Number 41 Cylinder Only, 0 bitted) | No addition |
| SE▲† | Schlage "E" Keyway cylinder, (Number 41 Cylinder Only, 0 bitted) | No addition |
| SG | MicroShield® - an antimicrobial powder coat finish | \$69.00 |
| WBS | Wrought Box Strike | No addition |

▲ Options not available with a standard 50 function lockout cylinder.

† Not available with 60, 63, 64 options

CPC Clear Powder Coat over 32D. All orders will continue to be handled as a "special" when CPC is ordered.

\$62.00



8200 SERIES BEHAVIORAL HEALTH TRIM (BHW)

BHW

USA & Canada Prices Effective June 3, 2019

| Function | | Finish |
|--|------------------------------------|------------|
| Single Cyl | | 32D |
| 8204 | Storeroom or Closet | |
| 8205 | Office or Entry | |
| 8237 | Classroom | \$1,816.00 |
| 8255 | Office or Entry | |
| 8256 | Office or Inner Entry | |
| 8257, 8258, 8267 | Institutional Privacy | \$1,839.00 |
| Single Cyl With Deadbolt | | |
| 8224 | Room Door | |
| 8225 | Dormitory or Exit | |
| 8227 | Closet or Storeroom | |
| 8228, 8230 | Dummy Trim Deadlock | \$1,863.00 |
| 8243 | Apartment Corridor | |
| 8245 | Dormitory or Exit | |
| 8247 | Front Door or Apartment Corridor | |
| 8251 | Storeroom Deadbolt | |
| 8250 | Hotel Guest Lock | \$1,895.00 |
| Double Cyl No Deadbolt | | |
| 8216 | Apartment or Exit or Public Toilet | |
| 8217 | Asylum or Institutional | |
| 8238 | Classroom Security Intruder | \$1,908.00 |
| 8259 | School Security | |
| Double Cyl With Deadbolt | | |
| 8226 | Store Door | |
| 8229 | Dummy Trim Deadlock | |
| 8239, 8240 | Classroom Security Intruder | \$1,915.00 |
| 8241 | Classroom Security | |
| 8246 | Dormitory or Exit | |
| 8248 | Store Door | |
| 8249 | Security Deadbolt | |
| 8252 | Institutional | |
| Electro Mechanical Single Cyl – Specify 12V or 24V | | |
| 8270-12V/8270-24V | Fail Safe | \$2,012.00 |
| 8271-12V/8271-24V | Fail Secure | |
| Electro Mechanical Double Cyl – Specify 12V or 24V | | |
| 8272-12V/8272-24V | Fail Safe | \$2,069.00 |
| 8273-12V/8273-24V | Fail Secure | |
| Non Keyed | | |
| 8215 | Passage or Closet | \$1,681.00 |
| 8265 | Privacy Bedroom or Bath (Latch) | \$1,738.00 |
| 8266, 8268 | Privacy Bedroom or Bath (D.bolt) | \$1,800.00 |

Note: Lockbodies only for BHW trim, refer to page ML-93

| 8200 BHW Trim Kits (Includes inside and outside trims) | | |
|--|--|------------|
| Part# | Function | 32D |
| 694-1 BHW | 15, 65, 66, 68 | \$1,126.00 |
| 694-2 BHW | 04, 05, 24, 25, 27, 28, 30, 37, 43, 45, 47, 50, 51, 55, 56, 67, 70, 71 | \$1,302.00 |
| 694-3 BHW | 16, 17, 26, 29, 38, 39, 40, 41, 46, 48, 49, 52, 59, 72, 73 | \$1,267.00 |

SP-10 SPECIALTY HARDWARE

SARGENT®

OPTIONS

ASSA ABLOY

USA & Canada Prices Effective June 3, 2019

| Options | Description | Price |
|----------|---|-----------------|
| 10 | SARGENT Signature Key System | \$58.00 / cyl. |
| 11†▲ | SARGENT XC Key System (not available with 10, 22, SC, SE options) | No addition |
| 1160 | SARGENT XC Large Format Interchangeable Plastic Disposable Construction Core | No addition |
| 1163 | SARGENT XC Large Format Interchangeable Core Cylinder - Includes masterkeying charges | \$77.00 |
| 1164 | SARGENT XC Large Format Interchangeable Construction Core Cylinder | \$77.00 |
| 1170 | Small Format interchangeable disposable construction core - to accept 7 Pin XC permanent core | No addition |
| 11727P | Small Format interchangeable keyed construction core - to accept 7 Pin XC permanent core | \$69.00 |
| 11737P | Small Format interchangeable core - to accept 7 pin XC permanent core | \$69.00 / cyl. |
| 21▲† | SARGENT Construction Key System (lost ball) Standard on all new systems established since 5/1/96 | \$16.00 / cyl. |
| 22▲† | SARGENT Construction Key System (split key) To be used on pre-established split key systems only | \$32.00 / cyl. |
| 23 | Locksets with flat 4-7/8" ANSI strike | No addition |
| 37 | Spanner head screws | \$16.00 |
| 60 | SARGENT Large Format Interchangeable Plastic Disposable Construction Core | No addition |
| 63 | SARGENT Large Format Interchangeable core cylinder, includes master keying charges | \$77.00 / cyl. |
| 64 | SARGENT Large Format Interchangeable Construction Core Cylinder | \$77.00 |
| 6573▲† | Small Format 6-Pin Uncombined Core (Refer to CK-12) | \$59.00 / cyl. |
| 65737P▲† | Small Format 7-Pin Uncombined Core (Refer to CK-12) | \$59.00 / cyl. |
| 70▲† | Small Format Interchangeable disposable plastic construction core | No addition |
| 72▲† | Small Format Interchangeable 6-pin construction core (7-pin with 11 option) | \$69.00 |
| 73▲† | Small Format interchangeable core 6-pin Includes MK and GMK keying charges | \$69.00 / cyl |
| 737P▲† | Small Format interchangeable core 7-pin (refer to CK-12 for available keyways) Includes MK and GMK keying charges | \$69.00 / cyl |
| 74 | Lock case wrapped in lead – handling required | \$272.00 |
| 81▲† | Cylinder to accept Keso (83) and Keso F1 (F183) removable core – no core provided | No addition |
| F182† | SARGENT Keso Security Cylinder – patented – new key systems | \$84.00 / cyl. |
| F183▲† | SARGENT Keso Security Removable Core Cylinder – patented – new key systems | \$120.00 / cyl. |
| 82† | SARGENT Keso Security Cylinder (For existing systems only) | \$84.00 / cyl. |
| 83▲† | SARGENT Keso Security Removable Core Cylinder (For existing systems only) | \$120.00 / cyl. |
| 84▲† | SARGENT Keso Security Removable Construction Core Cylinder | See CK-18 |
| BR | SARGENT Bump Resistant Cylinders (N/A w/10, 22, 30, 60, 63, 64, 70, 72, 73, 737P, KESO, SC, & SE options) | \$23.00 /cyl. |
| DG1 | Patented Degree DG1 Key System | No Addition |
| DG160 | Hardware prepared for DG1-6300 Lg. Format IC cores, supplied with temporary plastic construction cores | No addition |
| DG163 | Patented Degree DG1 Large Format Interchangeable Core Cylinder - Includes master keying charges | \$77.00 |
| DG164 | Hardware prepared for DG1-6300 Lg. Format IC cores, supplied with temporary keyed construction cores | \$77.00 |
| DG2 | Patented Degree DG2 Key System incorporating a locking sidebar | \$58.00/cyl. |
| DG260 | Hardware prepared for DG2-6300 Lg. Format IC cores, supplied with temporary plastic construction cores | No addition |
| DG263 | Patented Degree DG2 Large Format Interchangeable Core Cylinder - Includes master keying charges | \$135.00 |
| DG264 | Hardware prepared for DG2-6300 Lg. Format IC cores, supplied with temporary keyed construction cores | \$77.00 |
| DG3 | Patented Degree DG3 Key System incorporating a locking sidebar and UL437 listed | \$82.00/cyl. |
| DG360 | Hardware prepared for DG3-6300 Lg. Format IC cores, supplied with temporary plastic construction cores | No addition |
| DG363 | Patented Degree DG3 Large Format Interchangeable Core Cylinder - Includes master keying charges | \$159.00 |
| DG364 | Hardware prepared for DG3-6300 Lg. Format IC cores, supplied with temporary keyed construction cores | \$77.00 |
| LC | Less Cylinder | -\$89.00/cyl. |
| OBS | Open Back Strike | \$73.00 |
| SC▲† | Schlage "C" Keyway cylinder, (Number 41 Cylinder Only, 0 bitted) | No addition |
| SE▲† | Schlage "E" Keyway cylinder, (Number 41 Cylinder Only, 0 bitted) | No addition |
| SG | MicroShield® – an antimicrobial powder coat finish | \$69.00 |
| WBS | Wrought Box Strike | No addition |

▲ Options not available with standard 50 function lockout cylinder.

† Not available with 60, 63, 64 options.

7800 SERIES PUSH/PULL TRIM (PT)



7837 PT

USA & Canada Prices Effective June 3, 2019

| Function Single Cyl | | Finish | |
|---------------------------------|------------------------------------|------------|-----------------------------|
| | | 10BE/32D | 03/04/09/10/10B/10BL/20D/32 |
| 7804 | Storeroom or Closet | | |
| 7837 | Classroom | \$1,266.00 | \$1,290.00 |
| Single Cyl With Deadbolt | | | |
| 7824 | Room Door | | |
| 7843 | Apartment Corridor | \$1,312.00 | \$1,336.00 |
| 7845 | Dormitory or Exit | | |
| 7850 | Hotel Guest Lock | \$1,342.00 | \$1,366.00 |
| Double Cyl No Deadbolt | | | |
| 7816 | Apartment or Exit or Public Toilet | \$1,361.00 | \$1,385.00 |
| 7817 | Asylum or Institutional | | |
| Double Cyl With Deadbolt | | | |
| 7826 | Store Door | \$1,379.00 | \$1,403.00 |
| Non Keyed | | | |
| 7815 | Passage or Closet | \$1,108.00 | \$1,132.00 |
| 7865 | Privacy Bedroom or Bath (Latch) | \$1,205.00 | \$1,229.00 |

Note: All locks supplied standard with 4 each 6-lobe security head screws on escutcheons only.

| LOCKBODIES ONLY - For "PT" trim. For all other trimset lockbodies, refer to ML-93. | | | |
|--|----------|---|----------|
| Part # | Function | | Price |
| 78-2814 | 04 | Storeroom - Single Cylinder | |
| 78-2820 | 37 | Classroom - Single Cylinder | \$296.00 |
| 78-2818 | 24 | Storeroom - Single Cylinder w/deadbolt | |
| 78-2821 | 43 | Dwelling Entry - Single Cylinder w/deadbolt | \$326.00 |
| 78-2822 | 45 | Dwelling Entry - Single Cylinder w/deadbolt | |
| 78-2823 | 50 | Hotel - Single Cylinder w/Deadbolt | \$326.00 |
| 78-2816 | 16 | Public Entry - Double Cylinder | |
| 78-2817 | 17 | Asylum - Double Cylinder | \$296.00 |
| 78-2819 | 26 | Storeroom - Double Cylinder w/Deadbolt | \$326.00 |
| 78-2815 | 15 | Passage - Non-Keyed | \$192.00 |
| 78-2824 | 65 | Privacy - Non-Keyed | \$258.00 |

Note: Outside Fronts, Strikes, Cylinders and Trim are NOT included with lockbody. Please order separately.

| Inside and Outside Trim Sets | | | |
|------------------------------|------|----------|-----------------------------|
| Lock Function | Trim | 10BE/32D | 03/04/09/10/10B/10BL/20D/32 |
| IS-7804 IS-7837 | PT | \$599.00 | \$628.00 |
| IS-7815 | | | |
| IS-7816 IS-7817 IS-7826 | PT | \$612.00 | \$639.00 |
| IS-7824 IS-7843 IS-7850 | | | |
| IS-7825 IS-7845 IS-7865 | PT | \$636.00 | \$668.00 |
| Lock Function | Trim | 10BE/32D | 03/04/09/10/10B/10BL/20D/32 |
| OS-7804 OS-7824 OS-7843 | | | |
| OS-7816 OS-7826 OS-7845 | PT | \$628.00 | \$660.00 |
| OS-7817 OS-7837 OS-7850 | | | |
| OS-7815 | PT | \$622.00 | \$694.00 |
| OS-7865 | PT | \$646.00 | \$675.00 |

Note: Must specify "Push" or "Pull" when ordering.

**7800 SERIES BEHAVIORAL HEALTH
KNOB TRIM (BHD) OPTIONS**

USA & Canada Prices Effective June 3, 2019

| Options | Description | Price |
|----------|--|--|
| 1▲ | 7800 Line with 1-1/16" wide front for 1-3/8" doors. | \$58.00 |
| 10▲ | SARGENT Signature Key System | \$58.00 / cyl. |
| 11†▲ | SARGENT XC Key System (not available with 10, 22, SC, SE options) | No addition |
| 1160 | SARGENT XC Large Format Interchangeable Plastic Disposable Construction Core | No addition |
| 1163 | SARGENT XC Large Format Interchangeable Core Cylinder - Includes masterkeying charges | \$77.00 |
| 1164 | SARGENT XC Large Format Interchangeable Construction Core Cylinder | \$77.00 |
| 1170 | Small Format interchangeable disposable construction core - to accept 7 Pin XC permanent core | No addition |
| 11727P | Small Format interchangeable keyed construction core - to accept 7 Pin XC permanent core | \$69.00 |
| 11737P | Small Format interchangeable core - to accept 7 pin XC permanent core | \$69.00 / cyl. |
| 21▲† | SARGENT Construction Key System (lost ball) Standard on all new systems established since 5/1/96 | \$16.00 / cyl. |
| 22▲† | SARGENT Construction Key System (split key) To be used on pre-established split key systems only | \$32.00 / cyl. |
| 23 | Locksets with flat 4-7/8" ANSI strike | No addition |
| 31 | Thick Doors - Extended Lip Required - Specify Length C to E - Cylinders - IMPORTANT- See catalog 7800/8200 option page for cylinder limitations - Below charges DO NOT include additional charges for special cylinder requirements Doors up to 2-1/2" thick - lock centered Doors 2-5/8" to 6" thick OR doors 1-3/4" thick w/max 1" paneling one side. For example: Specify 1-3/4" door with panel (Side) on inside or outside | No addition Non Keyed function \$50.00 Keyed function \$100.00 |
| 36 | 6 Lobe security head screws | \$23.00 |
| 37 | Spanner head screws | \$16.00 |
| 60 | SARGENT Large Format Interchangeable Plastic Disposable Construction Core | No addition |
| 63 | SARGENT Large Format Interchangeable core cylinder, includes master keying charges | \$77.00 / cyl. |
| 64 | SARGENT Large Format Interchangeable Construction Core Cylinder | \$77.00 |
| 6573▲† | Small Format 6-Pin Uncombined Core (Refer to CK-12) | \$59.00 / cyl. |
| 65737P▲† | Small Format 7-Pin Uncombined Core (Refer to CK-12) | \$59.00 / cyl. |
| 70▲† | Small Format Interchangeable disposable plastic construction core | No addition |
| 72▲† | Small Format Interchangeable 6-pin construction core (7-pin with 11 option) | \$69.00 |
| 73▲† | Small Format interchangeable core 6-pin Includes MK and GMK keying charges | \$69.00 / cyl |
| 737P▲† | Small Format interchangeable core 7-pin (refer to CK-12 for available keyways) Includes MK and GMK keying charges | \$69.00 / cyl |
| 74 | Lock case wrapped in lead - handing required (roses not available) | \$272.00 |
| 81▲† | Cylinder to accept Keso (83) and Keso F1 (F183) removable core - no core provided | No addition |
| F182† | SARGENT Keso Security Cylinder - patented - new key systems | \$84.00 / cyl. |
| F183▲† | SARGENT Keso Security Removable Core Cylinder - patented - new key systems | \$120.00 / cyl. |
| 82† | SARGENT Keso Security Cylinder (For existing systems only) | \$84.00 / cyl. |
| 83▲† | SARGENT Keso Security Removable Core Cylinder (For existing systems only) | \$120.00 / cyl. |
| 84▲† | SARGENT Keso Security Removable Construction Core Cylinder | See CK-18 |
| AV | Anti Vandal Pull Trim (available in 32D finish) | \$212.00 |
| BR | SARGENT Bump Resistant Cylinders (N/A w/10, 22, 30, 60, 63, 64, 70, 72, 73, 737P, KESO, SC, & SE options) | \$23.00 /cyl. |
| DG1 | Patented Degree DG1 Key System | No Addition |
| DG160 | Hardware prepared for DG1-6300 Lg. Format IC cores, supplied with temporary plastic construction cores | No addition |
| DG163 | Patented Degree DG1 Large Format Interchangeable Core Cylinder - Includes master keying charges | \$77.00 |
| DG164 | Hardware prepared for DG1-6300 Lg. Format IC cores, supplied with temporary keyed construction cores | \$77.00 |
| DG2 | Patented Degree DG2 Key System incorporating a locking sidebar | \$58.00/cyl. |
| DG260 | Hardware prepared for DG2-6300 Lg. Format IC cores, supplied with temporary plastic construction cores | No addition |
| DG263 | Patented Degree DG2 Large Format Interchangeable Core Cylinder - Includes master keying charges | \$135.00 |
| DG264 | Hardware prepared for DG2-6300 Lg. Format IC cores, supplied with temporary keyed construction cores | \$77.00 |
| DG3 | Patented Degree DG3 Key System incorporating a locking sidebar and UL437 listed | \$82.00/cyl. |
| DG360 | Hardware prepared for DG3-6300 Lg. Format IC cores, supplied with temporary plastic construction cores | No addition |
| DG363 | Patented Degree DG3 Large Format Interchangeable Core Cylinder - Includes master keying charges | \$159.00 |
| DG364 | Hardware prepared for DG3-6300 Lg. Format IC cores, supplied with temporary keyed construction cores | \$77.00 |
| DX | Deadbolt Monitoring (not available with 50, 74) | \$182.00 |
| LC | Less Cylinder | -\$89.00/cyl. |
| OBS | Open Back Strike | \$73.00 |
| SC▲† | Schlage "C" Keyway cylinder, (Number 41 Cylinder Only, 0-bitted) | No addition |
| SE▲† | Schlage "E" Keyway cylinder, (Number 41 Cylinder Only, 0-bitted) | No addition |
| SG | MicroShield® - an antimicrobial powder coat finish | \$67.00 |
| WBS | Wrought Box Strike | No addition |

NOTES

▲ Options not available with standard 50 function lockout cylinder.

† Not available with 60, 63, 64 options.

CPC Clear Powder Coat 32D - 7805 x BHD x RH x 32D x CPC \$62.00
All orders will continue to be handled as a "special" when CPC is ordered.

7800 SERIES BEHAVIORAL HEALTH KNOB TRIM (BHD)



BHD

USA & Canada Prices Effective June 3, 2019

NOTE: Not ADA Compliant.

| Function | | Finish |
|---------------------------------|------------------------------------|------------|
| Single Cyl | | 32D |
| 7804 | Storeroom or Closet | |
| 7805 | Office or Entry | |
| 7837 | Classroom | \$1,889.00 |
| 7855 | Office or Entry | |
| 7806 | Storeroom or Service | |
| 7831 | Utility | |
| 7836 | Closet | \$1,909.00 |
| 7856 | Office or Inner Entry | |
| 7867 | Institutional Privacy | |
| Single Cyl With Deadbolt | | |
| 7824 | Room Door | |
| 7825 | Dormitory or Exit | |
| 7827 | Closet or Storeroom | |
| 7828, 7830 | Dummy Trim Deadlock | \$1,934.00 |
| 7835 | Storeroom | |
| 7843 | Apartment Corridor | |
| 7845 | Dormitory or Exit | |
| 7847 | Front Door or Apartment Corridor | |
| 7851 | Storeroom Deadbolt | |
| 7850 | Hotel Guest Lock | \$1,970.00 |
| Double Cyl No Deadbolt | | |
| 7816 | Apartment or Exit or Public Toilet | |
| 7817 | Asylum or Institutional | \$1,979.00 |
| 7838 | Classroom Security Intruder | |
| Double Cyl With Deadbolt | | |
| 7826 | Store Door | |
| 7829 | Dummy Trim Deadlock | |
| 7839, 7840 | Classroom Security Intruder | |
| 7841 | Classroom Security | \$2,000.00 |
| 7846 | Dormitory or Exit | |
| 7848 | Store Door | |
| 7852 | Institutional | |
| Non Keyed | | |
| 7813 | Communication or Exit | \$1,739.00 |
| 7815 | Passage or Closet | |
| 7865 | Privacy Bedroom or Bath (Latch) | \$1,835.00 |
| 7866, 7868 | Privacy Bedroom or Bath (Deadbolt) | \$1,867.00 |
| 7893 | Single Dummy Trim | \$786.00 |
| 7894 | Double Dummy Trim | \$1,574.00 |
| 7895 | Single Dummy Trim w/Lockbody | \$877.00 |
| 7896 | Double Dummy Trim w/Lockbody | \$1,659.00 |
| 7897 | Double Dummy w/Active Trim | \$1,739.00 |

SP-14 SPECIALTY HARDWARE

SARGENT®

7800 SERIES (BHD) INSIDE, OUTSIDE TRIM, AND MISCELLANEOUS PARTS

ASSA ABLOY

USA & Canada Prices Effective June 3, 2019

Example: IS-7825 BHD x 32D x RH

Inside trim sets include: Inside knob, inside rose or escutcheon, trim pack (spindles, thru-bolt screws, set screws, inside adaptor plate assembly), trim finish screws. CYLINDERS NOT INCLUDED – Order separately.

| Lock Function | Trim | 32D |
|---------------------------------|------|----------|
| IS-7804 IS-7815 IS-7867 | | |
| IS-7805 IS-7837 IS-7895 | BHD | \$691.00 |
| IS-7806 IS-7855 IS-7896 | | |
| IS-7813 IS-7856 IS-7897 | | |
| IS-7816 IS-7838 IS-7846 | | |
| IS-7817 IS-7839 IS-7848 | BHD | \$697.00 |
| IS-7826 IS-7840 IS-7852 | | |
| IS-7829 IS-7841 IS-7892 | | |
| IS-7824 IS-7830 IS-7850 IS-7868 | | |
| IS-7825 IS-7843 IS-7851 | BHD | \$719.00 |
| IS-7827 IS-7845 IS-7865 | | |
| IS-7828 IS-7847 IS-7866 | | |
| Lock Function | Trim | 32D |
| OS-7804 OS-7829 OS-7841 OS-7855 | | |
| OS-7805 OS-7830 OS-7843 OS-7856 | | |
| OS-7816 OS-7831 OS-7845 OS-7867 | | |
| OS-7817 OS-7835 OS-7846 | | |
| OS-7824 OS-7836 OS-7847 | BHD | \$743.00 |
| OS-7825 OS-7837 OS-7848 | | |
| OS-7826 OS-7838 OS-7850 | | |
| OS-7827 OS-7839 OS-7851 | | |
| OS-7828 OS-7840 OS-7852 | | |
| OS-7815 OS-7894 OS-7896 OS-7897 | BHD | \$720.00 |
| OS-7865 OS-7866 OS-7868 | BHD | \$746.00 |

Electrical

| | |
|-------------------------------------|------|
| Electro-Mechanical Locksets..... | EL-1 |
| Electro-Mechanical Exit Device..... | EL-2 |
| ElectroLynx Retrofit Kits..... | EL-3 |

Electronic Accessories

| | |
|---|------|
| Switches/Keypads/Push Buttons..... | EL-4 |
| Wall Switches, Electrical Accessories/ Power Supplies & Battery Backup | EL-5 |
| Monitoring Accessories/Key Switches | EL-6 |
| Electromagnetic Locks | EL-7 |

Alarms - 5100/5800

| | |
|-----------------------------------|------|
| Exit Alarms 5100/5800 Series..... | EL-8 |
|-----------------------------------|------|

Fire Guard Door Closers

| | |
|---|-------|
| Electromechanical 351EHT/EHT DCloser-Holder Release Device | EL-9 |
| Fire Guard Closers 2409 Series | EL-9 |
| Fire Guard Closers 2900 Series | EL-10 |

Parts

| | |
|---------------------------|-------|
| 01-0997 thru 63-3056..... | EL-11 |
| 63-3057 thru 82-3618..... | EL-12 |

USA & Canada Prices Effective June 3, 2019



| 10 Line Electrical Options | | Price |
|----------------------------|---------------------------------|----------|
| RX | Request to exit or enter switch | \$190.00 |

Function
Key - in - Lever Bored Series

| | | |
|---------------------|-------------------------------|---------------------------------------|
| 10G70-12V/10G70-24V | Single Cylinder - Fail Safe | Price as listed on page BL-17, 19, 21 |
| 10G71-12V/10G71-24V | Single Cylinder - Fail Secure | |

Mortise Electrical Lock Option

| | | |
|----|---------------------------------------|-----------------------------------|
| RX | Request to exit or enter switch | List Price \$190.00 Add |
| DX | Deadbolt Monitoring | List Price \$182.00 Add |
| LX | Latchbolt Monitor | List Price \$185.00 Add |
| TL | SARGuide™ – Illuminated WT Escutcheon | List Price \$214.00 Add |

Mortise Lever Series – Specify 12v or 24v

| | |
|---------------------|-------------------------------|
| 8270-12v / 8270-24v | Single Cylinder - Fail Safe |
| 8271-12v / 8271-24v | Single Cylinder - Fail Secure |
| 8272-12v / 8272-24v | Double Cylinder - Fail Safe |
| 8273-12v / 8273-24v | Double Cylinder - Fail Secure |
| 9270-12v / 9270-24v | Single Cylinder - Fail Safe |
| 9271-12v / 9271-24v | Single Cylinder - Fail Secure |
| 9272-12v / 9272-24v | Double Cylinder - Fail Safe |
| 9273-12v / 9273-24v | Double Cylinder - Fail Secure |

Refer to Mortise Lock section for pricing

Electro-Mechanical Locksets are available in all Finishes and Designs as listed on the standard product series price pages referenced above.

ELECTRO-MECHANICAL EXIT DEVICES

USA & Canada Prices Effective June 3, 2019

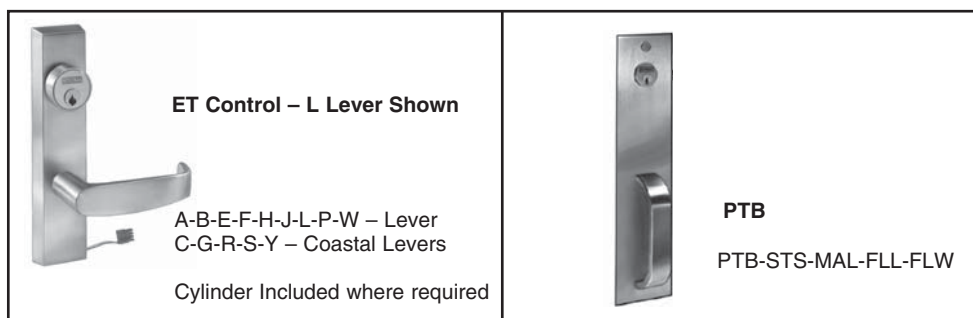

| Series | ET Control Lever Designs: | Pull Designs |
|--|--|-----------------------|
| 80 Series = Pushbar Type Exit Device | A, B, E, F, J, L, P, W | PTB, FLL, STS, |
| 90 Series = Crossbar Type Exit Device | C, G, R, S, Y - Coastal Designs | FLW, MAL |
| 8373, 8973 | Mortise | Fail Safe |
| 8374, 8974 | Mortise | Fail Secure |
| 8375, 8975, 9975 | Mortise | Fail Safe |
| 8376, 8976, 9976 | Mortise | Fail Secure |
| AD8473, MD8473 | Concealed | Fail Safe |
| AD8474, MD8474 | Vertical Rod | Fail Secure |
| AD8573 | Rim | Fail Safe |
| AD8574 | Rim | Fail Secure |
| AD8673, MD8673, WD8673, SP8673, PP8673, PR8673, LS8673, LP8673, LR8673 | Concealed | Fail Safe |
| MD8674, WD8674, SP8674, PP8674, PR8674, LS8674, LP8674, LR8674 | Vertical Rod | Fail Secure |
| 8773, NB8773, SP8773, PP8773, PR8773, 9773 | Surface | Fail Safe |
| 8774, NB8774, SP8774, PP8774, PR8774, 9774 | Vertical Rod | Fail Secure |
| FM8773 | Concealed | Fail Safe |
| FM8774 | Vertical Rod | Fail Secure |
| 8873 | Rim | Fail Safe |
| 8874 | Rim | Fail Secure |
| 8875, 9875 | Rim | Fail Safe |
| 8876, 9876 | Rim | Fail Secure |
| 700 Series ET Lever Trim Only | Function | |
| 773 Control | Fail Safe | |
| 774 Control | Fail Secure | |
| 775 Control | Fail Safe | |
| 776 Control | Fail Secure | |

Refer to Exit Device section for pricing.

Note: 73 and 74 functions are Non-cylinder functions.
773 and 774 ET trims are Non-cylinder trims.
ET Trim supplied in 26D finish in lieu of 32D.

| Electronic Exit Device - refer to ED-4 thru ED-44 for pricing w/Exit Device and restrictions | | |
|---|--|----------------|
| Option | Description | Price |
| 53 | Latchbolt Monitor Switch | Add \$237.00 |
| 54 | Internal Micro Switch for ET Control | Add \$214.00 |
| 55 | Signal Switch in Rail | Add \$223.00 |
| 56 | Remote Dogging/Latch Retraction | Add \$835.00 |
| 57 | Delayed Action - order magnet separate | Add \$1,302.00 |
| 58 | Electric Dogging | Add \$450.00 |
| 59 | Electroguard (Cylinder provided in rail) | Add \$1,593.00 |
| BC59 | Electroguard Boca Code (Cylinder provided in rail) | Add \$1,695.00 |
| AL | Exit Alarm | Add \$550.00 |
| TL | SARGuide™ - Illuminated Touchpad | Add \$214.00 |
| PL | SARGuide™ PL - Photoluminescent Coating | Add \$348.00 |

RETROFIT KITS & WIRING DIAGRAM SERVICES

USA & Canada Prices Effective June 3, 2019

ElectroLynx - Retrofit Kits

| | How to Order: | Price |
|---|---------------|----------|
| Retro 3 R/Way CBL-2Wire | 52-2945 | \$15.41 |
| Retro TL-3 R/Way CBL-2Wire | 52-2979 | \$9.12 |
| 53- 3 R/Way CBL-3 Wire | 52-2980 | \$10.75 |
| 55- 3 R/Way CBL-3 Wire | 52-2981 | \$10.75 |
| For Solenoid Only - 3' - QC2A - 2 Pin Connector w/2 wires | 52-2982 | \$33.42 |
| For Solenoid Only - 15' - QC2A - 2 Pin Connector w/2 wires | 52-2983 | \$39.78 |
| For TL option (SARGuide) - 3' - QC2A - 2 Pin Connector with 2 wires | 52-2984 | \$39.78 |
| For 59- Circuit Board & Harness Repl. Kit (F size rail) | 52-2994 | \$674.81 |
| For 59- Circuit Board & Harness Repl. Kit (J size rail) | 52-2995 | \$674.81 |
| For 59- Circuit Board & Harness Repl. Kit (G size rail) | 52-2996 | \$674.81 |
| For 57- Circuit Board & Harness Repl. Kit (F size rail) | 52-2997 | \$557.04 |
| For 57- Circuit Board & Harness Repl. Kit (J size rail) | 52-2998 | \$557.04 |
| For 57- Circuit Board & Harness Repl. Kit (G size rail) | 52-2999 | \$557.04 |
| 3 -4P E-Lynx Kit | 52-3450 | \$13.34 |
| Note: **56- using timer mode (and ED56) | | |
| **TL-56 (and ED56) | | |
| **59- all functions or latch bolt monitor and remote arm delay | | |
| **AL- when using 546 harness door status and remote reset wires | | |
| Terminal Female (AWG20-24) | 52-0361 | \$0.30 |
| Terminal Female (AWG 26-30) | 52-0362 | \$0.30 |
| Terminal Male (AWG20-24) | 52-0363 | \$0.30 |
| Terminal Male (AWG 26-30) | 52-0364 | \$0.30 |

Custom Wiring Diagrams Services:

| Catalog# | Description | Price |
|----------|--------------------------------|-------|
| WD-BASIC | Basic Riser/Elevation Diagrams | **** |
| WD-SPEC | Specification Package | **** |
| WD-P2P | Point to Point | **** |
| WD-SYSPK | System package | **** |
| WD-SWP | Special Wiring Package | **** |

****Consult the Electromechanical Technical Services Team @ 800-810-WIRE (9473) to establish the price, type & number of wiring diagrams required for your project.

USA & Canada Prices Effective June 3, 2019

| 855 Signal Switch Kit for 80 & 30 Series Exit Devices | | Price |
|--|-------------------|--------------|
| 855 | Signal Switch Kit | \$340.00 |

| Key Pads and Card Reader | | Price |
|---------------------------------|---|--------------|
| 4291 | Microprocessor Controller Keypad | \$506.00 |
| 4292 | Weatherproof Microprocessor Controlled Keypad | \$535.00 |
| 4301 | Card Reader | \$996.00 |

USA & Canada Prices Effective June 3, 2019

| Wall Switches | | Price |
|---------------|--|----------|
| 4397HP | Narrow type switch with handicap logo & push to operate door | \$235.00 |
| 4397HPRF | Narrow type switch with handicap logo & push to operate door & RF option | \$334.00 |
| 4396HP | 6" x 6" Square type wall switch with handicap logo & press to operate door | \$346.00 |
| 4396HPRF | 6" x 6" Square type wall switch with handicap logo & press to operate door & RF option | \$464.00 |
| 4396P | 6" x 6" Square type wall switch with press to open | \$339.00 |
| 4396PRF | 6" x 6" Square type wall switch with press to open & RF option | \$464.00 |
| 4395HP | 6" Round type wall switch with handicap logo & press to operate door | \$421.00 |
| 4395HPRF | 6" Round type wall switch with handicap logo & press to operate door & RF option | \$536.00 |
| 4395P | 6" Round type wall switch with press to open | \$421.00 |
| 4395PRF | 6" Round type wall switch with press to open & RF option | \$536.00 |
| 4341 | 1" x 3/4" Surface mount push button | \$103.00 |
| 4399 | 2" Square green push button | \$103.00 |

| Electrical Accessories | | Price |
|------------------------|--|---------|
| 546 | AL-Wiring Harness (For AL- option) - Mfg. prior to 7/1/04 | \$66.00 |
| 546-F | AL-Wiring Harness (For AL- option Exits F-Size Rail) - Mfg. after 7/1/04 | \$66.00 |
| 546-G | AL-Wiring Harness (For AL- option Exits G-Size Rail) - Mfg. after 7/1/04 | \$66.00 |
| 546-J | AL-Wiring Harness (For AL- option Exits J-Size Rail) - Mfg. after 7/1/04 | \$66.00 |
| 3261 | Armored Door Loop | \$66.00 |
| 3285 | Surface Actuator Switch | \$76.00 |
| 3287 | Concealed Actuator Switch | \$84.00 |
| 52-0171 | Magnetic Stripe Card Pack for 4301 Card Reader (25 each minimum) | \$6.00 |
| 4352 | Junction Box for 4292 | \$54.00 |

* Voice Modules provided with standard message "Emergency Exit Only". Door can be opened in 15 seconds.
For custom message, consult factory.

| Power Supplies | | Price |
|----------------|---------------------------------------|------------|
| 3267 | 9VDC Power Supply 700MA | \$510.00 |
| 3520 | 24VDC Regulated Power Supply 1 amp. | \$346.00 |
| 3521 | 12VDC Regulated Power Supply 1 amp. | \$346.00 |
| 3540 | 24VDC Regulated Power Supply 2 amp. | \$711.00 |
| 3541 | 12VDC Regulated Power Supply 3 amp. | \$711.00 |
| 3550 | 24VDC Regulated Power Supply 4 amp. | \$1,190.00 |
| 3551 | 12VDC Regulated Power Supply 4.5 amp. | \$1,177.00 |
| 3570 | 24VDC Regulated Power Supply 6 amp. | \$1,439.00 |
| 3571 | 12VDC Regulated Power Supply 6 amp. | \$1,204.00 |

| Battery Backup | | Price |
|----------------|-------------------------------|----------|
| TMR2 | Timer 0-255 minute time delay | \$219.00 |
| TMR9 | Timer 0-35 second time delay | \$109.00 |
| 737 | Battery - 12VDC - 4 amp. | \$81.00 |
| 738 | Battery - 24VDC - 4 amp. | \$183.00 |

USA & Canada Prices Effective June 3, 2019

| Monitoring Strike | | Price |
|--------------------------|----------------|--------------|
| 881 | Monitor Strike | \$274.00 |

| For Below Keyswitches | | |
|------------------------------|--|-------------------|
| Option | Description | Price |
| 10 | SARGENT Signature Key System | Add \$58.00 /cyl. |
| 11 | SARGENT XC Key System (not available with 10, 22, SC, SE options) | No addition |
| 1160 | SARGENT XC Large Format Interchangeable Plastic Disposable Construction Core | No addition |
| 1163 | SARGENT XC Large Format Interchangeable Core Cylinder - Includes masterkeying charges | \$77.00 |
| 1164 | SARGENT XC Large Format Interchangeable Construction Core Cylinder | \$77.00 |
| 21 | SARGENT Construction Key System (lost ball) Standard on all new systems | Add \$16.00 /cyl. |
| 22 | SARGENT Construction Key System (split key) to be used on pre-established split key systems only | Add \$32.00 /cyl. |
| 60 | SARGENT Large Format Interchangeable Plastic Disposable Construction Core | No addition |
| 63 | SARGENT Large Format IC Core Cylinder includes master and grandmaster keying charge | Add \$77.00 /cyl. |
| 64 | SARGENT Large Format Interchangeable Construction Core Cylinder | \$77.00 |
| F182 | SARGENT KESO Security, Patented, Cylinder | Add \$84.00 /cyl. |
| 82 | SARGENT KESO Security Cylinder | Add \$84.00 /cyl. |

| Keyswitch Number | | Price |
|-------------------------|---|--------------|
| 4370 | One SPDT maintained contact switch (replaces 4285) | \$421.00 |
| 4371 | One SPDT momentary contact switch | \$379.00 |
| 4372 | One DPDT maintained contact switch | \$487.00 |
| 4373 | One DPDT momentary contact switch | \$442.00 |
| 4374 | Two SPDT maintained contact switches | \$442.00 |
| 4375 | Two SPDT momentary contact switches (replaces 4281) | \$402.00 |
| 4376 | Two DPDT maintained contact switches | \$518.00 |
| 4377 | Two DPDT momentary contact switches | \$487.00 |
| 4378 | One SPDT momentary & one SPDT maintained contact switch | \$442.00 |
| 4379 | One DPDT momentary & one DPDT maintained contact switch | \$518.00 |
| 4380H | Single Gang-Horn ONLY | \$236.00 |
| 4380HL | Single Gang-Horn with LED's (green & red) | \$281.00 |

| Suffixes for Key Switches | | Price |
|----------------------------------|---------------------------------------|--------------|
| L | 2 LED's One-red, One-green | Add \$49.00 |
| H | 1 Horn 80dB | Add \$101.00 |
| T | Adjustable Time Delay (5-120 seconds) | Add \$292.00 |

Notes: H or T suffixes require a double gang box. Examples: 4371LH, 4378LH.
Horn and time delay combination is NOT available in the same keyswitch

ELECTROMAGNETIC LOCKS

USA & Canada Prices Effective June 3, 2019

| Electromagnetic Locks | | | Finish | |
|------------------------------|-------------|---|---------------|-----------------|
| | | | 32D | EB/ED/28 |
| 1584 | Single Door | Push Side | \$829.00 | - |
| 1584H | Single Door | Push Side (Includes dress cover) | - | \$870.00 |
| 1585 | Double Door | Push Side | \$1,658.00 | - |
| 1585J | Double Door | Push Side (Includes 18" wide dress cover) | - | \$1,745.00 |
| 1586 | Single Door | Pull Side | \$993.00 | \$993.00 |
| 1587 | Double Door | Pull Side | \$1,992.00 | \$1,992.00 |

| Accessories | | | EB/ED/28 |
|--------------------|-------------------------------|--|-----------------|
| Part Number | Description | | |
| 15-0078 | Single Dress Cover | | \$51.00 |
| 15-0079 | Double Dress Cover | | \$94.00 |
| 15-2107 | Header Extension Bracket | | \$94.00 |
| 15-2109 | 1/4" Stop Filler Plate | | \$28.00 |
| 15-2110 | 3/8" Stop Filler Plate | | \$28.00 |
| 15-2111 | 1/2" Stop Filler Plate | | \$28.00 |
| 15-2112 | 5/8" Stop Filler Plate | | \$28.00 |
| 15-2113 | Concrete/Wood Frame Bracket | | \$89.00 |
| 15-2114 | "Z" Bracket with Cover | | \$166.00 |
| | | | 32D |
| 15-2116 | Double Horizontal Housing | | \$854.00 |
| 15-2117 | Double Vertical Housing | | \$854.00 |
| 15-2118 | Single Horizontal Housing LHR | | \$426.00 |
| 15-2119 | Single Horizontal Housing RHR | | \$426.00 |

EXIT ALARMS 5100/5800 SERIES

USA & Canada Prices Effective June 3, 2019

| Exit Alarms 5100/5800 Series | | |
|------------------------------|---|---------|
| Option | Description | Price |
| 36 | 6 Lobe security head screws (5100) | \$24.00 |
| 36 | 6 Lobe security head screws (5800) | \$40.00 |
| 37 | Spanner head screws 5100) | \$16.00 |
| 37 | Spanner head screws (5800) | \$27.00 |
| 91 | Remote Power (Requires 3267 Power Supply) | \$36.00 |
| 92 | Remote Monitoring | \$47.00 |
| 93 | Continuous Alarm | \$36.00 |
| 94 | Automatic Re-Arm | \$36.00 |
| TB | Notes: Thru bolts not supplied standard. Add per bolt when ordered with device. Lever and Knob Trim supplied with 5100 and 5800 series furnished in 26D finish in lieu of 32D. All Alarmed Exit Hardware is priced with Cylinders where applicable. | \$6.00 |

| 5100 Series | | Finish | |
|-------------|--|-------------------|--------------------------------|
| Less Trim | | EN/EB/ EAB/ERD | 10/10B/10BE/ 26/26D/BSP/WSP |
| 5110 | | \$813.00 | \$846.00 |
| 5104 | | | |
| 5113 | | \$867.00 | \$905.00 |
| 5115 | | | |

| 5800 Series | | Finish | |
|-------------|-----------|-------------------|--------------------------------|
| Option | Catalog # | EN/EB/ EAB/ERD | 10/10B/10BE/ 32/32D/BSP/WSP |
| 5810 | | \$947.00 | \$1,254.00 |
| 5804 | | | |
| 5813 | | \$1,009.00 | \$1,314.00 |
| 5815 | | | |
| 12 | 5810 | \$1,124.00 | \$1,431.00 |
| 12 | 5804 | | |
| 12 | 5813 | \$1,186.00 | \$1,491.00 |
| 12 | 5815 | | |



| 5100/5800 Series Trim | | | Finish | |
|-----------------------|---------------------------|-------------|--------------------------|---|
| Option | Function | Description | EN/PEB/ EAB/ERD/ED/EP | 03/04/09/10/10B/10BE/ 10BL/15/26/26D/BSP/WSP |
| 28C | (13 Function) | LL, LB, LP | | |
| 28K | (04 Function) | LL, LB, LP | | |
| 28L | (15 Function) | LL, LB, LP | | \$354.00 |
| 28N | (06 Function) | LL, LB, LP | | |
| 28D | (10 Function) | LL, LB, LP | | |
| 28COB | (13 Function) | | | |
| 28KOB | (04 Function) | | | \$230.00 |
| 28LOB | (15 Function) | | | |
| 814GTB | (04 Function) | | \$197.00 | |
| 810GTB | (10 Function) | | \$100.00 | |
| 802GTB | (Blank Plate-10 Function) | | \$97.00 | |

ELECTROMECHANICAL 351EHT/EHTD FIRE GUARD CLOSERS 2409 SERIES

USA & Canada Prices Effective June 3, 2019

| Additional Features | | |
|---------------------|--|-------------|
| Option | Description | Price |
| 36 | Torx Security Screws | Add \$18.00 |
| DA | Delayed action | \$38.00 |
| MC | Metal Cover | \$16.00 |
| TB | Mortise Nuts when ordered w/Fire Guard | No addition |

| 351EHT/EHTD | | | Specify Finish when ordering: EB/ED/EN/EP/EAB |
|-------------|------|-------------------------------------|---|
| Catalog # | Arm | Description | Price |
| 351 | EHT | Single Point (Push or Pull) | \$1,071.00 |
| 351 | EHTD | Handed Single Point (Double Egress) | \$1,159.00 |

| Parts | Description | Price |
|-----------|---|--------------|
| * 351A | Mounting Plate | \$88.00 |
| * 351D | Drop Bracket | \$88.00 |
| * 351C | Plastic Cover | \$41.00 |
| * 63-0730 | Non-handed Metal Cover | \$50.53 |
| * 4TB | Mortise Nuts ordered separate (4 per set) | \$14.00 /Set |

2409 Series Single Point Hold Open

(All units require voltage)

| Smoke Detector Units | | | Finish |
|----------------------|-----------|--|-----------------|
| Option | Catalog # | Description | EB/ED/EN/EP/EAB |
| 12 | 2469 | Pull Side Mounting (Regular Arm) 120VAC, 24VAC/DC | \$2,088.00 |
| 12 | 2479 | Pull Side Mounting (Double Egress Arm) (RH or LH) 120VAC, 24VAC/DC | \$2,173.00 |
| 12 | 2499 | Push Side Mounting (Regular Arm) 120VAC, 24VAC/DC | \$2,088.00 |

| Option | Catalog # | Companion Units – used in conjunction with smoke detector units | Price |
|--------|-----------|---|------------|
| 9 | 2469 | Pull Side Mounting (Regular Arm) 24VDC ONLY | \$1,063.00 |
| 9 | 2479 | Pull Side Mounting (Double Egress Arm) (RH or LH) 24VDC ONLY | \$1,148.00 |
| 9 | 2499 | Push Side Mounting (Regular Arm) 24VDC ONLY | \$1,063.00 |

| Stand Alone Units | | | |
|-------------------|-----------|--|------------|
| Option | Catalog # | Description | Price |
| | 2469 | Pull Side Mounting (Regular Arm) 120VAC, 24VAC/DC | \$1,063.00 |
| | 2479 | Pull Side Mounting (Double Egress Arm) (RH or LH) 120VAC, 24VAC/DC | \$1,148.00 |
| | 2499 | Push Side Mounting (Regular Arm) 120VAC, 24VAC/DC | \$1,063.00 |

FIRE GUARD CLOSERS 2900 SERIES

USA & Canada Prices Effective June 3, 2019

| Additional Features | | | |
|--|--|---|---------------------|
| Option | Description | | Price |
| 80 | Adjustable By Pass Hold Open Switch – for 2960, 2970, or 2990- (Not available on 9- Units) | | \$90.00 |
| 2900 Series Multi Point Hold Open | | | |
| (All units require handing and voltage) | | | |
| Smoke Detector Units | | | Finish |
| Option | Catalog # | Description | EN/EB/EP/EAB |
| 12 | 2960 | Pull Side Mounting (Slide Arm - Rigid) (RH or LH) 120VAC, 24VAC/DC | \$2,527.00 |
| 12 | 2970 | Pull Side Mounting (Double Egress) (RH or LH) 120VAC, 24VAC/DC | \$2,559.00 |
| 12 | 2980 | Pull Side Mounting (Slide Arm - Swing Free) (RH or LH) 120VAC, 24VAC/DC | \$2,562.00 |
| Push Side Mounting (Regular Arm) (RH or LH) 120VAC, 24VAC/DC | | | |
| 12 | 2991 | Up to 1" reveals | |
| 12 | 2992 | From 1-1/8" - 4" reveals | \$2,500.00 |
| 12 | 2993 | From 4-1/8" - 7" reveals | |
| 12 | 2994 | From 4-1/8" - 7" reveals (OY Arm) (Heavy Duty) | |
| 12 | 2995 | From 7-1/8" - 8-5/8" reveals (OYA Arm) (Heavy Duty) | \$2,775.00 |
| Companion Units – used in conjunction with smoke detector units | | | |
| 9 | 2960 | Pull Side Mounting (Slide Arm - Rigid) (RH or LH) 24VDC ONLY | \$1,434.00 |
| 9 | 2970 | Pull Side Mounting (Double Egress) (RH or LH) 24VDC ONLY | \$1,466.00 |
| 9 | 2980 | Pull Side Mounting (Slide Arm - Swing Free) (RH or LH) 24VDC ONLY | \$1,469.00 |
| Push Side Mounting (Regular Arm) (RH or LH) 24VDC ONLY | | | |
| 9 | 2991 | Up to 1" reveals | |
| 9 | 2992 | From 1-1/8" - 4" reveals | \$1,407.00 |
| 9 | 2993 | From 4-1/8" - 7" reveals | |
| 9 | 2994 | From 4-1/8" - 7" reveals (OY Arm) (Heavy Duty) | |
| 9 | 2995 | From 7-1/8" - 8-5/8" reveals (OYA Arm) (Heavy Duty) | \$1,682.00 |
| Stand Alone Units | | | |
| | 2960 | Pull Side Mounting (Slide Arm - Rigid) (RH or LH) 120VAC, 24VAC/DC | \$1,434.00 |
| | 2970 | Pull Side Mounting (Double Egress) (RH or LH) 120VAC, 24VAC/DC | \$1,466.00 |
| | 2980 | Pull Side Mounting (Slide Arm - Swing Free) (RH or LH) 120VAC, 24VAC/DC | \$1,469.00 |
| Push Side Mounting (Regular Arm) (RH or LH) 120VAC, 24VAC/DC | | | |
| | 2991 | Up to 1" reveals | |
| | 2992 | From 1-1/8" - 4" reveals | \$1,407.00 |
| | 2993 | From 4-1/8" - 7" reveals | |
| | 2994 | From 4-1/8" - 7" reveals (OY Arm) (Heavy Duty) | |
| | 2995 | From 7-1/8" - 8-5/8" reveals (OYA Arm) (Heavy Duty) | \$1,682.00 |

*Please specify finish.

USA & Canada Prices Effective June 3, 2019

| Part No. | Price |
|--|----------|
| 01-0997 Slide Pin Ret. Ring | \$0.70 |
| * 01-1028 Flat Head Mach. Screw 8-32 x 1/4 | \$0.77 |
| * 01-1143 Flat Hd Mach. Screw 12-24 x 5/8" | \$0.89 |
| 01-1146 Flat Head Screw 8-32x3/8" | \$0.90 |
| 01-1190 Mounting Screw | \$1.68 |
| * 01-1206 Pan Head Mach Screw 8-32 x 5/16 | \$0.73 |
| 01-1463 Adjusting Rod Screw | \$1.96 |
| * 01-2298 Flat Hd Wood Screw 12 x 1" | \$0.73 |
| * 01-2303 Flat Hd Wood Screw 12 x 2 1/4" | \$1.94 |
| 01-2306 Flat Head Wood Screw 12 x 3" | \$1.93 |
| * 01-3438 Flat Hd Mach. Screw 12-24 x 1 3/4" | \$1.60 |
| 01-3440 Flat Head Mach Screw 12-24 x 2 1/4" | \$1.60 |
| * 01-4400 Flat Head Mach Screw 12-24 x 2 1/2" | \$1.62 |
| * 01-4401 Pan Head Mach Screw 12-24 x 3/4" | \$0.22 |
| 01-4411 Pan Head Screw 12-24 x 3/8" | \$0.63 |
| * 01-4412 Flat Head Mach Screw 12-24 x 5/8" | \$0.35 |
| 01-4414 Pan Head Screw 12-24 x 3/8" | \$0.32 |
| * 01-4471 Flat Head Self Tapping Screw 4-40 x 1/4" | \$0.21 |
| 01-7005 Diode (for 59-) | \$1.59 |
| 01-7011 Star Ring Terminal | \$0.73 |
| 01-7012 Self Adhesive Bumper | \$1.19 |
| 01-9036 3A-AC Fuse (3560) | \$7.01 |
| 01-9041 1.5A-AC Fuse (3510) | \$4.02 |
| 01-9042 1.8A In Line Fuse (3510) | \$5.88 |
| 01-9063 Washer | \$0.15 |
| 08-4687 Fail Secure Solenoid Assy. | \$571.74 |
| 08-4688 Fail Secure Solenoid Assy. | \$571.74 |
| CB-351 351/2408 1351EHT Closer Body | \$412.00 |
| CB-351DA351/2408 Closer Body w/Delayed Action | \$450.00 |
| 32-1093 Connector -2 Wire | \$3.24 |
| 32-1144 Emergency Decal (5800) | \$3.15 |
| 32-1190 Screw 4-4 Ounce x 1/4" | \$0.81 |
| 32-1272 Wire Mesh for 5100/5800 CVR | \$8.21 |
| 32-1364 1.5A-AC Fuse | \$8.67 |
| 32-7023 Magnet Pack (540/550) | \$27.30 |
| * 32-7033 5800 Cover Assy. w/Circuit Board | \$708.62 |
| * 32-7035 5810 Cover Assembly w/C-Board | \$708.62 |
| 32-7043 Battery Snap/Wire Assy. | \$5.24 |
| 32-7044 Tamper Switch & Bracket Assy 5100/5800 | \$85.76 |
| 32-7059 O/S Shutoff Switch Assy. | \$55.79 |
| * 32-7064 Cover Assembly | \$118.32 |
| 32-7067 Chassis Assy. (500-01 Series) | \$475.69 |
| 32-7070 5100/5800 Circuit Board w/Back Plate Assy | \$331.30 |
| 32-7097 Switch | \$37.28 |
| 32-7159 Chassis Assy. (5100) | \$351.46 |
| 32-7165 Remote Power/Monitor Connector (Alarms) | \$97.10 |
| * 32-7180 5100/5800 CVR/Wire Mesh Assy. | \$193.86 |
| 32-7184 Remote Power Connector | \$58.46 |
| 32-7185 Remote Monitor Connector | \$19.53 |
| * 32-7228 Misc. Pkg. A (5104/5110) | \$417.55 |
| * 32-7229 Misc. Pkg. B (5104/5110) | \$469.73 |
| * 32-7230 Misc. Pkg. C (5100) | \$68.61 |
| * 32-7231 Misc. Pkg. D (5115) | \$469.73 |
| 32-7232 Misc. Pkg. E (5804) | \$328.04 |
| 32-7233 Misc. Pkg. F (5804/5813) | \$369.06 |
| 32-7234 Misc. Pkg. G (5810) | \$298.26 |
| 32-7235 Misc. Pkg. H (5815) | \$372.82 |
| 32-7236 Misc. Pkg. I (5800/12-5800) | \$26.85 |
| 32-7237 Misc. Pkg. J (12-5804) | \$596.62 |

*Please specify finish.

| Part No. | Price |
|---|----------|
| 32-7238 Misc. Pkg. K (12-5804/12-5813) | \$626.29 |
| 32-7239 Misc. Pkg. L (12-5810) | \$559.21 |
| 32-7240 Misc. Pkg. M (12-5815) | \$626.29 |
| * 351C Plastic Cover | \$41.00 |
| 52-0045 Sounder Horn | \$84.36 |
| 52-0047 Red LED for Keyswitch | \$18.31 |
| 52-0048 Green LED for Keyswitch | \$18.31 |
| 52-0049 Single Gang Cover Plate (w/cyl. hole) | \$47.76 |
| 52-0050 Single Gang Cover Plate (w/cyl. and LED holes) | \$52.53 |
| 52-0051 Dbl. Gang Cover Plate (w/cyl. LED's, horn hole) | \$60.48 |
| 52-0052 Dbl. Gang Cover Plate (w/cyl., LED holes) | \$57.29 |
| 52-0053 Dbl. Gang Cover Plate (w/cyl. hole) | \$52.53 |
| 52-0054 Dbb. Gang Cover Plate (w/cyl. and horn hole) | \$57.29 |
| 52-0069 KP I/S Battery Cover | \$13.54 |
| * 52-0091 Keypad Cyl. Cover | \$91.66 |
| 52-0136 Lens Cover | \$1.82 |
| 52-0328 Transformer (351 EHT/EHTD) | \$92.31 |
| 52-2099 SPDT Momentary Switch Assy | \$65.26 |
| 52-2102 SPDT Maintained Switch Assy | \$65.26 |
| 52-2104 DPDT Momentary Switch Assy | \$87.55 |
| 52-2105 DPDT Maintained Switch Assy | \$87.55 |
| 52-2204 Latchbolt Mon. Sw./Harness (Rim Device) | \$71.64 |
| 52-2217 59-80 CVR Switch Assy. | \$71.64 |
| 52-2220 Latchbolt Mon. Sw./Harness (CVR) | \$73.22 |
| 52-2290 Battery Backup Board | \$545.91 |
| 52-2320 AL-80 Switch Assy. | \$35.00 |
| 52-2675 AL Circuit Board (New) | \$213.26 |
| * 60-0529 Washer | \$4.30 |
| * 60-2179 Mortise Nut Pack (2 1/4" Door Thickness) | \$14.48 |
| * 63-0156 OT Channel | \$83.29 |
| 63-0228 Circuit Mounting Post | \$3.56 |
| 63-0259 Smoke Detector Mtg. Post | \$19.13 |
| 63-0290 Switch Guide | \$12.10 |
| 63-0374 Wickman Fuse 1/4 Amp | \$11.81 |
| 63-0498 Circuit Brd. Screw Spacer | \$1.00 |
| 63-0501 Smoke Det. Mtg. Screw | \$0.68 |
| * 63-0502 Flat Head Tapping Screw 12 x 3/8" | \$0.88 |
| 63-0509 Circuit Brd. Mtg. Screw | \$1.71 |
| 63-0541 Conduit Support | \$28.58 |
| * 63-0665 2900 4 x 12 Pozidriv Screw | \$15.67 |
| 63-0704 351 EHT Slide | \$8.37 |
| 63-0705 Slide | \$9.55 |
| * 63-0708 End Cap (2408) | \$9.34 |
| * 63-0716 Latch Cover (351 EHT) | \$72.44 |
| 63-0723 Conduit Adapter Plug 1/2" (EHT) | \$4.82 |
| 63-0727 Circuit Board Insulator(EHT) | \$4.82 |
| 63-0728 Hole Plug 1/4"(EHT) | \$2.42 |
| * 63-0730 Optional - Metal Cover (Non-handed) | \$50.53 |
| 63-0732 Spacer (Pull) - 2408 | \$9.34 |
| 63-0733 Track Insert (Push) - 2498 | \$3.53 |
| 63-0734 Track Insert (Pull) - 2468/2478 | \$3.53 |
| * 63-2216 O Foot Assembly | \$41.14 |
| * 63-2217 OZ Foot Assembly | \$51.33 |
| * 63-2218 OZA Foot Assembly | \$51.33 |
| * 63-2607 Main Arm Assembly-12" | \$51.33 |
| 63-2868 Output Connector Assy | \$22.98 |
| * 63-2874 Link Extension Assembly (Main Arm 351EHT) | \$118.15 |
| * 63-3056 Dbl. Egress Arm-RH | \$201.26 |

EL-12 ELECTRICAL

PARTS

USA & Canada Prices Effective June 3, 2019

SARGENT
ASSA ABLOY

| Part No. | Price |
|---|------------|
| * 63-3057 Dbl. Egress Arm-LH | \$201.26 |
| 63-3210 Smoke Detector Assembly | \$502.21 |
| 63-3212 Accessory Wire Pack | \$210.96 |
| 63-3226 Tamper Switch & Wire Assy | \$177.11 |
| * 63-3314 OY Arm Assembly-16" | \$393.80 |
| * 63-3315 OYA Arm Assembly-18" | \$393.80 |
| 63-3413 Switch and Plug Assembly | \$88.66 |
| 63-3424 Mounting Plate (Long-Push) | \$47.34 |
| 63-3425 Mounting Plate (Long-Pull) | \$47.34 |
| 63-3426 Mounting Plate (Short Push Side) | \$47.34 |
| 63-3431 Screw Pack | \$13.98 |
| * 63-3653 2900 Main Arm Assy LH | \$229.30 |
| * 63-3654 2900 Main Arm Assy RH | \$229.30 |
| * 63-3688 2900 Slide Arm Assy Rigid | \$143.38 |
| * 63-3689 2900 Slide Arm Assy | \$315.52 |
| * 63-3699 2900 Roller/End Cap PK | \$45.85 |
| 63-3700 2900 Screw Pack | \$22.93 |
| * 63-3717 2900 Cover Assy-Regular | \$482.84 |
| * 63-3718 2900 Cover Assy Smk Det. | \$482.84 |
| 63-3719 2900 Closer Body Assy | \$1,147.34 |
| * 63-3733 2900LH 24VDC CLS/Holder | \$1,460.54 |
| * 63-3734 2900RH 24VDC CLS/Holder | \$1,460.54 |
| 63-3787 2900 Hold Open Pack | \$460.05 |
| * 63-4200 EHT Track Assy | \$717.29 |
| 63-4201 EHT Latch Assy | \$358.63 |
| 63-4202 EHT Circuit Board | \$215.18 |
| * 63-4206 EHT Arm and Roller Assy | \$95.61 |
| 63-4211 EHT Parts Pack | \$23.00 |
| 63-4212 EHT Standard Screw Pack | \$20.70 |
| 63-4215 Circuit Board 120 VAC | \$478.21 |
| 63-4216 Circuit Board 24 VAC/DC | \$262.97 |
| * 63-4219 Arm and Roller Assembly | \$83.71 |
| 63-4233 Latch Assembly | \$358.63 |
| * 63-4238 12-2468 24VAC/DC Track Assy. | \$1,420.20 |
| * 63-4239 12-2468 120VAC Track Assy. | \$1,420.20 |
| * 63-4240 12-2498 24VAC/DC Track Assy. | \$1,420.20 |
| * 63-4241 12-2498 120VAC Track Assy. | \$1,420.20 |
| * 63-4245 2468 24AC/DC Track Assy. | \$781.12 |
| * 63-4246 2468 120VAC Track Assy. | \$781.12 |
| * 63-4247 2498 24AC/DC Track Assy. | \$781.12 |
| * 63-4248 2498 120VAC Track Assy. | \$781.12 |
| * 63-4252 9-2468 (Pull) Track Assy. | \$781.12 |
| * 63-4253 9-2498 (Push) Track Assy. | \$781.12 |
| 68-0658 Switch Mounting Brkt | \$3.55 |
| 68-0704 Decal for Delayed Egress | \$54.46 |
| 68-2597 Bridge Rect. Pack | \$26.48 |
| 68-2759 55- Switch | \$84.87 |
| 68-3034 57- Circuit Board and Switch Assy | \$968.54 |
| 82-3618 Locking Tail Assy (8272/73) | \$25.10 |

*Please specify finish.

PROFILE SERIES - STAND ALONE PRODUCTS

How to Order/ANSI Finish & Function Comparison.....PS-1

10-Line Cylindrical Lock - KP, G1, RF Technology

10-Line Stand Alone Products Options.....PS-2

10-Line Keypad, Profile Series, RF Technology.....PS-3

8200 Series Mortise Lock - KP, G1, RF Technology

8200 Stand Alone Products Options.....PS-4

8200 Keypad, Profile Series.....PS-5

8200 Stand Alone Products Options.....PS-6

8200 RF Technology.....PS-7

80 Series - Rim & Mortise Exit Device - KP, G1, RF Technology

8800/8900/ Stand Alone Products Options.....PS-8

8800/8900 Keypad, Profile Series, RF Technology.....PS-9

Accessories.....PS-10

Parts & Accessories.....PS-11

10-Line Parts & Accessories.....PS-12

8200 Series Parts & Accessories

8200 Keypad Trim and Parts.....PS-13

8200 Stand Alone Products Trim/Parts.....PS-14

80 Series Parts & Accessories

80 Series Trim & Trim Kits.....PS-15

80 Series Parts & Accessories.....PS-16

| How to Order | | |
|---------------------|--|-----------------------------------|
| Step | Description | Example |
| Bored | | |
| Quantity | Each | 10 Ea. |
| Option | Consult catalog for options available | 10 Ea. 10- |
| Product Series | 10L Profile Series | 10 Ea. 10-10 |
| Function | 10G77 | 10 Ea. 10-10G77 |
| Technology/Trim | Consult catalog for available technology and lever designs | 10 Ea. 10-G1-10G77 PKL |
| Finish | Consult catalog for available finishes | 10 Ea. 10-G1-10G77 PKL 26D |

| Mortise | | |
|-----------------|--|--------------------------------------|
| Quantity | Each | 10 Ea. |
| Option | Consult catalog for options available | 10 Ea. 10- |
| Product Series | 8200 Profile Series | 10 Ea. 10-82 |
| Function | Consult catalog for available functions | 10 Ea. 10-8276 |
| Technology/Trim | Consult catalog for technology and available lever designs | 10 Ea. 10-G1-8276 PKL |
| Finish | Consult catalog for available finishes | 10 Ea. 10-G1-8276 PKL 26D |
| Hand | Specify Hand | 10 Ea. 10-G1-8276 PKL 26D RHR |

| Exit | | |
|------------------|---|---|
| Quantity | Each | 10 Ea. |
| Option | Consult catalog for options available | 10 Ea. 12- |
| Technology | LU | 10 Ea. 12-G1-LU |
| Product Series | 80 Series Profile Series | 10 Ea. 12-G1-LU-88 |
| Function | Consult catalog for available functions | 10 Ea. 12-G1-LU-8877 |
| Trim - ET | Consult catalog for available lever designs | 10 Ea. 12-G1-LU-8877 ETL |
| Finish (Trim/ET) | Consult catalog for available finishes | 10 Ea. 12-G1-LU-8877 ETL 26D/32D |
| Hand | Specify Hand | 10 Ea. 12-G1-LU-8877 ETL 26D/32D RHR |
| Door Size | Specify Door width | 10 Ea. 12-G1-LU-8877 ETL 26D/32D RHR x 36" |

| Technology Catalog # | Description |
|-----------------------------|---|
| KP | Keypad - 100 User |
| LK | Profile Series - Keypad - 100 Users |
| G1-LU | Profile Series - Keypad - 2,000 Users |
| G1-PA | Profile Series - Prox only - 2,000 Users |
| G1-PK | Profile Series - Prox & Keypad - 2,000 Users |
| G1-TU | Profile Series - RF Actuation Keypad - 2,000 Users |
| G1-TA | Profile Series - RF Actuation Prox only - 2,000 Users |
| G1-TP | Profile Series - RF Actuation Prox & Keypad - 2,000 users |

| Function Catalog # | Description |
|---------------------------|--------------------|
|---------------------------|--------------------|

| | |
|-------------------|-----------------------------------|
| Bored Lock | |
| 10G77 | Entry Lock with cylinder override |

| Mortise Lock | |
|---------------------|--|
|---------------------|--|

| | |
|-------|---|
| 8276 | Entry Lock with cylinder override and deadbolt |
| 8277 | Entry Lock with deadbolt (no cylinder) |
| 8278 | Entry Lock with cylinder override (no deadbolt) |
| 8279 | Entry Lock (no cylinder or deadbolt) |
| 82243 | Dorm Room Anti-Lock w/deadbolt & 1/5 Lever Switch |

| 80 Series Exit - Rim | |
|-----------------------------|--|
|-----------------------------|--|

| | |
|------|---------------------------|
| 8877 | with cylinder override |
| 8878 | without cylinder override |

| 80 Series Exit - Mortise | |
|---------------------------------|--|
|---------------------------------|--|

| | |
|------|---------------------------|
| 8977 | with cylinder override |
| 8978 | without cylinder override |

| Finish SARGENT | Description | ANSI |
|-----------------------|--------------------|-------------|
|-----------------------|--------------------|-------------|

| | | |
|--------|--|-----|
| US3 | Polished brass | 605 |
| US4 | Satin brass | 606 |
| US9 | Polished bronze | 611 |
| US10 | Satin bronze, clear powder coat | 612 |
| US10B | Oxidized satin bronze oil rubbed | 613 |
| US10BL | Oxidized satin bronze, clear powder coat | — |
| US14 | Bright nickel, clear coated | 618 |
| US15 | Satin nickel, clear coated | 619 |
| US20D | Dark statuary bronze, clear powder coat | — |
| US26 | Polished chrome | 625 |
| US26D | Satin chrome | 626 |
| US32 | Polished stainless steel | 629 |
| US32D | Satin stainless steel | 630 |
| BSP | Black Suede Powder Coat | — |
| WSP | White Suede Powder Coat | — |

Note: Refer to each price page for available finishes by product series.

PS-2 PROFILE SERIES

SARGENT®

10-LINE STAND ALONE PRODUCTS

ASSA ABLOY

USA & Canada Prices Effective June 3, 2019

| Options | Description | Price |
|---------|---|------------------------|
| 10 | SARGENT Signature Key System | \$58.00 /cyl |
| 11 | SARGENT XC Key System (not available with 10, 22, SC, SE) | No addition |
| 1160 | SARGENT XC Large Format Interchangeable Plastic Disposable Construction Core | No addition |
| 1163 | SARGENT XC Large Format Interchangeable Core Cylinder - Includes masterkeying charges | \$77.00 |
| 1164 | SARGENT XC Large Format Interchangeable Construction Core Cylinder | \$77.00 |
| 1170 | Small Format interchangeable disposable construction core - to accept 7 Pin XC permanent core | No Add |
| 11727P | Small Format interchangeable keyed construction core - to accept 7 Pin XC permanent core | \$69.00 |
| 11737P | Small Format interchangeable core - to accept 7 pin XC permanent core | \$69.00 / cyl. |
| 21 | SARGENT Construction Key System (lost ball) - for new systems est. since 5/1/96 | \$16.00 /cyl |
| 22 | SARGENT Construction Key System (split key) - for pre-est. split key systems only | \$32.00 /cyl |
| 23 | Lockset x 3 3/4" Backset | \$10.00 |
| 25 | Lockset x 5" Backset | \$15.00 |
| 28 | Lockset x ANSI A115.2-1971 Strike #808: - Lip lengths 1-1/8", 1-1/4" or 1-3/8" - Lip Lengths 1-5/8" to 2-7/8" in 1/4" increments | No addition \$11.00 |
| 30 | 10 Line Lever to accept Schlage cylinder (no cylinder provided) | No addition |
| 36 | 6 Lobe head security screws | \$14.00 |
| 37 | Spanner head security screws | \$9.00 |
| 41 | 3/4" throw with latch | \$98.00 |
| 60 | SARGENT Large Format Interchangeable Plastic Disposable Construction Core | No addition |
| 63 | SARGENT Large Format Interchangeable Core Cylinder includes master and grandmaster keying charge | \$77.00 |
| 64 | SARGENT Large Format Interchangeable Construction Core Cylinder | \$77.00 |
| 6573 | Small Format 6-Pin Uncombined Core (Refer to CK-12) Not available with J lever | \$59.00 |
| 65737P | Small Format 7-Pin Uncombined Core (Refer to CK-12) Not available with J lever | \$59.00 |
| 70 | Small Format Interchangeable disposable plastic construction core (not avail. w/J Lever) | No addition |
| 72 | Small Format Interchangeable 6-Pin construction core (not avail. w/J Lever)(7-Pin with 11 option) | \$69.00 |
| 73 | Small Format Interchangeable 6-Pin core (not avail. w/J Lever) | \$69.00 /cyl. |
| 737P | Small Format Interchangeable 7-Pin core (not avail. w/J Lever) | \$69.00 /cyl. |
| 75 | Tactile Warning - Milled on backside of inside lever (Not available with Coastal Levers) | \$37.00 |
| 76 | Tactile Warning - Milled on backside of outside lever (Not available with Coastal Levers) | \$37.00 |
| 77 | Tactile Warning - Milled on backside of both levers (Not available with Coastal Levers) | \$74.00 |
| 80 | Levers to accept KESO and KESO F1 - no cylinder provided (not avail. w/J Lever) | -\$87.00/cyl. |
| 82 | SARGENT KESO Security Cylinder (not avail. w/J Lever) (for existing systems) | \$84.00 /cyl |
| F182 | SARGENT KESO Security Cylinder - Patented - (not avail. w/J Lever) | \$84.00 /cyl |
| 85 | Tactile Warning - Abrasive coating on inside lever | \$45.00 |
| 86 | Tactile Warning - Abrasive coating on outside lever | \$45.00 |
| 87 | Tactile Warning - Abrasive coating on both levers | \$90.00 |
| 91 | Remote Power/Unlocking - requires 3267 Power Supply | \$40.00 |
| BR | SARGENT Bump Resistant Cylinders (N/A w/10, 22, 30, 60, 63, 64, 70, 72, 73, 737P, KESO, SC, SE) | Add \$23.00 /cyl. |
| DG1 | Patented Degree DG1 Key System | No Addition |
| DG160 | Hardware prepared for DG1-6300 Lg. Format IC cores, supplied with temporary plastic construction cores | No addition |
| DG163 | Patented Degree DG1 Large Format Interchangeable Core Cylinder - Includes master keying charges | \$77.00 |
| DG164 | Hardware prepared for DG1-6300 Lg. Format IC cores, supplied with temporary keyed construction cores | \$77.00 |
| DG2 | Patented Degree DG2 Key System incorporating a locking sidebar | \$58.00/cyl. |
| DG260 | Hardware prepared for DG2-6300 Lg. Format IC cores, supplied with temporary plastic construction cores | No addition |
| DG263 | Patented Degree DG2 Large Format Interchangeable Core Cylinder - Includes master keying charges | \$133.00 |
| DG264 | Hardware prepared for DG2-6300 Lg. Format IC cores, supplied with temporary keyed construction cores | \$77.00 |
| DG3 | Patented Degree DG3 Key System incorporating a locking sidebar and UL437 listed | \$82.00/cyl. |
| DG360 | Hardware prepared for DG3-6300 Lg. Format IC cores, supplied with temporary plastic construction cores | No addition |
| DG363 | Patented Degree DG3 Large Format Interchangeable Core Cylinder - Includes master keying charges | \$156.00 |
| DG364 | Hardware prepared for DG3-6300 Lg. Format IC cores, supplied with temporary keyed construction cores | \$77.00 |
| DM | Forced/propped door harness (not available on 82243) | Add \$12.00 |
| LC | Less Cylinder | -\$87.00/cyl. |
| SC | Schlage C Keyway cylinder, 0-bitted | No addition |
| SE | Schlage E Keyway cylinder, 0-bitted | No addition |
| SF | L Lever to accept Schlage Large Format Interchangeable Core (supplied less core, tailpiece included) | No Addition |
| SG | MicroShield® an antimicrobial powder coat finish | \$67.00 |
| WBS | Wrought Box Strike | No Addition |

USA & Canada Prices Effective June 3, 2019



10L-Keypad

Rose Designs: L & G

Standard Lever Designs: B, J, L, P

Coastal Lever Designs: Y & G

| Function | | | 10BE/26D/ BSP/WSP | 03/04/09/10/10B 10BL/14/15/20D/26 |
|----------|----------|---|----------------------|--------------------------------------|
| Option | Function | Single Cylinder | | |
| KP | 10G77 | Storeroom x Rose x Lever Design (100 users) | \$1,075.00 | \$1,180.00 |



10L-Profile Series

Standard Lever Designs: B, J, L, P

Coastal Lever Designs: Y & G

| 10L Profile Series | | | | 10BE/26D/ BSP/WSP | 03/04/09/10/10B 10BL/14/15/20D/26 |
|--------------------|----------|-------------------|--|----------------------|--------------------------------------|
| Option | Function | Trim | Description | | |
| | 10G77 | LK x Lever Design | Keypad Entry Lock with Cylinder Override (100 Users) | \$1,182.00 | \$1,287.00 |
| G1 | 10G77 | LU x Lever Design | Keypad Entry Lock with Cylinder Override (2,000 Users) | \$1,355.00 | \$1,460.00 |
| G1 | 10G77 | PA x Lever Design | *Proximity Only Entry Lock with Cylinder Override (2,000 Users) | \$1,836.00 | \$1,941.00 |
| G1 | 10G77 | PK x Lever Design | Proximity and Keypad Entry Lock with Cylinder Override (2,000 Users) | \$1,909.00 | \$2,014.00 |

*Requires SoloPlus for programming.

| 10L Profile Series with RF Technology | | | | 10BE/26D/ BSP/WSP | 03/04/09/10/10B 10BL/14/15/20D/26 |
|---------------------------------------|----------|-------------------|---|----------------------|--------------------------------------|
| Option | Function | Trim | Description | | |
| G1 | 10G77 | TU x Lever Design | RF Actuation Keypad Entry Lock with Cylinder Override (2,000 users) | \$1,593.00 | \$1,698.00 |
| G1 | 10G77 | TA x Lever Design | *RF Actuation Prox Only Entry Lock with Cylinder Override (2,000 users) | \$2,074.00 | \$2,179.00 |
| G1 | 10G77 | TP x Lever Design | RF Actuation Proximity & Keypad Entry Lock with Cylinder Override (2,000 users) | \$2,148.00 | \$2,253.00 |

Note: RF FOB must be ordered separate from locks – See page PS-10.

*Requires SoloPlus for programming.

PS-4 PROFILE SERIES

SARGENT®

8200 STAND ALONE PRODUCTS

ASSA ABLOY

USA & Canada Prices Effective June 3, 2019

| Options | Description | Price |
|---------|---|-------------------|
| 3 | Stainless Steel Hubs | \$63.00 |
| 10 | Sargent Signature System meeting UL437 | \$58.00 /cyl |
| 11 | SARGENT XC Key System (not available with 10, 22, SC, SE) | No addition |
| 1160 | SARGENT XC Large Format Interchangeable Plastic Disposable Construction Core | No addition |
| 1163 | SARGENT XC Large Format Interchangeable Core Cylinder - Includes masterkeying charges | \$77.00 |
| 1164 | SARGENT XC Large Format Interchangeable Construction Core Cylinder | \$77.00 |
| 1170 | Small Format interchangeable disposable construction core - to accept 7 Pin XC permanent core | No Add |
| 11727P | Small Format interchangeable keyed construction core - to accept 7 Pin XC permanent core | \$69.00 |
| 11737P | Small Format interchangeable core - to accept 7 pin XC permanent core | \$69.00 / cyl. |
| 21 | SARGENT Construction Key System (lost ball) - for new systems est. since 5/1/96 | \$16.00 /cyl |
| 22 | SARGENT Construction Key System (split key) - for pre-est. split key systems only | \$32.00 /cyl |
| 23 | 4-7/8" ANSI Strike | No addition |
| 36 | 6 Lobe head security screws | \$23.00 |
| 37 | Spanner head security screws | \$16.00 |
| 60 | SARGENT Large Format Interchangeable Plastic Disposable Construction Core | No addition |
| 63 | SARGENT Large Format Interchangeable Core Cylinder includes master and grandmaster keying charge | \$77.00 |
| 64 | SARGENT Large Format Interchangeable Construction Core Cylinder | \$77.00 |
| 6573 | Small Format 6-Pin Uncombined core (Refer to CK-12) Not available with J Lever | \$59.00 /cyl. |
| 65737P | Small Format 7-Pin uncombined core (Refer to CK-12) Not available with J Lever | \$59.00 /cyl. |
| 70 | Small Format Interchangeable disposable plastic construction core | No addition |
| 72 | Small Format Interchangeable 6-Pin construction core (7-Pin with 11 option) | \$69.00 |
| 73 | Small Format Interchangeable 6-Pin core | \$69.00 /cyl. |
| 737P | Small Format Interchangeable 7-Pin core | \$69.00 /cyl. |
| 75 | Tactile Warning - Milled on backside of inside lever (Not available with Studio & Coastal Levers and the A Lever) | \$72.00 |
| 76 | Tactile Warning - Milled on backside of outside lever (Not available with Studio & Coastal Levers and the A Lever) | \$72.00 |
| 77 | Tactile Warning - Milled on backside of both levers (Not available with Studio & Coastal Levers and the A Lever) | \$144.00 |
| 81 | Cylinder to accept KESO & KESO F1 removable core - no core provided | No addition |
| 82 | SARGENT KESO Security Cylinder (for existing systems) | \$84.00 /cyl |
| F182 | SARGENT KESO Security Cylinder - Patented | \$84.00 /cyl |
| 83 | SARGENT KESO Security Removable core cylinder (for existing systems) | \$120.00 /cyl |
| F183 | SARGENT KESO Security Removable core cylinder - Patented | \$120.00 /cyl |
| 84 | SARGENT KESO Security removable construction core cylinder | See CK-18 |
| 85 | Tactile Warning - Abrasive coating on inside lever | \$45.00 |
| 86 | Tactile Warning - Abrasive coating on outside lever | \$45.00 |
| 87 | Tactile Warning - Abrasive coating on both levers | \$90.00 |
| 91 | Remote Power/Unlocking - requires 3267 Power Supply | \$40.00 |
| BR | SARGENT Bump Resistant Cylinders (N/A w/10, 22, 30, 60, 63, 64, 70, 72, 73, 737P, KESO, SC, SE) | Add \$23.00 /cyl. |
| DG1 | Patented Degree DG1 Key System | No Addition |
| DG160 | Hardware prepared for DG1-6300 Lg. Format IC cores, supplied with temporary plastic construction cores | No addition |
| DG163 | Patented Degree DG1 Large Format Interchangeable Core Cylinder - Includes master keying charges | \$77.00 |
| DG164 | Hardware prepared for DG1-6300 Lg. Format IC cores, supplied with temporary keyed construction cores | \$77.00 |
| DG2 | Patented Degree DG2 Key System incorporating a locking sidebar | \$58.00/cyl. |
| DG260 | Hardware prepared for DG2-6300 Lg. Format IC cores, supplied with temporary plastic construction cores | No addition |
| DG263 | Patented Degree DG2 Large Format Interchangeable Core Cylinder - Includes master keying charges | \$133.00 |
| DG264 | Hardware prepared for DG2-6300 Lg. Format IC cores, supplied with temporary keyed construction cores | \$77.00 |
| DG3 | Patented Degree DG3 Key System incorporating a locking sidebar and UL437 listed | \$82.00/cyl. |
| DG360 | Hardware prepared for DG3-6300 Lg. Format IC cores, supplied with temporary plastic construction cores | No addition |
| DG363 | Patented Degree DG3 Large Format Interchangeable Core Cylinder - Includes master keying charges | \$156.00 |
| DG364 | Hardware prepared for DG3-6300 Lg. Format IC cores, supplied with temporary keyed construction cores | \$77.00 |
| DM | Forced/propped door harness (not available on 82243) | Add \$12.00 |
| LC | Less Cylinder | -\$89.00/cyl. |
| PHR | Pharmacy | \$156.00 |
| SC | Schlage C keyway cylinder "0" bitted (not available with Profile Series) | No addition |
| SE | Schlage E keyway cylinder "0" bitted (not available with Profile Series) | No addition |
| SG | MicroShield® - an antimicrobial powder coat | \$67.00 |
| WBS | Wrought Box Strike | No Addition |

ASSA ABLOY

8200 STAND ALONE PRODUCTS

USA & Canada Prices Effective June 3, 2019



8200 KEYPAD

Standard Rose Designs: LN, L
Standard Lever Designs: A, B, E, F, J, L, P, W

Coastal Rose Designs: CR, TR
Coastal Lever Designs: G, R, S, Y

Studio Rose Designs: E2, E3, E4, CO, TO, CR, TR, LN, O
Studio Collection Levers Except for Gramercy, Wooster Square, & Grant Park

For Gramercy, Wooster Square, & Grant Park Levers – Add \$138.00 to below prices
Consult catalog for available lever designs, finishes, & ordering information.

| Option | Function | Description | 10BE/26D/ BSP/WSP | 03/04/09/10/10B/ 10BL/14/15/20D/26 |
|--------|----------|--|----------------------|---------------------------------------|
| KP | 8276 | Keypad Entry lock with cylinder override | \$1,175.00 | \$1,333.00 |
| KP | 8277 | Keypad Entry lock - no cylinder available | \$1,107.00 | \$1,265.00 |
| KP | 8278 | Keypad Entry lock with cylinder override, no deadbolt | \$1,155.00 | \$1,313.00 |
| KP | 8279 | Keypad Entry lock - no cylinder override and no deadbolt | \$1,084.00 | \$1,242.00 |



8200 PROFILE SERIES

Standard Lever Designs: A, B, E, F, J, L, P, W

Coastal Lever Designs: G, R, S, Y

Studio Collection Levers Except for Gramercy, Wooster Square, & Grant Park

For Gramercy, Wooster Square, & Grant Park Levers – Add \$138.00 to below prices
Consult catalog for available lever designs, finishes, & ordering information.

| 8200 Profile Series | | | 10BE/26D/ BSP/WSP | 03/04/09/10/10B/ 10BL/14/15/20D/26 |
|----------------------------|--|--|----------------------|---------------------------------------|
| Option/Function/Trim | Description | | | |
| G1 82243 PA x Lever Design | *Proximity ONLY Dorm Room Anti-lock w/D.bolt and I/S Lever Switch (2,000 Users) | | \$2,256.00 | \$2,414.00 |
| G1 82243 PK x Lever Design | Proximity Keypad Dorm Room Anti-lock w/D.bolt and I/S Lever Switch (2,000 Users) | | \$2,325.00 | \$2,483.00 |
| 8276 LK x Lever Design | Keypad Entry Lock w/Cylinder Override, w/Deadbolt (100 Users) | | \$1,275.00 | \$1,433.00 |
| G1 8276 LU x Lever Design | Keypad Entry Lock w/Cylinder Override, w/Deadbolt (2,000 Users) | | \$1,450.00 | \$1,608.00 |
| G1 8276 PA x Lever Design | *Proximity ONLY Entry Lock w/Cylinder Override, w/Deadbolt (2,000 Users) | | \$1,943.00 | \$2,101.00 |
| G1 8276 PK x Lever Design | Proximity and Keypad Entry Lock w/Cyl. Override, w/Deadbolt (2,000 Users) | | \$2,013.00 | \$2,171.00 |
| 8277 LK x Lever Design | Keypad Entry Lock w/o Cylinder Override, w/Deadbolt (100 Users) | | \$1,215.00 | \$1,373.00 |
| G1 8277 LU x Lever Design | Keypad Entry Lock w/o Cylinder Override, w/Deadbolt (2,000 Users) | | \$1,394.00 | \$1,552.00 |
| G1 8277 PA x Lever Design | *Proximity ONLY Entry Lock w/o Cylinder Override, w/Deadbolt (2,000 Users) | | \$1,880.00 | \$2,038.00 |
| G1 8277 PK x Lever Design | Proximity and Keypad Entry Lock w/o Cyl. Override, w/Deadbolt (2,000 Users) | | \$1,953.00 | \$2,111.00 |
| 8278 LK x Lever Design | Keypad Entry Lock w/Cylinder Override, w/o Deadbolt (100 Users) | | \$1,257.00 | \$1,415.00 |
| G1 8278 LU x Lever Design | Keypad Entry Lock w/Cylinder Override, w/o Deadbolt (2,000 Users) | | \$1,434.00 | \$1,592.00 |
| G1 8278 PA x Lever Design | *Proximity ONLY Entry Lock w/Cylinder Override, w/o Deadbolt (2,000 Users) | | \$1,921.00 | \$2,079.00 |
| G1 8278 PK x Lever Design | Proximity and Keypad Entry Lock w/Cyl. Override, w/o Deadbolt (2,000 Users) | | \$1,997.00 | \$2,155.00 |
| 8279 LK x Lever Design | Keypad Entry Lock w/o Cylinder Override, w/o Deadbolt (100 Users) | | \$1,198.00 | \$1,356.00 |
| G1 8279 LU x Lever Design | Keypad Entry Lock w/o Cylinder Override, w/o Deadbolt (2,000 Users) | | \$1,374.00 | \$1,532.00 |
| G1 8279 PA x Lever Design | *Proximity ONLY Entry Lock w/o Cylinder Override, w/o Deadbolt (2,000 Users) | | \$1,863.00 | \$2,021.00 |
| G1 8279 PK x Lever Design | Proximity and Keypad Entry Lock w/o Cyl. Override, w/o Deadbolt (2,000 Users) | | \$1,940.00 | \$2,098.00 |

Note: RF FOB must be ordered separate from locks – See page PS-10.

*Requires SoloPlus for programming.

PS-6 PROFILE SERIES

SARGENT®

8200 STAND ALONE PRODUCTS

ASSA ABLOY

USA & Canada Prices Effective June 3, 2019

| Options | Description | Price |
|---------|--|-------------------|
| 3 | Stainless Steel Hubs | \$63.00 |
| 10 | SARGENT Signature Key System | \$58.00 /cyl |
| 11 | SARGENT XC Key System (not available with 10, 22, SC, SE) | No addition |
| 1160 | Sargent XC Large Format Interchangeable Plastic Disposable Construction Core | No addition |
| 1163 | Sargent XC Large Format Interchangeable Core Cylinder - Includes masterkeying charges | \$77.00 |
| 1164 | Sargent XC Large Format Interchangeable Construction Core Cylinder | \$77.00 |
| 1170 | Small Format interchangeable disposable construction core - to accept 7 Pin XC permanent core | No Add |
| 11727P | Small Format interchangeable keyed construction core - to accept 7 Pin XC permanent core | \$69.00 |
| 11737P | Small Format interchangeable core - to accept 7 pin XC permanent core | \$69.00 / cyl. |
| 21 | SARGENT Construction Key System (lost ball) - for new systems est. since 5/1/96 | \$16.00 /cyl |
| 22 | SARGENT Construction Key System (split key) - for pre-est. split key systems only | \$32.00 /cyl |
| 23 | 4-7/8" ANSI Strike | No addition |
| 36 | 6 Lobe head security screws | \$23.00 |
| 37 | Spanner head security screws | \$16.00 |
| 60 | SARGENT Large Format Interchangeable Plastic Disposable Construction Core | No addition |
| 63 | SARGENT Large Format Interchangeable Core Cylinder includes master and grandmaster keying charge | \$77.00 |
| 64 | SARGENT Large Format Interchangeable Construction Core Cylinder | \$77.00 |
| 6573 | Small Format 6-Pin Uncombined Core (Refer to CK-12) Not available with J lever | \$59.00 |
| 65737P | Small Format 7-Pin Uncombined Core (Refer to CK-12) Not available with J lever | \$59.00 |
| 70 | Small Format interchangeable disposable plastic construction core (Not available with J lever) | No addition |
| 72 | Small Format interchangeable 6-Pin construction core (not available with J lever) | \$69.00 |
| 73 | Small Format interchangeable core 6-pin Includes MK and GMK keying charges (Not available with J lever) | \$69.00 |
| 737P | Small Format interchangeable core 7-pin (refer to CK-12 for available keyways) Includes MK and GMK keying charges (Not available with J lever) | \$69.00 |
| 75 | Tactile Warning - Milled on backside of inside lever (Not available with Studio & Coastal Levers and the A Lever) | \$72.00 |
| 76 | Tactile Warning - Milled on backside of outside lever (Not available with Studio & Coastal Levers and the A Lever) | \$72.00 |
| 77 | Tactile Warning - Milled on backside of both levers (Not available with Studio & Coastal Levers and the A Lever) | \$144.00 |
| 81 | Cylinder to accept KESO & KESO F1 removable core - no core provided | No addition |
| 82 | SARGENT KESO Security Cylinder (for existing systems) | \$84.00 /cyl |
| F182 | SARGENT KESO Security Cylinder - Patented | \$84.00 /cyl |
| 83 | SARGENT KESO Security Removable core cylinder (for existing systems) | \$120.00 /cyl |
| F183 | SARGENT KESO Security Removable core cylinder - Patented | \$120.00 /cyl |
| 84 | SARGENT KESO Security removable construction core cylinder | See CK-18 |
| 85 | Tactile Warning - Abrasive coating on inside lever | \$45.00 |
| 86 | Tactile Warning - Abrasive coating on outside lever | \$45.00 |
| 87 | Tactile Warning - Abrasive coating on both levers | \$90.00 |
| 91 | Remote Power/Unlocking - requires 3267 Power Supply | \$40.00 |
| BR | SARGENT Bump Resistant Cylinders (N/A w/10, 22, 30, 60, 63, 64, 70, 72, 73, 737P, KESO, SC, SE) | Add \$23.00 /cyl. |
| DG1 | Patented Degree DG1 Key System | No Addition |
| DG160 | Hardware prepared for DG1-6300 Lg. Format IC cores, supplied with temporary plastic construction cores | No addition |
| DG163 | Patented Degree DG1 Large Format Interchangeable Core Cylinder - Includes master keying charges | \$77.00 |
| DG164 | Hardware prepared for DG1-6300 Lg. Format IC cores, supplied with temporary keyed construction cores | \$77.00 |
| DG2 | Patented Degree DG2 Key System incorporating a locking sidebar | \$58.00/cyl. |
| DG260 | Hardware prepared for DG2-6300 Lg. Format IC cores, supplied with temporary plastic construction cores | No addition |
| DG263 | Patented Degree DG2 Large Format Interchangeable Core Cylinder - Includes master keying charges | \$133.00 |
| DG264 | Hardware prepared for DG2-6300 Lg. Format IC cores, supplied with temporary keyed construction cores | \$77.00 |
| DG3 | Patented Degree DG3 Key System incorporating a locking sidebar and UL437 listed | \$82.00/cyl. |
| DG360 | Hardware prepared for DG3-6300 Lg. Format IC cores, supplied with temporary plastic construction cores | No addition |
| DG363 | Patented Degree DG3 Large Format Interchangeable Core Cylinder - Includes master keying charges | \$156.00 |
| DG364 | Hardware prepared for DG3-6300 Lg. Format IC cores, supplied with temporary keyed construction cores | \$77.00 |
| DM | Forced/propped door harness (not available on 82243) | Add \$12.00 |
| LC | Less Cylinder | -\$89.00/cyl. |
| SC | Schlage C Keyway cylinder, 0-bitted | No addition |
| SE | Schlage E Keyway cylinder, 0-bitted | No addition |
| SG | MicroShield® an antimicrobial powder coat finish | \$67.00 |

USA & Canada Prices Effective June 3, 2019



8200 PROFILE SERIES

Standard Lever Designs: A, B, E, F, J, L, P, W

Coastal Lever Designs: G, R, S, Y

Studio Collection Levers Except for Gramercy, Wooster Square, & Grant Park

For Gramercy, Wooster Square, & Grant Park Levers – Add \$138.00 to below prices
Consult catalog for available lever designs, finishes, & ordering information.

| 8200 Profile Series with RF Technology | | | 10BE/26D/ BSP/WSP | 03/04/09/10/10B 10BL/14/15/20D/26 |
|--|--|--|----------------------|--------------------------------------|
| Option/Function/Trim | Description | | | |
| G1 8276 TU x Lever Design | RF Actuation Keypad Entry Lock w/Cylinder Override, w/D.bolt (2,000 Users) | | \$1,696.00 | \$1,854.00 |
| G1 8276 TA x Lever Design | *RF Actuation Proximity Entry Lock w/Cylinder Override w/D.bolt (2,000 users) | | \$2,183.00 | \$2,341.00 |
| G1 8276 TP x Lever Design | RF Actuation Proximity & Keypad Entry Lock w/Cylinder Override, w/Deadbolt (2,000 Users) | | \$2,259.00 | \$2,417.00 |
| G1 8277 TU x Lever Design | RF Actuation Keypad Entry Lock w/o Cylinder Override, w/Deadbolt (2,000 Users) | | \$1,636.00 | \$1,794.00 |
| G1 8277 TA x Lever Design | *RF Actuation Proximity Entry Lock w/o Cylinder Override w/D.bolt (2,000 users) | | \$2,125.00 | \$2,283.00 |
| G1 8277 TP x Lever Design | RF Actuation Proximity & Keypad Entry Lock w/o Cylinder Override, w/Deadbolt (2,000 Users) | | \$2,198.00 | \$2,356.00 |
| G1 8278 TU x Lever Design | RF Actuation Keypad Entry Lock w/Cylinder Override, w/o Deadbolt (2,000 Users) | | \$1,676.00 | \$1,834.00 |
| G1 8278 TA x Lever Design | *RF Actuation Proximity Entry Lock w/Cylinder Override w/o D.bolt (2,000 users) | | \$2,165.00 | \$2,323.00 |
| G1 8278 TP x Lever Design | RF Actuation Proximity & Keypad Entry Lock w/Cylinder Override, w/o Deadbolt (2,000 Users) | | \$2,240.00 | \$2,398.00 |
| G1 8279 TU x Lever Design | RF Actuation Keypad Entry Lock w/o Cylinder Override, w/o Deadbolt (2,000 Users) | | \$1,618.00 | \$1,776.00 |
| G1 8279 TA x Lever Design | *RF Actuation Proximity Entry Lock w/o Cylinder Override w/o D.bolt (2,000 users) | | \$2,105.00 | \$2,263.00 |
| G1 8279 TP x Lever Design | RF Actuation Proximity & Keypad Entry Lock w/o Cylinder Override, w/o Deadbolt (2,000 Users) | | \$2,181.00 | \$2,339.00 |

Note: RF FOB must be ordered separate from locks – See page PS-10.

*Requires SoloPlus for programming.

PS-8 PROFILE SERIES

SARGENT®

8800/8900 STAND ALONE PRODUCTS

ASSA ABLOY

USA & Canada Prices Effective June 3, 2019

| Options | Description | Price |
|---------|---|-------------------|
| 10 | SARGENT Signature Key System | \$58.00 /cyl |
| 11 | SARGENT XC Key System (not available with 10, 22, SC, SE) | No addition |
| 1160 | Sargent XC Large Format Interchangeable Plastic Disposable Construction Core | No addition |
| 1163 | Sargent XC Large Format Interchangeable Core Cylinder - Includes masterkeying charges | \$77.00 |
| 1164 | Sargent XC Large Format Interchangeable Construction Core Cylinder | \$77.00 |
| 1170 | Small Format interchangeable disposable construction core - to accept 7 Pin XC permanent core | No Add |
| 11727P | Small Format interchangeable keyed construction core - to accept 7 Pin XC permanent core | \$69.00 |
| 11737P | Small Format interchangeable core - to accept 7 pin XC permanent core | \$69.00 / cyl. |
| 12 | UL Fire Label Exit Device | \$177.00 |
| 16 | Cylinder Lockdown feature in rail | \$123.00 |
| 19 | 80 Series pushbar without Lexan Touchpad | No addition |
| 21 | SARGENT Construction Key System (lost ball) - for new systems est. since 5/1/96 | \$16.00 /cyl |
| 22 | SARGENT Construction Key System (split key) - for pre-est. split key systems only | \$32.00 /cyl |
| 23 | 4-7/8" ANSI Strike | No Add |
| 36 | 6 Lobe head security screws (8800) | \$48.00 |
| 36 | 6 Lobe head security screws (8900) | \$52.00 |
| 37 | Spanner head security screws (8800) | \$31.00 |
| 37 | Spanner head security screws (8900) | \$34.00 |
| 60 | SARGENT Large Format Interchangeable Plastic Disposable Construction Core | No addition |
| 63 | SARGENT Large Format Interchangeable Core Cylinder includes master and grandmaster keying charge | \$77.00 |
| 64 | SARGENT Large Format Interchangeable Construction Core Cylinder | \$77.00 |
| 6573 | Small Format 6-Pin Uncombined Core (Refer to CK-12) Not available with J lever | \$59.00 |
| 65737P | Small Format 7-Pin Uncombined Core (Refer to CK-12) Not available with J lever | \$59.00 |
| 70 | Small Format Interchangeable disposable plastic construction core | No addition |
| 72 | Small Format Interchangeable 6-Pin construction core (7-Pin with 11 option) | \$69.00 |
| 73 | Small Format Interchangeable 6-Pin core | \$69.00 /cyl. |
| 737P | Small Format Interchangeable 7-Pin core | \$69.00 /cyl. |
| 76 | Tactile Warning - Milled on backside of outside lever (Not available with Studio & Coastal Levers and the A Lever) | \$71.00 |
| 81 | Cylinder to accept KESO & KESO F1 removable core - no core provided | No addition |
| 82 | SARGENT KESO Security Cylinder (for existing systems) | \$84.00 /cyl |
| F182 | SARGENT KESO Security Cylinder - Patented | \$84.00 /cyl |
| 83 | SARGENT KESO Security Removable core cylinder (for existing systems) | \$120.00 /cyl |
| F183 | SARGENT KESO Security Removable core cylinder - Patented | \$120.00 /cyl |
| 84 | SARGENT KESO Security removable construction core cylinder | See CK-18 |
| 85 | Tactile Warning - Abrasive strip on push rail | \$93.00 |
| 86 | Tactile Warning - Abrasive coating on outside lever | \$43.00 |
| 87 | Tactile Warning - Abrasive strip on push rail & abrasive coating on outside lever | \$136.00 |
| 91 | Remote Power/Unlocking - requires 3267 Power Supply | \$40.00 |
| BR | SARGENT Bump Resistant Cylinders (N/A w/10, 22, 30, 60, 63, 64, 70, 72, 73, 737P, KESO, SC, SE) | Add \$23.00 /cyl. |
| DG1 | Patented Degree DG1 Key System | No Addition |
| DG160 | Hardware prepared for DG1-6300 Lg. Format IC cores, supplied with temporary plastic construction cores | No addition |
| DG163 | Patented Degree DG1 Large Format Interchangeable Core Cylinder - Includes master keying charges | \$77.00 |
| DG164 | Hardware prepared for DG1-6300 Lg. Format IC cores, supplied with temporary keyed construction cores | \$77.00 |
| DG2 | Patented Degree DG2 Key System incorporating a locking sidebar | \$58.00/cyl. |
| DG260 | Hardware prepared for DG2-6300 Lg. Format IC cores, supplied with temporary plastic construction cores | No addition |
| DG263 | Patented Degree DG2 Large Format Interchangeable Core Cylinder - Includes master keying charges | \$133.00 |
| DG264 | Hardware prepared for DG2-6300 Lg. Format IC cores, supplied with temporary keyed construction cores | \$77.00 |
| DG3 | Patented Degree DG3 Key System incorporating a locking sidebar and UL437 listed | \$82.00/cyl. |
| DG360 | Hardware prepared for DG3-6300 Lg. Format IC cores, supplied with temporary plastic construction cores | No addition |
| DG363 | Patented Degree DG3 Large Format Interchangeable Core Cylinder - Includes master keying charges | \$156.00 |
| DG364 | Hardware prepared for DG3-6300 Lg. Format IC cores, supplied with temporary keyed construction cores | \$77.00 |
| DM | Forced/propped door harness (not available on 82243) | Add \$12.00 |
| LC | Less Cylinder | -\$89.00/cyl. |
| SC | Schlage C Keyway cylinder, 0-bitted | No addition |
| SE | Schlage E Keyway cylinder, 0-bitted | No addition |
| SG | MicroShield® an antimicrobial powder coat finish | \$82.00 |

ASSA ABLOY

8800/8900 STAND ALONE PRODUCTS

USA & Canada Prices Effective June 3, 2019



ET CONTROL

Standard Lever Designs: A, B, E, F, J, L, P, W

Coastal Lever Designs: G, R, S, Y

Studio Collection Levers Except for Gramercy, Wooster Square, & Grant Park

For Gramercy, Wooster Square, & Grant Park Levers – Add \$160.00 to below prices
Consult catalog for available lever designs, finishes, & ordering information.

| KP8800 and KP8900 Keypad Exit Devices | | | 10BE/32D BSP/WSP | 03/04/09/10/10B/ 10BL/20D/32 |
|---------------------------------------|-----------------|---|---------------------|---------------------------------|
| Option | Function | Description | | |
| KP | 8877 ET x lever | Keypad Rim Exit Device with cylinder override | \$2,757.00 | \$2,810.00 |
| KP | 8878 ET x lever | Keypad Rim Exit Device - no cylinder override | \$2,687.00 | \$2,740.00 |
| KP | 8977 ET x lever | Keypad Mortise Exit Device with cylinder override | \$3,048.00 | \$3,101.00 |
| KP | 8978 ET x lever | Keypad Mortise Exit Device - no cylinder override | \$2,974.00 | \$3,027.00 |



ET CONTROL

Standard Lever Designs: A, B, E, F, J, L, P, W

Coastal Lever Designs: G, R, S, Y

Studio Collection Levers Except for Gramercy, Wooster Square, & Grant Park

For Gramercy, Wooster Square, & Grant Park Levers – Add \$160.00 to below prices
Consult catalog for available lever designs, finishes, & ordering information.

| 8800 Profile Series Rim Exit Device | | | 10BE/32D/ BSP/WSP | 03/04/09/10/10B/ 10BL/20D/32 |
|-------------------------------------|---|--|----------------------|---------------------------------|
| Option/Function/Trim | | Description | | |
| LK8877 ET x Lever Design | | Keypad Rim Exit Device with Cylinder Override (100 Users) | \$2,433.00 | \$2,486.00 |
| G1 LU8877 ET x Lever Design | | Keypad Rim Exit Device with Cylinder Override (2,000 Users) | \$2,582.00 | \$2,635.00 |
| G1 PA8877 ET x Lever Design | * | Proximity ONLY Rim Exit Device with Cylinder Override (2,000 Users) | \$3,043.00 | \$3,096.00 |
| G1 PK8877 ET x Lever Design | | Proximity and Keypad Rim Exit Device with Cylinder Override (2,000 Users) | \$3,115.00 | \$3,168.00 |
| LK8878 ET x Lever Design | | Keypad Rim Exit Device without Cylinder override (100 Users) | \$2,372.00 | \$2,425.00 |
| G1 LU8878 ET x Lever Design | | Keypad Rim Exit Device without Cylinder override (2,000 Users) | \$2,523.00 | \$2,576.00 |
| G1 PA8878 ET x Lever Design | * | Proximity ONLY Rim Exit Device without Cylinder Override (2,000 Users) | \$2,984.00 | \$3,037.00 |
| G1 PK8878 ET x Lever Design | | Proximity and Keypad Rim Exit Device without Cylinder Override (2,000 Users) | \$3,052.00 | \$3,105.00 |

| 8900 Profile Series Mortise Exit Device | | | | |
|---|---|--|------------|------------|
| LK8977 ET x Lever Design | | Keypad Mortise Exit Device with Cylinder Override (100 Users) | \$2,680.00 | \$2,733.00 |
| G1 LU8977 ET x Lever Design | | Keypad Mortise Exit Device with Cylinder Override (2,000 Users) | \$2,828.00 | \$2,881.00 |
| G1 PA8977 ET x Lever Design | * | Proximity ONLY Mortise Exit Device with Cylinder Override (2,000 Users) | \$3,288.00 | \$3,341.00 |
| G1 PK8977 ET x Lever Design | | Proximity and Keypad Mortise Exit Device with Cylinder Override (2,000 Users) | \$3,357.00 | \$3,410.00 |
| LK8978 ET x Lever Design | | Keypad Mortise Exit Device without Cylinder override (100 Users) | \$2,621.00 | \$2,674.00 |
| G1 LU8978 ET x Lever Design | | Keypad Mortise Exit Device without Cylinder override (2,000 Users) | \$2,768.00 | \$2,821.00 |
| G1 PA8978 ET x Lever Design | * | Proximity ONLY Mortise Exit Device without Cylinder Override (2,000 Users) | \$3,228.00 | \$3,281.00 |
| G1 PK8978 ET x Lever Design | | Proximity and Keypad Mortise Exit Device without Cylinder Override (2,000 Users) | \$3,299.00 | \$3,352.00 |

*Requires SoloPlus for programming.

| 8800 Profile Series with RF Technology – Rim Exit Device | | | | |
|--|---|---|------------|------------|
| G1 TU8877 ET x Lever Design | | RF Actuation Keypad w/Cylinder Override (2,000 Users) | \$2,803.00 | \$2,856.00 |
| G1 TA8877 ET x Lever Design | * | RF Actuation Proximity w/Cylinder Override (2,000 users) | \$3,264.00 | \$3,317.00 |
| G1 TP8877 ET x Lever Design | | RF Actuation Proximity & Keypad w/Cylinder Override (2,000 users) | \$3,331.00 | \$3,384.00 |
| G1 TU8878 ET x Lever Design | | RF Actuation Keypad w/o Cylinder Override (2,000 Users) | \$2,745.00 | \$2,798.00 |
| G1 TA8878 ET x Lever Design | * | RF Actuation Proximity w/o Cylinder Override (2,000 users) | \$3,204.00 | \$3,257.00 |
| G1 TP8878 ET x Lever Design | | RF Actuation Proximity & Keypad w/o Cylinder Override (2,000 users) | \$3,273.00 | \$3,326.00 |

| 8900 Profile Series with RF Technology – Mortise Exit Device | | | | |
|--|---|---|------------|------------|
| G1 TU8977 ET x Lever Design | | RF Actuation Keypad w/Cylinder Override (2,000 Users) | \$3,049.00 | \$3,102.00 |
| G1 TA8977 ET x Lever Design | * | RF Actuation Proximity w/Cylinder Override (2,000 users) | \$3,510.00 | \$3,563.00 |
| G1 TP8977 ET x Lever Design | | RF Actuation Proximity & Keypad w/Cylinder Override (2,000 users) | \$3,579.00 | \$3,632.00 |
| G1 TU8978 ET x Lever Design | | RF Actuation Keypad w/o Cylinder Override (2,000 Users) | \$2,988.00 | \$3,041.00 |
| G1 TA8978 ET x Lever Design | * | RF Actuation Proximity w/o Cylinder Override (2,000 users) | \$3,449.00 | \$3,502.00 |
| G1 TP8978 ET x Lever Design | | RF Actuation Proximity & Keypad w/o Cylinder Override (2,000 users) | \$3,515.00 | \$3,568.00 |

Note: RF FOB must be ordered separate from Exits – See page PS-10.

*Requires SoloPlus for programming.

PS-10 PROFILE SERIES

SARGENT®

STAND ALONE PRODUCTS ACCESSORIES

ASSA ABLOY

USA & Canada Prices Effective June 3, 2019



PCH-P30



PF



52-2551

Qty 1 each = 1 card or Fob – must be ordered in multiples of 25.

| ISO ProxCard II, ProxKey III, iClass 210 | | Price |
|--|--|----------|
| **PCH-P30 | HID ISO ProxCard II Blank white card - 26 Bit Format .031 thick - Minimum order 25 each | \$19.00 |
| **PCH-P30-C | HID ISO ProxCard II Blank white card - Custom - customer requested site code, range of card numbers, bit format - Minimum order 25 each | \$19.00 |
| **PCH-C30 | HID iCLASS 210 Blank white card - 26 Bit Format .031 thick - Minimum order 25 each | \$9.00 |
| **PCH-C30-C | HID iCLASS 210 Blank white card - Custom - customer requested site code, range of card numbers, bit format - Minimum order 25 each | \$9.00 |
| PF | ProxKey - FOB - Minimum order 25 each | \$14.80 |
| *PF-C | ProxKey III - FOB - Custom - customer requested site code or range of fob numbers - Minimum order 100 | \$14.80 |
| 52-2551 | RF FOB (TU/TP/TA) | \$105.00 |

| Micro Prox Tag for Profile Series Proximity Access Control Products | | Price |
|---|---|-------------|
| MPT | MicroProx™ Tag with SARGENT site code - Minimum order 100 each | \$9.30 each |
| *MPT-C | Custom – Customer requested site code or range of fob numbers - Minimum order 100 each | \$9.30 each |

| Accessories | | Price |
|-------------|---|----------|
| ES-G1 | Enrollment Station | \$800.00 |
| CDSOLO1 | SoloPlus™ Access Control Management Software | \$356.00 |
| DTD | Data Transfer Device (includes SoloPlus Software) | \$867.00 |

Receive 50% only and \$25.00 list handling charge per item/order.

*Note: - PF-C and MPT-C receive 50% only and \$25.00 list handling charge per item/order.
 - HID technology allows for prox connectivity to access control systems.
 - For a higher level of security, customer cards or fobs w/unique site codes are available - consult factory

**Note: - ISO ProxCard II, ProxKey III iCLASS 210 are trademarks of HID Corporation
 - Cards with unique site codes, specific segment numbering or bit format

Consult Factory

STAND ALONE PRODUCTS ACCESSORIES PARTS

USA & Canada Prices Effective June 3, 2019

| Additional Accessories | | |
|------------------------|---|------------|
| Part # | Description | Price |
| 3267 | Power Supply (9VDC) w/Wall Plug-In Transformer and Box | \$510.00 |
| 4293 | Wall Prox-Keypad/Card Reader Assy. | \$1,200.00 |
| 10-0469 | Weatherseal Gasket - 10L | \$17.73 |
| 68-1400 | Weatherseal Gasket - 88/8900 | \$14.27 |
| 82-0500 | Weatherseal Gasket - 8200 | \$24.15 |
| 52-0033 | Fire Stop | \$22.30 |
| 52-0034 | Print Paper (6 rolls) for Infrared Portable Printer | \$101.88 |
| 52-0069 | Battery Cover Only – KP | \$13.54 |
| 52-0170 | Profile Set Battery Cover without RF Tech. | \$13.54 |
| 52-0253 | Battery Keeper | \$5.52 |
| 52-0254 | Weatherseal Gasket | \$6.56 |
| 52-0255 | Remote Power - Wall Plug-In Transformer - for replacement | \$55.70 |
| 52-0256 | Remote Power - 12V Gel Cell Battery - Option | \$63.67 |
| 52-0258 | Remote Power - Cable, Power Supply to Power Transformer - for replacement | \$54.10 |
| 52-0344 | RF Tech Battery Keeper | \$33.42 |
| 52-2071 | Remote Unlocking Wire Harness | \$58.90 |
| 52-2299 | Keypad Only | \$194.69 |
| 52-2340 | Outside Escutcheon & Keypad | \$424.54 |
| 52-2393 | Controller Computer Cable Kit - required for SofLink Plus™ w/SofLink PDPTM | \$37.08 |
| 52-2400 | KP10G77 Controller Replacement Kit | \$375.06 |
| 52-2401 | KP8200 Controller Replacement Kit | \$375.06 |
| 52-2418 | 24 Conductor Ribbon Cable | \$33.42 |
| 52-2431 | Proximity Assembly - PA | \$125.16 |
| 52-2432 | Keypad/Proximity Circuit Brd & Harness Assy (LK) (10L, 8200, 88/8900) | \$198.03 |
| 52-2436 | Profile Series Battery holder assy. | \$13.45 |
| 52-2439 | 100(LK) User Keypad Controller Assy (10L) | \$405.06 |
| 52-2440 | 100(LK) User Keypad Controller Assy (8200) | \$405.06 |
| 52-2441 | 100(LK) User Keypad Controller Assy (88/8900) | \$405.06 |
| 52-2498 | Remote Power - 9VDC Power Supply PCB - for replacement | \$394.60 |
| 52-2500 | Remote Power - Remote Unlocking/Hard Power Harness Connection | \$58.90 |
| 52-2509 | RF Tech Battery Cover | \$17.52 |
| 52-2556 | Motor & Housing Assy. For use with motorized ET | \$273.03 |
| 52-2561 | KP88/8900 Controller Replacement Kit | \$375.06 |
| 52-2562 | Ribbon Cable Assy; 20 Conductor | \$33.42 |
| 52-2593 | Keypad Shroud Pack | \$64.26 |
| 52-2704 | Keypad/Proximity Circuit Board & Harness Assy. (G1-LU, G1-PK, G1-TU, G1-TP) | \$472.53 |
| 52-2708 | Keypad/Proximity Circuit Board & Harness Assy. (G1-PA, G1-TA) | \$394.54 |
| 52-2733 | 2,000 (G1-LU) User Keypad Controller Assy (10L) | \$675.10 |
| 52-2734 | 2,000 (G1-PA, G1-PK) User Keypad Controller Assy. (10L) | \$1,050.12 |
| 52-2735 | 2,000 (G1-TU) User Keypad Controller – 10L | \$900.11 |
| 52-2736 | 2,000 (G1-TA, G1-TP) User Keypad Controller – 10L | \$1,275.14 |
| 52-2783 | 2,000 (G1-LU) User Keypad Controller Assy (8200 & 88/8900) | \$675.10 |
| 52-2784 | 2,000 (G1-PA, G1-PK) User Keypad Controller Assy (8200 & 88/8900) | \$1,050.12 |
| 52-2785 | 2,000 (G1-TU) User Keypad Controller – 8200 & 88/8900 | \$900.11 |
| 52-2786 | 2,000 (G1-TA, G1-TP) User Keypad Controller – 8200 & 88/8900 | \$1,275.14 |
| 52-2847 | Conduit (For Weather Protection) | \$13.09 |
| 52-3409 | Forced/Propped Door Harness | \$23.16 |

* Specify finish required when ordering.

PS-12 PROFILE SERIES

SARGENT®

ASSA ABLOY

10-LINE STAND ALONE PRODUCTS PARTS

USA & Canada Prices Effective June 3, 2019

| Part # | Description | Price |
|-----------|--|---------------------|
| * 547 | Retrofit Kit to cover Unican Prep | \$108.00 |
| * 800 | Strike (Standard) | Refer to page BL-47 |
| * 808 | Strike (28 Option) | Refer to page BL-47 |
| 01-0297 | 1/8" Security Socket Screw Key | \$13.86 |
| 01-0803 | Battery Alkaline (C-cell) | \$5.55 |
| 01-0898 | "AA" Batteries | \$2.43 |
| 01-1212 | Security Screw | \$1.09 |
| 10-0019 | Cylinder Spacer (Sargent Standard Cylinder & SC, SE Option) | \$0.64 |
| 10-0312 | Cylinder Retainer (required for lever - standard) - plastic | \$1.56 |
| * 10-0501 | Inside Lever "L" Design - Regular | \$71.00 |
| * 10-0502 | Outside Lever "L" Design - Sargent Standard Cylinder | \$71.00 |
| * 10-0503 | Outside Lever "L" Design - 30 Option | \$71.00 |
| * 10-0523 | Inside Lever "B" Design - Regular | \$71.00 |
| * 10-0524 | Outside Lever "B" Design - Sargent Standard Cylinder | \$71.00 |
| * 10-0525 | Outside Lever "B" Design - 30 Option | \$71.00 |
| * 10-0545 | Inside Lever "P" Design - Regular and 30 Option | \$71.00 |
| * 10-0546 | Outside Lever "P" Design - Sargent Standard Cylinder | \$71.00 |
| * 10-0547 | Outside Lever "P" Design - 30 Option | \$71.00 |
| * 10-0790 | Inside and outside Rose Scalp - 26D - G Rose | \$61.75 |
| * 10-0790 | Inside and outside Rose Scalp - 3, 4, 9, 10, 10B, 10BL, 20D, 26 - G Rose | \$84.09 |
| * 10-0798 | Inside and outside Rose Scalp - 26D - L Rose | \$44.61 |
| * 10-0798 | Inside and outside Rose Scalp - 3, 4, 9, 10, 10B, 10BL, 20D, 26 - L Rose | \$66.89 |
| * 10-2052 | Screw Pack | \$4.69 |
| * 10-2053 | 3 3/4" Backset Latch (23 Option) | \$85.56 |
| * 10-2058 | 5" Backset Latch (25 Option) | \$98.73 |
| * 10-2204 | Inside Lever "J" Design - Regular and 30 Option | \$71.00 |
| * 10-2205 | Outside Lever "J" Design - Sargent Standard Cylinder | \$71.00 |
| * 10-2206 | Outside Lever "J" Design - 30 Option | \$71.00 |
| * 10-2634 | 3/4" Throw (41 Option) latch | \$131.02 |
| 10-2642 | 77 Lockbody (Std, 10, 21, 23, 30, SC, SE, VA, VS Cylinders) | \$316.96 |
| 10-2643 | 77 Lockbody (60, 63, 64 cylinders) | \$316.96 |
| 10-2644 | 77 Lockbody (70, 72, 65-73, 65-73-7P Options Only) | \$316.96 |
| * 10-2875 | Inside Escutcheon Assy - KP | \$642.26 |
| * 10-3015 | I/S Esc. Housing Only (Profile Ser.) | \$295.27 |
| * 10-3016 | O/S Esc. Housing Only (Profile Ser.) | \$295.27 |
| * 10-3020 | I/S Esc. & 100 User Controller - LK | \$670.06 |
| * 10-3026 | O/S Esc. - for Keypad, Keypad/Prox (LK) | \$460.17 |
| 10-3048 | Inside Rose Spring Assy. | \$77.24 |
| 10-3049 | Outside Rose Spring Assy. | \$78.37 |
| * 10-3126 | I/S Esc. & 2,000 User Controller - G1-LU | \$920.32 |
| * 10-3127 | I/S Esc. & Keypad/Prox or Prox Only Controller - G1-PA, G1-PK | \$1,267.85 |
| * 10-3128 | I/S Esc. & 2,000 User Controller - G1-TU | \$1,128.84 |
| * 10-3129 | I/S Esc. & Keypad/Prox or Prox Only Controller (G1-TA, G1-TP) | \$1,476.38 |
| * 10-3130 | O/S Esc. - For Keypad/Prox (G1-LU, G1-PK, G1-TU, G1-TP) | \$728.82 |
| * 10-3131 | O/S Esc. - for Prox. Only (G1-PA, G1-TA) | \$660.34 |
| 10-3170 | 77 Lockbody (SF option) | \$316.96 |
| * 10-3192 | 2 3/4" Backset Latch (Standard, Guarded) | \$59.26 |
| * 52-2300 | Screw Pack | \$29.37 |

* Specify finish required when ordering.

8200 STAND ALONE PRODUCTS TRIM/PARTS

USA & Canada Prices Effective June 3, 2019

| 8200 - Keypad(KP) | | Price |
|-------------------|---------|--|
| Number | Rose | 03/04/09/10/10B/10BE/10BL/14/15/20D/26/26D/BSP/WSP |
| 695LN | LN Rose | |
| 695L | L Rose | refer to ML-113 |

| 8200 - Keypad(KP) & Profile Series Inside Levers | | Price |
|--|--------|--|
| Number | Design | 03/04/09/10/10B/10BE/10BL/14/15/20D/26/26D/BSP/WSP |
| 81-0467 | A-LH | |
| 81-0468 | A-RH | |
| 81-0490 | B | |
| 81-0470 | E | refer to ML-107 |
| 81-0471 | F | |
| 81-0447 | J | |
| 81-0489 | L | |
| 81-0513 | P | |
| 81-0445 | W | |

| 8200 - Keypad & Profile Series Outside Levers | | Price |
|---|--------|--|
| Number | Design | 03/04/09/10/10B/10BE/10BL/14/15/20D/26/26D/BSP/WSP |
| 82-0151 | A-LH | |
| 82-0152 | A-RH | |
| 82-0153 | B | |
| 82-0154 | E | |
| 82-0155 | F | refer to ML-106 |
| 82-0156 | J | |
| 82-0157 | L | |
| 82-0158 | P | |
| 82-0159 | W | |

| 8200 - Keypad(KP) Outside Lever Trim Set | 10BE/26D BSP/WSP | 03/04/10/ 14/15/26 | 09/10B/ 10BL/20D |
|--|---|-----------------------|---------------------|
| Number | | | |
| OS-8276, OS-8277, OS-8278, OS-8279 | Standard Roses: LN, L, x Standard Levers: A*, E, F, W Coastal Roses: CR, TR x Coastal Lever Designs: G, R, S, Y Studio Roses: CO, TO, CR, TR, LN, O x Studio Collection Levers Except for Gramercy, Wooster Square, & Grant Park For Gramercy, Wooster Square, & Grant Park- Add \$138.00 | \$281.00 | \$284.00 \$294.00 |
| | Standard Roses: LN, L x Standard Levers: B, L, P | \$267.00 | \$270.00 \$282.00 |
| | Standard Roses: LN, L x Standard Lever: J | \$225.00 | \$234.00 \$240.00 |

* Specify finish when ordering

| Part # | Description | Price |
|-----------|--|------------|
| * 1KB-1 | Cylinder Rosette (for Size 41 Cylinder) | \$17.00 |
| * 1KB-3 | Cylinder Rosette (for Size 42 Cylinder) | \$17.00 |
| * 90 1/4 | Cylinder Ring (for Size 41 Cylinder) | \$7.72 |
| * 90 3/8 | Cylinder Ring (for Size 42 Cylinder) | \$7.72 |
| 01-0079 | Washer | \$0.85 |
| 01-0297 | 1/8" Security Socket Screw Key | \$13.86 |
| 01-0543 | Spring Grip Fastener (thumbturn) | \$1.63 |
| 01-0803 | Battery Alkaline ("C" Cell) | \$5.55 |
| 01-0844 | Washer (thumbturn) | \$0.62 |
| 01-0898 | Battery Alkaline ("AA" cell) | \$2.43 |
| * 01-1019 | Lockbody Screws for Metal #12-24 x 1/2" FL HD | \$0.78 |
| * 01-1028 | Outside Front #8-32 x 1/4" FL HD Screw | \$0.77 |
| * 01-1119 | #8-32 x 1 1/2" Flat Head Screw | \$1.45 |
| 01-1157 | #8-32 x 1 1/4" Phillips Pan Head Screw | \$0.31 |
| 01-1174 | Lever Handle Screw - B, J, L, P, & W Levers | \$2.78 |
| 01-1212 | Security Screw | \$1.09 |
| 01-1472 | Lever Handle Screw -A, E, & F Levers | \$2.78 |
| 01-1495 | #8-32 x 5/8" Machine Screw | \$0.85 |
| 01-1500 | Fire Stop Screws #8 x 1/2" Type "AB" Ph Pn Hd Self Tap | \$0.35 |
| 01-2299 | Lockbody Screws for Wood #12 x 1 1/4" FL HD | \$0.43 |
| * 01-4388 | #8-1" Phillips Flat Head Screw | \$1.01 |
| 13-0140 | Compression Spring | \$2.04 |
| 52-0159 | Cover Plate for ILCO Prep | \$92.06 |
| 52-2057 | Screw Pack | \$44.97 |
| 52-3412 | Harness (mates to Dorm Room Controller) | \$31.21 |
| 52-3413 | Dorm Room Mortise Controller Assembly (PA/PK) | \$1,059.84 |

* Specify finish required when ordering.

PS-14 PROFILE SERIES

SARGENT®

8200 STAND ALONE PRODUCTS TRIM/PARTS

ASSA ABLOY

USA & Canada Prices Effective June 3, 2019

| Part # | Description | Price |
|----------|---|------------|
| 77-0168 | Thrubolts #8-32 x 1 7/8" Flat Head Screw | \$1.57 |
| 77-0772 | Spindle (thumbturn) | \$7.60 |
| *77-4236 | Screw Pack | \$5.48 |
| 81-0723 | Post | \$1.90 |
| *82-0081 | Outside Front - 78 & 79 functions | \$48.18 |
| *82-0084 | Outside Front - 76 & 77 functions | \$48.18 |
| 82-0184 | Cap Nut | \$7.10 |
| 82-0347 | I/S Spring / O/S Spring (part # for 1 spring) | \$0.85 |
| 82-0368 | I/S Spindle / O/S Spindle (part # for 1 spindle) | \$9.30 |
| *82-0492 | I/S Esc. Housing Only without Thumbturn | \$325.40 |
| *82-0493 | O/S Esc. Housing Only without cylinder hole | \$325.40 |
| *82-0494 | I/S Esc. Housing Only w/Thumbturn | \$325.40 |
| *82-0495 | O/S Esc. Housing Only with cylinder hole | \$325.40 |
| 82-0507 | Thumbturn | \$30.66 |
| 82-3082 | Plate Assy | \$9.30 |
| 82-3088 | Inside Adapter & Plate Assy | \$25.36 |
| *82-3729 | Inside Escutcheon & Plug Assy (KP8278/KP8279) | \$671.49 |
| *82-3730 | Inside Escutcheon & Turn Lever Assy (KP8276/KP8277) | \$671.49 |
| *82-3837 | I/S Esc. with Thumbturn and 100 user Controller (LK) | \$696.03 |
| *82-3838 | I/S Esc. without Thumbturn and 100 user Controller (LK) | \$696.03 |
| *82-3846 | O/S Esc. with Cyl. Hole & Keypad (LK) | \$477.99 |
| *82-3847 | O/S Esc. without Cyl. Hole & Keypad (LK) | \$477.99 |
| *82-4182 | I/S Esc. with Thumbturn and 2,000 user Controller (G1-LU) | \$955.97 |
| *82-4183 | I/S Esc. without Thumbturn and 2,000 user Controller (G1-LU) | \$955.97 |
| *82-4184 | I/S Esc. with Thumbturn Prox/Keypad Controller (G1-PA, G1-PK) | \$1,316.94 |
| *82-4185 | I/S Esc. without Thumbturn Prox/Keypad Controller (G1-PA, G1-PK) | \$1,316.94 |
| *82-4186 | I/S Esc. with Thumbturn & 2,000 User Controller (G1-TU) | \$1,172.55 |
| *82-4187 | I/S Esc. without Thumbturn & 2,000 User Controller (G1-TU) | \$1,172.55 |
| *82-4188 | I/S Esc. with Thumbturn & Keypad/Prox or Prox Only Controller (G1-TA, G1-TP) | \$1,533.56 |
| *82-4189 | I/S Esc. without Thumbturn & Keypad/Prox or Prox Only Controller (G1-TA, G1-TP) | \$1,533.56 |
| *82-4190 | O/S with Cyl. Hole Keypad/Prox (G1-LU, G1-PK, G1-TU, G1-TP) | \$760.99 |
| *82-4191 | O/S without Cyl. Hole Keypad/Prox (G1-LU, G1-PK, G1-TU, G1-TP) | \$826.01 |
| *82-4192 | O/S Esc. with Cyl. Hole & Prox Only (G1-PA, G1-TA) | \$685.92 |
| *82-4193 | O/S Esc. without Cyl. Hole & Prox Only (G1-PA, G1-TA) | \$685.92 |

* Specify finish required when ordering.

8800/8900 STAND ALONE PRODUCTS TRIM/PARTS

USA & Canada Prices Effective June 3, 2019

| 88/89 - Keypad(KP) & Profile Series ET Trim Set | | | 03/04/09/10/10B/10BE/10BL/ 14/15/20D/26/26D/BSP/WSP | |
|---|---------------|--|--|---------------------------------------|
| Number | Exit Function | Description | | |
| 777 ET x Lever Design | 8977 | Standard Lever Designs: A, B, E, F, J, L, P, W | | |
| 778 ET x Lever Design | 8978 | Coastal Lever Designs: C, G, R, S, Y | | \$842.00 |
| 777-8 ET x Lever Design | 8877 | Studio Collection Levers Except for Gramercy, Wooster Square, & Grant Park | | |
| 778-8 ET x Lever Design | 8878 | For Gramercy, Wooster Square, & Grant Park – Add \$160.00 | | |
| Consult catalog for available lever designs, finishes, & ordering information | | | | |
| 8900 - Keypad(KP) & Profile Series Mortise Lockbodies | | | 03/04/09/10/10B/10BE/10BL/ 14/15/20D/26/26D/BSP/WSP | |
| Number | Exit Function | | | |
| 977 | 8977 | | | \$683.00 |
| 978 | 8978 | | | |
| 88/89 - Keypad Upgrade Kits to Convert to Profile Series | | | 10BE/26D/ BSP/WSP | 03/04/09/10/10B/ 10BL/14/15/20D/26 |
| Number | Kit Type | Description | | |
| 231LK | 1-Pack | Keypad w/Cyl. Override (100 users) | \$712.00 | \$766.00 |
| 231G1LU | 1-Pack | Keypad w/Cyl. Override (2,000 users) | \$989.00 | \$1,032.00 |
| 231G1PA | 1-Pack | Prox Only w/Cyl. Override (2,000 Users) | \$1,372.00 | \$1,415.00 |
| 231G1PK | 1-Pack | Keypad & Prox w/Cyl. Override (2,000 Users) | \$1,423.00 | \$1,468.00 |
| 88/89 - Keypad Upgrade Kits to Convert to Profile Series | | | 10BE/26D/ BSP/WSP | 03/04/09/10/10B/ 10BL/14/15/20D/26 |
| Number | Kit Type | Description | | |
| 233LK | 3-Pack | Keypad w/Cyl. Override (100 users) | \$1,909.00 | \$2,071.00 |
| 233G1LU | 3-Pack | Keypad w/Cyl. Override (2,000 users) | \$2,768.00 | \$2,907.00 |
| 233G1PA | 3-Pack | Prox Only w/Cyl. Override (2,000 Users) | \$3,916.00 | \$4,052.00 |
| 233G1PK | 3-Pack | Keypad & Prox w/Cyl. Override (2,000 Users) | \$4,075.00 | \$4,211.00 |
| 88/89 - Keypad Upgrade Kits to Convert to Profile Series | | | 10BE/26D/ BSP/WSP | 03/04/09/10/10B/ 10BL/14/15/20D/26 |
| Number | Kit Type | Description | | |
| 231G1TU | 1-Pack | Keypad w/Cyl. Override (2,000 users) | \$1,266.00 | \$1,307.00 |
| 231G1TA | 1-Pack | Prox Only w/Cyl. Override (2,000 users) | \$1,627.00 | \$1,669.00 |
| 231G1TP | 1-Pack | Keypad & Prox w/Cyl. Override (2,000 Users) | \$1,676.00 | \$1,719.00 |
| 88/89 - Keypad Upgrade Kits to Convert to Profile Series | | | 10BE/26D/ BSP/WSP | 03/04/09/10/10B/ 10BL/14/15/20D/26 |
| Number | Kit Type | Description | | |
| 233G1TU | 3-Pack | Keypad w/Cyl. Override (2,000 users) | \$3,612.00 | \$3,743.00 |
| 233G1TA | 3-Pack | Prox Only w/Cyl. Override (2,000 users) | \$4,690.00 | \$4,820.00 |
| 233G1TP | 3-Pack | Keypad & Prox w/Cyl. Override (2,000 Users) | \$4,839.00 | \$4,967.00 |

PS-16 PROFILE SERIES

SARGENT®

8800/8900 STAND ALONE PRODUCTS TRIM/PARTS

ASSA ABLOY

USA & Canada Prices Effective June 3, 2019

| Part # | Description | Price |
|----------|---|------------|
| 649 | 12-8800 Strike | \$81.34 |
| 908 | 8900 Strike | \$32.96 |
| C908 | 12-8900 Strike – Specify hand when ordering | \$34.59 |
| 01-0297 | 1/8" Security Socket Screw Key | \$13.86 |
| 01-0898 | Battery Alkaline ("AA" Cell) | \$2.43 |
| *01-1119 | #8-32 x 1-1/2" Flat Head Machine Screw | \$1.45 |
| 01-1212 | Security Screws | \$1.09 |
| 01-1500 | Fire Stop Screws #8 x 1/2" Type "AB" PH Pn Hd Self Tap | \$0.35 |
| 01-4451 | Chassis Thru Bolts - 1/4-20 x 2-3/8" Flat Head Machine Screws | \$1.68 |
| 13-0074 | #12-24 x 2-1/8" Flat Head Machine Screw | \$0.66 |
| 52-0086 | Inside Mounting Bracket | \$3.19 |
| *52-0087 | KP-88/8900 I/S Esc | \$194.30 |
| 52-0175 | Inside Escutcheon End Cap | \$3.44 |
| 52-0176 | Outside Escutcheon End Cap | \$3.44 |
| 52-0263 | ET Trim Weather Seal Gasket | \$10.92 |
| 52-2022 | Tool Pack for 8977 | \$48.50 |
| 52-2211 | Tool Pack for 8978 | \$48.50 |
| *52-2302 | Inside Escutcheon/Controller Assy – KP | \$664.36 |
| 52-2303 | Screw Pack | \$39.74 |
| 52-2425 | Screw Pack | \$24.99 |
| 52-2460 | Inside Escutcheon Assy. & 100 User Controller (LK) | \$688.65 |
| 52-2474 | Outside Escutcheon Assy. (Keypad -LK) | \$472.92 |
| *52-2833 | Inside Escutcheon Assy. & 2,000 User Controller (G1-LU) | \$945.83 |
| *52-2834 | Inside Escutcheon Assy. & 2,000 User Controller (G1-PA, G1-PK) | \$1,303.00 |
| *52-2835 | Inside Escutcheon Assy. & Keypad/Prox or Prox Only 2,000 User Controller (G1-TA, G1-TP) | \$1,517.30 |
| *52-2836 | Inside Escutcheon Assy. & 2,000 User Controller (G1-TU) | \$1,160.13 |
| *52-2838 | Outside Escutcheon Assy. (Keypad/Prox –G1-LU, G1-PK, G1-TU, G1-TP) | \$752.92 |
| *52-2839 | Outside Escutcheon Assy. (Keypad – Prox Only – G1-PA, G1-TA) | \$678.65 |
| 52-5654 | EcoFlex ET Harness KP, G1.5, LK | \$13.58 |
| *68-0406 | 8800 Chassis Cover | \$220.13 |
| *68-0407 | 8900 Chassis Cover | \$220.13 |
| 68-1396 | Inside Escutcheon Housing ONLY | \$336.50 |
| 68-1397 | Outside Escutcheon Housing ONLY | \$311.16 |
| 68-2172 | Chassis Assy LHRB (12-) 8900 | \$526.04 |
| 68-2173 | Chassis Assy RHRB (12-) 8900 | \$526.04 |
| 68-4261 | Chassis Assy LHRB/RHRB – 8800 | \$466.73 |
| 68-4263 | Chassis Assy LHRB/RHRB – 12-8800 | \$454.47 |
| 77-0685 | Escutcheon Thru Bolts | \$6.57 |

* Specify finish required when ordering.



Copyright © 2002-2019 Sargent Manufacturing Company, an ASSA ABLOY Group company.
All rights reserved. Reproduction in whole or in part without the express written permission
of Sargent Manufacturing Company is prohibited.

**For USA Contact us at: 800-727-5477
or visit www.sargentlock.com**

**For Canada contact us at: 800-461-3007
or visit www.assaabloydss.ca**