



MARKSUSA

2019 Price List

Mortise Locksets

**Cylindrical, Tubular & Electronic
Access Control Locksets**

Exit Devices



July 2019

MORTISE LOCKSET PRICE LIST • EFFECTIVE SEPTEMBER 2016

TABLE OF CONTENTS

Required Information	6
Backset	6
Door Thickness	6
Handing	6
Mounts & Displays	6
Mortise Lock Trim Information	7
Handleset Trim	7
Leverset/Knobset Trim	7
How To Order Mortise Locksets & Handlesets	8-10
How To Order Instructions & Examples	8
1. Series	9
2. Plates/Roses/Handlesets	9
3. Knob/Lever	9
4. Mortise Functions	9
5. Finishes	9
6. Options	10
Plate Designs	11-27
Barrier - BA	11
Classic - CL	12-13
Capitol - CP	14-15
Crown - CR	16-17
Drake - DR	18-19
Davos - DV	20-21
Madison - MA	22-23
New Yorker - NY	24-25
Towne - TN	26-27
Rose Designs	28-29
Rose with Ring - RR	28-29
Plain Rose - RW	28-29
Small Rose with Ring - RQ	28-29
Small Rose - RS	28-29
Square Rose - RX	28-29
Square Rose - RK	28-29
Square Rose - RL	28-29
Handleset Designs	30-31
Crown - CR	30
Towne - TN	32
Ornamental Iron	32-33
Series 21 Unilock™	32
Series 22	32
Series 9215 Unilock™	32
Series 9225	32
Series 9257 Unilock™	32
Series 9267	32
THINLINE® Series 2750	32
Knob & Lever Kits	33
Accessories	33
Cylinders	33

MORTISE LOCKSET PRICE LIST

Mortise Parts & Trim	34-46
Mortise Lock Bodies Series 4 & 45	34
Mortise Lock Bodies Series 5 & 55	35
Mortise Lock Bodies Series 6 & 8	36
Mortise Lock Bodies Series 7 & 9	37
Mortise Deadlocks Series 31, 2, 3, 5 & 55	38
Mortise Lockset Functions	39-40
Mortise Lock Parts: Knob/Lever Rose Kits	41
Mortise Lock Parts: Dummy Cylinder, Collars & Turnpieces, Strikes, Spindles	42
Trim Lock Parts: How to Order	43
Trim Lock Parts: Plate/Rose Design	44
Trim Lock Parts: Knob/Lever Design	45
Trim Lock Parts: Handle Design	46
Mortise Door Accessories	46

CYLINDRICAL & TUBULAR LOCKSET PRICE LIST

How To Order Cylindrical Locksets	47
How To Order Example For Cylindrical Locksets	47
1. Series	47
2. Cylindrical Functions	47
3. Finishes	47
4. Options	47
Cylindrical Locksets	48-51
80 Line Grade 1 Cylindrical Knobsets	48
10 Line Grade 2 Cylindrical Knobsets	49
95 Line Grade 1 Cylindrical Survivor Series Leversets	50
75 Line Grade 2 Cylindrical Survivor Series Leversets	51
Residential Interior Cylindrical Locksets	52
1120 Series Grade 2 Knobsets (<i>cylindrical knobsets for interior use</i>)	52
230 Series Knobsets (<i>cylindrical knobsets for interior use</i>)	52
Cylindrical Lock Accessories	53
Latches, Strikes, Spacer Rings, Etc.	53
Marks Survivor Series Lock Installation Tool J295	53
Cylinders, Cylindrical Lock Tailpieces, Cylindrical IC Core Tailpieces	53
How to order example for Cylindrical Lock Cylinders & Tailpieces	53
Cylindrical Knob/Lever Functions	54
How To Order Tubular Locksets	55
How To Order Example For Tubular Locksets	55
1. Series	55
2. Roses	55
3. Knob/Lever	55
4. Tubular Function	55
5. Finishes	55
6. Options	55
Tubular Knob & Lever Functions	55
Rose Designs	56
Rose with Ring - RR	56
Plain Rose - RW	56
Small Rose with Ring - RQ	56
Small Rose - RS	56
Square Rose - RX	56
Square Rose - RK	56
Square Rose - RL	56
Residential Interior Tubular Locksets	57
150 Series American Lever (<i>tubular leversets for interior use</i>)	57
250 Series Crescent Lever (<i>tubular leversets for interior use</i>)	57
450 Series Titan Lever (<i>tubular leversets for interior use</i>)	57
Tubular Lockset Accessories	58
Strikes, Latches, Support Housing	58
Turnpieces	58
Latches & Cylindrical Cartridge	58
How To Order For Defender Locksets	59
How To Order Example For Defender Locksets	59
1. Series	59
2. Tubular Functions	59
3. Finishes	59
4. Options	59
Deadbolt/Deadlatch Functions	59

CYLINDRICAL & TUBULAR LOCKSET PRICE LIST

Defender Series Tubular Deadbolts & Cylindrical Cartridge Deadlatches	60
130 Series Grade 1 Defender Tubular Deadbolts	60
145 Series Grade 1 Defender Cylindrical Cartridge Deadlatches	60
Defender Series Accessories	61
Strikes, Latches & Spacers	61
Latches & Cylindrical Cartridge	61
Tailpieces & Cylinders	61
i-Qwik/i-Que Electronic Access Control Locksets	62-64
i-Qwik LITE ² Series Electronic Access Control & How To Order Example	62
i-Qwik/i-Que Series Options	63
i-Qwik/i-Que Series Accessories, Tailpieces & Cams	64
Request To EXit (REX) Leversets & Electrified Locksets	65-66
Request To EXit (REX) Cylindrical Grade 1 Leversets (EA195, EA295, EA395 & EA495)	65
How To Order Example For REX Leversets	65
195, 295, 395 & 495 Series Grade 1 Electrified Cylindrical Leversets	66
5 Series Grade 1 Electrified Mortise Lockset	66
Gate Locks	67
Swinging Gate Locks	67
Sliding Gate Locks	67
Parts	67
Custom Lockset Division	68-70
Series HA113 Housing Authority Mortise Lockset	68
Series LA318GJ Maximum Security Mortise Lockset	69
Series BE101 & LA3118	70
Institutional Life Safety Mortise Locksets	71-75
Series 195BH D-Lig Slide Cylindrical Lockset	71
Series 5BH D-Lig Slide Mortise Lockset	72
Series 195SS Institutional Life Safety Cylindrical Lever Lockset	73
Series 5SS55 & 5SS19 Institutional Life Safety Mortise Knob & Lever Locksets	74
Series 180SS Institutional Life Safety Cylindrical Knobsets & Locksets	75
Series 31SS55 Institutional Life Safety Mortise Deadlock	75
Hospital Locksets	76
Series 180PD Cylindrical Push/Pull Paddlelocks	76
Series 5PD & 55PD Mortise Push/Pull Paddlelocks	76
Mortise Lock Cylinders, Parts & Cams	77
Cylinders, IC Core Cylinder Housings, Cylinder Cams	77
How To Order For Mortise Lock Cylinders	77
KEYS & KEYING	78
HI-SECURITY™ Cylinders	79-85
HI-SECURITY™ Cylinders: NON-UL	79
HI-SECURITY™ Cylinders: UL 437	80
Security-Mate™ Cylinders, Special Application Cylinders	81
How To Order HI-SECURITY™ Cylinders and Keys	82
Keys, Cams & Tailpieces	83
Parts List	84

DOOR CLOSERS & PANIC DEVICES PRICE LIST

Exit Devices85-89
Series M9900 Exit Device - Rim Mount	85
Series M9900 VR Exit Device - Surface Vertical Rod	85
Series M9900 Exterior Trim	86
Series M9900 Cams & Tailpieces	86
Series M8800 Exit Device	86
Series M195	87
Series M9300 Exit Device - Mortise	87
Electric Latch Retraction with Simultaneous Dogging	88
Exit Alarm	88
Electric Frame Actuator	89
Electric Dogging	89
Delayed Egress	90
M9900 LITE	90
Power Transfer Hinges & Loops	91
Touchless Exit Switch	93
How To Order Door Closers & Panic Devices	93
NEW! ArchiTech™ Series Networx Locks94-95

Marks USA Antimicrobial finish

Peace of mind for your hardware application when protected against GERMS and MOLD using Stericoat AM. Marks USA antimicrobial finish is recommended for hospitals, assisted living facilities, schools and childcare facilities. **Use Code - AM**

Lifetime Mechanical Limited Warranty: MARKS USA warrants that its products are free from defects in materials and workmanship. This warranty is limited to the lifetime of the door on which our lock is installed. In the event our product does not conform to this warranty, MARKS USA will repair or replace the product free of charge. This warranty does not cover defects or damage arising from improper installation, lack of or improper maintenance, improper storage, shipping and handling, ordinary wear and tear, misuse, abuse, accident, unauthorized service, or use with unauthorized non-MARKS products or parts. We reserve the right to make changes in materials, components or manufacturing methods. Liability under all warranties expressed or implied is limited to replacement of the defective goods. This warranty does not cover nor provide for the reimbursement or payment of incidental or consequential damages. Additionally, the company will not warrant ANSI A156.2 Grade 2 lever product installed in educational facilities and student housing.

2 Year Electronic Limited Warranty: MARKS USA warrants to the original purchaser that its products are free from defects in materials and workmanship so long as they occupy the premises.

In the event our product does not conform to this warranty, MARKS USA will repair or replace the product free of charge at its sole discretion. This warranty does not cover defects or damage arising from improper installation, lack of or improper maintenance, improper storage, shipping and handling, improper application or specification, ordinary wear and tear, misuse, abuse, accident, improper voltage, unauthorized service, or use with unauthorized non-MARKS products or parts. We reserve the right to make changes in materials, components or manufacturing methods. Liability under all warranties expressed or implied is limited to replacement of the defective goods. This warranty does not cover nor provide for the reimbursement or payment of incidental or consequential damages or any shipping charges related to exercising of this warranty.

Lifetime Finish Limited Warranty: MARKS USA Locksets with the "3E" finish will be warranted to the original user against tarnishing as long as the user occupies the residential premises upon which the lockset was originally installed. Locksets with this finish, used in commercial applications will be limited to two years. This warranty does not cover scratches, abrasion, abused or misused products. Upon return of a defective product to Marks USA, we will, at our sole discretion, either replace the product or refund the purchase price in exchange for the product.

Due to climatic conditions, chemical or abrasive actions, other finishes are excluded from this warranty. This warranty does not cover nor provide for the reimbursement or payment of incidental or consequential damages arising from the sale of the product.

Terms & Conditions:

TERMS: Net 30

FREIGHT: Prices are F.O.B. Amityville, New York. Freight allowed on shipments over \$7000 net invoice value within Continental U.S.

RETURNED GOODS: Goods may not be returned without a Returned Goods Authorization (RGA) and are subject to a restocking charge. RGA label must be on all cartons.

MINIMUM CHARGE: Orders for less than \$250 net invoice are subject to a \$25 handling charge.

MINIMUM SALES VOLUME: The company reserves the right to discontinue direct sales to any customer who does not meet the minimum annual sales requirements during any 12 month period. Minimum annual sales volume is determined on the basis of accepted orders during each applicable year. All orders are acknowledged. It is the customers responsibility to check accuracy of the acknowledgment when received.

ArchiTech, Networx, iLock, LocDown, LifeSaver and Hi-Security are trademarks of Marks USA, a division of Napco Security Technologies. All other trademarks listed are properties of their respective companies.

Effective Septemeber 2016. All prices published are suggested list prices in US Dollars. Some specifications are preliminary and subject to change without prior notice. Not responsible for typographical errors. Marks USA is a Division of Napco Security Technologies, Inc. (NASDAQ:NSSC) © Marks USA, 9.16

BACKSET - Required Information

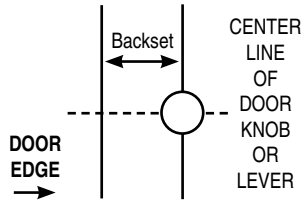

DOOR THICKNESS - Required Information

STANDARD DOOR THICKNESS RANGE:
 Mortise locksets: 1-3/4"
 Cylindrical locksets: 1-5/8" through 1-7/8"
 Ornamental locksets: 1" through 1-1/4"
 Tubular locksets: 1-3/8" through 1-3/4"
 Other door thickness: **Consult factory**

SPECIFY:
 Door thickness (A)
 Lock location (B)

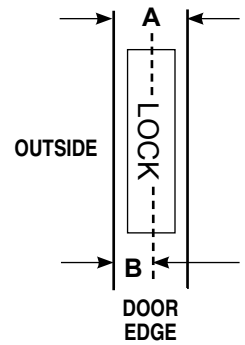

HANDING - Required Information

All locksets supplied 1/2 (LH) and 1/2 (RH) unless otherwise specified

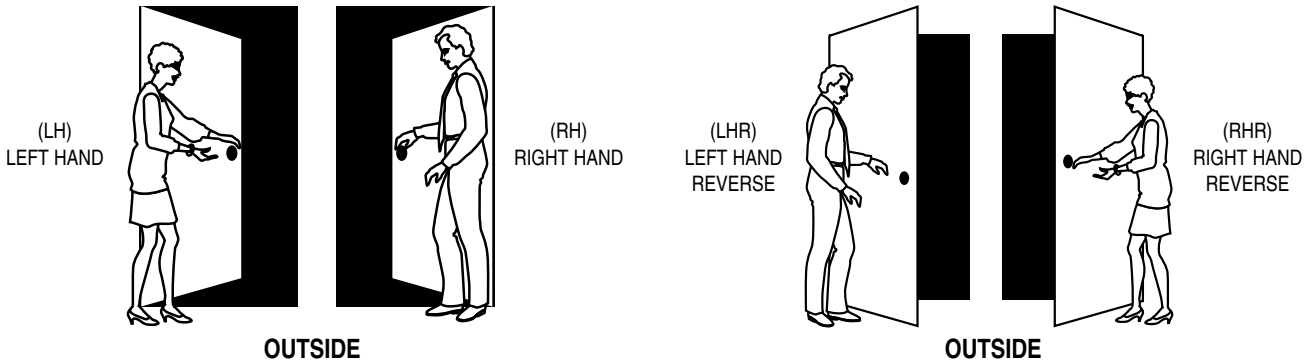

MOUNTS & DISPLAYS AVAILABLE, CONSULT FACTORY



MORTISE LOCK TRIM INFORMATION

HANDLESET TRIM

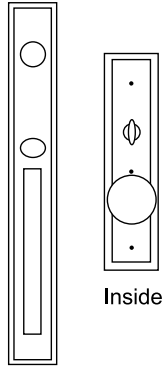

Outside

Inside

**ENTRANCE
Cylinder/Turnpiece**

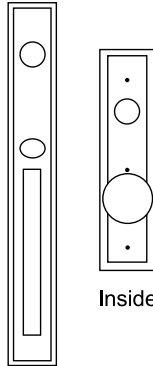

Outside

Inside

**ENTRANCE
Double Cylinder**

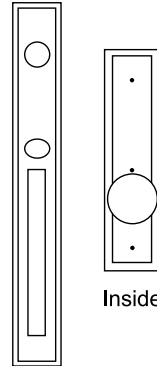

Outside

Inside

**DUMMY TRIM
Both Sides**

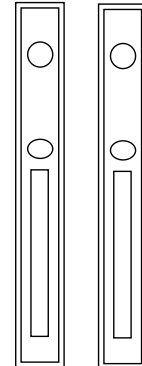

Outside

Inside

**HANDLE SET
With Ext. &
Int. Handle**

LEVERSET/KNOBSET TRIM

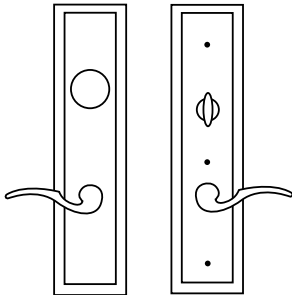

Outside

Inside

**ENTRANCE
Cylinder/Turnpiece**

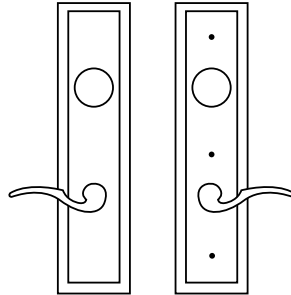

Outside

Inside

**ENTRANCE
Double Cylinder**

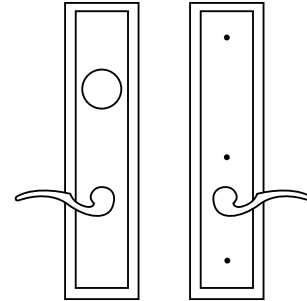

Outside

Inside

OFFICE/CLASSROOM

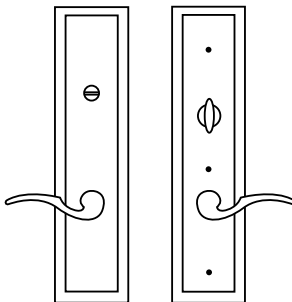

Outside

Inside

PRIVACY

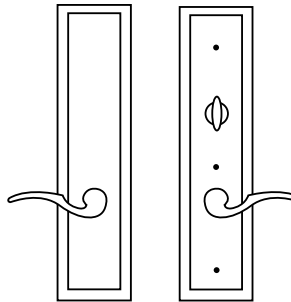

Outside

Inside

EXTERIOR/PATIO

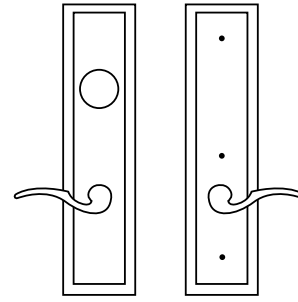

Outside

Inside

**DUMMY TRIM
Both sides**

*Dummy cylinder optional (F17)

How To Order MORTISE LOCKSETS & HANDLESETS

1. Select type of lockset.
2. See corresponding pages in the catalogues for information regarding this type of lock.
3. Create the part number for your lock by selecting the information from fields 1 through 6.
Please note dummy trim is Series "0".
4. Options must be listed in Alpha - Numeric order.
5. Note that if Part Number is over 15 characters, it becomes a special number with the option field *1.
(Your options will then be listed separately.)
Please note the standard (default) features of each lock - they do not need to be selected in the options section.
6. Please indicate keying detail or special instructions on each item ordered.
7. Door Templates are available on the website @ www.marksusa.com/support/templates

How To Order Example for Mortise Locksets	7	NY	10	A	/	3	—	G3
	1. Lock Series	2. Plate/Rose Design	3. Knob/Lever Design	4. Marks Function	Slash	5. Finish	Dash	6. Options

How To Order Example for Rose Design	5	RW	92	N	/	10B	—	D1
	1. Lock Series	2. Plate/Rose Design	3. Knob/Lever Design	4. Marks Function	Slash	5. Finish	Dash	6. Options

How To Order Example for Handlesets	6	CB	60	AC	/	15	—	G3
	1. Series	2. Handleset Design	3. Interior Knob/Lever Design	4. Marks Function	Slash	5. Finish	Dash	6. Options

How To Order Example for Ornamental Iron	9215	AC	/	15	—	G3
	1. Series	2. Marks Function	Slash	3. Finish	Dash	4. Options

How To Order Example for Mortise Lock Bodies	55	JM	/	26D	—	T
	1. Series	2. Marks Function	Slash	3. Finish	Dash	4. Options

How To ORDER MORTISE LOCKSETS & HANDLESETS

1 SERIES	
Dummy Trim	0
Dummy Trim Handlesets Only	00
Mortise Locks	4, 45, 5, 55, 6, 7, 8, 9
Mortise Deadlocks	31, 2, 3

2 PLATES/ROSES/HANDLESETS		
PLATES		DESIGN
Barrier		BA
Classic		CL
Capitol		CP
Crown		CR
Drake		DR
Davos		DV
Madison		MA
New Yorker		NY
School		LA
Towne		TN
ROSES		DESIGN
9602-R	Rose with ring 2-9/16" dia.	RR
9602	Plain rose 2-9/16" dia.	RW
5602-R	Small rose with ring 2-1/4" dia.	RQ
5602	Small rose 2-1/4" dia.	RS
7602	Square rose 2-9/16"	RX
7607	Square forged rose 2-9/16"	RK
HANDLESETS		DESIGN
Crown		CR
Towne		TN

3 KNOB/LEVER		
KNOBS	DESIGN	
1153	Round, wrought	10
1253	Ball, wrought	20
9631	Ball, forged	30
9609	Eclipse, forged	60
LEVERS	DESIGN	
5642	Stanhope	44
5657	Brompton	55
5662	Monaco	57
5672	Towne	72
5677	Maxwell	77
5678	Omni	78
5682	Plaza	82
5683	Dayton	83
5686	Crescent	86
5692	American	92
5696	Titan	96

4 MORTISE FUNCTIONS		
MARKS FUNCTION:		
KEYED SINGLE CYLINDER, NO DEADBOLT		
	ANSI #	
D	OFFICE/VEST.	
DW	VESTIBULE	
E	OFFICE	F04
EW	STOREROOM	F07
EX	EXIT	F31
J	CLASSROOM	F05
JM	HOSPITAL	F06
JR	HOSPITAL	F06
GL	INST PRIVACY	F26
EN	STOREROOM	
DN	STOREROOM	
EL	ELECTRICALLY LOCKED	
EU	ELECTRICALLY UNLOCKED	
KEYED SINGLE CYLINDER, WITH DEADBOLT		
	ANSI #	
A	ENTRANCE	F08,
F10		
B	ENTRANCE	F21
F	DORMITORY	F12
FS	DORMITORY	
FW	DORMITORY	F13
FD	APARTMENT	F20
H	HOTEL	F15
LH	SPECIAL PRIVACY	
KEYED DOUBLE CYLINDER, NO DEADBOLT		
	ANSI #	
G	ENTRANCE	F09
GC	INTRUDER LATCHBOLT	F32
GG	CLASSROOM SECURITY	
GR	CLASSROOM SECURITY w/	
HOLDBACK		
WW	INSTITUTION	F30
KEYED DOUBLE CYLINDER, WITH DEADBOLT		
	ANSI #	
AC	ENTRANCE	F35
C	STOREROOM	F14
FC	INTRUDER DEADBOLT	F34
FA	DORMITORY	F11
FX	DORMITORY	F33
SO	STOREROOM	F25
KEYLESS		
	ANSI #	
N	PASSAGE	F01
L	BATHROOM	F02
LF	PRIVACY	F19
LJ	PRIVACY	F22
DUMMY TRIM		
	ANSI #	
DI	DUMMY TRIM INSIDE	
DO	DUMMY TRIM OUTSIDE	
DT	FULL DUMMY TRIM	



5 FINISH		
MARKS		ANSI #
US 3	Polished Brass, Clear Coated	605
US 3E	Polished Brass "PVD"	605E
US 4	Satin Brass, Clear Coated	606, 606E
US 5	Antique Brass, Clear Coated	609, 609E
US 10E	Satin Bronze "PVD"	612E
US 10	Satin Bronze, Clear Coated	612
US 10B	Dark Bronze, Clear Coated	613E
US 14	Bright Nickel Plating, Clear Coated	614
US 15	Satin Nickel	619, 619E
US 19	Flat Black, Powder Coated	622, 622E
US 20A	Dark Oxidized Statuary Bronze, Clear Coated	624
US 26	Polished Chrome, Plated	625
US 26D	Satin Chrome, Plated	626
US 26E	Satin Chrome, Powder Coat	626E
US 32	Polished Stainless Steel	629
US 32D	Satin Stainless Steel	630
AM	Antimicrobial Finish	AM, +40



FINISH DESIGNATIONS	
Split Finish Designation	
Marks USA Antimicrobial finish - Code: AM	
Split Finish: Exterior one finish/interior one finish designate by an "X"	
Ex: 4TN57A/3Ex15-F3	
Exterior trim 3E Interior Trim US 15	
Combination Finish Designation	
Combination Finish:	
Alternating different finishes on same side of trim designate by a "/" between finishes	
Ex: 4TN57A/3E/15-F3	
Exterior and Interior trim 3E	
US 15 cylinder, turnpiece & lever.	





How To ORDER MORTISE LOCKSETS & HANDLESETS

6			OPTIONS										
LOCK FRONT			CODE	PRICE	DOOR THICKNESS		CODE	PRICE	ELECTRIFIED		CODE	PRICE	
1-1/16" x 8"	Q	28			50 mm (2")	D1	NC		24V	H1			
1-1/16" x 5-5/8"	R	29			57 mm (2-1/4")	D2	45		12V	H2			
1-1/16" x 7-5/8"	T	29			60 mm (2-3/8")	D3	45		Electrically locked	H9			
1-1/4" x 10"	U	112			1-3/4"	D4	NC		Electrically unlocked	H10			
1" x 7-3/4"	V	28			1-3/8"	D5	NC		STRIKE				
1" x 7-1/8"	W	NC			1" - 1-1/4"	D6	NC			CODE	PRICE		
1-1/4" x 8"	X	26			2" - 2-1/4"	D7	45		4-7/8" ASA strike	S1	14		
1-1/4" x 8-5/8"	Y	112			1-1/4" - 1-1/2"	D8	NC		Straight lip strike	S2	4		
1" x 8"	Z	26			Over 3"	D9	667		2-3/4" "T" strike	S3	NC		
TRIM MODIFICATIONS			CODE	PRICE					3-5/8" x 1-1/4" Security strike	S4	12		
Tactile knob/lever, coated ext. only	A1	62			63.5 mm (2-1/2")	D10	72		2-1/4" Curved lip strike	S5	NC		
Emergency coinkey	A2	29			75 mm (3")	D11	93		4-7/8" Strikes: 1 Left / 1 Right	S6	14		
Tamper-proof screws	A3	15			72 mm (2-13/16")	D12	93		Strike with 1-1/2" lip	S7	17		
Tactile knob/lever, knurled	A4	62			2-3/4"-3"	D14	309		Radius corner strike	S8	NC		
Handicapped turnpiece	A5	19			LATCH		CODE	PRICE	4035-1 strike	S9	NC		
Hotel indicator	A6	45			Solid latch	E1	21		TURNPIECES			CODE	PRICE
Pinned knob	A7	36			Hold open latch	E2	38		TP 1	T1	+ 18		
Large rose 3-1/8" diameter	A8	12			Auxiliary latch	E3	36		TP 3	T3	+ 18		
Mushroom knob	A9	6			2-3/4" backset, 1-1/8" x 2-1/4" face	E4	11		TP 4	T4	+ 18		
No logo	A10	NC			2-3/8" backset, 1" x 2-1/4" face	E6	NC		TP 5	T5	+ 18		
Engraved	A11	73			TRIM CHANGES		CODE	PRICE	TP 6	T6	+ 18		
Concealed cylinder	A12	28			Lead lined	F1	335		TP 7	T7	+ 18		
Dummy trim sub-assembly	A13	—			Large inside plate	F2	36		TP 9	T9	+ 18		
Coinkey w/ escutcheon plate	A14	72			Less inside trim**	F4	NC		TP 16	T16	+ 18		
Coinkey w/ rose	A15	72			Less outside trim**	F5	NC		ELECTRONICS			CODE	PRICE
Occupancy Indicator	A17	93			For 1-1/2" bore	F6	21		Sensor array package: REX & key switch	W1	330		
Tactile knob/lever, coated int. & ext.	A18	126			Adjustable spring collars	F10	6		Hard wired	W5	27		
BE 1-1/2" thick door adapter plate	A19	80			Corbin 6 pin IC core	F12	33		Request to exit switch	W10	140		
Rigid Lever	A20	NC			Corbin 7 pin IC core	F13	35		Key sensor	W11	165		
"Tear Drop" occupancy indicator	A21	81			Yale 6 pin IC core	F14	24		Titan lever	W12	20		
Crescent Lever	A22	NC			Yale 7 pin IC core	F15	24		Request to Exit switch, key sensor				
Square trim	A23	30			Less outside knob/lever	F16			& bolt sensor	W13	494		
- Square collar	A23C	+11			Dummy cylinder	F17	45		<i>(W13 option for mortise locksets)</i>				
- Square turnpiece	A23T	+11			Less outside trim w/ custom escutcheon**		F18	NC	Bolt sensor	W14	165		
Small emergency hole	A24	NC			Schlage 6 pin IC core	F19	24		Latch sensor	W15	165		
SS55 Knob on EXT or INT (specify)	A25	43			Sargent IC core	F20	24		REX + Latch sensor	W16	330		
Plaza Lever	A26	NC			Medeco IC core large format	F21	24		MISC			CODE	PRICE
Recessed Pull (one side)	A28	73			IQ lead lined	F22	428		Please read special comments	#			
Exposed Rose Screws	A29	NC			Rigid Lever	F23	NC		regarding line item.				
Engraved and Filled	A30	83			ASSA IC Core	F24	22		* Not available in CP plate design.				
Inside Knob on Lever	A31	36			Blank Inside Plate/Lever	F25	NC		** Consult factory before ordering.				
No inside turnpiece	A32	NC			Blank Outside Plate/Lever	F26	NC						
LOCK BODY <i>Red, Green, BCC, Ind.</i>			CODE	PRICE									
Lever override guard - outside*	B1	45			Yale 6 pin IC core w/ captivated tail	F27	NC						
Lever override guard - both sides*	B2	64			Yale 7 pin IC core w/ captivated tail	F28	NC						
Hardened pins - deadbolt	B3	19			Screwless Inside Escutcheon	F29	31						
Lever springs	B4	20			CYLINDER		CODE	PRICE					
Pin and lever springs	B5	38			IC core housing - 7 Pin	G1	NC						
Hollow spacer	B6	19			Special optional keyway	G2	38						
8 mm hubs on square	B7	19			Less cylinder	G3	Deduct 16						
Turnpiece hub on square	B8	12			MARKS "A" keyway	G4	15						
With deadbolt	B9	19			MARKS "C" keyway	G5	17						
Boxed Lock Body	B10	NC			IC core housing w/9271 Collar - 6 Pin	G6	NC						
Lever spring outside only	B11	NC			IC core housing, Schlage large format								
Lever spring inside only	B12	NC			(FOR MORTISE ONLY)	G7	82						



BARRIER PLATE DESIGN BA

	ANSI-A156.13 • Grade 1 3 Hour Fire Rating		Series 5 • 2-3/4" Backset Series 55 • 2-1/2" Backset	
	Standard Features		KNOBS	LEVERS
	<ul style="list-style-type: none"> • Thru-bolted screwless knob/lever plate assemblies • Independent spring loaded captivated spindles • Reversible mortise lock 2-1/2" or 2-3/4" backset • Lever support springs • Lock front: 1-1/4" x 8" • Dimensions: Ext: 10-1/8" H x 4" W, Int: 10-3/4" H x 4" W • Cylinder: MARKS "C" keyway, 6 pin w/ 2 keys 		10, 20	82, 83, 86, 92, 96
			FINISH GROUPS	
MARKS #	FUNCTION	ANSI #	32D	32D
KEYED SINGLE CYLINDER, NO DEADBOLT				
D	OFFICE VEST.		583	623
DW	VESTIBULE			
E	OFFICE	F04		
EW	STOREROOM	F07		
J	CLASSROOM	F05		
JM, JR	HOSPITAL	F06		
GL	INSTIT. PRIVACY	F26		
EL	ELECTRICALLY LOCKED		960	1001
EU	ELECTRICALLY UNLOCKED			
KEYED SINGLE CYLINDER, WITH DEADBOLT				
A	ENTRANCE	F08, F10	602	638
B	ENTRANCE	F21		
F	DORMITORY	F12		
FS	DORMITORY			
FW	DORMITORY	F13		
FD	APARTMENT	F20	627	667
H	HOTEL	F15		
LH	SPECIAL PRIVACY			
KEYED DOUBLE CYLINDER, NO DEADBOLT				
G	APARTMENT	F09	637	667
GC	INTRUDER LATCHBOLT	F32		
GG	CLASSROOM SECURITY			
GR	CLASSROOM SECURITY w/HOLDBACK			
WW	INSTITUTIONAL	F30		
KEYED DOUBLE CYLINDER, WITH DEADBOLT				
AC	ENTRANCE	F35	639	678
C	STOREROOM	F14		
FC	INTRUDER DEADBOLT	F34		
FA	DORMITORY	F11		
FX	DORMITORY	F33		
KEYLESS				
N	PASSAGE	F01	467	507
L	BATHROOM	F02	602	638
LF	PRIVACY	F19		
LJ	PRIVACY	F22	529	568
EX	EXIT	F31		
DUMMY TRIM				
DI	DUMMY TRIM INSIDE		237	275
DO	DUMMY TRIM OUTSIDE			
DT	FULLY DUMMY		474	512
KNOB & LEVER ARE PACKED 6 PER CASE				
NOTE: Split designs and/or finishes are priced at the highest design and/or finish • Special finishes, consult factory				

KNOB	Round Knob 10
	
	Ball Knob 20
	

LEVER	Plaza Lever 82 Specify handing
	
	Dayton Lever 83 Specify handing
	
	Crescent Lever 86
	
	American Lever 92
	
Titan Lever 96	
	

CLASSIC PLATE DESIGN CL

	ANSI-A156.13 • Grade 1 3 Hour Fire Rating		Series 5 • 2-3/4" Backset Series 55 • 2-1/2" Backset			
	Standard Features		KNOBS		LEVERS	
	<ul style="list-style-type: none"> • Thru-bolted screwless knob/lever plate assemblies • Independent spring loaded captivated spindles • Reversible mortise lock 2-1/2" or 2-3/4" backset • Lever support springs • Lock front: 1-1/4" x 8" • Dimensions: Ext: 8" H x 2-1/2" W, Int: 8" H x 2-1/2" W • Cylinder: MARKS "C" keyway, 6 pin w/ 2 keys • Height: 7/32" 		10, 20		031, 44, 55, 57, 72, 77, 78, 82, 83, 86, 92, 96	031, 82, 83, 86, 92, 96
FINISH GROUPS						
MARKS #	FUNCTION	ANSI #	3, 26D, 32D	10, 10B	3E, 10, 26D, 32D	10B, 32
KEYED SINGLE CYLINDER, NO DEADBOLT						
D	OFFICE VEST.		631	669	779	817
DW	VESTIBULE					
E	OFFICE	F04				
EW	STOREROOM	F07				
J	CLASSROOM	F05				
JM, JR	HOSPITAL	F06	957	995	1104	1142
GL	INSTIT. PRIVACY	F26				
EL	ELECTRICALLY LOCKED					
EU	ELECTRICALLY UNLOCKED					
KEYED SINGLE CYLINDER, WITH DEADBOLT						
A	ENTRANCE	F08, F10	645	684	793	831
B	ENTRANCE	F21				
F	DORMITORY	F12				
FS	DORMITORY					
FW	DORMITORY	F13	709	747	856	894
FD	APARTMENT	F20				
H	HOTEL	F15				
LH	SPECIAL PRIVACY					
KEYED DOUBLE CYLINDER, NO DEADBOLT						
G	APARTMENT	F09	680	718	827	866
GC	INTRUDER LATCHBOLT	F32				
GG	CLASSROOM SECURITY					
GR	CLASSROOM SECURITY w/HOLDBACK					
WW	INSTITUTIONAL	F30				
KEYED DOUBLE CYLINDER, WITH DEADBOLT						
AC	ENTRANCE	F35	680	718	827	866
C	STOREROOM	F14				
FC	INTRUDER DEADBOLT	F34				
FA	DORMITORY	F11				
FX	DORMITORY	F33				
KEYLESS						
N	PASSAGE	F01	530	569	678	716
L	BATHROOM	F02	647	685	794	832
LF	PRIVACY	F19				
LJ	PRIVACY	F22	584	622	731	769
EX	EXIT	F31	584	622	731	769
DUMMY TRIM						
DI	DUMMY TRIM INSIDE		267	285	340	359
DO	DUMMY TRIM OUTSIDE					
DT	FULLY DUMMY		531	570	679	711

KNOBS & LEVERS ARE PACKED 6 PER CASE



NOTE: Split designs and/or finishes are priced at the highest design and/or finish • Special finishes, consult factory

CLASSIC PLATE DESIGN CL

	ANSI-A156.13 • Grade 2		Series 7 • 2-3/4" Backset Series 9 • 2-1/2" Backset			
	Standard Features		KNOBS		LEVERS	
	<ul style="list-style-type: none"> • Thru-bolted screwless knob/lever plate assemblies • Independent spring loaded captivated spindles • Reversible mortise lock 2-1/2" or 2-3/4" backset • Lever support springs • Lock front Series 7: 1-1/4" x 8", Series 9: 1-1/16" x 7-5/8" • Dimensions: Ext: 8" H x 2-1/2" W, Int: 8" H x 2-1/2" W • Cylinder: MARKS "C" keyway, 6 pin w/ 2 keys 		10, 20		031, 44, 55, 57, 72, 77, 78, 82, 83, 86, 92, 96	031, 82, 83, 86, 92, 96
FINISH GROUPS						
MARKS #	FUNCTION	ANSI #	3, 26D, 32D	10, 10B	3E, 10, 26D, 32D	10B, 32
KEYED SINGLE CYLINDER, NO DEADBOLT						
D	OFFICE VEST.		598	637	746	785
DW	VESTIBULE					
KEYED SINGLE CYLINDER, WITH DEADBOLT						
A	ENTRANCE	F08, F10	613	648	760	798
B	ENTRANCE	F21				
F	DORMITORY	F12				
FS	DORMITORY					
FW	DORMITORY	F13				
KEYED DOUBLE CYLINDER, WITH DEADBOLT						
AC	ENTRANCE	F35	648	686	795	833
C	STOREROOM	F14				
FX	DORMITORY	F33				
KEYLESS						
N	PASSAGE	F01	497	536	645	684
L	BATHROOM	F02	614	652	761	799
LF	PRIVACY	F19				
DUMMY TRIM						
DI	DUMMY TRIM INSIDE		267	285	340	359
DO	DUMMY TRIM OUTSIDE					
DT	FULLY DUMMY		531	570	679	717
NOTE: Split designs and/or finishes are priced at the highest design and/or finish • Special finishes, consult factory						

KNOBS	Round Knob 10	Ball Knob 20				
						
LEVERS	Stanhope Lever 44	Copa Lever 031	Brompton Lever 55	Monaco Lever 57 Specify handing		
						
	Towne Lever 72	Maxwell Lever 77	Omni Lever 78	Plaza Lever 82 Specify handing		
						
	Dayton Lever 83 Specify handing	Crescent Lever 86	American Lever 92	Titan Lever 96		
						

CAPITOL PLATE DESIGN CP

		ANSI-A156.13 • Grade 1 3 Hour Fire Rating					Series 5 • 2-3/4" Backset Series 55 • 2-1/2" Backset	
	Standard Features		KNOBS		LEVERS			
	<ul style="list-style-type: none"> • Thru-bolted screwless knob/lever plate assemblies • Independent spring loaded captivated spindles • Reversible mortise lock 2-1/2" or 2-3/4" backset • Lever support springs • Lock front: 1-1/4" x 8" • Dimensions: Ext: 8-1/2" H x 2-3/4" W, Int: 8-1/2" H x 2-3/4" W • Cylinder: MARKS "C" keyway, 6 pin w/ 2 keys • Concealed 5 pin cylinder (option A12) • Thickness: 1/8" 		10, 20		031, 44, 55, 57, 72, 77, 78, 82, 83, 86, 92, 96		031, 82, 83, 86, 92, 96	
FINISH GROUPS								
MARKS #	FUNCTION	ANSI #	3, 32D	10, 10B	3, 32D	10, 10B		
KEYED SINGLE CYLINDER, NO DEADBOLT								
D	OFFICE VEST.		657	695	804	846		
DW	VESTIBULE							
E	OFFICE	F04						
EW	STOREROOM	F07						
J	CLASSROOM	F05						
JM, JR	HOSPITAL	F06						
GL	INSTIT. PRIVACY	F26						
EL	ELECTRICALLY LOCKED		983	1021	1130	1168		
EU	ELECTRICALLY UNLOCKED							
KEYED SINGLE CYLINDER, WITH DEADBOLT								
A	ENTRANCE	F08, F10	671	710	819	857		
B	ENTRANCE	F21						
F	DORMITORY	F12						
FS	DORMITORY							
FW	DORMITORY	F13						
FD	APARTMENT	F20	734	772	882	921		
H	HOTEL	F15						
LH	SPECIAL PRIVACY							
KEYED DOUBLE CYLINDER, NO DEADBOLT								
G	APARTMENT	F09	707	745	854	892		
GC	INTRUDER LATCHBOLT	F32						
GG	CLASSROOM SECURITY							
GR	CLASSROOM SECURITY w/HOLDBACK							
WW	INSTITUTIONAL	F30						
KEYED DOUBLE CYLINDER, WITH DEADBOLT								
AC	ENTRANCE	F35	707	745	854	892		
C	STOREROOM	F14						
FC	INTRUDER DEADBOLT	F34						
FA	DORMITORY	F11						
FX	DORMITORY	F33						
KEYLESS								
N	PASSAGE	F01	557	595	705	743		
L	BATHROOM	F02	673	711	820	858		
LF	PRIVACY	F19						
LJ	PRIVACY	F22	611	649	758	796		
EX	EXIT	F31	611	649	758	796		
DUMMY TRIM								
DI	DUMMY TRIM INSIDE		278	298	352	372		
DO	DUMMY TRIM OUTSIDE							
DT	FULLY DUMMY		557	596	706	744		

KNOBS & LEVERS ARE PACKED 6 PER CASE



NOTE: Split designs and/or finishes are priced at the highest design and/or finish • Special finishes, consult factory

CAPITOL PLATE DESIGN CP

	ANSI-A156.13 • Grade 2		Series 7 • 2-3/4" Backset Series 9 • 2-1/2" Backset				
	Standard Features		KNOBS		LEVERS		
	<ul style="list-style-type: none"> • Thru-bolted screwless knob/lever plate assemblies • Independent spring loaded captivated spindles • Reversible mortise lock 2-1/2" or 2-3/4" backset • Lever support springs • Lock front Series 7: 1-1/4" x 8", Series 9: 1-1/16" x 7-5/8" • Dimensions: Ext: 8-1/2" H x 2-3/4" W, Int: 8-1/2" H x 2-3/4" W • Cylinder: MARKS "C" keyway, 6 pin w/ 2 keys • Concealed 5 pin cylinder (option A12) 		10, 20		031, 44, 55, 57, 72, 77, 78, 82, 83, 86, 92, 96		
				FINISH GROUPS			
MARKS #	FUNCTION	ANSI #	3, 32D	10,10B	3, 32D	10, 10B	
KEYED SINGLE CYLINDER, NO DEADBOLT							
D	OFFICE VEST.		624	662	771	811	
DW	VESTIBULE						
KEYED SINGLE CYLINDER, WITH DEADBOLT							
A	ENTRANCE	F08, F10	639	677	786	824	
B	ENTRANCE	F21					
F	DORMITORY	F12					
FS	DORMITORY						
FW	DORMITORY	F13					
KEYED DOUBLE CYLINDER, WITH DEADBOLT							
AC	ENTRANCE	F35	674	712	821	859	
C	STOREROOM	F14					
FX	DORMITORY	F33					
KEYLESS							
N	PASSAGE	F01	524	562	672	710	
L	BATHROOM	F02	640	678	787	825	
LF	PRIVACY	F19					
DUMMY TRIM							
DI	DUMMY TRIM INSIDE		278	298	352	372	
DO	DUMMY TRIM OUTSIDE						
DT	FULLY DUMMY		557	596	706	744	
NOTE: Split designs and/or finishes are priced at the highest design and/or finish • Special finishes, consult factory							

KNOBS	Round Knob 10	Ball Knob 20				
						
LEVERS	Stanhope Lever 44	Copa Lever 031	Brompton Lever 55	Monaco Lever 57 Specify handing		
						
	Towne Lever 72	Maxwell Lever 77	Omni Lever 78	Plaza Lever 82 Specify handing		
						
	Dayton Lever 83 Specify handing	Crescent Lever 86	American Lever 92	Titan Lever 96		
						

CROWN PLATE DESIGN CR

		ANSI-A156.13 • Grade 1 3 Hour Fire Rating			Series 5 • 2-3/4" Backset Series 55 • 2-1/2" Backset						
	Standard Features		KNOBS			LEVERS					
	<ul style="list-style-type: none"> • Thru-bolted screwless knob/lever plate assemblies • Independent spring loaded captivated spindles • Reversible mortise lock 2-1/2" or 2-3/4" backset • Lever support springs • Lock front: 1-1/4" x 8" • Dimensions: Ext: 8-1/2" H x 2" W, Int: 8-1/2" H x 2" W • Cylinder: MARKS "C" keyway, 6 pin w/ 2 keys • Concealed 5 pin cylinder (option A12) • Height: 13/32" • Square Edges 		10, 20			30, 60			031, 44, 55, 57, 72, 77, 78, 82, 83, 86, 92, 96		031, 82, 83, 86, 92, 96
FINISH GROUPS											
MARKS #	FUNCTION	ANSI #	3, 26D, 32D	10, 10B, 32	3E, 15, 26D	10, 10B, 14	3E, 15, 26D	10, 10B, 14, 19E, 26	32, 32D		
KEYED SINGLE CYLINDER, NO DEADBOLT											
D	OFFICE VEST.		679	717	721	759	782	858	820		
DW	VESTIBULE										
E	OFFICE	F04									
EW	STOREROOM	F07									
J	CLASSROOM	F05									
JM, JR	HOSPITAL	F06									
GL	INSTIT. PRIVACY	F26									
EL	ELECTRICALLY LOCKED		1004	1043	1045	1069	1092	1168	1130		
EU	ELECTRICALLY UNLOCKED										
KEYED SINGLE CYLINDER, WITH DEADBOLT											
A	ENTRANCE	F08, F10	693	731	734	772	796	872	834		
B	ENTRANCE	F21									
F	DORMITORY	F12									
FS	DORMITORY										
FW	DORMITORY	F13									
FD	APARTMENT	F20	715	753	757	795	818	894	856		
H	HOTEL	F15									
LH	SPECIAL PRIVACY										
KEYED DOUBLE CYLINDER, NO DEADBOLT											
G	APARTMENT	F09	724	762	765	803	826	903	865		
GC	INTRUDER LATCHBOLT	F32									
GG	CLASSROOM SECURITY										
GR	CLASSROOM SECURITY w/HOLDBACK										
WW	INSTITUTIONAL	F30									
KEYED DOUBLE CYLINDER, WITH DEADBOLT											
AC	ENTRANCE	F35	724	762	765	803	826	903	865		
C	STOREROOM	F14									
FC	INTRUDER DEADBOLT	F34									
FA	DORMITORY	F11									
FX	DORMITORY	F33									
KEYLESS											
N	PASSAGE	F01	583	621	625	662	686	762	724		
L	BATHROOM	F02	693	731	734	772	796	872	834		
LF	PRIVACY	F19									
LJ	PRIVACY	F22	634	673	676	714	737	814	776		
EX	EXIT	F31									
DUMMY TRIM											
DI	DUMMY TRIM INSIDE		291	313	315	334	346	403	365		
DO	DUMMY TRIM OUTSIDE										
DT	FULLY DUMMY		588	626	630	668	691	767	729		

KNOBS & LEVERS ARE PACKED 6 PER CASE



NOTE: Split designs and/or finishes are priced at the highest design and/or finish • Special finishes, consult factory

CROWN PLATE DESIGN CR

	ANSI-A156.13 • Grade 2		Series 7 • 2-3/4" Backset Series 9 • 2-1/2" Backset						
	Standard Features		KNOBS				LEVERS		
	<ul style="list-style-type: none"> • Thru-bolted screwless knob/lever plate • Independent spring loaded captivated spindles • Reversible mortise lock 2-1/2" or 2-3/4" backset • Lever support springs • Lock front Series 7: 1-1/4" x 8", Series 9: 1-1/16" x 7-5/8" • Dimensions: Ext: 8-1/2" H x 2" W, Int: 8-1/2" H x 2" W • Cylinder: MARKS "C" keyway, 6 pin w/ 2 keys • Concealed 5 pin cylinder (option A12) 		10, 20		30, 60		031, 44, 55, 57, 72, 77, 78, 82, 83, 86, 92, 96		031, 82, 83, 86, 92,96
MARKS #	FUNCTION	ANSI #	FINISH GROUPS						
			3, 26D, 32D	10, 10B, 32	3E, 15, 26D	10, 10B, 14	3E, 15, 26D	10, 10B, 14, 19E, 26	32, 32D
KEYED SINGLE CYLINDER, NO DEADBOLT									
D	OFFICE VEST.		647	685	688	726	749	825	787
DW	VESTIBULE								
KEYED SINGLE CYLINDER, WITH DEADBOLT									
A	ENTRANCE	F08, F10	660	698	702	740	763	839	801
B	ENTRANCE	F21							
F	DORMITORY	F12							
FS	DORMITORY								
KEYED DOUBLE CYLINDER, WITH DEADBOLT									
AC	ENTRANCE	F35	691	729	732	770	794	870	832
C	STOREROOM	F14							
FX	DORMITORY	F33							
KEYLESS									
N	PASSAGE	F01	550	588	592	630	653	729	691
L	BATHROOM	F02	660	6998	702	741	763	839	801
LF	PRIVACY	F19							
DUMMY TRIM									
DI	DUMMY TRIM INSIDE		291	313	315	334	346	403	365
DO	DUMMY TRIM OUTSIDE								
DT	FULLY DUMMY								
NOTE: Split designs and/or finishes are priced at the highest design and/or finish • Special finishes, consult factory									

KNOBS	Round Knob 10	Ball Knob 20	Ball Knob 30	Eclipse Knob 60	
					
	LEVERS	Stanhope Lever 44	Copa Lever 031	Brompton Lever 55	Monaco Lever 57 Specify handing
					
Towne Lever 72		Maxwell Lever 77	Omni Lever 78	Plaza Lever 82 Specify handing	
					
	Dayton Lever 83 Specify handing	Crescent Lever 86	American Lever 92	Titan Lever 96	
					

DRAKE PLATE DESIGN DR

		ANSI-A156.13 • Grade 1 3 Hour Fire Rating								Series 5 • 2-3/4" Backset Series 55 • 2-1/2" Backset
	Standard Features		KNOBS				LEVERS			
	<ul style="list-style-type: none"> • Thru-bolted screwless knob/lever plate • Independent spring loaded captivated spindles • Reversible mortise lock 2-1/2" or 2-3/4" backset • Lever support springs • Lock front: 1-1/4" x 8" • Dimensions: Ext: 11" H x 2-1/2" W, Int: 11" H x 2-1/2" W • Cylinder: MARKS "C" keyway, 6 pin w/ 2 keys • Concealed 5 pin cylinder (option A12) • Height: 13/32" • Square Edges 		10, 20		30, 60		031, 44, 55, 57, 72, 77, 78, 82, 83, 86, 92, 96		031, 82, 83, 86, 92, 96	
FINISH GROUPS										
MARKS #	FUNCTION	ANSI #	3, 26D, 32D	10, 10B, 32	3E, 15, 26D	10, 10B, 14	3E, 15, 26D	10E, 10B, 14, 19E, 26	32, 32D	
KEYED SINGLE CYLINDER, NO DEADBOLT										
D	OFFICE VEST.									
DW	VESTIBULE									
E	OFFICE	F04								
EW	STOREROOM	F07	750	788	792	830	853	929	891	
J	CLASSROOM	F05								
JM, JR	HOSPITAL	F06								
GL	INSTIT. PRIVACY	F26								
EL	ELECTRICALLY LOCKED		1075	1113	1117	1139	1163	1239	1201	
EU	ELECTRICALLY UNLOCKED									
KEYED SINGLE CYLINDER, WITH DEADBOLT										
A	ENTRANCE	F08, F10								
B	ENTRANCE	F21								
F	DORMITORY	F12	764	802	805	844	867	943	905	
FS	DORMITORY									
FW	DORMITORY	F13								
FD	APARTMENT	F20								
H	HOTEL	F15	786	824	827	866	888	965	927	
LH	SPECIAL PRIVACY									
KEYED DOUBLE CYLINDER, NO DEADBOLT										
G	APARTMENT	F09								
GC	INTRUDER LATCHBOLT	F32								
GG	CLASSROOM SECURITY		795	833	836	874	897	974	935	
GR	CLASSROOM SECURITY w/HOLDBACK									
WW	INSTITUTIONAL	F30								
KEYED DOUBLE CYLINDER, WITH DEADBOLT										
AC	ENTRANCE	F35								
C	STOREROOM	F14								
FC	INTRUDER DEADBOLT	F34	795	833	836	874	897	974	935	
FA	DORMITORY	F11								
FX	DORMITORY	F33								
KEYLESS										
N	PASSAGE	F01	654	692	695	733	757	833	795	
L	BATHROOM	F02								
LF	PRIVACY	F19	764	802	805	844	867	943	905	
LJ	PRIVACY	F22								
EX	EXIT	F31	706	744	747	785	808	885	847	
DUMMY TRIM										
DI	DUMMY TRIM INSIDE		330	349	350	370	381	439	401	
DO	DUMMY TRIM OUTSIDE									
DT	FULLY DUMMY		659	697	700	740	762	838	800	

KNOBS & LEVERS ARE PACKED 6 PER CASE



NOTE: Split designs and/or finishes are priced at the highest design and/or finish • Special finishes, consult factory

DRAKE PLATE DESIGN DR

	ANSI-A156.13 • Grade 2		Series 7 • 2-3/4" Backset Series 9 • 2-1/2" Backset						
	Standard Features		KNOBBS				LEVERS		
	<ul style="list-style-type: none"> • Thru-bolted screwless knob/lever plate • Independent spring loaded captivated spindles • Reversible mortise lock 2-1/2" or 2-3/4" backset • Lever support springs • Lock front Series 7: 1-1/4" x 8", Series 9: 1-1/16" x 7-5/8" • Dimensions: Ext: 11" H x 2-1/2" W, Int: 11" H x 2-1/2" W • Cylinder: MARKS "C" keyway, 6 pin w/ 2 keys • Concealed 5 pin cylinder (option A12) 		10, 20		30, 60		031, 44, 55, 57, 72, 77, 78, 82, 83, 86, 92, 96		031, 82, 83, 86, 92, 96
FINISH GROUPS									
MARKS #	FUNCTION	ANSI #	3, 26D, 32D	10, 10B, 32	3E, 15, 26D	10, 10B, 14	3E, 15, 26D	10E, 10B, 14, 19E, 26, 32	32D
KEYED SINGLE CYLINDER, NO DEADBOLT									
D	OFFICE VEST.		719	756	759	797	820	896	858
DW	VESTIBULE								
KEYED SINGLE CYLINDER, WITH DEADBOLT									
A	ENTRANCE	F08, F10	731	769	772	812	834	911	872
B	ENTRANCE	F21							
F	DORMITORY	F12							
FS	DORMITORY								
KEYED DOUBLE CYLINDER, WITH DEADBOLT									
AC	ENTRANCE	F35	762	800	803	842	865	941	903
C	STOREROOM	F14							
FX	DORMITORY	F33							
KEYLESS									
N	PASSAGE	F01	621	659	662	701	724	800	762
L	BATHROOM	F02	731	769	772	812	834	911	872
LF	PRIVACY	F19							
DUMMY TRIM									
DI	DUMMY TRIM INSIDE		330	349	350	370	381	439	401
DO	DUMMY TRIM OUTSIDE								
DT	FULLY DUMMY								
NOTE: Split designs and/or finishes are priced at the highest design and/or finish • Special finishes, consult factory									

KNOBBS	Round Knob 10	Ball Knob 20	Ball Knob 30	Eclipse Knob 60
				
	Stanhope Lever 44	Copa Lever 031	Brompton Lever 55	Monaco Lever 57 Specify handing
				
LEVERS	Towne Lever 72	Maxwell Lever 77	Omni Lever 78	Plaza Lever 82 Specify handing
				
	Dayton Lever 83 Specify handing	Crescent Lever 86	American Lever 92	Titan Lever 96
				

DAVOS PLATE DESIGN DV











BHMA CERTIFIED		ANSI-A156.13 • Grade 1 3 Hour Fire Rating			Series 5 • 2-3/4" Backset Series 55 • 2-1/2" Backset				
	Standard Features		KNOBS			LEVERS			
	<ul style="list-style-type: none"> • Thru-bolted screwless knob/lever plate • Independent spring loaded captivated spindles • Reversible mortise lock 2-1/2" or 2-3/4" backset • Lever support springs • Lock front: 1-1/4" x 8" • Dimensions: Ext: 11" H x 2-1/2" W, Int: 11" H x 2-1/2" W • Cylinder: MARKS "C" keyway, 6 pin w/ 2 keys • Concealed 5 pin cylinder (option A12) • Height: 13/32" • Bevel Edges 		10, 20		30, 60		031, 44, 55, 57, 72, 77, 78, 82, 83, 86, 92, 96		
MARKS #	FUNCTION	ANSI #	FINISH GROUPS						
			3, 26D	10, 10B, 32	3E, 15, 26D	10, 10B, 14	3E, 15, 26D	10E, 10B, 14, 19E, 26	
KEYED SINGLE CYLINDER, NO DEADBOLT									
D	OFFICE VEST.								
DW	VESTIBULE								
E	OFFICE	F04							
EW	STOREROOM	F07	822	860	863	902	925	1001	
J	CLASSROOM	F05							
JM, JR	HOSPITAL	F06							
GL	INSTIT. PRIVACY	F26							
EL	ELECTRICALLY LOCKED		1147	1186	1189	1212	1233	1311	
EU	ELECTRICALLY UNLOCKED								
KEYED SINGLE CYLINDER, WITH DEADBOLT									
A	ENTRANCE	F08, F10							
B	ENTRANCE	F21							
F	DORMITORY	F12	836	874	878	916	938	1016	
FS	DORMITORY								
FW	DORMITORY	F13							
FD	APARTMENT	F20							
H	HOTEL	F15	858	896	899	938	961	1037	
LH	SPECIAL PRIVACY								
KEYED DOUBLE CYLINDER, NO DEADBOLT									
G	APARTMENT	F09							
GC	INTRUDER LATCHBOLT	F32							
GG	CLASSROOM SECURITY		867	905	908	947	969	1045	
GR	CLASSROOM SECURITY w/HOLDBACK								
WW	INSTITUTIONAL	F30							
KEYED DOUBLE CYLINDER, WITH DEADBOLT									
AC	ENTRANCE	F35							
1	STOREROOM	F14							
FC	INTRUDER DEADBOLT	F34	867	905	908	947	969	1046	
FA	DORMITORY	F11							
FX	DORMITORY	F33							
KEYLESS									
N	PASSAGE	F01	726	762	767	782	829	905	
L	90	F02	836	874	878	916	939	1016	
LF	PRIVACY	F19							
LJ	PRIVACY	F22	778	816	819	857	946	957	
EX	EXIT	F31							
DUMMY TRIM									
DI	DUMMY TRIM INSIDE		366	385	386	406	417	462	
DO	DUMMY TRIM OUTSIDE								
DT	FULLY DUMMY		731	769	772	812	834	911	

KNOBS & LEVERS ARE PACKED 6 PER CASE



NOTE: Split designs and/or finishes are priced at the highest design and/or finish • Special finishes, consult factory

DAVOS PLATE DESIGN DV

	ANSI-A156.13 • Grade 2		Series 7 • 2-3/4" Backset Series 9 • 2-1/2" Backset					
	Standard Features		KNOBS			LEVERS		
	<ul style="list-style-type: none"> • Thru-bolted screwless knob/lever plate • Independent spring loaded captivated spindles • Reversible mortise lock 2-1/2" or 2-3/4" backset • Lever support springs • Lock front Series 7: 1-1/4" x 8", Series 9: 1-1/16" x 7-5/8" • Dimensions: Ext: 11" H x 2-1/2" W, Int: 11" H x 2-1/2" W • Cylinder: MARKS "C" keyway, 6 pin w/ 2 keys • Concealed 5 pin cylinder (option A12) 		10, 20		30, 60		031, 44, 55, 57, 72, 77, 78, 82, 83, 86, 92, 96	
FINISH GROUPS								
MARKS #	FUNCTION	ANSI #	3, 26D	10, 10B,32	3E, 15, 26D	10, 10B,14	3E, 15, 26D	10E, 10B, 14, 19E, 26
KEYED SINGLE CYLINDER, NO DEADBOLT								
D	OFFICE VEST.		789	827	831	869	892	968
DW	VESTIBULE							
KEYED SINGLE CYLINDER, WITH DEADBOLT								
A	ENTRANCE	F08, F10	803	842	845	884	906	983
B	ENTRANCE	F21						
F	DORMITORY	F12						
FS	DORMITORY							
KEYED DOUBLE CYLINDER, WITH DEADBOLT								
AC	ENTRANCE	F35	834	872	875	914	936	1014
C	STOREROOM	F14						
FX	DORMITORY	F33						
KEYLESS								
N	PASSAGE	F01	693	731	734	772	745	872
L	BATHROOM	F02	803	842	845	881	906	983
LF	PRIVACY	F19						
DUMMY TRIM								
DI	DUMMY TRIM INSIDE		366	385	386	406	417	462
DO	DUMMY TRIM OUTSIDE							
DT	FULLY DUMMY		731	769	772	812	834	911
NOTE: Split designs and/or finishes are priced at the highest design and/or finish • Special finishes, consult factory								

KNOBS	Round Knob 10	Ball Knob 20	Ball Knob 30	Eclipse Knob 60
				
	Stanhope Lever 44	Copa Lever 031	Brompton Lever 55	Monaco Lever 57 Specify handing
				
LEVERS	Towne Lever 72	Maxwell Lever 77	Omni Lever 78	Plaza Lever 82 Specify handing
				
	Dayton Lever 83 Specify handing	Crescent Lever 86	American Lever 92	Titan Lever 96
				

MADISON PLATE DESIGN MA

	ANSI-A156.13 • Grade 1 3 Hour Fire Rating			Series 5 • 2-3/4" Backset Series 55 • 2-1/2" Backset	
	Standard Features			KNOBS	LEVERS
	<ul style="list-style-type: none"> • Thru-bolted screwless knob/lever plate assemblies • Independent spring loaded captivated spindles • Reversible mortise lock 2-1/2" or 2-3/4" backset • Lever support springs • Lock front: 1-1/4" x 8" • Dimensions: Ext: 10-1/2" H x 2-5/32" W, Int: 10-1/2" H x 2-5/32" W • Cylinder: MARKS "C" keyway, 6 pin w/ 2 keys • Height: 13/32" 			30, 60	031, 44, 55, 57, 72, 77, 78, 82, 83, 86, 92, 96
FINISH GROUPS					
MARKS #	FUNCTION	ANSI #	3E & 15	3E & 15	
KEYED SINGLE CYLINDER, NO DEADBOLT					
D	OFFICE VEST.				
DW	VESTIBULE				
E	OFFICE	F04			
EW	STOREROOM	F07	869	906	
J	CLASSROOM	F05			
JM, JR	HOSPITAL	F06			
GL	INSTIT. PRIVACY	F26			
EL	ELECTRICALLY LOCKED		1212	1248	
EU	ELECTRICALLY UNLOCKED				
KEYED SINGLE CYLINDER, WITH DEADBOLT					
A	ENTRANCE	F08, F10			
B	ENTRANCE	F21			
F	DORMITORY	F12	886	922	
FS	DORMITORY				
FW	DORMITORY	F13			
FD	APARTMENT	F20	909	943	
H	HOTEL	F15			
LH	SPECIAL PRIVACY				
KEYED DOUBLE CYLINDER, NO DEADBOLT					
G	APARTMENT	F09			
GC	INTRUDER LATCHBOLT	F32			
GG	CLASSROOM SECURITY		918	956	
GR	CLASSROOM SECURITY w/HOLDBACK				
WW	INSTITUTIONAL	F30			
KEYED DOUBLE CYLINDER, WITH DEADBOLT					
AC	ENTRANCE	F35			
C	STOREROOM	F14			
FC	INTRUDER DEADBOLT	F34	918	956	
FA	DORMITORY	F11			
FX	DORMITORY	F33			
KEYLESS					
N	PASSAGE	F01	764	799	
L	BATHROOM	F02	886	922	
LF	PRIVACY	F19			
LJ	PRIVACY	F22	820	857	
EX	EXIT	F31			
DUMMY TRIM					
DI	DUMMY TRIM INSIDE		385	418	
DO	DUMMY TRIM OUTSIDE				
DT	FULLY DUMMY		769	805	

KNOBS & LEVERS ARE PACKED 6 PER CASE



NOTE: Split designs and/or finishes are priced at the highest design and/or finish • Special finishes, consult factory

MADISON PLATE DESIGN MA

	ANSI-A156.13 • Grade 2		Series 7 • 2-3/4" Backset Series 9 • 2-1/2" Backset	
	Standard Features		KNOBS	LEVERS
	<ul style="list-style-type: none"> • Thru-bolted screwless knob/lever plate assemblies • Independent spring loaded captivated spindles • Reversible mortise lock 2-1/2" or 2-3/4" backset • Lever support springs • Lock front Series 7: 1-1/4" x 8", Series 9: 1-1/16" x 7-5/8" • Dimensions: Ext: 10-1/2" H x 2-5/32" W, Int: 10-1/2" H x 2-5/32" W • Cylinder: MARKS "C" keyway, 6 pin w/ 2 keys • Height: 13/32" 		30, 60	031, 44, 55, 57, 72, 77, 78, 82, 83, 86, 92, 96
FINISH GROUPS				
MARKS #	FUNCTION	ANSI #	3E & 15	3E & 15
KEYED SINGLE CYLINDER, NO DEADBOLT				
D	OFFICE VEST.		834	870
DW	VESTIBULE			
KEYED SINGLE CYLINDER, WITH DEADBOLT				
A	ENTRANCE	F08, F10	850	886
B	ENTRANCE	F21		
F	DORMITORY	F12		
FS	DORMITORY			
FW	DORMITORY	F13		
KEYED DOUBLE CYLINDER, WITH DEADBOLT				
AC	ENTRANCE	F35	884	920
C	STOREROOM	F14		
FX	DORMITORY	F33		
KEYLESS				
N	PASSAGE	F01	728	764
L	BATHROOM	F02	850	886
LF	PRIVACY	F19		
DUMMY TRIM				
DI	DUMMY TRIM INSIDE		385	418
DO	DUMMY TRIM OUTSIDE			
DT	FULLY DUMMY		769	805
NOTE: Split designs and/or finishes are priced at the highest design and/or finish • Special finishes, consult factory				

KNOBS	Ball Knob 30	Eclipse Knob 60		
				
LEVERS	Stanhope Lever 44	Copa Lever 031	Brompton Lever 55	Monaco Lever 57 Specify handing
				
	Towne Lever 72	Maxwell Lever 77	Omni Lever 78	Plaza Lever 82 Specify handing
				
	Dayton Lever 83 Specify handing	Crescent Lever 86	American Lever 92	Titan Lever 96
				

NEW YORKER PLATE DESIGN NY



		ANSI-A156.13 • Grade 1 3 Hour Fire Rating				Series 5 • 2-3/4" Backset Series 55 • 2-1/2" Backset					
		Standard Features		KNOBS		LEVERS					
<ul style="list-style-type: none"> • Thru-bolted screwless knob/lever plate assemblies • Independent spring loaded captivated spindles • Reversible mortise lock 2-1/2" or 2-3/4" backset • Lever support springs • Lock front: 1-1/4" x 8" • Dimensions: Ext: 10" H x 2-3/4" W, *Int: 7" H x 2-1/4" W • Cylinder: MARKS "C" keyway, 6 pin w/ 2 keys • Thickness: 1/4" 				10, 20		30, 60		031, 44, 55, 57, 72, 77, 78, 82, 83, 86, 92, 96			
MARKS #		FUNCTION		ANSI #		FINISH GROUPS					
						3	26D	3	26D	3	26D
KEYED SINGLE CYLINDER, NO DEADBOLT											
D	OFFICE VEST.										
DW	VESTIBULE										
E	OFFICE	F04									
EW	STOREROOM	F07		432	471	488	526	531	571		
J	CLASSROOM	F05									
JM, JR	HOSPITAL	F06									
GL	INSTIT. PRIVACY	F26									
EL	ELECTRICALLY LOCKED			790	830	848	886	891	930		
EU	ELECTRICALLY UNLOCKED										
KEYED SINGLE CYLINDER, WITH DEADBOLT											
A	ENTRANCE	F08, F10									
B	ENTRANCE	F21									
F	DORMITORY	F12		449	485	506	544	549	588		
FS	DORMITORY										
FW	DORMITORY	F13									
FD	APARTMENT	F20									
H	HOTEL	F15		474	513	530	569	575	614		
LH	SPECIAL PRIVACY										
KEYED DOUBLE CYLINDER, NO DEADBOLT											
G	APARTMENT	F09									
GC	INTRUDER LATCHBOLT	F32									
GG	CLASSROOM SECURITY			483	531	540	578	583	622		
GR	CLASSROOM SECURITY w/HOLDBACK										
WW	INSTITUTIONAL	F30									
KEYED DOUBLE CYLINDER, WITH DEADBOLT											
AC	ENTRANCE	F35									
C	STOREROOM	F14									
FC	INTRUDER DEADBOLT	F34		483	531	540	578	583	622		
FA	DORMITORY	F11									
FX	DORMITORY	F33									
KEYLESS											
N	PASSAGE	F01		320	359	377	415	420	459		
L	BATHROOM	F02		449	485	506	544	549	588		
LF	PRIVACY	F19									
LJ	PRIVACY	F22		380	419	437	475	480	520		
EX	EXIT	F31									
DUMMY TRIM											
DI	DUMMY TRIM INSIDE			164	183	193	211	216	255		
DO	DUMMY TRIM OUTSIDE										
DT	FULLY DUMMY			327	366	383	421	426	467		
KNOB & LEVERS ARE PACKED 6 PER CASE											
NOTE: Split designs and/or finishes are priced at the highest design and/or finish • Special finishes, consult factory											
* Large interior plate available (10" H x 2-3/4" W)											

NEW YORKER PLATE DESIGN NY

	ANSI-A156.13 • Grade 2		Series 7 • 2-3/4" Backset Series 9 • 2-1/2" Backset					
	Standard Features		KNOB			LEVERS		
	<ul style="list-style-type: none"> • Thru-bolted screwless knob/lever plate assemblies • Independent spring loaded captivated spindles • Reversible mortise lock 2-1/2" or 2-3/4" backset • Lever support springs • Lock front Series 7: 1-1/4" x 8"; Series 9: 1-1/16" x 7-5/8" • Dimensions: Ext: 10" H x 2-3/4" W, *Int: 7" H x 2-1/4" W • Cylinder: MARKS "C" keyway, 6 pin w/ 2 keys 		10, 20		30, 60		031, 44, 55, 57, 72, 77, 78, 82, 83, 86, 92, 96	
MARKS #	FUNCTION	ANSI #	FINISH GROUPS					
			3	26D	3	26D	3	26D
KEYED SINGLE CYLINDER, NO DEADBOLT								
D	OFFICE VEST.		399	438	455	493	510	549
DW	VESTIBULE							
KEYED SINGLE CYLINDER, WITH DEADBOLT								
A	ENTRANCE	F08, F10	416	452	473	511	516	556
B	ENTRANCE	F21						
F	DORMITORY	F12						
FS	DORMITORY							
FW	DORMITORY	F13						
KEYED DOUBLE CYLINDER, WITH DEADBOLT								
AC	ENTRANCE	F35	450	489	507	545	550	589
C	STOREROOM	F14						
FX	DORMITORY	F33						
KEYLESS								
N	PASSAGE	F01	289	327	344	382	387	426
L	BATHROOM	F02	416	452	493	511	561	600
LF	PRIVACY	F19						
DUMMY TRIM								
DI	DUMMY TRIM INSIDE		164	183	193	211	216	255
DO	DUMMY TRIM OUTSIDE							
DT	FULLY DUMMY		327	366	383	421	426	467
KNOB & LEVERS ARE PACKED 6 PER CASE								
NOTE: Split designs and/or finishes are priced at the highest design and/or finish • Special finishes, consult factory								
* Large interior plate available (10" H x 2-3/4" W)								

KNOB	Round Knob 10	Ball Knob 20	Ball Knob 30	Eclipse Knob 60
				
	Stanhope Lever 44	Copa Lever 031	Brompton Lever 55	Monaco Lever 57 Specify handing
				
LEVER	Towne Lever 72	Maxwell Lever 77	Omni Lever 78	Plaza Lever 82 Specify handing
				
	Dayton Lever 83 Specify handing	Crescent Lever 86	American Lever 92	Titan Lever 96
				

TOWNE PLATE DESIGN TN



		ANSI-A156.13 • Grade 1 3 Hour Fire Rating		Series 5 • 2-3/4" Backset Series 55 • 2-1/2" Backset			
	Standard Features		KNOBS		LEVERS		
	<ul style="list-style-type: none"> • Thru-bolted screwless knob/lever plate assemblies • Independent spring loaded captivated spindles • Reversible mortise lock 2-1/2" or 2-3/4" backset • Lever support springs • Lock front: 1-1/4" x 8" • Dimensions: Ext: 9-1/4" H x 2-1/4" W, Int: 9-1/4" H x 2-1/4" W • Cylinder: MARKS "C" keyway, 6 pin w/ 2 keys • Thickness: 13/32" 		30, 60		031, 44, 55, 57, 72, 77, 78, 82, 83, 86, 92, 96		
MARKS #		FUNCTION	ANSI #	3E & 15	26	3E & 15	26
KEYED SINGLE CYLINDER, NO DEADBOLT							
D	OFFICE VEST.			869	907	916	956
DW	VESTIBULE						
E	OFFICE	F04					
EW	STOREROOM	F07					
J	CLASSROOM	F05					
JM, JR	HOSPITAL	F06					
GL	INSTIT. PRIVACY	F26					
EL	ELECTRICALLY LOCKED			1230	1268	1275	1314
1275	ELECTRICALLY UNLOCKED						
KEYED SINGLE CYLINDER, WITH DEADBOLT							
A	ENTRANCE	F08, F10		887	925	933	970
B	ENTRANCE	F21					
F	DORMITORY	F12					
FS	DORMITORY						
FW	DORMITORY	F13					
FD	APARTMENT	F20		912	947	960	996
H	HOTEL	F15					
LH	SPECIAL PRIVACY						
KEYED DOUBLE CYLINDER, NO DEADBOLT							
G	APARTMENT	F09		922	960	968	1006
GC	INTRUDER LATCHBOLT	F32					
GG	CLASSROOM SECURITY						
GR	CLASSROOM SECURITY w/HOLDBACK						
WW	INSTITUTIONAL	F30					
KEYED DOUBLE CYLINDER, WITH DEADBOLT							
AC	ENTRANCE	F35		922	960	968	1006
C	STOREROOM	F14					
FC	INTRUDER DEADBOLT	F34					
FA	DORMITORY	F11					
FX	DORMITORY	F33					
KEYLESS							
N	PASSAGE	F01		760	796	805	843
L	BATHROOM	F02		887	925	933	970
LF	PRIVACY	F19					
LJ	PRIVACY	F22		818	857	865	904
EX	EXIT	F31					
DUMMY TRIM							
DI	DUMMY TRIM INSIDE			382	418	406	444
DO	DUMMY TRIM OUTSIDE						
DT	FULLY DUMMY			765	802	813	851
KNOBS & LEVERS ARE PACKED 6 PER CASE							
NOTE: Split designs and/or finishes are priced at the highest design and/or finish • Special finishes, consult factory							

TOWNE PLATE DESIGN TN

	ANSI-A156.13 • Grade 2		Series 7 • 2-3/4" Backset Series 9 • 2-1/2" Backset			
	Standard Features		KNOBS		LEVERS	
	<ul style="list-style-type: none"> • Thru-bolted screwless knob/lever plate assemblies • Independent spring loaded captivated spindles • Reversible mortise lock 2-1/2" or 2-3/4" backset • Lever support springs • Lock front Series 7: 1-1/4" x 8"; Series 9: 1-1/16" x 7-5/8" • Dimensions: Ext: 9-1/4" H x 2-1/4" W, Int: 9-1/4" H x 2-1/4" W • Cylinder: MARKS "C" keyway, 6 pin w/ 2 keys 		30, 60		031, 44, 55, 57, 72, 77, 78, 82, 83, 86, 92, 96	
		FINISH GROUPS				
MARKS #	FUNCTION	ANSI #	3E & 15	26	3E & 15	26
KEYED SINGLE CYLINDER, NO DEADBOLT						
D	OFFICE VEST.		793	827	837	872
DW	VESTIBULE					
KEYED SINGLE CYLINDER, WITH DEADBOLT						
A	ENTRANCE	F08, F10	808	844	852	889
B	ENTRANCE	F21				
F	DORMITORY	F12				
FS	DORMITORY					
FW	DORMITORY	F13				
KEYED DOUBLE CYLINDER, WITH DEADBOLT						
AC	ENTRANCE	F35	842	877	887	922
C	STOREROOM	F14				
FX	DORMITORY	F33				
KEYLESS						
N	PASSAGE	F01	687	728	730	766
L	BATHROOM	F02	808	844	852	889
LF	PRIVACY	F19				
DUMMY TRIM						
DI	DUMMY TRIM INSIDE		382	418	406	444
DO	DUMMY TRIM OUTSIDE					
DT	FULLY DUMMY		765	802	813	851
KNOBES & LEVERS ARE PACKED 6 PER CASE						
NOTE: Split designs and/or finishes are priced at the highest design and/or finish • Special finishes, consult factory						

KNOBES	Ball Knob 30	Eclipse Knob 60		
				
LEVERS	Stanhope Lever 44	Copa Lever 031	Brompton Lever 55	Monaco Lever 57 Specify handing
				
	Towne Lever 72	Maxwell Lever 77	Omni Lever 78	Plaza Lever 82 Specify handing
				
	Dayton Lever 83 Specify handing	Crescent Lever 86	American Lever 92	Titan Lever 96
				

ROSE DESIGN RR, RW, RQ, RS, RX*, RK*, RL*

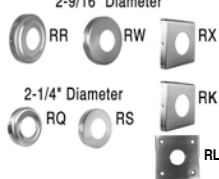

	ANSI-A156.13 • Grade 1 3 Hour Fire Rating		Series 5 • 2-3/4" Backset Series 55 • 2-1/2" Backset						
			Standard Features		KNOBS		LEVERS		
	<ul style="list-style-type: none"> • Thru-bolted screwless knob/lever rose assemblies • Independent spring loaded captivated spindles • Reversible mortise lock 2-1/2" or 2-3/4" backset • Lever support springs • Lock front: 1-1/4" x 8" • Cylinder: MARKS "C" keyway, 6 pin w/ 2 keys 		10, 20	30, 60	031, 44, 55, 57, 72, 77, 78, 82, 83, 86, 92, 96			82, 83, 86, 92, 96	
			FINISH GROUPS						
MARKS #	FUNCTION	ANSI #	3, 32D	3E, 15	26, 10B	3, 4, 15, 26D	14, 26, 32	10E, 10B, 19E	32D
KEYED SINGLE CYLINDER, NO DEADBOLT									
D	OFFICE VEST.								
DW	614								
E	OFFICE	F04							
EW	STOREROOM	F07	577	637	675	614	652	690	614
J	CLASSROOM	F05							
JM, JR	HOSPITAL	F06							
GL	INSTIT. PRIVACY	F26							
EL	ELECTRICALLY LOCKED		902	962	1000	939	977	1004	939
EU	ELECTRICALLY UNLOCKED								
KEYED SINGLE CYLINDER, WITH DEADBOLT									
A	ENTRANCE	F08, F10							
B	ENTRANCE	F21							
F	DORMITORY	F12	590	651	689	628	666	693	628
FS	DORMITORY								
FW	DORMITORY	F13							
FD	APARTMENT	F20							
H	HOTEL	F15	613	673	711	650	688	715	650
LH	SPECIAL PRIVACY								
KEYED DOUBLE CYLINDER, NO DEADBOLT									
G	APARTMENT	F09							
GC	INTRUDER LATCHBOLT	F32							
GG	CLASSROOM SECURITY		621	681	720	658	696	724	658
GR	CLASSROOM SECURITY w/HOLDBACK								
WW	INSTITUTIONAL	F30							
KEYED DOUBLE CYLINDER, WITH DEADBOLT									
AC	ENTRANCE	F35							
C	STOREROOM	F14							
FC	INTRUDER DEADBOLT	F34	621	681	720	658	696	724	658
FA	DORMITORY	F11							
FX	DORMITORY	F33							
KEYLESS									
N	PASSAGE	F01	448	571	609	563	602	609	563
L	BATHROOM	F02	590	651	689	628	666	693	628
LF	PRIVACY	F19							
LJ	PRIVACY	F22	531	592	630	569	607	634	569
EX	EXIT	F31							
DUMMY TRIM									
DI	DUMMY TRIM INSIDE		121	149	169	139	158	717	139
DO	DUMMY TRIM OUTSIDE								
DT	FULLY DUMMY		239	299	338	276	314	342	276
KNOB & LEVERS ARE PACKED 6 PER CASE NOTE: Split designs and/or finishes are priced at the highest design and/or finish • Special finishes, consult factory F17 Dummy Cylinder: Add \$44.00 *Square Rose RX: Add \$30 / *Square Rose RZ: Add \$70 / *Square Rose RK: Add \$100									



ROSE DESIGN RR, RW, RQ, RS, RX*, RK*, RL*

Diameter RR RW RX Diameter RQ RS RK		ANSI-A156.13 • Grade 2	Series 7 • 2-3/4" Backset Series 9 • 2-1/2" Backset							
Standard Features		KNOBS			LEVERS					
<ul style="list-style-type: none"> • Thru-bolted screwless knob/lever rose assemblies • Independent spring loaded captivated spindles • Reversible mortise lock 2-1/2" or 2-3/4" backset • Lever support springs • Lock front Series 7: 1-1/4" x 8"; Series 9: 1-1/16" x 7-5/8" • Cylinder: MARKS "C" keyway, 6 pin w/ 2 keys 		10, 20	30, 60		031, 44, 55, 57, 72, 77, 78, 82, 83, 86, 92, 96			82, 83, 86, 92, 96		
MARKS #		FUNCTION	ANSI #	3, 32D	3E, 15	26, 10B	3, 4, 15, 26D	14, 26, 32	10E, 10B, 19E	32D
KEYED SINGLE CYLINDER, NO DEADBOLT										
D	OFFICE VEST.			544	604	633	581	619	647	581
DW	VESTIBULE									
KEYED SINGLE CYLINDER, WITH DEADBOLT										
A	ENTRANCE	F08, F10								
B	ENTRANCE	F21								
F	DORMITORY	F12	558	618	656	595	633	660	595	
FS	DORMITORY									
FW	DORMITORY	F13								
KEYED DOUBLE CYLINDER, WITH DEADBOLT										
AC	ENTRANCE	F35								
C	STOREROOM	F14	588	649	687	625	663	691	625	
FX	DORMITORY	F33								
KEYLESS										
N	PASSAGE	F01	448	508	546	485	523	550	485	
L	BATHROOM	F02	558	618	656	595	695	660	595	
LF	PRIVACY	F19								
DUMMY TRIM										
DI	DUMMY TRIM INSIDE		121	149	169	139	158	171	139	
DO	DUMMY TRIM OUTSIDE									
DT	FULLY DUMMY		239	299	338	276	314	342	276	
NOTE: Split designs and/or finishes are priced at the highest design and/or finish • Special finishes, consult factory *Square Rose RX: Add \$30 / *Square Rose RZ: Add \$70 / *Square Rose RK: Add \$100										

KNOBS	Round Knob 10	Ball Knob 20	Ball Knob 30	Eclipse Knob 60	ROSES	RR: 2-9/16" dia.
LEVERS	Stanhope Lever 44	Copa Lever 031	Brompton Lever 55	Monaco Lever 57 Specify handing		RQ: 2-1/4" dia.
						RS: 2-1/4" dia.
	Towne Lever 72	Maxwell Lever 77	Omni Lever 78	Plaza Lever 82 Specify handing		
	Dayton Lever 83 Specify handing	Crescent Lever 86	American Lever 92	Titan Lever 96		



CROWN HANDLESET DESIGN CR

		ANSI-A156.13 • Grade 1 3 Hour Fire Rating		Series 4 • 2-3/4" Backset	Series 6 • 2-3/4" Backset	
				Series 45 • 2-1/2" Backset	Series 8 • 2-1/2" Backset	
	Standard Features <ul style="list-style-type: none"> • Exterior handle plate assemblies with thru-posts • Interior thru-bolted screwless knob/lever plate assemblies • Independent spring loaded captivated spindles • Reversible mortise lock 2-1/2" or 2-3/4" backset • Lever support springs • Lock front Series 4, 45: 1-1/4" x 8" • Lock front Series 6: 1-1/4" x 8"; Series 8: 1-1/16" x 7-5/8" • Dimensions: CROWN Ext: 16" H x 2" W, Int: 8-1/2" H x 2" W • Dimensions: GRAND CROWN Ext: 16" H x 2" W, Int: 8-1/2" H x 2" W • Cylinder: MARKS "C" keyway, 6 pin w/ 2 keys • Thickness: 13/32" 		KNOB 30, 60	LEVERS 031, 44, 55, 57, 72, 77, 78, 82, 83, 86, 92, 96	KNOB 30, 60	LEVERS 031, 44, 55, 57, 72, 77, 78, 82, 83, 86, 92, 96
			FINISH GROUPS 3E & 15		FINISH GROUPS 3E & 15	
GRADE 1 HANDLESETS	MARKS #	FUNCTION	ANSI #	3E & 15		
	KEYED SINGLE CYLINDER, NO DEADBOLT					
	D	OFFICE VEST.			1221	1160
	DW	VESTIBULE				
	EW	STOREROOM	F07		1185	
	KEYED SINGLE CYLINDER, WITH DEADBOLT					
	A	ENTRANCE	F08, F10			
	B	ENTRANCE	F21		1235	1175
	F	DORMITORY	F12			
	KEYED DOUBLE CYLINDER, WITH DEADBOLT					
	AC	ENTRANCE	F35		1269	1208
	C	STOREROOM	F25			
G	APARTMENT	F24		1269		
SO	STOREROOM: DOUBLE HANDLESET ONLY	F25		1572	1511	
DUMMY TRIM						
DT	FULLY DUMMY			995	995	
HANDLESETS ARE PACKED 6 PER CASE NOTE: Split designs and/or finishes are priced at the highest design and/or finish • Special finishes, consult factory SO Function Double Handleset ONLY * SERIES 45 NOT AVAILABLE IN "SO" FUNCTION						

KNOB	Ball Knob 30	Eclipse Knob 60
		

LEVERS	Stanhope Lever 44	Copa Lever 031	Brompton Lever 55	Monaco Lever 57 Specify handing
				
	Towne Lever 72	Maxwell Lever 77	Omni Lever 78	Plaza Lever 82 Specify handing
				
	Dayton Lever 83 Specify handing	Crescent Lever 86	American Lever 92	Titan Lever 96
				

TOWNE HANDLESET DESIGN TN



 		ANSI-A156.13 • Grade 1 3 Hour Fire Rating		Series 4 • 2-3/4" Backset Series 45 • 2-1/2" Backset	Series 6 • 2-3/4" Backset Series 8 • 2-1/2" Backset	
		Standard Features		KNOBS	LEVERS	KNOBS
<ul style="list-style-type: none"> • Exterior handle plate assemblies with thru-posts • Interior thru-bolted screwless knob/lever plate assemblies • Independent spring loaded captivated spindles • Reversible mortise lock 2-1/2" or 2-3/4" backset • Lever support springs • Lock front Series 4, 45: 1-1/4" x 8" • Lock front Series 6: 1-1/4" x 8"; Series 8: 1-1/16" x 7-5/8" • Dimensions: TOWNE Ext: 16-3/8" H x 2-1/4" W, Int: 9-1/4" H x 2-1/4" W • Dimensions: • Cylinder: MARKS "C" keyway, 6 pin w/ 2 keys • Thickness: 13/32" 		30, 60	031, 44, 55, 57, 72, 77, 78, 82, 83, 86, 92, 96	30, 60	031, 44, 55, 57, 72, 77, 78, 82, 83, 86, 92, 96	
		FINISH GROUPS		FINISH GROUPS		
GRADE 1 HANDLESETS	MARKS #	FUNCTION	ANSI #	3E & 15	3E & 15	
	KEYED SINGLE CYLINDER, NO DEADBOLT					
	D	OFFICE VEST.			1221	1160
	DW	VESTIBULE				
	EW	STOREROOM	F07		1221	
	KEYED SINGLE CYLINDER, WITH DEADBOLT					
	A	ENTRANCE	F08, F10			
	B	ENTRANCE	F21		1235	1175
	F	DORMITORY	F12			
	KEYED DOUBLE CYLINDER, WITH DEADBOLT					
	AC	ENTRANCE	F35		1269	1208
	C	STOREROOM	F25			
G	APARTMENT	F24		1269		
SO	STOREROOM: DOUBLE HANDLESET ONLY	F25		1572	1511	
DUMMY TRIM						
DT	FULLY DUMMY			995	995	

GRADE 2 HANDLESETS

HANDLESETS ARE PACKED 6 PER CASE

NOTE: Split designs and/or finishes are priced at the highest design and/or finish • Special finishes, consult factory

SO Function Double Handleset ONLY * SERIES 45 NOT AVAILABLE IN "SO" FUNCTION

KNOBS	Ball Knob 30	Eclipse Knob 60
		

LEVERS	Stanhope Lever 44	Copa Lever 031	Brompton Lever 55	Monaco Lever 57 Specify handing
				
	Towne Lever 72	Maxwell Lever 77	Omni Lever 78	Plaza Lever 82 Specify handing
				
	Dayton Lever 83 Specify handing	Crescent Lever 86	American Lever 92	Titan Lever 96
				

ORNAMENTAL IRON

Ornamental Iron

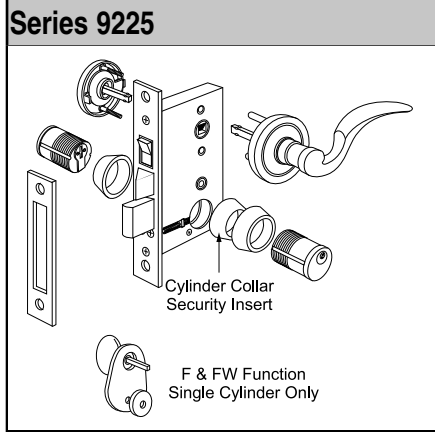
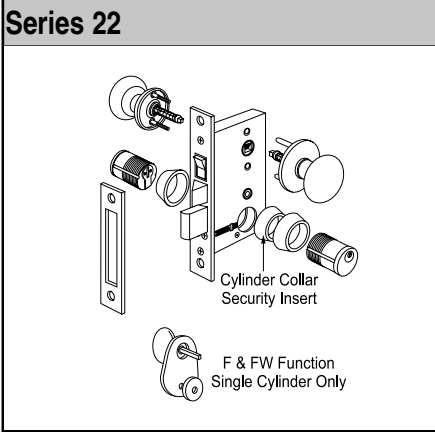
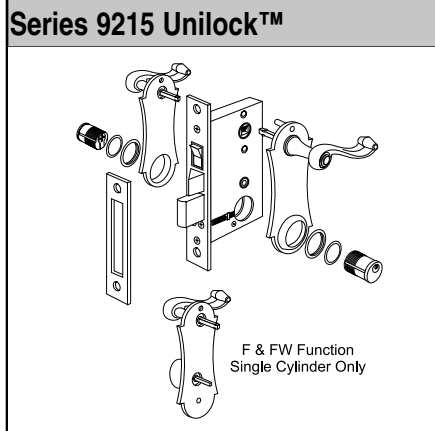
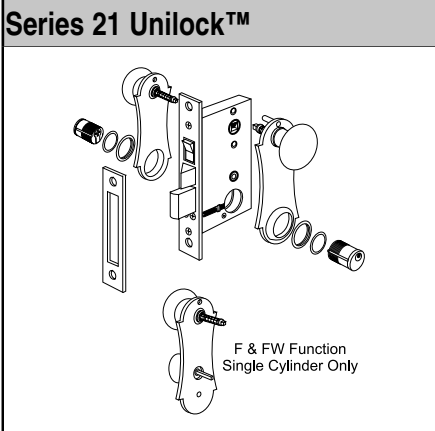

Standard Features		SERIES		
<ul style="list-style-type: none"> • Thru-bolted solid brass trim assemblies • Spring loaded captivated spindles • Reversible mortise lock 1" backset • 1" bolt, 1/2" latch projection • Cylinder: Marks "A" keyway, 5 pin w/ 2 keys; keyed alike - 6 		2750 THINLINE®		
		FINISH GROUPS		
MARKS #	FUNCTION	3	10B	5, 26D
KEYED WITH DEADBOLT				
B	ENTRANCE CYLINDER x TURNPIECE	207	261	233
C	ENTRANCE DOUBLE CYLINDER			
DUMMY TRIM				
DT	FULL DUMMY	125	174	145
ORNAMENTAL IRON LOCKSETS PACKED 6 PER CASE				
OPTIONS - Series 2750		CODE	PRICE	
For 1-3/4" doors		D4	NC	
Marks "C" keyway		G5	16	

Standard Features		SERIES 21 UNILOCK™ SERIES 22			SERIES 9215 UNILOCK™ SERIES 9225		
<ul style="list-style-type: none"> • Door thickness: 1" • Series 9 lock body, Backset: 2-1/2" • Reversible mortise lock 1" bolt, 1/2" latch projection • Lock front Series 7: 1-1/4" x 8"; Series 9: 1-1/16" x 7-5/8" • Thru-bolted solid brass trim assemblies • Spring loaded captivated spindles • Cylinder: Marks "A" keyway, 5 pin w/ 2 keys; keyed alike-6 		FINISH GROUPS					
MARKS #	FUNCTION	3	10B	5, 26D	3	10B	5, 26D
KEYED SINGLE CYLINDER, WITH DEADBOLT							
DW	SINGLE CYL. PANIC PROOF						
F	SINGLE CYL. PANIC PROOF	278	332	296	371	419	390
FW	SINGLE CYL. PANIC PROOF						
KEYED DOUBLE CYLINDER, WITH DEADBOLT							
AC	ENTRANCE	247	304	265	341	390	359
DUMMY TRIM							
DT	FULL DUMMY	165	228	177	265	321	278
ORNAMENTAL IRON LOCKSETS ARE PACKED 6 PER CASE							

OPTIONS	CODE	PRICE
Lock Front: 1" x 7-1/8" standard	W	NC
Mushroom knob interior; 1-7/8" prj.	A9	5
For 1-3/4" doors	D4	NC
Adjustable spring collars	F10	5

How To Order Example for Ornamental Iron Locksets					
9215	C	/	10B	-	D4
1. Lock Series	2. Marks Function	Slash	3. Finish	Dash	4. Options
LOCK SERIES (Pgs. 49 & 50)	MARKS FUNCTION (Pgs. 57-58)		FINISH (Pg. 10)	OPTIONS	
<input type="checkbox"/> 21 <input type="checkbox"/> 2750 <input type="checkbox"/> 22 <input type="checkbox"/> 9215	— B — AC — C — DT — F — DW		<input type="checkbox"/> 3 <input type="checkbox"/> 10B <input type="checkbox"/> 5 <input type="checkbox"/> 26D	<input type="checkbox"/> Special Specify • Keying • Handing • Door Thickness	

ORNAMENTAL IRON

Knob & Lever Kits

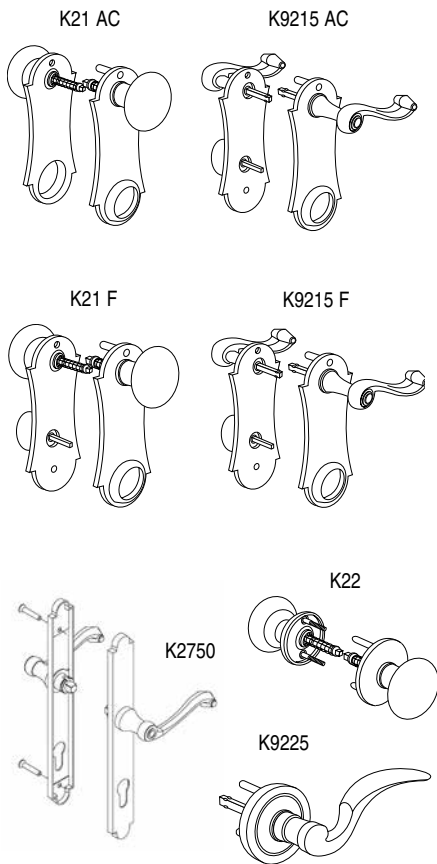

PART #	DESCRIPTION	FUNCTION	FINISH GROUPS			
			3	4	10B	5, 26D
K21AC	Ext./Int. UNILOCK™ knob/plate kit	AC	122	—	159	135
K21AC-M	Ext./Int. UNILOCK™ knob/plate kit (Mushroom Int.)	AC	137	—	164	141
K21F	Ext./Int. UNILOCK™ knob/plate kit assemblies	F	146	—	176	153
K21F-M	Ext./Int. UNILOCK™ knob/plate kit (Mushroom Int.)	F	151	—	182	159
K2750	LEVER PLATE TRIM SET		146	—	189	166
2600B	Thinline lock body, latch, deadbolt US 4 & 26D ONLY - Strike not included		—	121	189	166
K9215AC	Ext./Int. UNILOCK™ lever/plate kit assemblies	AC	184	—	218	195
K9215F	Ext./Int. UNILOCK™ lever/plate kit assemblies	F	184	—	239	216
A9214-M	UNILOCK™ mushroom knob/plate (w/cylinder hole)	AC	68	—	95	71
K9217-M	UNILOCK™ mushroom knob/plate (w/turnpiece)	F	119	—	145	122
K22	Ext./Int. knob/rose kit 1" thru 1-3/4" door		71	—	109	86
K22-M	Ext./Int. knob/rose kit (mushroom int.)		78	—	114	91
K9225	Ext./Int. lever/rose kit		180	—	212	189

Ornamental Iron

Accessories

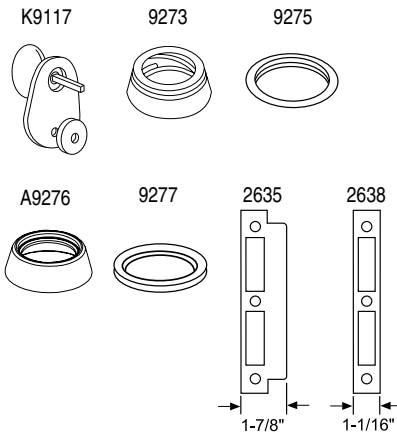

PART #	DESCRIPTION	FINISH GROUPS		
		NO FINISH	3	5, 26D
K9117	Turnpiece kit	—	47	50
A9223-M	Interior knob/rose assembly (mushroom knob)	—	40	47
9273	Spring collar, 7/16" high	—	12	12
9275	Mortise spacer, wrought brass, 1/8" high	—	6	—
A9276	Collar, wrought brass w/insert, 1/2" high	—	21	21
9277	Plastic spacer ring, 1/16"	1	—	—
2635	Curved lip strike, solid brass	—	24	15
2638	Flat strike, solid brass, no lip	—	15	7

Cylinders

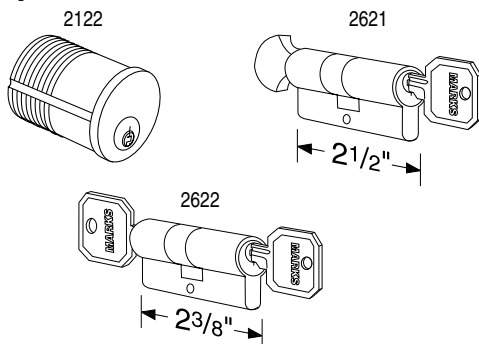

PART #	DESCRIPTION	FINISH GROUPS	
		3	5, 26D
2122-A	5 Pin mortise cylinder, "A" keyway, 15/16"	41	43
2621-A	Cylinder x turnpiece unit, "A" keyway	67	74
2622-A	double cylinder unit, "A" keyway	48	60
2122-C	5 Pin mortise cylinder, "C" keyway	41	43
2621-C	Cylinder x turnpiece unit, "C" keyway	67	74
2622-C	double cylinder unit, "C" keyway	48	60

MORTISE LOCK BODIES

AUTOREVERSE SERIES

GRADE 1
MORTISE LOCKS EXCEEDS
BHMA
SPECIFICATIONS

Mortise Parts, Trim

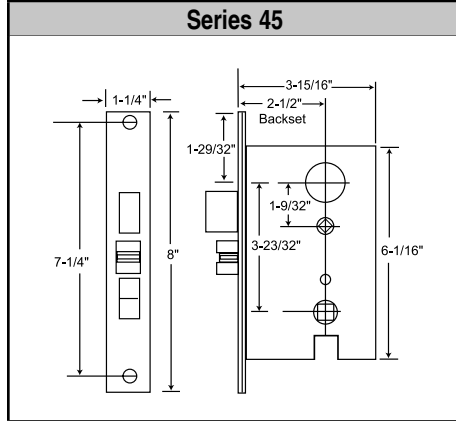
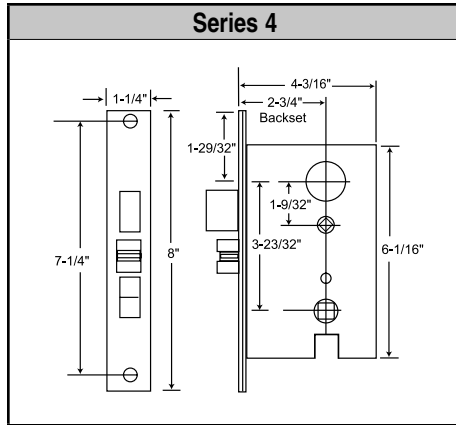

	Standard Features		Grade 1 for Handlesets		
	<ul style="list-style-type: none"> Backset: 4 Series 2-3/4"; 45 Series 2-1/2" Bolt throw: Stainless steel full 1" throw Latch throw: 3/4" (anti-friction) Auxiliary latch: 1/2" throw Case: Stamped steel .090 thick., Zinc dichromate finish Front: 1-1/4" x 8", Adjustable bevel Hubs: Steel, 9/32" on diamond 5/16" on square 		Series 4 • 2-3/4" Backset Series 45 • 2-1/2" Backset 		
MARKS #		FUNCTION	ANSI #	FINISH GROUPS	
				3, 32D	10, 10B, 32

KEYED SINGLE CYLINDER, NO DEADBOLT					
DW	VESTIBULE			378	394
EW	STOREROOM	F07			
EN	STOREROOM				
DN	STOREROOM				
KEYED SINGLE CYLINDER, WITH DEADBOLT					
A	ENTRANCE	F08, F10		389	407
B	ENTRANCE	F21			
F	DORMITORY	F12			
FD	APARTMENT	F20		406	423
KEYED DOUBLE CYLINDER, NO DEADBOLT					
G	ENTRANCE	F09		406	423
KEYED DOUBLE CYLINDER, WITH DEADBOLT					
AC	ENTRANCE	F35		406	423
C	STORE DOOR "B BODY"	F25			
SO	STORE DOOR*	F25			

MORTISE LOCK BODIES ARE PACKED 12 PER CASE

* SERIES 45 NOT AVAILABLE IN "SO" FUNCTION

OPTIONS	CODE	PRICE
1-1/16" x 7-5/8" front	T	28
1-1/16" x 7-3/4" front	V	28
1-1/16" x 8" front	Q	28
Lever support springs w- 5/16" hubs	B4	20
Turnpiece hub on square	B8	12
Screws with Dust Box	B10	NC
Solid latch for electric strike	E1	21
Hold open latch	E2	38
Lead-lined mortise lock	F1	335
4-7/8" Strikes: 1 Left / 1 Right	S6	14

CYLINDER CAMS REQUIRED

Locks w/o deadbolt 2101 Straight Cam
 Locks w/ deadbolt 2102 Cloverleaf Cam
 See pages 41 & 42 for additional cams per function

MORTISE LOCK BODIES

AUTOREVERSE SERIES

GRADE 1
MORTISE LOCKS EXCEEDS
BHMA
SPECIFICATIONS

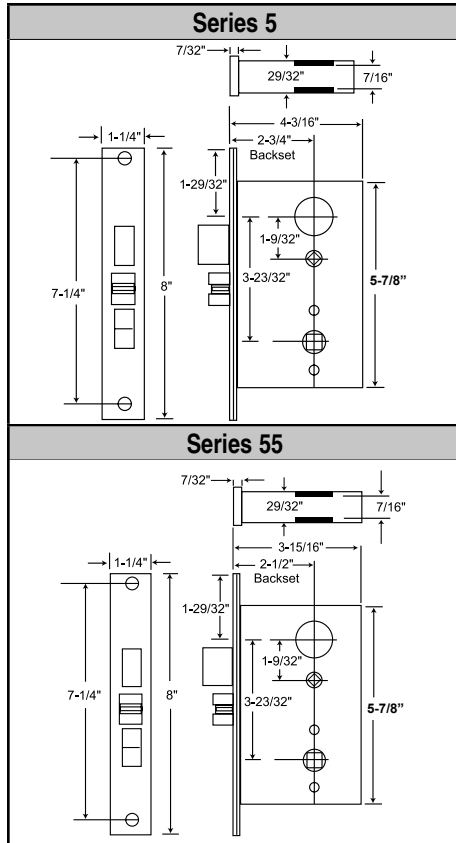

OPTIONS	CODE	PRICE
1-1/16" x 7-5/8" front	T	28
1-1/16" x 7-3/4" front	V	28
1-1/16" x 8" front	Q	28
Lever override guard outside (Series 5)	B1	45
Lever override guard both sides	B2	64
Lever support springs w- 5/16" hubs	B4	20
Hubs with hollow spacer (Series 55)	B6	19
Turnpiece hub on square	B8	12
Screws with Dust Box	B10	NC
Solid latch for electric strike	E1	21
Hold open latch	E2	38
Lead-lined mortise lock	F1	335
4-7/8" Strikes: 1 Left / 1 Right	S6	14
Request to exit switch (Series 5)	W10	140

CYLINDER CAMS REQUIRED	
Locks w/o deadbolt	2101 Straight Cam
Locks w/deadbolt	2102 Cloverleaf Cam
G function (ext. only)	2106 "G" Cam
G function (int. only)	2105 "J" Cam
J function	2105 "J" Cam

* 55 Series Lock Bodies are not available in autoreverse and electrified functions EL and EU.

MARKS #	FUNCTION	ANSI #	Grade 1 for	
			3, 32D	10, 10B, 32
Standard Features • Backset: 5 Series 2-3/4"; 55 Series 2-1/2" • Bolt throw: Stainless steel full 1" throw • Latch throw: 3/4" (anti-friction) • Auxiliary latch: 1/2" throw • Case: Stamped steel .090 thick., Zinc dichromate finish • Front: 1-1/4" x 8", Adjustable bevel • Hubs: Steel, 9/32" on diamond 5/16" on square w/security separator				
Grade 1 for Knobs & Levers Series 5 • 2-3/4" Backset Series 55 • 2-1/2" Backset				
FINISH GROUPS				
KEYED SINGLE CYLINDER, NO DEADBOLT				
D	OFFICE / VESTIBULE		317	415
DW	VESTIBULE			
E, Q, QH	OFFICE	F04		
K	OFFICE	F04		
EW	STOREROOM	F07		
J	CLASSROOM	F05		
JM, JR	HOSPITAL (HOLDBACK)	F06		
GL	INST. PRIVACY	F26		
MT	ArchITech		1146	1168
EL*	ELECTRICALLY LOCKED*		868	887
EU*		ELECTRICALLY UNLOCKED*		
KEYED SINGLE CYLINDER, WITH DEADBOLT				
A	ENTRANCE	F08, F10	333	351
B	ENTRANCE	F21		
F	DORMITORY	F12		
FS	DORMITORY			
FW	DORMITORY	F13		
FD	APARTMENT	F20	357	376
AD		F27		
H	HOTEL	F15		
LH	SPEC. PRIVACY			
KEYED DOUBLE CYLINDER, NO DEADBOLT				
G	ENTRANCE	F09	365	383
GC	INTRUDER LATCHBOLT	F32		
GG	CLASSROOM SECURITY			
GR	CLASSROOM SECURITY w/HOLDBACK			
WW	INSTITUTION	F30		
KEYED DOUBLE CYLINDER, WITH DEADBOLT				
AC	ENTRANCE	F35	365	383
C	STOREROOM	F14		
FC	INTRUDER DEADBOLT	F34		
FA	DORMITORY	F11		
FX	DORMITORY	F33		
KEYLESS				
N	PASSAGE	F01	261	279
L	BATHROOM	F02	333	351
LF	PRIVACY	F19		
LJ	PRIVACY	F19		
EX	EXIT	F31		
MORTISE LOCK BODIES ARE PACKED 6 PER CASE				
* Electrified Functions 5 SERIES ONLY; 2-3/4" Backset ONLY; 100% Duty Cycle 24V/DC, 12V/DC Optional supplied with bridge rectifier (350 ma)				

Mortise Parts, Trim

MORTISE LOCK BODIES

Mortise Parts, Trim

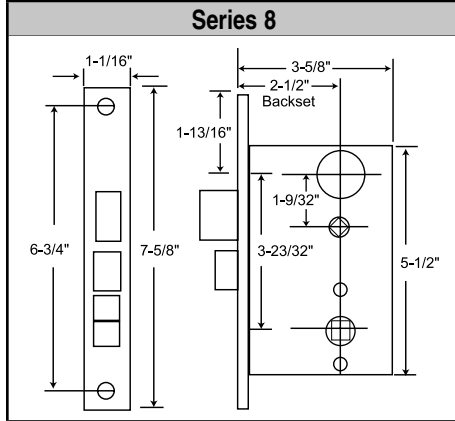
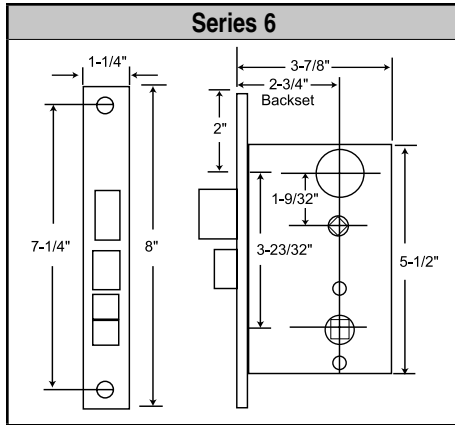

OPTIONS	CODE	PRICE
1-1/16" x 7-5/8" front	T	28
1-1/4" x 10" front, (A function, US 4 only), no mounting holes	U	112
1" x 7-1/8" front, (US 4 only)	W	NC
1-1/4" x 8" front	X	26
1-1/4" x 8-5/8" front (A function, US 4 only)	Y	112
Screws with Dust Box	B10	NC
Solid latch for electric strike	E1	21
4-7/8" Strikes: 1 Left / 1 Right	S6	14
Front 1" x 8"	Z	26

CYLINDER CAMS REQUIRED	
All Functions	2101 Straight Cam

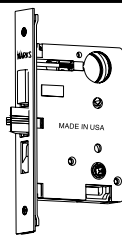
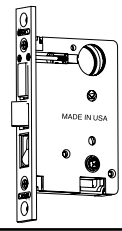
Series 6		Standard Features			
		<ul style="list-style-type: none"> Backset: 2-3/4" Bolt throw: Cast alloy full 1" throw Latch throw: 5/8" (anti-friction) Case: High pressure cast Zamac, baked enamel finish Front: 1-1/4" x 8", Flat or 3° bevel Hubs: 9/32" (7.2mm) on square 			
Series 8		Standard Features			
		<ul style="list-style-type: none"> Backset: 2-1/2" Bolt throw: Cast alloy full 1" throw Latch throw: Solid brass 1/2" throw, reversible Case: High pressure cast Zamac, baked enamel finish Front: 1-1/16" x 7-5/8", Flat or 3° bevel Hubs: 9/32" on square 			
MARKS #		FUNCTION	ANSI #	FINISH GROUPS	
KEYED SINGLE CYLINDER, NO DEADBOLT					
DW	VESTIBULE		322	340	
KEYED SINGLE CYLINDER, WITH DEADBOLT					
A	ENTRANCE	F08, F10	335	352	
B	ENTRANCE	F21			
F	DORMITORY	F12			
KEYED DOUBLE CYLINDER, WITH DEADBOLT					
AC	ENTRANCE	F35	351	369	
C	STORE DOOR "B BODY"	F25			
SO	STORE DOOR	F25			
MORTISE LOCK BODIES ARE PACKED 6 PER CASE					

Grade 2 for
Handlesets

Series 6
2-3/4" Backset
Series 8
2-1/2" Backset

MORTISE LOCK BODIES

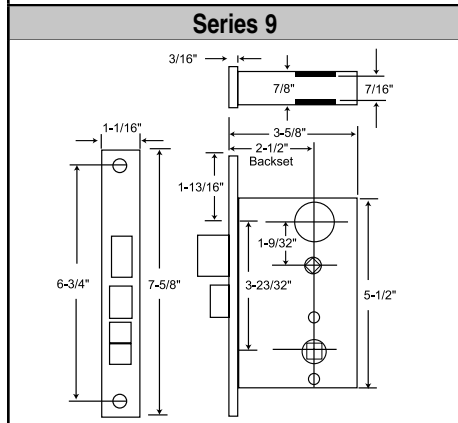
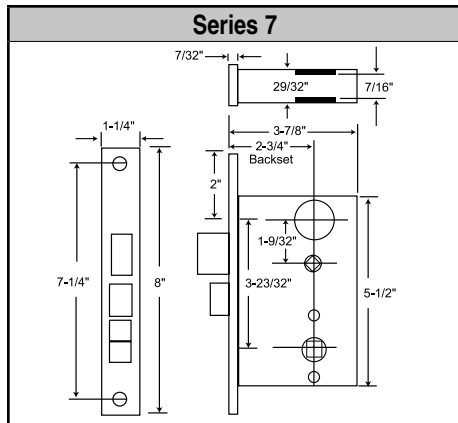

OPTIONS	CODE	PRICE
1-1/16" x 7-5/8" front	T	28
1-1/4" x 10" front, (A function, US 4 only, no mounting holes)	U	112
1" x 7-1/8" front, (US 4 only)	W	NC
1-1/4" x 8" front	X	26
1-1/4" x 8-5/8" front (A function, US 4 only)	Y	112
1-1/16" x 8"	T	
Pin and lever springs	B5	38
Screws with Dust Box	B10	NC
Solid latch for electric strike	E1	21
4-7/8" Strikes: 1 Left / 1 Right	S6	14
Front 1" x 8"	Z	26

CYLINDER CAMS REQUIRED
All functions 2101 Straight Cam

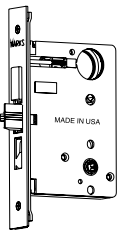
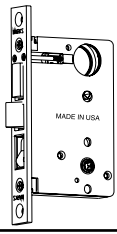
Series 7		Standard Features			
		<ul style="list-style-type: none"> Backset: 2-3/4" Bolt throw: Cast alloy full 1" throw Latch throw: 5/8" (anti-friction) Case: High pressure cast Zamac, baked enamel finish Front: 1-1/4" x 8", Flat or 3° bevel Hubs: 9/32" on square steel, w/ security separator 	Grade 2 for Knobs & Levers Series 7 2-3/4" Backset Series 9 2-1/2" Backset		
		<ul style="list-style-type: none"> Backset: 2-1/2" Bolt throw: Cast alloy full 1" throw Latch throw: Solid brass 1/2" throw, reversible Case: High pressure cast Zamac, baked enamel finish Front: 1-1/16" x 7-5/8", Flat or 3° bevel Hubs: 9/32" on square steel, w/ security separator 			
MARKS #		FUNCTION	ANSI #	FINISH GROUPS	
KEYED SINGLE CYLINDER, NO DEADBOLT					
D	OFFICE / VESTIBULE			3, 32D	10, 10B, 32
DW	VESTIBULE			285	303
KEYED SINGLE CYLINDER, WITH DEADBOLT					
A	ENTRANCE	F08, F10		301	317
B	ENTRANCE	F21			
F	DORMITORY	F12			
FS	DORMITORY				
FW	DORMITORY	F13			
KEYED DOUBLE CYLINDER, WITH DEADBOLT					
AC	ENTRANCE	F35		332	349
C	STOREROOM	F14			
FA	DORMITORY	F11			
FX	DORMITORY	F33			
KEYLESS					
N	PASSAGE	F01		229	246
L	BATHROOM	F02		301	317
LF	PRIVACY	F19			
MORTISE LOCK BODIES ARE PACKED 6 PER CASE					

Mortise Parts, Trim

MORTISE DEADLOCKS

Mortise Parts, Trim

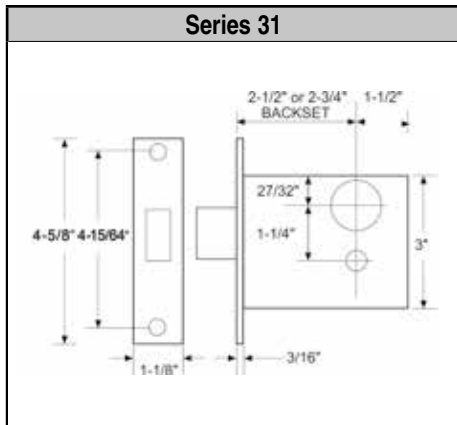

OPTIONS	CODE	PRICE
Security Strike: 4-7/8" x 1-1/4"	S4	12

Standard Features			Series 31 2-3/4" Backset	
<ul style="list-style-type: none"> Backset: Series 31: 2-3/4" Bolt throw: 1" stainless steel with hardened roll pins Case: Stamped Steel, Grade 1 Front: 1-1/16" x 4-5/8" adjustable bevel Cylinder: Solid brass cylinder, 6-pin, "C" keyway, 2 keys Strike: #4035 (Included) 1-1/8" x 3-1/8" Strike: #4035-1 (Optional) 1-1/8" x 3-1/2" 				
			FINISH GROUPS	
MARKS #	FUNCTION	ANSI #	3, 26D	3E, 10, 10B, 26, 32
—	LOCK ONLY	—	186	210
K, 31K	CYLINDER x TURNPIECE	E06071	246	270
L, 31L	COMMUNICATING SINGLE CYL.	E06081	220	244
M, 31M	DOUBLE CYLINDER	E06061	249	279
S, 31S	CLASSROOM (Specify Handing)	E06091	279	304
X, 31X	TURNPIECE ONLY		197	218
MORTISE LOCK BODIES ARE PACKED 6 PER CASE				

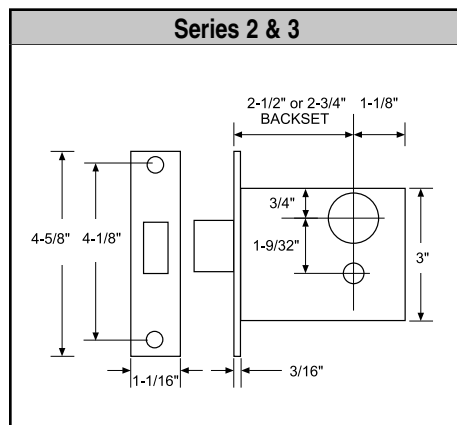

OPTIONS	CODE	PRICE
1-1/16" x 5-5/8" front	R	29

Standard Features			Series 2 • 2-1/2" Backset Series 3 • 2-3/4" Backset	
<ul style="list-style-type: none"> Backset: Series 2: 2-1/2"; Series 3: 2-3/4" Bolt throw: 1" Case: High pressure cast Front: 1-1/16" x 4-5/8" flat or 3" bevel Cylinder: Solid brass cylinder, 6-pin, "C" keyway, 2 keys Strike: #4035 Included 				
			FINISH GROUPS	
MARKS #	FUNCTION	ANSI #	3, 26D	3E, 10, 10B, 26, 32
—	LOCK ONLY	—	131	154
K, 2K, 3K	CYLINDER x TURNPIECE	E06071	192	212
L, 2L, 3L	COMMUNICATING SINGLE CYL.	E06081	168	192
M, 2M, 3M	DOUBLE CYLINDER	E06061	202	223
S, 2S, 3S	CLASSROOM (Specify Handing)	E06091	221	249
X, 2X, 3X	TURNPIECE ONLY		141	162
MORTISE LOCK BODIES ARE PACKED 6 PER CASE				

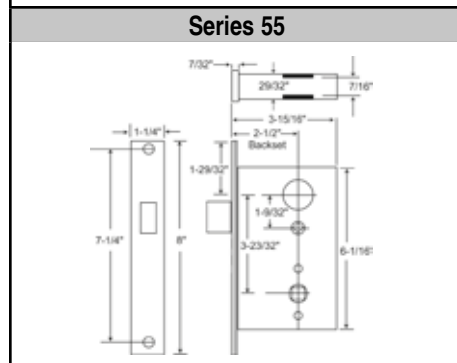
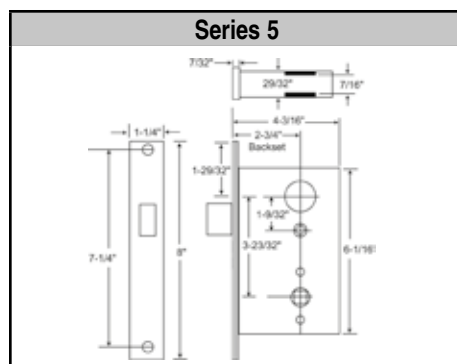

Standard Features			Series 5 • 2-3/4" Backset Series 55 • 2-1/2" Backset	
<ul style="list-style-type: none"> Backset: Series 5: 2-3/4"; Series 55: 2-1/2" Bolt throw: Stainless steel full 1" throw Case: Stamped steel .090 thick, Zinc dichromate finish Front: 1-1/4" x 8" Adjustable bevel 				
			FINISH GROUPS	
MARKS #	FUNCTION	ANSI #	3, 26D	3E, 10, 10B, 32
T, 5T	DOUBLE CYLINDER	F16	375	388
P, 5P	CYLINDER x TURNPIECE	F17	344	367
S, 5S	SINGLE CYLINDER*	F18	317	342
SC, 5SC	CLASSROOM*	F29	367	388
MORTISE LOCK BODIES ARE PACKED 6 PER CASE				
*NOTE: Specify handing on "S" and "SC" functions				

OPTIONS	CODE	PRICE
1-1/16" x 7-5/8" front	T	28
1" x 7-3/4" front	V	28
1" x 1/16" x 8"	Q	28
Lead lined mortise lock	F1	335

MORTISE LOCKSET FUNCTIONS

ANSI #	TYPE	MARKS FUNCTION	ANSI #	TYPE	MARKS FUNCTION	ANSI #	TYPE	MARKS FUNCTION	ANSI #	TYPE	MARKS FUNCTION
F01	Non-Keyed	N	F10	Single Cylinder	A	F19	Non-Keyed	LF	F29	Deadbolt	SC
F02	Non-Keyed	L	F11	Double Cylinder	FA	F20	Single Cylinder	FD	F30	Double Cylinder	WW
F04	Single Cylinder	E	F12	Single Cylinder	F	F21	Single Cylinder	B	F31	Non-Keyed	EX
F05	Single Cylinder	J	F13	Single Cylinder	FW	F22	Non-Keyed	LJ	F32	Double Cylinder	GC
F06	Single Cylinder	JM	F14	Double Cylinder	C	F24	Double Cylinder	C	F33	Double Cylinder	FX
F06	Single Cylinder	JR	F15	Single Cylinder	H	F25	Double Cylinder	C	F34	Double Cylinder	FC
F07	Single Cylinder	EW	F16	Deadbolt	T	F25	Double Cylinder	SO	F35	Double Cylinder	AC
F08	Single Cylinder	A	F17	Deadbolt	P	F26	Single Cylinder	GL			
F09	Double Cylinder	G	F18	Deadbolt	S	F27	Auto Deadbolt	AD			

SINGLE CYLINDER FUNCTIONS

ANSI #	Cam	Strike	Marks Function	
			I/S	O/S
F04: OFFICE Latch by knob/lever either side except when outside knob/lever locked by stop-button in front; then by key outside. Auxiliary latch deadlocks latch. Inside always open.				
	2101	5036		E
F04: OFFICE Latch by knob/lever either side except when outside knob/lever locked by turn piece inside; then by key outside. Auxiliary latch deadlocks latch. Inside always open.				
	2105	5036		K
F05: CLASSROOM Latch by knob/lever either side except when outside knob/lever locked by key. When locked, latch bolt retracted by key. Inside always open. Auxiliary latch deadlocks latch.				
	2105	5036		J
F06: HOLDBACK "A" Latch by knob/lever either side except when outside knob/lever locked or unlocked by key. Auxiliary latch deadlocks latch. Inside always open. Inside knob/lever unlocks outside lever. Latch bolt can be locked in retracted position by locking inside hub. Can be used with blank outside trim.				
	2105	5036		JM
F06: HOLDBACK "B" Latch by knob/lever either side except when outside knob/lever locked or unlocked by key. Auxiliary latch deadlocks latch. Inside always open. Inside knob/lever will not unlock outside knob/lever. Latch bolt can be locked in retracted position by locking outside hub. Can not be used with blank outside trim.				
	2105	5036		JR
F07: STOREROOM Latch by knob/lever inside, key outside. Outside knob/lever always rigid. Auxiliary latch deadlocks latch. Inside always open.				
	2101	5036		EW
F08, F10: ENTRANCE Latch by knob/lever either side except when outside locked by stop-button; then by key outside, knob/lever inside. Deadbolt by key outside, turnpiece inside. Deadbolt deadlocks latch.				
	2102	9035		A
F12: DORMITORY Latch by knob/lever either side except when outside knob/lever locked by stop-button or projected deadbolt. Deadbolt by turnpiece inside. Inside knob/lever retracts latch and deadbolt simultaneously, leaving outside locked. Deadbolt deadlocks latch.				
	2102	9035		F
F13: DORMITORY Latch by knob/lever either side except when projected deadbolt locks outside knob/lever and deadlocks latch. Deadbolt and latch by key outside. Deadbolt by turnpiece inside. Inside knob/lever retracts latch and deadbolt simultaneously, automatically unlocking outside knob/lever.				
	2102	9035		FW
F15: HOTEL Inside knob/lever always free, outside rigid. Latch by knob/lever inside, key outside. (When deadbolt projected by turnpiece all keys are shut out except emergency key). Inside knob/lever retracts deadbolt and latch simultaneously. Auxiliary latch or deadbolt deadlocks latch. Indicator available.				
	2102	5035		H
F20: APARTMENT Latch by knob/lever either side except when outside locked by stop-button or projected deadbolt. Latch deadlocked by auxiliary latch or deadbolt. Deadbolt and latch by key outside. Deadbolt by turnpiece inside. Inside knob/lever retracts latch & deadbolt simultaneously, leaving outside locked.				
	2102	5035		FD

SINGLE CYLINDER FUNCTIONS

ANSI #	Cam	Strike	Marks Function	
			I/S	O/S
F21: ENTRANCE Latch by knob/lever either side. Deadbolt by key outside, turnpiece inside. Deadbolt deadlocks latch.				
	2102	9035		B
F26: INSTITUTIONAL PRIVACY Latch by knob/lever either side except when outside knob/lever locked by inside turn piece. Latch deadlocked by auxiliary latch. Key outside opens latch. When outside locked, inside knob/lever retracts latch, automatically unlocking outside knob/lever.				
	2101	5036		GL
F27: Auto Deadbolt Depressing auxiliary latch projects deadbolt and deadlocks latch. Remains locked even if auxiliary latch is extended. Inside knob/lever retracts both bolts simultaneously. When outside is locked, both bolts are retracted by override key with outside knob/lever.				
	2101	5035		AD
OFFICE VESTIBULE: Latch by knob/lever either side except when outside knob/lever locked by stop-button in front; then by key outside.				
	2101	9035		D
VESTIBULE: Latch by knob/lever inside, key outside. Outside knob/lever always rigid.				
	2101	9035		DW
DORMITORY: Latch by knob/lever inside. Outside knob/lever always rigid. Deadbolt and latch by key outside. Deadbolt by turnpiece inside. When deadbolt is projected, latch is deadlocked. Inside knob/lever retracts latch and deadbolt simultaneously.				
	2102	9035		FS
SPECIAL PRIVACY: Inside knob/lever always free, outside rigid. Latch by knob/lever inside, key outside. Deadbolt by turnpiece inside, emergency release outside. Inside knob/lever retracts deadbolt and latch simultaneously. Auxiliary latch deadlocks latch.				
	2102	5035		LH
STOREROOM: Latch by thumbpiece inside. Key outside.				
	2101	9035		DN
STOREROOM: Latch by thumbpiece or knob/lever inside. Key outside. Auxiliary latch deadlocks latch.				
	2101	5036		EN
ELECTRIFIED FUNCTIONS				
ELECTRICALLY LOCKED (Fail Safe): Outside always locked electrically. Open by key outside, switch or loss of power. Auxiliary latch deadlocks latch. Inside always open.				
	2101	5036		EL
ELECTRICALLY UNLOCKED (Fail Secure): Outside always locked until unlocked by key or electrically energized. Auxiliary latch deadlocks latch. Inside always open.				
	2101	5036		EU







Mortise Parts, Trim

MORTISE LOCKSET FUNCTIONS

DOUBLE CYLINDER FUNCTIONS				
ANSI #	Cam	Strike	Marks Function	
F09: ENTRANCE Latch by knob/lever either side except when outside knob/lever locked by key inside, latch retracted by key outside. Outside remains locked. Auxiliary latch deadlocks latch.	IS 2101 2106	5036	IS O/S	G
F11: DORMITORY Latch by knob/lever either side except when outside knob/lever locked by stop-button or projected deadbolt. Deadbolt by key either side. Inside knob/lever retracts latch and deadbolt simultaneously leaving outside locked. Deadbolt deadlocks latch.	IS 2102	9035		FA
F14: STOREROOM Latch by knob/lever either side. Deadbolt by key either side. Deadbolt deadlocks latch.	IS 2102	9035		C
F24: APARTMENT HANDLE Latch by thumbpiece either side except when outside is locked by key inside. When outside is locked, latch retracted by key outside or thumbpiece inside. Auxiliary latch deadlocks latch.	IS 2101 2106	5036		G
F25: STOREROOM "B" Body Latch by thumbpiece either side. Deadbolt by key either side.	IS 2102	9035		C
F25: STOREROOM Latch by thumbpiece either side except when outside thumbpiece locked by stop-button in front; then by key outside. Deadbolt by key both sides. Deadbolt deadlocks latch.	IS 2102	9035		SO
F30: INSTITUTION Both knob/levers rigid. Auxiliary latch deadlocks latch. Latch by key either side.	IS 2101	5036		WW
F32: INTRUDER LATCH BOLT Latch by knob/lever either side except when outside knob/lever is locked from inside or outside by key. Latch operated by key from inside or outside. Auxiliary latch, deadlocks latch. Inside always open.	IS 2105	5036		GC
CLASSROOM SECURITY Latch bolt retracted by knob/lever from either side unless outside is locked by key from either side. Auxiliary latch deadlocks latch bolt when door is locked. Inside knob/lever is always free for immediate egress.	IS 2101	5036		GG
CLASSROOM SECURITY Latch by lever either side except when outside lever is locked or unlocked by key from either side. With outside locked, exterior key will retract the latch allowing the outside to remain locked. Inside always free for egress. Auxiliary latch deadlocks latch.	IS 2101 2105	5036		GJ
CLASSROOM SECURITY w/HOLDBACK Latch bolt retracted by knob/lever from either side unless outside is locked by key from either side. When locked, latch bolt retracted by key outside or knob/lever inside. Auxiliary latch deadlocks latch bolt when door is locked. Depress inside knob/lever and turn key 360° for holdback feature. Inside knob/lever always free for immediate egress.	IS 2101 2105	5036		GR
F33: DORMITORY Latch by knob/lever either side except when projected deadbolt locks outside knob/lever and deadlocks latch. Deadbolt and latch by key either side. Inside knob/lever retracts latch and deadbolt simultaneously, automatically unlocking outside knob/lever.	IS 2102	9035		FX
F33: DORMITORY Latch by knob/lever either side except when projected deadbolt locks outside knob/lever and deadlocks latch. Deadbolt and latch by key either side. Inside knob/lever retracts latch and deadbolt simultaneously, automatically unlocking outside knob/lever.	IS 2102	5035		FC

DOUBLE CYLINDER FUNCTIONS (Con't)				
ANSI #	Cam	Strike	Marks Function	
F35: STORE DOOR Latch by knob/lever either side except when outside knob/lever locked by stop-button in front; then by key outside. Deadbolt by key either side. Deadbolt deadlocks latch.	IS 2102	9035		AC
NON-KEYED FUNCTIONS				
ANSI #		Strike	Marks Function	
F01: PASSAGE Latch by knob/lever either side.		9035	IS O/S	N
F02: BATHROOM* Latch by knob/lever either side. Deadbolt by turnpiece inside. Deadbolt deadlocks latch. To unlock from outside, remove emergency button, insert emergency key in access hole and turn. Optional coinkey assembly available.		9035		L
F19: PRIVACY* Latch by knob/lever either side except when projected deadbolt locks outside knob/lever and deadlocks latch. Deadbolt by turnpiece inside. Inside knob/lever retracts latch and deadbolt simultaneously, automatically unlocking outside knob/lever. To unlock from outside, remove emergency button, insert emergency key in access hole and turn. Optional coinkey assembly available.		9035		LF
F22: PRIVACY Latch by knob/lever either side except when outside knob/lever is locked by inside turnpiece. Turning inside knob/lever or closing door unlocks outside lever. To unlock from outside, remove emergency button, insert emergency key in access hole and turn. Optional coinkey assembly available.		9035		LJ
F31: EXIT Latch by knob/lever inside, no trim outside. Auxiliary latch deadlocks latch. None removable blank trim: F26 option		5036		EX
DEADBOLT FUNCTIONS				
	IS	Cam		
F16: DEADLOCK Deadbolt by key either side.	2102	2102	9035	T
F17: DEADLOCK Deadbolt by key outside and turnpiece inside.		2102	9035	P
F18: DEADLOCK Deadbolt by key one side only.		2102	9035	S
F29: DEADLOCK Deadbolt by key outside. Inside turnpiece will retract but will not project deadbolt.		2102	9035	SC
DEADBOLT Latch by knob/lever either side. Deadbolt by key either side; latch remained unlocked at all times. Note: With this function deadbolt protrusion is 13/16		2102	9035	CT
DEADBOLT FUNCTIONS				
E06072: CYLINDER BY TURNPIECE Deadbolt by inside turnpiece or outside key.		2102		K
E06082: COMMUNICATING SINGLE CYLINDER* Deadbolt by key from one side only.		2102		L
E06062: DOUBLE CYLINDER Deadbolt by key either side.		2102		M
E06092: CLASSROOM Deadbolt by outside key. Turnpiece will retract but not project deadbolt.		2102		S
TURNPIECE Deadbolt by inside turnpiece.		2102		X
*PRIVACY INDICATOR AVAILABLE				

MORTISE LOCKSET PARTS RK, RL

ROSES	RR: 2-9/16" dia.	RW: 2-9/16" dia.	RQ: 2-1/4" dia.	RS: 2-1/4" dia.	RX: 2-1/2" sq.	*RK: 2-1/2" sq.	*RL: 2-1/2" sq.
					 Wrought	 Forged	 Forged

Knob / Rose Kits

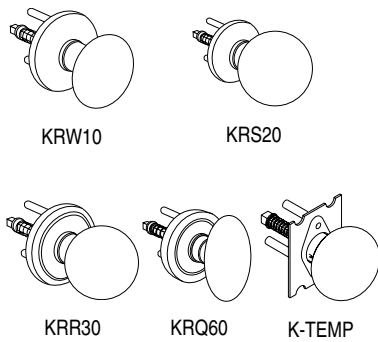

ROSE WITH RING	PLAIN ROSE	SMALL ROSE W/RING	SMALL ROSE	DESCRIPTION	FINISH GROUPS						ROSE RK*
					3	3E	10, 10B	15	26	32D	
KRR10	KRW10	KRQ10	KRS10	Round knob/ball assembly	201	—	—	—	—	201	+109
KRR20	KRW20	KRQ20	KRS20	Ball knob/ball assembly							
KRR30	KRW30	KRQ30	KRS30	Ball knob/ball assembly	—	218	259	293	293	—	
KRR60	KRW60	KRQ60	KRS60	Eclipse knob/ball assembly							
NO FINISH											
K-TEMP				Temporary Trim	68						
K-TEMP-G3				Temporary Trim less cyl	52						

Complete knob/rose assemblies both sides (includes spindles).

Lever / Rose Kits

* Specify handing

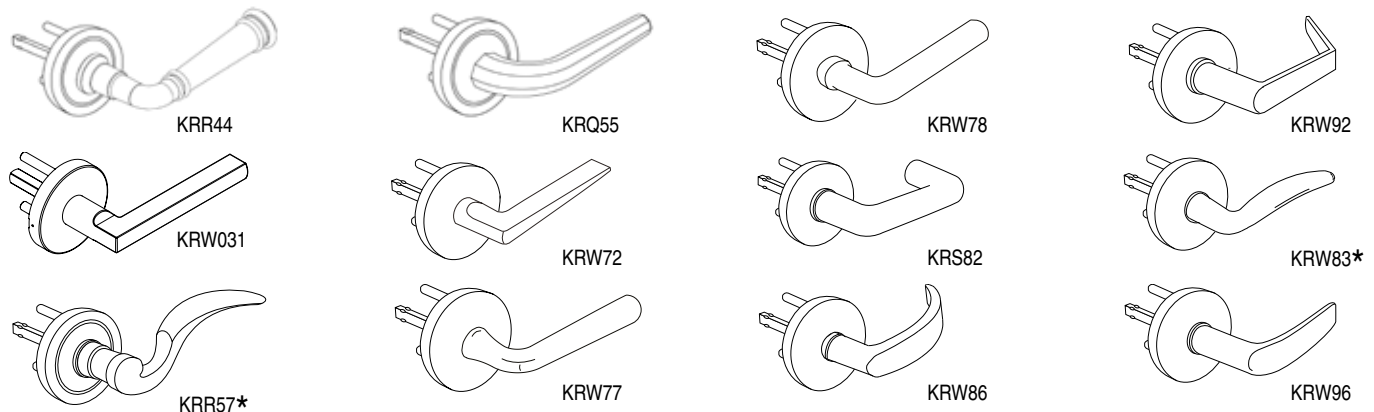

PART #		DESCRIPTION	FINISH GROUPS						ROSE RK*	ROSE RL*		
ROSE WITH RING RR	SMALL ROSE WITH RING RQ		3E	4	26D	15	10, 10B, 10E, 26	32D				
		Complete lever/rose assemblies both sides (includes spindles).										
KRR44	KRQ44	Stanhope lever/rose kit	214	321	321	321	321	—	+109 FOR ALL FINISHES	+32 FOR ALL FINISHES		
KRR57	KRQ57	Monaco lever/rose kit	214	321	321	321	—	—				
KRR55	KRQ55	Brompton lever/rose kit	214	321	321	321	—	—				
		Complete lever/rose assemblies both sides (includes spindles).										
PLAIN ROSE RW	SMALL ROSE RS	KRW031	KRS031	Copa lever/rose kit	321	321	—	321	321	321	+109 FOR ALL FINISHES	32 FOR ALL FINISHES
KRW72	KRS72	Towne lever/rose kit	321	321	321	321	364	—				
KRW77	KRS77	Maxwell lever/rose kit	321	321	321	321	364	342				
KRW78	KRS78	Omni lever/rose kit	321	321	321	321	364	342				
KRW82	KRS82	Plaza lever/rose kit	321	321	321	321	364	342				
KRW83	KRS83	Dayton lever/rose kit	321	321	321	321	364	342				
KRW86	KRS86	Crescent lever/rose kit	321	321	321	321	364	—				
KRW92	KRS92	American lever/rose kit	321	321	321	321	364	342				
KRW96	KRS96	Titan lever/rose kit	321	321	321	321	364	342				

FOR ADDITIONAL DESIGNS, ASK FOR THE CUSTOM LOCK DIVISION CATALOG OR VISIT OUR WEBSITE @ WWW.MARKSUSA.COM

1-800-645-9445 • Fax 631-225-6136 • ©2019 MARKS USA

MORTISE LOCKSET PARTS

Dummy Cylinder, Collars & Turnpieces

Mortise Parts, Trim

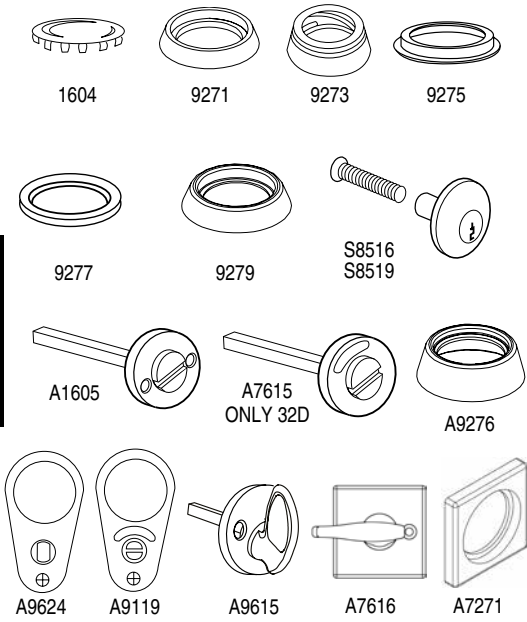

PART #	DESCRIPTION	FINISH GROUPS					
		3E	3, 26D	4	10, 10B, 26	32	32D
1604	Emergency hole cover	—	10	—	—	—	—
9271	Tapered collar, solid brass, 5/16" high	32	224	—	24	28	24
9273	Spring collar, 7/16" high	—	15	—	—	—	—
9275	Mortise spacer, wrought brass, 1/8" high	—	9	—	—	—	—
9277	Plastic spacer ring, 1/16"	7	—	—	—	—	—
9279	Tapered collar, wrought brass, 3/8" high	22	17	—	22	19	17
S8516	Dummy cylinder, inside	42	42	—	42	—	—
S8519	Dummy cylinder, outside	42	42	—	42	—	—
A1605	Emergency coinkey	71	65	65	65	—	—
A7271	Square cylinder collar, 1-3/4" x 5/16"	43	37	—	37	37	37
A7615	Occupancy indicator	—	—	—	—	—	54
A7616	Square Turnpiece Rose	77	59	77	68	68	68
A9276	Collar, wrought brass w/insert, 1/2" high	—	22	—	30	30	30
A9624	Hotel indicator plate ass'y for rose trim	92	68	—	73	—	—
A9119	Occupancy indicator plate ass'y for rose trim	—	105	—	—	—	—
A9615	Turnpiece	66	47	66	56	66	56

Strikes

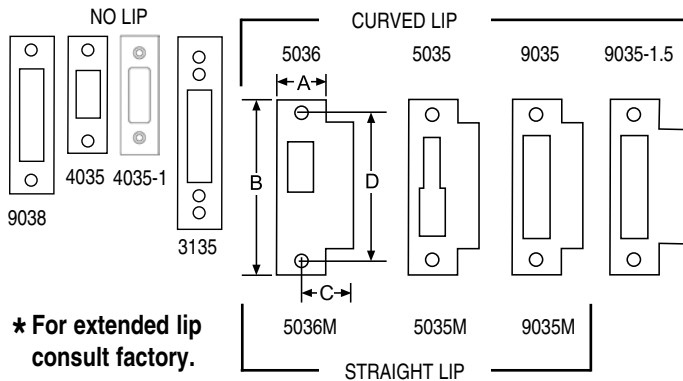

TYPE	PART #	A	B	C*	D	FINISH GROUPS	
						S3	3, 10, 10B, 32, 32D
No Lip	4035	1-1/8"	3-1/8"	—	—	9	17
	4035-1	1-1/8"	3-1/2"	3-1/2"	2-1/2"		
	9038	1-1/8"	4-7/8"	—	2-1/2"	10	—
	3135	1-1/4"	4-7/8"	—	—	—	22
Curved Lip	5035 †	1-1/4"	4-7/8"	1-1/4"	4-1/8"	—	24
	5036 †	1-1/4"	4-7/8"	1-1/4"	4-1/8"	—	24
	9035	1-1/4"	4-7/8"	1-1/4"	4-1/8"	9	24
	9035-1.5	1-1/4"	4-7/8"	1-1/2"	4-1/8"	—	37
Straight Lip	5035M †	1-1/4"	4-7/8"	7/8"	4-1/8"	—	29
	5036M †	1-1/4"	4-7/8"	7/8"	4-1/8"	—	29
	9035M	1-1/4"	4-7/8"	7/8"	4-1/8"	—	29
Dust Box	9036	Dust box for 9038 strike, plastic				9	—
	4036	Dust box for 4035 strike, plastic				7	—

† Specify handing.
Extended lip strikes from 1-1/4" - 2", Add \$16.

*Extended lip strikes over 2", consult factory.

Spindles

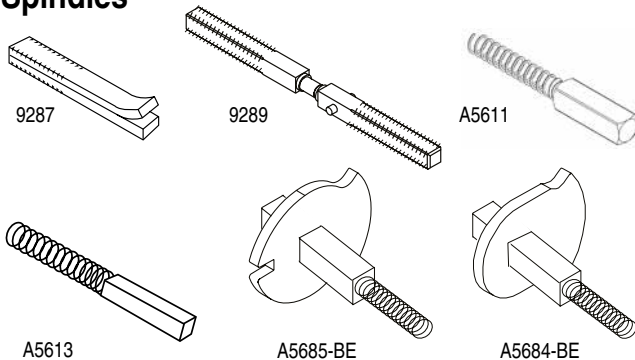

PART #	DESCRIPTION	
9287	2-1/2" LONG, HOOK SPINDLE, 2 PIECE	15
9289	4-3/4" LONG, SWIVEL SPINDLE	15
A5611	SPINDLE/SPRING ASSEMBLY FOR LEVERS, 5/16", 1" L	15
A5613	SPINDLE/SPRING ASSEMBLY FOR LEVERS, 5/16", 1-5/8" L	15
A5685-BE	CAM/SPINDLE SPRING ASSEMBLY EXTERIOR	24
A5684-BE	CAM/SPINDLE SPRING ASSEMBLY INTERIOR	24

TRIM LOCK PARTS

How to Order Example for Knob & Lever Assemblies							
DV	02	-	30	/	15	-	G3
1. <i>Plate/Rose Design</i>	2. <i>Trim Description</i>	<i>Dash</i>	3. <i>Knob/Lever Design</i>	<i>Slash</i>	4. <i>Finish</i>	<i>Dash</i>	5. <i>Options</i>

PLATE/ROSE DESIGN	TRIM DESCRIPTION	KNOB DESIGN	FINISH	OPTIONS
<input type="checkbox"/> BA <input type="checkbox"/> RR <input type="checkbox"/> CL <input type="checkbox"/> RW <input type="checkbox"/> CP <input type="checkbox"/> RQ <input type="checkbox"/> CR <input type="checkbox"/> RS <input type="checkbox"/> DR <input type="checkbox"/> RX <input type="checkbox"/> DV <input type="checkbox"/> GC <input type="checkbox"/> MA <input type="checkbox"/> NY <input type="checkbox"/> NS <input type="checkbox"/> TN	<input type="checkbox"/> 01 Outside knob/lever/cylinder <input type="checkbox"/> 02 Inside knob/lever/turnpiece <input type="checkbox"/> 03 Inside knob/lever/cylinder <input type="checkbox"/> 04 Inside knob/lever only <input type="checkbox"/> 05 Outside cylinder only <input type="checkbox"/> 06 Outside knob/lever /emergency coinkey <input type="checkbox"/> 07 Outside hotel <input type="checkbox"/> 08 Outside knob/lever only	<input type="checkbox"/> 10 <input type="checkbox"/> 20 <input type="checkbox"/> 30 <input type="checkbox"/> 60 LEVER DESIGN <input type="checkbox"/> 44 <input type="checkbox"/> 82 <input type="checkbox"/> 55 <input type="checkbox"/> 83 <input type="checkbox"/> 57 <input type="checkbox"/> 86 <input type="checkbox"/> 72 <input type="checkbox"/> 92 <input type="checkbox"/> 77 <input type="checkbox"/> 96 <input type="checkbox"/> 78 <input type="checkbox"/> 031	<input type="checkbox"/> 3 <input type="checkbox"/> 3E <input type="checkbox"/> 4 <input type="checkbox"/> 10 <input type="checkbox"/> 10B <input type="checkbox"/> 15 <input type="checkbox"/> 26 <input type="checkbox"/> 26D <input type="checkbox"/> 32D <input type="checkbox"/> Special	<hr/> <hr/> <hr/> <hr/> <hr/> <hr/> <hr/> <hr/> Specify <ul style="list-style-type: none"> • Keying • Handing • Door Thickness





Mortise Parts, Trim





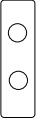

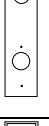
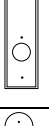

How to Order Example for Handle Assemblies				
CR41-39/15	/	15	-	G3
1. <i>Handle Assembly Design</i>	<i>Slash</i>	2. <i>Finish</i>	<i>Dash</i>	3. <i>Options</i>

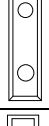
PLATE/ROSE DESIGN	FINISH	OPTIONS
<input type="checkbox"/> CR41-39 Crown <input type="checkbox"/> TN41-39 Towne	<input type="checkbox"/> 3E <input type="checkbox"/> 15 <input type="checkbox"/> Special	<hr/> <hr/> <hr/> <hr/> <hr/> <hr/> <hr/> <hr/> Specify <ul style="list-style-type: none"> • Keying • Handing • Door Thickness

TRIM LOCK PARTS

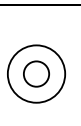
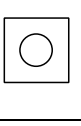

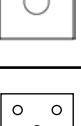













Mortise Parts, Trim

PLATE/ROSE DESIGN	3	3E	10	10B	15	26D	32D
BARRIER BA 	—	—	—	—	—	—	236
CLASSIC CL 	82	—	82	82	—	83	97
CAPITOL CP 	133	—	131	131	—	—	122
CROWN CR 	18	—	192	192	168	168	168
DRAKE DR 	203	—	221	221	203	203	210
DAVOS DV 	274	—	298	298	274	274	—
MADISON MA 	—	220	—	—	257	—	—
SCHOOL LA 	—	—	—	—	—	—	192

PLATE/ROSE DESIGN	3	3E	10	10B	15	26D	32D	
NEW YORKER NY 10" PLATE 	47	—	—	—	—	58	—	
NEW YORKER NS 7" PLATE 	35	—	—	—	—	47	—	
TOWNE TN 	—	220	—	—	259	—	—	
2-9/16" DIA. ROSE W-RING RR 	111	145	134	14	123	111	111	
2-9/16" DIA. PLAIN ROSE RW 	111	145	134	134	123	111	111	
2-1/4" DIA. SMALL ROSE W-RING RQ 	111	145	134	134	123	111	111	
2-1/4" DIA. SMALL ROSE RS 	111	145	134	134	123	111	111	
2-1/2" SQ. SQUARE ROSE RX 	111	145	134	134	123	111	111	
2-1/2" SQ. SQUARE ROSE RK 	OUTSIDE	186	218	207	207	197	186	186
	INSIDE	190	230	219	219	208	198	198
SQUARE TURNPIECE ROSE A7616 	61	77	68	68	68	68	68	
2-1/2" SQ. SQUARE ROSE RL 	198	230	219	219	208	198	198	

TRIM LOCK PARTS

Knob / Lever Design

KNOB/LEVER	FINISH GROUPS									
	3	3E	4	10	10B	15	26	26D	32D	
ROUND KNOB  10	99	—	—	121	121	—	121	121	99	
BALL KNOB  20	99	—	—	121	121	—	121	121	99	
BALL KNOB  30	—	168	—	121	—	211	211	—	—	
ECLIPSE KNOB  60	—	168	—	—	—	211	205	211	—	
STANHOPE LEVER  44	—	202	202	222	222	202	222	202	198	
COPA LEVER  031	168	202	202	222	222	202	222	202	—	
MONACO LEVER  57	—	202	202	222	222	202	222	202	—	
BROMPTON LEVER  55	—	202	202	222	222	202	222	202	—	
TOWNE LEVER  72	168	202	202	222	222	202	222	202	—	
MAXWELL LEVER  77	168	202	202	222	222	202	222	222	198	
OMNI LEVER  78	168	202	202	222	222	202	222	202	—	
PLAZA LEVER  82	168	202	202	222	2222	202	222	202	198	
DAYTON LEVER  83	168	202	202	222	222	202	222	202	202	
CRESCENT LEVER  86	168	202	202	222	222	202	222	202	198	
AMERICAN LEVER  92	168	202	202	222	222	202	222	202	198	
TITAN LEVER  96	168	202	202	222	222	202	222	202	198	

Mortise Parts, Trim

TRIM LOCK PARTS

Handle Design

CR41-39 Crown

16" x 3-7/32" x 11/16"

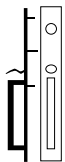

3E

490

15

550

TN41-39 Towne

16-3/8" x 2-1/4" x 3/8"

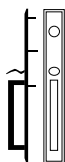

3E

490

15

550

Mortise Parts, Trim

MORTISE DOOR ACCESSORIES

Recess Stainless Steel Door Pulls

TP015



TP046



MARKS #	PRICE
TP015	33
TP046	33

How To ORDER CYLINDRICAL LOCKSETS

How To Order Example for Cylindrical Locksets					
195	N	/	26D	—	G3
<i>1. Lockset Series</i>	<i>2. Marks Function</i>	<i>Slash</i>	<i>3. Finish</i>	<i>Dash</i>	<i>4. Options</i>

1	SERIES
Cylindrical Locksets:	110, 110R, 210, 210R, 180, 180R, 280, 280R, 175, 175R, 195, 195R, 295, 295R, 495, 495R

2	CYLINDRICAL FUNCTIONS		
MARKS #	FUNCTION	ANSI	
#			
N	—	PASSAGE	F75
L	—	PRIVACY	F76
LK	—	HOSPITAL/PRIVACY	F76 MOD.
P	—	PATIO	F77
DC	RDC	COMMUNICATING	F80
A	RA	ENTRY	F81
B	RB	ENTRY	F82A
AQ	—	EXIT	F83
S	RS	CLASSROOM	F84
F	RF	STOREROOM	F86
DW	RDW	INSTITUTION	F87
DA	RDA	VESTIBULE	F88
FQ	—	EXIT	F89
T	RT	CORRIDOR	F90
TK	—	HOSPITAL/PRIVACY	F90 MOD.
GB	RGB	STORE DOOR (95 SERIES ONLY)	F91
BS	—	SERVICE STATION LOCK	F92
H	—	HOTEL	F93
AB	RAB	ENTRANCE	F109
DB	RDB	CLASSRM. INTRUDER	F110
NB	—	COMMUNICATING PASSAGE	F111
FB	—	COMMUNICATING STOREROOM	F112
SB	RSB	COMMUNICATING CLASSROOM	F113
FEL	RFEL	ELECTRONICALLY LOCKED	
FEU	RFEU	ELECTRONICALLY UNLOCKED	
DUMMY TRIM			
DO		DUMMY TRIM OUTSIDE	
DT		FULL DUMMY	

3	FINISH	
MARKS #	Description	ANSI #
US 3	Polished Brass, Clear Coated	605
US 4	Satin Brass, Clear Coated	606, 606E
US 10	Satin Bronze, Clear Coated	612E
US 10B	Dark Bronze, Clear Coated	613E
US 26	Polished Chrome, Plated	625
US 26D	Satin Chrome, Plated	626
US 32	Polished Stainless Steel	629
US 32D	Satin Stainless Steel	630

4	OPTIONS		
TRIM MODIFICATIONS			
	CODE	PRICE	
Tactile knob/lever, coated ext. only	A1	62	
Tactile knob/lever, knurled	A4	62	
Tactile knob/lever, coated int. & ext.	A18	126	
DOOR THICKNESS			
	CODE	PRICE	
2" (50 mm)	D1	NC	
2-1/4" (57mm)	D2	75	
Over 2-3/8" - 4"	D9	667	
LATCH			
	CODE	PRICE	
2-3/4" backset, 1-1/8" x 2-1/4" face	E4	NC	
2-3/8" backset, 1" x 2-1/4" face	E6	NC	
2-3/4" backset, 9/16" throw, Gr. 1, UL Listed	E7	48	
5" backset, 9/16" throw, Gr. 1	E9	48	
3-3/4" backset, 9/16" throw, Gr. 1	E10	48	
2-3/8" backset, 1-1/8" x 2-1/4" face	E11	13	
2-3/4" backset, 1" x 2-1/4" face	E12	13	
TRIM CHANGES			
	CODE	PRICE	
Yale conventional	F7	24	
Sargent conventional cylinder	F8	24	
Corbin conventional cylinder	F9	24	
Corbin 6 pin IC core	F12	35	
Corbin 7 pin IC core	F13	35	
Yale 6 pin IC core	F14	24	
Yale 7 pin IC core	F15	24	
Schlage 6 pin IC core	F19	24	
Sargent IC core	F20	24	
Medeco IC core large format	F21	24	
CYLINDER			
	CODE	PRICE	
Special optional keyway	G2	38	
Less cylinder	G3	Deduct 15	
STRIKE			
	CODE	PRICE	
4-7/8" ASA strike	S1	14	
2-3/4" "T" strike	S3	NC	

80 LINE GRADE 1 CYLINDRICAL KNOBSETS

BHMA CERTIFIED		ANSI-A156.2 • Grade 1 3 Hour Fire Rating		Series 180/180R • 2-3/4" Backset Series 280/280R • 2-3/4" Backset	
80 Series Knobsets Shown Below				Standard Features	
				<ul style="list-style-type: none"> • Backset: 2-3/4" • Latch #1834, Front: 1-1/8" x 2-1/4" • Throw: 9/16"; Stainless steel nose • Knobs: 2-1/4" dia. (180) round; 2-3/16" dia. (280) ball • Roses: Adjustable both sides; Steel reinforced 2-3/4" dia. • Strike: #1135, 4-7/8" ASA curved lip strike • Door thickness: 1-5/8" to 1-7/8" • Cylinder: MARKS "C" keyway, 6 pin w/ 2 keys 	
MARKS #		FUNCTION	ANSI #	FINISH GROUPS	
COMM. CYL.	IC CORE CYL.*			3 ❖, 32D	10, 10B, 32
N	—	PASSAGE	F75	447	487
L	—	PRIVACY	F76	451	491
P	—	PATIO	F77	451	491
DC	RDC ❖	COMMUNICATING	F80	523	563
A	RA ❖	ENTRY	F81	475	515
B	RB ❖	ENTRY	F82A	475	515
AB	RAB ❖	ENTRY	F109	475	515
AQ	—	EXIT	F83	462	503
S	RS ❖	CLASSROOM	F84	475	515
F	RF ❖	STOREROOM	F86	475	515
DW	RDW ❖	INSTITUTION	F87	523	563
DA	RDA ❖	VESTIBULE	F88	523	563
FQ	—	EXIT	F89	462	503
TK	—	HOSPITAL/PRIVACY MOD.	F90	487	526
BS	RBS ❖	SERVICE STATION LOCK	F92	488	527
DO	—	DUMMY TRIM OUTSIDE	—	270	290
DT	—	FULL DUMMY TRIM	—	372	412
NB	—	COMMUNICATING PASSAGE	F111	410	431
FB	RFB ❖	COMMUNICATING STOREROOM	F112	471	491
SB	RSB ❖	COMMUNICATING CLASSROOM	F113	471	491

KNOBS ARE PACKED 12 PER CASE

NOTE: Split designs and/or finishes are priced at the highest design and/or finish • Special finishes, consult factory
 • IC Core Models: Tailpieces included, core not included
 ❖ IC Core Models in US3 Finish: Add \$42.00 to list price

OPTIONS	CODE	PRICE
For 2" doors	D1	NC
For 2-1/4" doors	D2	77
2-3/8" backset, 1" x 2-1/4" face	E6	NC
5" backset, 9/16" throw, Gr. 1	E9	48
3-3/4" backset, 9/16" throw, Gr. 1	E10	48
Less cylinder	G3	Deduct 16
2-3/4" "T" strike	S3	NC

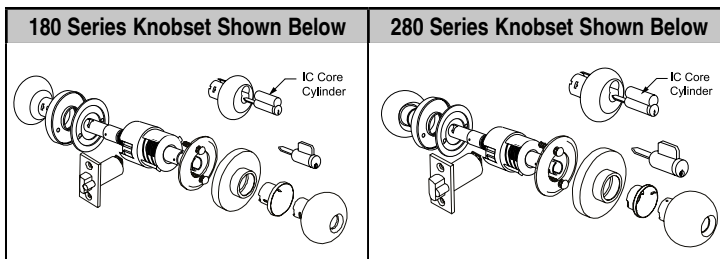

★Standard & HI-SECURITY™ IC Core Models:

Interchangeable Core models for 6 or 7 pin cores (not included).

Accepts: Marks, Marks HI-SECURITY™, Medeco®, KeyMark™, Falcon, Schlage® small format & Best®. **IC Core Tailpieces ARE Included.**

10 LINE GRADE 2 CYLINDRICAL KNOBSETS

BHMA CERTIFIED		ANSI-A156.2 • Grade 2 Plus 3 Hour Fire Rating		Series 110/110R • 2-3/8" Backset Series 210/210R • 2-3/8" Backset		
10 Series Knobsets Shown Below				Standard Features		
				<ul style="list-style-type: none"> • Backset: 2-3/8" • Latch #1138, Front: 1" x 2-1/4"; Throw: 1/2"; Stainless steel nose • Knobs: 2-1/4" dia. (110) round; 2-3/16" dia. (210) ball • Roses: Adjustable both sides; Steel reinforced 2-3/4" dia. • Strike: #1136, 2-3/4" "T" strike • Door thickness: 1-5/8" to 1-7/8" • Cylinder: MARKS "C" keyway, 6 pin w/ 2 keys 		
MARKS #			FUNCTION	ANSI #	FINISH GROUPS	
COMM. CYL.	IC CORE CYL.*	3❖, 32D			10, 10B, 32	
N	—	PASSAGE	F75	151	193	
L	—	PRIVACY	F76	181	221	
P	—	PATIO	F77	181	224	
DC	RDC ❖	COMMUNICATING	F80	242	283	
A	RA ❖	ENTRY	F81	214	254	
B	RB ❖	ENTRY	F82A	214	254	
AB	RAB ❖	ENTRY	F109	214	254	
AQ	—	EXIT	F83	200	240	
S	RS ❖	CLASSROOM	F84	214	254	
F	RF ❖	STOREROOM	F86	214	254	
DW	RDW ❖	INSTITUTION	F87	243	284	
DA	RDA ❖	VESTIBULE	F88	243	284	
FQ	—	EXIT	F89	200	240	
DO	—	DUMMY TRIM OUTSIDE	—	158	178	
DT	—	FULL DUMMY TRIM	—	166	205	
NB	—	COMMUNICATING PASSAGE	F111	162	182	
FB	RFB ❖	COMMUNICATING STOREROOM	F112	227	251	
SB	RSB ❖	COMMUNICATING CLASSROOM	F113	227	251	

KNOBS ARE PACKED 12 PER CASE

NOTE: Split designs and/or finishes are priced at the highest design and/or finish • Special finishes, consult factory
 • IC Core Models: Tailpieces included, core not included
 ❖ IC Core Models in US3 Finish: Add \$42.00 to list price

OPTIONS	CODE	PRICE
For 2" doors	D1	NC
For 2-1/4" doors	D2	77
2-3/4" backset, 1-1/8" x 2-1/4" face	E4	NC
2-3/4" backset, 9/16" throw, Gr. 1, UL Listed	E7	48
Solid latch for electric strike	E9	48
3-3/4" backset, 9/16" throw, Gr. 1	E10	48
Less cylinder	G3	Deduct 16
4-7/8" ASA strike with curved lip	S1	14

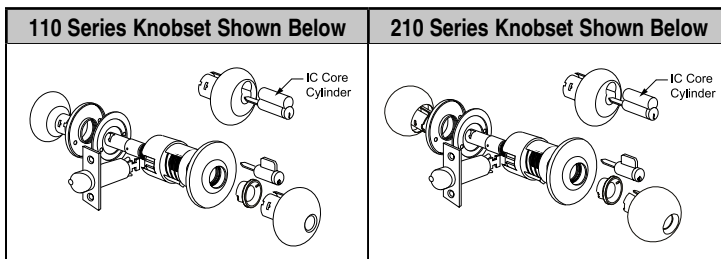



★ Standard & HI-SECURITY™ IC Core Models:

Interchangeable Core models for 6 or 7 pin cores (not included).

Accepts: Marks, Marks HI-SECURITY™, Medeco®, KeyMark™, Falcon, Schlage® small format & Best®. **IC Core Tailpieces ARE Included.**

95 LINE GRADE 1 CYLINDRICAL SURVIVOR LEVERSETS

BHMA CERTIFIED			ANSI-A156.2 • Grade 1 3 Hour Fire Rating		SURVIVOR SERIES Series 195/195R, 295/295R, 495/495R • 2-3/4" Backset	
95 Series Leversets Shown Below				Standard Features		
				<ul style="list-style-type: none"> • Backset 2-3/4" • Latch #1834, Front: 1-1/8" x 2-1/4"; Throw: 9/16"; Stainless steel nose • Levers: Solid cast Zamac; w/ 1/2" return (except 395 & 495) • Roses: Thru-bolted, 3-7/16" dia., spring loaded 2-#10 thru-bolts • Strike: #1135, 4-7/8" ASA curved lip strike • Door thickness: 1-5/8" to 1-7/8"; For 1-3/8" door use K1904 spacer • Cylinder: MARKS "C" keyway, 6 pin w/ 2 keys 		
MARKS #		FUNCTION	ANSI #	FINISH GROUPS		
COMM. CYL.	IC CORE CYL.*			3, 26D	4, 10, 10B, 26	
N	—	PASSAGE	F75	428	511	
L	—	PRIVACY	F76	452	540	
LK	—	HOSPITAL/PRIVACY	F76 MOD.	482	568	
P	—	PATIO	F77	447	534	
DC	RDC	COMMUNICATING	F80	519	603	
A	RA	ENTRY	F81	471	557	
B	RB	ENTRY	F82A	471	557	
AB	RAB	ENTRY	F109	471	557	
AQ	—	EXIT	F83	457	545	
S	RS	CLASSROOM	F84	471	557	
F	RF	STOREROOM	F86	471	557	
DW	RDW	INSTITUTION	F87	519	603	
DA	RDA	VESTIBULE	F88	519	603	
FQ	—	EXIT	F89	457	545	
T	RT	CORRIDOR	F90	482	568	
TK	—	HOSPITAL/PRIVACY	F90 MOD.	447	534	
GB	RGB	STORE DOOR	F91	640	698	
BS	RBS	SERVICE STATION LOCK	F92	482	568	
H	—	HOTEL	F93	530	614	
DB	RDB	CLASSROOM INTRUDER	F110	572	659	
DO	—	DUMMY TRIM OUTSIDE	—	266	350	
DT	—	FULL DUMMY TRIM	—	380	466	
NB	—	COMMUNICATING PASSAGE	F111	404	488	
FB	RFB	COMMUNICATING STOREROOM	F112	475	550	
SB	RSB	COMMUNICATING CLASSROOM	F113	475	550	
FEL	RFEL	ELECTRICALLY LOCKED*	—	688	775	
FEU	RFEU	ELECTRICALLY UNLOCKED*	—	688	775	

Marks USA Antimicrobial Finish Available - Option Code: AM - Add \$40

LEVERS ARE PACKED 6 PER CASE

NOTE: Split designs and/or finishes are priced at the highest design and/or finish • Special finishes, consult factory

*ELECTRIFIED FUNCTIONS: 100% Duty Cycle 24V AC/DC, supplied with bridge rectifier : EU - 210 ma; EL - 125 ma

• IC Core Models: Tailpieces included, core not included

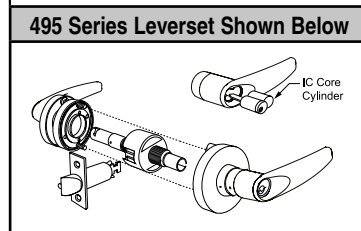
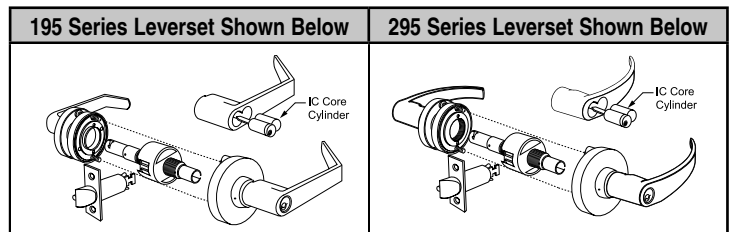

OPTIONS	CODE	PRICE - 195	295	495
For 2" doors	D1	NC	NC	NC
For 2-1/4" doors	D2	77	77	Call
Over 2-1/4" - 4" thickness	D9	667	667	667
2-3/8" backset, 1" x 2-1/4" face	E6	NC	NC	NC
5" backset, 9/16" throw, Gr. 1	E9	48	48	48
3-3/4" backset, 9/16" throw, Gr. 1	E10	48	48	48
Less cylinder	G3	Deduct 16	-16	-16
2-3/4" "T" strike	S3	NC	NC	NC
AMERICAN LEVER ONLY Accepts:				
Yale conventional cylinder	F7	24	24	—
Sargent conventional cylinder	F8	24	24	—
Corbin conventional cylinder	F9	24	24	—
Corbin 6 pin IC core	F12	35	35	—
Corbin 7 pin IC core	F13	35	—	—
Yale 6 pin IC core	F14	24	24	—
Yale 7 pin IC core	F15	24	—	—
Schlage 6 pin IC core	F19	24	24	—
Sargent IC core	F20	24	24	—
AMERICAN & CRESCENT LEVER ONLY Accepts:				
Medeco IC core large format	F21	24	24	—



★ **Standard & HI-SECURITY™ IC Core Models:** Interchangeable Core models for 6 or 7 pin cores (not included). **Accepts:** Marks, Marks HI-SECURITY™, Medeco®, KeyMark™, Falcon, Schlage® small format & Best®. **IC Core Tailpieces ARE Included.**



75 LINE GRADE 2 CYLINDRICAL SURVIVOR LEVERSETS

BHMA CERTIFIED			ANSI-A156.2 • Grade 2 Plus 3 Hour Fire Rating		SURVIVOR SERIES Series 175/175R, 275/275R, 475/475R • 2-3/4" Backset		
75 Series Leverset Shown Below					Standard Features		
					<ul style="list-style-type: none"> • Backset: 2-3/4" • Latch #1134, Front: 1-1/8" x 2-1/4"; Throw: 1/2"; Stainless steel nose • Levers: Solid cast Zamac; w/ 1/2" return (except 475) • Roses: Thru-bolted, 3-1/4" dia., spring loaded 2-#10 thru-bolts • Strike: #1145, ASA strike • Door thickness: 1-5/8" to 1-7/8"; <i>For 1-3/8" door use K1904 spacer</i> • Cylinder: MARKS "C" keyway, 6 pin w/ 2 keys 		
MARKS #		FUNCTION	ANSI #	175	275, 475	175, 275, 475	
COMM. CYL.	IC CORE CYL.*			26D	26D	3, 4, 10, 10B, 26	
N	—	PASSAGE	F75	200	217	238	
L	—	PRIVACY	F76	241	259	279	
P	—	PATIO	F77	215	233	253	
DC	RDC	COMMUNICATING	F80	285	303	323	
A	RA	ENTRY	F81	241	259	279	
B	RB	ENTRY	F82A	241	259	279	
AB	RAB	ENTRY	F109	241	259	279	
AQ	—	EXIT	F83	231	248	279	
S	RS	CLASSROOM	F84	241	259	279	
F	RF	STOREROOM	F86	241	259	279	
DW	RDW	INSTITUTION	F87	289	309	330	
DA	RDA	VESTIBULE	F88	291	309	330	
FQ	—	EXIT	F89	231	248	279	
T	RT	CORRIDOR	F90	252	270	290	
BS	RBS	SERVICE STATION LOCK	F92	252	270	290	
H	—	HOTEL	F93	305	322	343	
DO	—	DUMMY TRIM OUTSIDE	—	82	99	121	
DT	—	FULL DUMMY TRIM	—	167	184	205	
NB	—	COMMUNICATING PASSAGE	F111	175	190	205	
FB	RFB	COMMUNICATING STOREROOM	F112	253	262	273	
SB	RSB	COMMUNICATING CLASSROOM	F113	253	262	273	

OPTIONS	CODE	PRICE - 175	275	475
2-3/8" backset, 1" x 2-1/4" face	E6	NC	NC	NC
2-3/4" backset, 9/16" throw, Gr. 1, UL Listed	E7	48	48	48
5" backset, 9/16" throw, Gr. 1	E9	48	48	48
3-3/4" backset, 9/16" throw, Gr. 1	E10	48	48	48
Less cylinder	G3	Deduct 16	-16	-16
2-3/4" T strike	S3	NC	NC	NC
AMERICAN LEVER ONLY Accepts:				
Yale conventional cylinder	F7	24	24	—
Sargent conventional cylinder	F8	24	24	—
Corbin conventional cylinder	F9	24	24	—
Corbin 6 pin IC core	F12	35	35	—
Corbin 7 pin IC core	F13	35	—	—
Yale 6 pin IC core	F14	24	24	—
Yale 7 pin IC core	F15	24	24	—
Schlage 6 pin IC core	F19	24	24	—
Sargent IC core	F20	24	24	—
AMERICAN & CRESCENT LEVER ONLY Accepts:				
Medeco IC core large format	F21	24	24	—

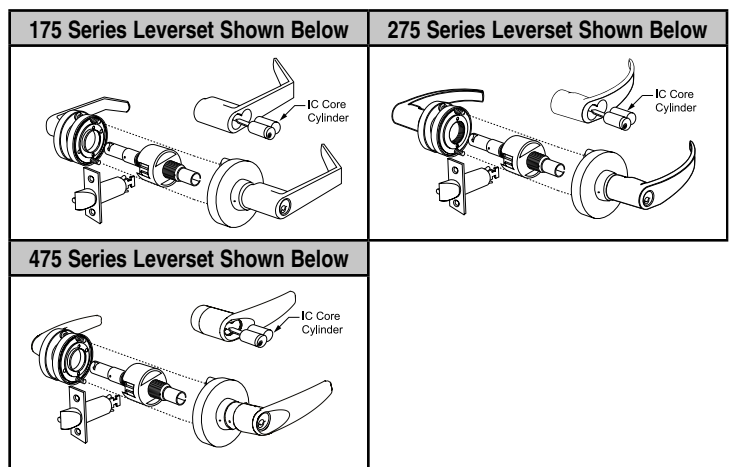

★ **Standard & HI-SECURITY™ IC Core Models:** Interchangeable Core models for 6 or 7 pin cores (not included). **Accepts:** Marks, Marks HI-SECURITY™, Medeco®, KeyMark™, Falcon, Schlage® small format & Best®. **IC Core Tailpieces ARE Included.**



CYLINDRICAL LOCK ACCESSORIES

Latches, Strikes, Etc.

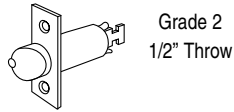

LATCH	THROW	Backset: 2-3/8" Front: 1" x 2-1/4"	Backset: 2-3/4" Front: 1-1/8" x 2-1/4"	FUNCTION	FINISH GROUPS		
					26D	3, 32D	10, 10B
GRADE 2	1/2"	1138A	1134A	ENTRANCE	—	45	55
		1138L	1134L	PRIVACY	—	33	45
		1138N	1134N	PASSAGE	—	33	45
		1138P	1134P	PATIO	—	45	55
GRADE 1	9/16"	—	1834A	ENTRANCE	—	92	100
		—	1834L	PRIVACY	—	77	92
		—	1834N	PASSAGE	—	77	92
		—	1834P	PATIO	—	77	92

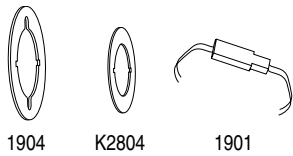
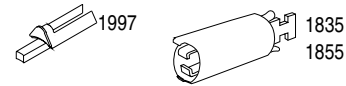
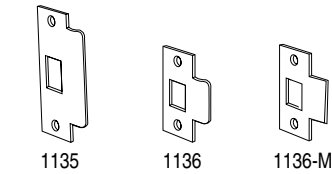

PART	#	DESCRIPTION	FINISH GROUPS	
			3, 32D	10, 10B
STRIKES	1135	4-7/8" ASA strike, curved lip	23	23
	P1136	2-3/4" "T" strike w/dust box, curved lip	14	22
	1136-M	2-3/4" "T" strike w/dust box, straight lip	15	23
SURVIVOR SERIES ALUMINUM SPACER RINGS	K1904	For 1-3/8" door (2 per set), 3-7/16" dia.	40	50
KNOB SPACER RINGS	K2804	For 1-3/8" door (2 per set), 2-3/4" dia.	40	51
PART	#	DESCRIPTION	NO FINISH	
EXTENSION LINK <i>For use with 2-3/4" Grade 1 backset latch</i>	1835	3-3/4"	33	
	1855	5"		
	1855-P	5" (Grade 1; L, P functions only)		
BRIDGE RECTIFIER	1901	Bridge rectifier 24 V AC/DC (no finish)	50	
CYLINDER RETAINER	1997	Lever handle cylinder retainer	6	
INSTALLATION TOOL	J295	175/195 installation drill jig	192	

CYLINDRICAL LOCK ACCESSORIES

Cylinders

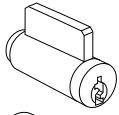

Conventional Cylinder

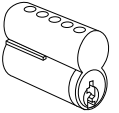

IC Core Cylinder
(Will Fit Best® Housings)

FOR KEYS & KEYING, SEE PAGE 76

PART #	DESCRIPTION	PRICE
1982	6 Pin, w/2 nickel-silver keys	35
R1182	6 Pin core, uncombined	44
*R1183	7 Pin core, uncombined	44
*RA1182	6 Pin core, combined	65
*RA1183	7 Pin core, combined	65
*RC1182	6 Pin core, construction core	46
*RC1187	Plastic core turnknob	8

Specify Tailpiece; Tailpiece Not Included.

IC core pricing includes KA, KD or MK Keying.

* Consult Factory on pricing of IC Cores when ordered with Locksets.

Cylindrical Lock Tailpieces

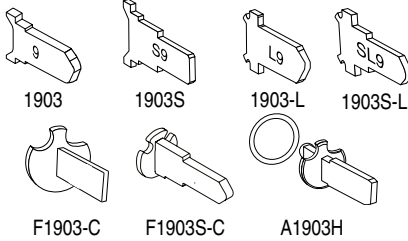

PART #	CODE	FUNCTION	CYLINDER	PRICE
1903	9	AB, B, DA (ext.), DW, F, FEL, FEU	MARKS 1982	7
1903S	S9	S, DA (int.), DB, DC, SB, T		
1903-L	L9	AB, B, DA (ext.), DW, F, FEL, FEU	Arrow PK 100C, Ilco 705, Lori 1539, Sargent 13-3266, Abloy, ASSA 65673, 65691	7
1903S-L	SL9	S, DA (int.), DB, DC, SB, T		
F1903-C	—	AB, B, DA (ext.), DW, F, FEL, FEU	Schlage 23-001, Primus, Corbin-Russwin 2000-034	7
F1903S-C	—	S, DA (int.), DB, DC, SB, T		

Cylindrical IC Core Tailpieces

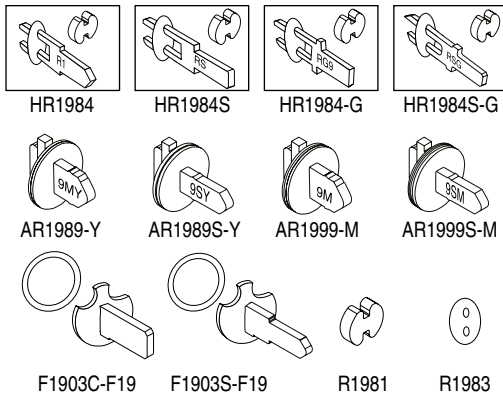

PART #	CODE	FUNCTION	CORE	PRICE
HR1984	R1	AB, B, DA (ext.), DW, F, FEU, FEL	6 or 7 pin Marks, KSP, Best®, Falcon, Medeco®, Keymark®, Sargent®, Schlage® Small Format	7
HR1984S	RS	S, DA (int.), DB, DC, SB, T		
HR1984-G	RG9	AB, B, DA (ext.), DW, F, FEU, FEL	6 or 7 pin Corbin	7
HR1984S-G	RSG	S, DA (int.), DB, DC, SB, T		
AR1989-Y	9MY	AB, B, DA (ext.), DW, F, FEU, FEL	6 or 7 pin Yale	9
AR1989S-Y	9SY	S, DA (int.), DB, DC, SB, T		
AR1999-M	9M	AB, B, DA (ext.), DW, F, FEU, FEL	Medeco®	9
AR1999S-M	9SM	S, DA (int.), DB, DC, SB, T	Medeco®	9
F1903C-F19	—	AB, DW, F	6 pin Schlage® Large Format	9
F1903S-F19	—	S, DA, DB, DC, SB, T		
R1981		Spacer		7
R1983		Security Disc		7

For Keying information see Pages 76-77

How To Order Example for Cylindrical Lock Cylinders & Tailpieces

1982	/	26D	—	9
1. Cylinder	Slash	2. Finish	Dash	3. Options

See list of cylinders available.

- | | | |
|------------------------------|------------------------------|----------------------------------|
| <input type="checkbox"/> 3 | <input type="checkbox"/> 26 | <input type="checkbox"/> Special |
| <input type="checkbox"/> 4 | <input type="checkbox"/> 26D | — |
| <input type="checkbox"/> 10 | <input type="checkbox"/> 32 | |
| <input type="checkbox"/> 10B | <input type="checkbox"/> 32D | |

Tailpiece & keying information must be included in the option section.

CYLINDRICAL KNOB/LEVER FUNCTIONS

ANSI# CODE	MARKS FUNCTION
F75	.N
F76	.L
F76 (MOD.)	.LK
F77	.P
F80	.DC
F81	.A

ANSI# CODE	MARKS FUNCTION
F82A	.B
F83	.AQ
F84	.S
F86	.F
F87	.DW
F88	.DA

ANSI# CODE	MARKS FUNCTION
F89	.FQ
F90	.T
F90 (MOD.)	.TK
F91 (95 Series Leverset ONLY)	.GB
F92	.BS
F93	.H

ANSI# CODE	MARKS FUNCTION
F109	.AB
F110	.DB
F111	.NB
F112	.FB
F113	.SB

ANSI # CODE	Marks Function	
	I/S	O/S
F75 PASSAGE: Latch by knob/lever either side.		N
F76 PRIVACY: Latch by knob/lever either side unless outside knob/lever locked by push-button from inside. Outside unlocks by turning inside knob/lever, outside emergency turn or closing door.		L
F76 (MOD.) HOSPITAL/PRIVACY: Latch by knob/lever either side unless outside knob/lever locked by push-button from inside. Outside unlocks by turning inside knob/lever, outside turn or closing door. Emergency turn-knob A5 option.		LK
F77 PATIO: Deadlocking latch by knob/lever either side unless outside knob/lever locked by push-button inside. Unlocks by turning inside knob/lever or closing door.		P
F80 COMMUNICATING: Key both sides. Locks or unlocks either knob/lever independent of the other. Deadlocking latch.		DC
F81 ENTRY: Deadlocking latch bolt by knob/lever either side except when outside locked by turn-button inside. When outside locked, key outside or knob/lever inside opens lock. Turn-button operated manually.		A
F82A ENTRY: Deadlocking latch by knob/lever either side. Outside locked by push-button inside. When outside locked by push-button inside, key opens lock, unlocks push-button. Inside knob/lever always opens latch. Closing door does not release push-button.		B
F83 EXIT: Deadlocking latch by knob/lever either side except when outside locked by turn-button inside. Inside knob/lever always opens latch. Turn-button operated manually.		AQ
F84 CLASSROOM: Deadlocking latch by knob/lever inside. Outside knob/lever locked or unlocked by key.		S
F86 STOREROOM: Deadlocking latch by knob/lever inside, key outside. Outside knob/lever always locked.		F
F87 INSTITUTION: Both knob/levers always locked. Deadlocking latch by key both sides.		DW
F88 VESTIBULE: Deadlocking latch by knob/lever either side, except when outside knob/lever locked by key inside. Key outside retracts deadlocking latch. Inside always open.		DA
F89 EXIT: Deadlocking latch by knob/lever inside. Outside always locked.		FQ
F90 CORRIDOR: Deadlocking latch by knob/lever either side unless outside locked by key or inside push-button. Unlock by key, turning inside knob/lever or closing door.		T

ANSI # CODE	Marks Function	
	I/S	O/S
F90 (MOD.) HOSPITAL/PRIVACY: Deadlocking latch by knob/lever either side unless outside locked by knob/lever or inside push-button. Unlock by turn-knob, turning inside knob/lever or closing door. Emergency turn-knob A5 option.		TK
F91 STORE DOOR (95 Series Leverset ONLY): Deadlocking latch by knob/lever either side except when both knob/levers are locked by key from either side.		GB
F92 SERVICE STATION LOCK: Deadlocking latch by knob/lever either side unless outside locked by key or inside push-button. Unlock by key, turning inside knob/lever or closing door, except when slotted push-button is turned in locked position. Inside knob/lever always opens latch.		BS
F93 HOTEL: Deadlocking latch by knob/lever inside. Outside knob/lever always locked. Inside push-button projects indicator on cylinder face shutting out all keys except emergency key. Turning inside knob/lever or closing door releases push-button.		H
F109 ENTRY: Outside locked by pushing turn-button inside. Key outside opens lock. Rotating inside knob/lever releases button and outside knob/lever. By pushing and turning inside button, outside knob/lever remains locked. Deadlocking latch.		AB
F110 CLASSROOM INTRUDER: Deadlocking latch by knob/lever either side, except when outside locked by key inside. Key outside locks or unlocks outside. Inside always open		DB
DUMMY TRIM: Outside only, rigid.		DO
DUMMY TRIM: Both sides, rigid.		DT
F111 COMMUNICATING PASSAGE: Blank outside. Deadlocking latch by knob/lever inside.		NB
F112 COMMUNICATING STOREROOM: Blank outside. Deadlocking latch by key only. Knob/lever always locked.		FB
F113 COMMUNICATING CLASSROOM: Blank outside. Inside knob/lever locked or unlocked by key. Deadlocking latch.		SB
ELECTRICALLY LOCKED - FEL (Fail Safe): Outside always locked electrically. Open by key outside, switch or loss of power. Deadlocking latch by lever inside. Lever only.		FEL
ELECTRICALLY UNLOCKED - FEU (Fail Secure): Outside always locked until unlocked by key or electrically energized. Deadlocking latch by lever inside. Lever only.		FEU

Cylindrical Locksets

How To Order Tubular Locksets

How To Order Example for Tubular Locksets

1	RW	92	N	/	32D	—	S3
<i>1. Lockset Series</i>	<i>2. Rose Design</i>	<i>3. Knob/Lever</i>	<i>4. Marks Function</i>	<i>Slash</i>	<i>5. Finish</i>	<i>Dash</i>	<i>6. Options</i>

1 SERIES	
Tubular Locksets	1
Cylindrical Cartridge	1

2 ROSES		
ROSES		DESIGN
9602-R	Rose with ring 2-9/16" dia.	RR
9602	Plain rose 2-9/16" dia.	RW
5602-R	Small rose with ring 2-1/4" dia.	RQ
5602	Small rose 2-1/4" dia.	RS
7602	Square rose 2-9/16" square	RX
7607	Square forged rose 2-9/16" square	RK

3 KNOB/LEVER		
KNOBS		DESIGN
1153	Round, wrought	10
1253	Ball, wrought	20
9631	Ball, forged	30
9609	Eclipse, forged	60
LEVERS		DESIGN
SF031	Copa	031
5642	Palace	42
5657	Monaco	57
5662	Royale	62
5672	Towne	72
5677	Maxwell	77
5678	Omni	78
5682	Plaza	82
5683	Dayton	83
5686	Crescent	86
5692	American	92
5696	Titan	96

4 TUBULAR FUNCTIONS		
MARKS #		ANSI #
TUBULAR LOCKSETS		
N	PASSAGE	F75
L	PRIVACY	F76
NB	COMMUNICATING	F111
DI	DUMMY TRIM INSIDE	
DO	DUMMY TRIM OUTSIDE	
DT	FULL DUMMY	

5 FINISH		
MARKS		ANSI #
US 3	Polished Brass, Clear Coated	605
US 3E	Polished Brass "PVD"	605E
US 4	Satin Brass, Clear Coated	606, 606E
US10	Satin Bronze, Clear Coated	612E
US 10B	Dark Bronze, Clear Coated	613E
US15	Satin Nickel	619, 619E
US 26	Polished Chrome, Plated	625
US 26D	Satin Chrome, Plated	626
US 32	Polished Stainless Steel	629
US 32D	Satin Stainless Steel	630

6 OPTIONS		
TRIM MODIFICATIONS	CODE	PRICE
Tactile knob/lever, coated ext. only	A1	62
Tactile knob/lever, knurled	A4	62
Tactile knob/lever, coated int. & ext.	A18	126
DOOR THICKNESS	CODE	PRICE
1-3/4"	D4	NC
1-3/8"	D5	NC
LATCH	CODE	PRICE
2-3/4" backset, 1-1/8" x 2-1/4" face	E4	11
2-3/4" backset, 9/16" throw, Gr. 1, UL Listed With Cylindrical Cartridge*		
2-3/8" backset, 1-1/8" x 2-1/4" face	E7	110
2-3/4" backset, 1-1/8" x 2-1/4" face	E11	14
2-3/4" backset, 1 x 2-1/4" face	E12	14
Adjustable latch 1-1/8" x 2-1/4" face	E13	11
TRIM CHANGES	CODE	PRICE
For 1-1/2" bore	F6	18
STRIKE	CODE	PRICE
4-7/8" ASA strike	S1	14
2-3/4" "T" strike	S3	NC
3-5/8" Security strike	S4	12
2-1/4" Curved lip strike	S5	NC

* E7 Option Available: 2-3/8", 2-3/4", 3-3/4" & 5" Backset, for N Function ONLY.

TUBULAR KNOB/LEVER FUNCTIONS









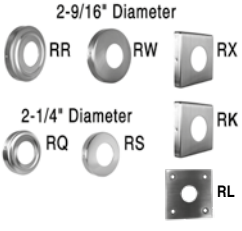

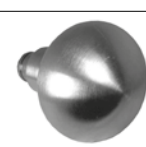











ANSI # CODE	MARKS FUNCTION						
F75 PASSAGE: Latch by knob/lever either side.	<table border="1"> <tr> <td>I/S</td> <td>O/S</td> <td></td> </tr> <tr> <td></td> <td></td> <td>N</td> </tr> </table>	I/S	O/S				N
I/S	O/S						
		N					
F76 PRIVACY: Latch by knob/lever either side unless outside knob/lever locked by push-button from inside. Outside unlocks by turning inside knob/lever, outside emergency turn or closing door.	<table border="1"> <tr> <td>I/S</td> <td>O/S</td> <td></td> </tr> <tr> <td></td> <td></td> <td>L</td> </tr> </table>	I/S	O/S				L
I/S	O/S						
		L					
F111 COMMUNICATING: Blank outside. Deadlocking latch by knob/lever inside.	<table border="1"> <tr> <td>I/S</td> <td>O/S</td> <td></td> </tr> <tr> <td></td> <td></td> <td>NB</td> </tr> </table>	I/S	O/S				NB
I/S	O/S						
		NB					

ANSI # CODE	MARKS FUNCTION						
DUMMY TRIM INSIDE: Dummy trim inside ONLY.	<table border="1"> <tr> <td>I/S</td> <td>O/S</td> <td></td> </tr> <tr> <td></td> <td></td> <td>DI</td> </tr> </table>	I/S	O/S				DI
I/S	O/S						
		DI					
DUMMY TRIM OUTSIDE: Dummy trim outside ONLY.	<table border="1"> <tr> <td>I/S</td> <td>O/S</td> <td></td> </tr> <tr> <td></td> <td></td> <td>DO</td> </tr> </table>	I/S	O/S				DO
I/S	O/S						
		DO					
FULL DUMMY TRIM: Dummy trim both sides.	<table border="1"> <tr> <td>I/S</td> <td>O/S</td> <td></td> </tr> <tr> <td></td> <td></td> <td>DT</td> </tr> </table>	I/S	O/S				DT
I/S	O/S						
		DT					

ROSE DESIGN RR, RW, RQ, RS, RX*, RK*, RL*

Tubular Locksets

ANSI-A156 • Grade 2			Series 1 • 2-3/8" Backset					
Standard Features			KNOBS			LEVERS		
 <p>2-9/16" Diameter RR RW RK 2-1/4" Diameter RQ RS RK RL</p>	<ul style="list-style-type: none"> • Backset: 2-3/8", 2-3/4" optional • Front: 1" x 2-1/4" • Thru-bolted screwless knob/lever rose • Concealed mounting screws • Lever support springs • Independent spring loaded captivated spindles • Strike: 2-1/4" full curved lip • Latch support housing • Door thickness: 1-3/8" to 1-3/4" • Privacy function - interior with automatic release 		10, 20	30, 60		031, 44, 55, 57, 72, 77, 78, 82, 83, 86, 92, 96		82, 83, 86, 92, 96, 031
	FINISH GROUPS							
MARKS #	FUNCTION	ANSI #	3, 32D	3E, 15	10B, 26	3E, 4, 15, 26D	10E, 10B, 19E 14, 26	32, 32D
KEYLESS								
N	PASSAGE	F75	242	309	347	325	364	313
L	PRIVACY	F76	253	320	359	336	375	324
NB	COMMUNICATING	F111	297	397	336	314	352	303
DUMMY TRIM								
DI	DUMMY TRIM INSIDE		113	146	218	156	174	148
DO	DUMMY TRIM OUTSIDE							
DT	FULLY DUMMY		226	293	331	309	347	297
NOTE: Split designs and/or finishes are priced at the highest design and/or finish • Special finishes, consult factory								
*Square Rose RX: Add \$30 / *Square Rose RZ: Add \$70 / *Square Rose RK: Add \$100								

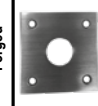
KNOBS	Round Knob 10	Ball Knob 20	Ball Knob 30	Eclipse Knob 60	ROSES	RR: 2-9/16" dia.
						
LEVERS	Stanhope Lever 44	Copa Lever 031	Brompton Lever 55	Monaco Lever 57 Specify handing		RW: 2-9/16" dia.
						RQ: 2-1/4" dia.
	Towne Lever 72	Maxwell Lever 77	Omni Lever 78	Plaza Lever 82 Specify handing		RS: 2-1/4" dia.
						RX: 2-1/2" sq.
	Dayton Lever 83 Specify handing	Crescent Lever 86	American Lever 92	Titan Lever 96		RK: 2-1/2" sq.
					RL: 1-1/2" sq.	

OPTIONS	CODE	PRICE	NOTE
1-3/8" door thickness	D5	NC	
2-3/4" backset, 1-1/8" x 2-1/4" face	E4	11	
2-3/4" backset, 9/16" throw, Gr. 1, UL Listed WITH CYLINDRICAL CARTRIDGE *	E7	110	N Function Only
2-3/8" backset, 1-1/8" x 2-1/4" face	E11	14	
2-3/4" backset, 1" x 2-1/4" face	E12	14	
4-7/8" ASA strike	S1	14	
2-3/4" "T" strike	S3	NC	
US 26 Interior	x26	25	83, 92, 96 Only

* E7 Option Available: 2-3/8", 2-3/4", 3-3/4" & 5" Backset, for N Function ONLY.

INTERIOR TUBULAR LOCKSETS

Tubular Locksets



NEW! 60 Series, Stainless Steel, Commercial Locksets

Standard Features

- Latch Face: 1" x 2-1/4" standard
- Backset: 2-3/4" with 2-3/4" T-strike with square corners
- Door thickness: 1-3/8" to 1-3/4"
- Roses: 2-9/16" diameter
- Backset: 2-3/8" with 2-1/4", radius corner full lip strike, option E6, N/C
- Privacy Function with kick-off latch

MARKS #	FUNCTION	ANSI #	FINISH GROUPS (160, 260 & 360)	
				32D
N	PASSAGE	F75		144
L	PRIVACY	F76		155
DO	DUMMY TRIM OUTSIDE	—		72

LEVERS ARE PACKED 9 PER CASE Additional finishes, consult factory

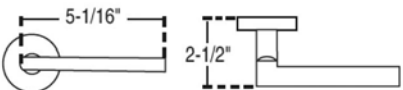
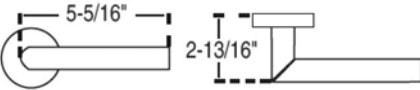
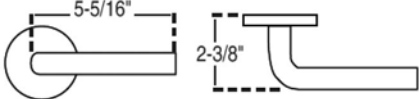
160 Series Finishes: 32D	260 Series Finishes: 32D	360 Series Finishes: 32D
		
		

50 Series, Residential Leversets

Standard Features

- Pressure cast Levers
- Roses: 2-15/16" diameter
- Adjustable Backset: 2-3/8" - 2-3/4"
- Latch: 1" x 2-1/4" front, 1/2" throw
- Door thickness: 1-3/8" to 1-3/4"
- Privacy Function with kick-off latch
- Strike: 2-1/4" full lip strike
- NOTE: Latches & strikes have radius corners**

MARKS #	FUNCTION	ANSI #	FINISH GROUPS (150, 250 & 450)	
				26D
N	PASSAGE	F75		68
L	PRIVACY	F76		80
DO	DUMMY TRIM OUTSIDE	—		35

LEVERS ARE PACKED 24 PER CASE Additional finishes, consult factory

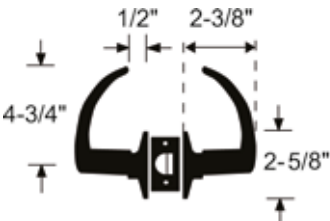
150 Series American Lever Finishes: 26D	250 Series Crescent Lever Finishes: 26D	450 Series Titan Lever Finishes: 26D
		
		

TUBULAR LOCKSET ACCESSORIES

Strikes, Latches, Support Housing

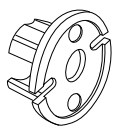

1631



1536

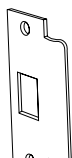

1145

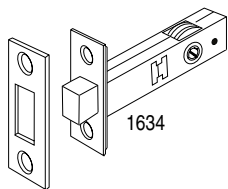

1634

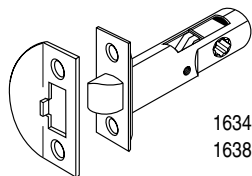

1636

1634N
1638N

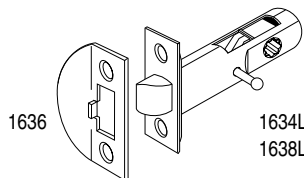

1636

1634L
1638L

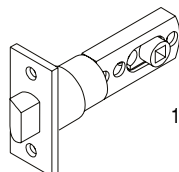

1648N

PART #	DESCRIPTION	BACKSET FRONT	FINISH GROUPS		
			NO FINISH	3, 26	10, 10B, 32
1631	Support housing	—	10	—	—
1536	"T" Strike, 2-3/4" curved lip	—	—	10	16
1145	4-7/8" ASA strike	—	—	12	22
1634	Tubular deadbolt	2-3/4"	—	107	114
1636	Strike, 2-1/4" full curved lip	—	—	10	16
1634N	Passage latch w/ strike	2-3/4"	—	76	97
1634L	Privacy latch w/ strike	1" x 2-1/4"	—	91	101
1638N	Passage latch w/ strike	2-3/8"	—	49	62
1638L	Privacy latch w/ strike	1" x 2-1/4"	—	62	74
1648N	UL Listed Adjustable Backset Latch RESIDENTIAL INTERIOR LOCKSETS ONLY	2-3/8" - 2-3/4"	—	—	98

Turnpieces



SKA03



SKA015



1351



8101P



5108



A7616

PART #	DESCRIPTION	FINISH GROUPS					
		3E	3	26D	4	10, 10B, 26	32D
SKA03	Turnpiece	—	—	—	—	—	85
SKA015	Turnpiece	73	56	56	73	65	—
1351	Turnpiece	—	—	75	—	—	—
8101P	Turnpiece	62	44	44	62	53	53
5108	Turnpiece	—	—	75	—	—	—
A7616	Turnpiece	73	56	56	73	65	65

Latches & Cylindrical Cartridge

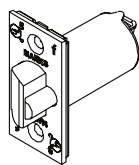

1834

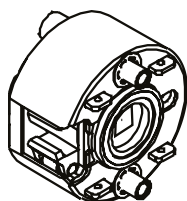

A1430

Cylindrical Cartridge
NOTE: Cylindrical Cartridge is for use with E7* Option ONLY.

LATCH	THROW	Backset 2-3/8"; Front 1" x 2-1/4"	Backset 2-3/4"; Front 1-1/8" x 2-1/4"	FUNCTION	FINISH GROUPS	
					3, 32D	10, 10B
GRADE 2	1/2"	1138A	1134A	ENTRANCE	44	55
GRADE 1	9/16"	—	1834A	ENTRANCE	92	99

PART #	DESCRIPTION	NO FINISH
A1430	Cylindrical Cartridge	110

How To Order DEFENDER LOCKSETS

How To Order Example for Defender Locksets					
145	K	/	32D	—	D1
<small>1. Lockset Series</small>	<small>2. Marks Function</small>	<small>Slash</small>	<small>3. Finish</small>	<small>Dash</small>	<small>4. Options Specify: Keying, Handing & Door Thickness</small>

1 SERIES	
Defender Tubular Deadbolt Locksets	130, 130R
Defender Cylindrical Cartridge Deadlatch Locksets	145, 145R

2 TUBULAR FUNCTIONS			
DEADBOLT/DEADLATCHES (* indicates IC Core)			
		130 Series	145 Series
K	RK*	CYLINDER x TURNPIECE	E0151 E01101
KK	RKK*	CYLINDER x KNOB	
L	RL*	COMM. SINGLE CYLINDER	E0161 E0131
KL	RKL*	CYLINDER x LEVER	E01101
M	RM*	DOUBLE CYLINDER	E0141 E01111
S	RS*	CLASSROOM	E0171
X		TURNPIECE	E0191 E01121

3 FINISH		
MARKS		ANSI #
US 3	Polished Brass, Clear Coated	605
US10	Satin Bronze, Clear Coated	612E
US 10B	Dark Bronze, Clear Coated	613E
US 26D	Satin Chrome, Plated	626
US 32	Polished Stainless Steel	629
US 32D	Satin Stainless Steel	630



4 OPTIONS		
TRIM MODIFICATIONS	CODE	PRICE
Tactile knob/lever, coated ext. only	A1	62
Tactile knob/lever, knurled	A4	62
Tactile knob/lever, coated int. & ext.	A18	126
DOOR THICKNESS	CODE	PRICE
50 mm (2")	D1	NC
57 mm (2-1/4")	D2	53
1-1/4" - 1-1/2"	D8	NC
LATCH	CODE	PRICE
2-3/4" backset, 1-1/8" x 2-1/4" face	E4	11
2-3/8" backset, 1-1/8" x 2-1/4" face	E11	13
TRIM CHANGES	CODE	PRICE
Sargent conventional cylinder	F8	23
CYLINDER	CODE	PRICE
Less cylinder	G3	Deduct 16
STRIKE	CODE	PRICE
4-7/8" ASA strike	S1	14
4-7/8" x 1-1/4" security strike	S4	12



Defender Series

DEADBOLT/DEADLATCH FUNCTIONS

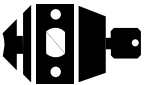
ANSI # CODE	MARKS # FUNCTION
130 SERIES:	
E0151	K
E0161	L
E0141	M
E0171	S
E0191	X

ANSI # CODE	MARKS # FUNCTION
145 SERIES:	
E01101	K
E0131	L
E01101	KL
E01111	M
E01121	X

ANSI # CODE	Marks Function	
	I/S	O/S
CYLINDER x TURNPIECE: Deadbolt/deadlatch by inside turnpiece or outside key.		K
COMMUNICATING SINGLE CYLINDER: Deadbolt/deadlatch by key from one side only.		L
CYLINDER x LEVER: Deadlatch by key outside. Inside lever always opens latch.		KL

ANSI # CODE	Marks Function	
	I/S	O/S
DOUBLE CYLINDER: Deadbolt/deadlatch by key either side.		M
CLASSROOM: Deadbolt by outside key. Turnpiece will retract but not project deadbolt.		S
TURNPIECE x BLANK PLATE: Deadbolt/deadlatch by inside turnpiece. Blank plate outside.		X

130 SERIES "DEFENDER" TUBULAR DEADBOLTS

ANSI 156.5				Standard Features	
 130K				<ul style="list-style-type: none"> Bolt: 1" throw Unitized assemblies for 2-1/8" bore Strike: #1335, 2-3/4" x 1-1/8" strike Door thickness: 1-3/8" to 1-7/8" Cylinder: MARKS "C" keyway, 6 pin w/ 2 keys 2-3/8" Backset Latch front: 1" x 2-1/4" 	
MARKS #		FUNCTION	ANSI #	FINISH GROUPS	
COMM. CYL.	IC CORE CYL.*			3, 10, 10B, 32, 32D	
K	RK	CYLINDER x TURNPIECE	E0151	210	
L	RL	COMMUNICATING SINGLE CYL	E0161	210	
M	RM	DOUBLE CYLINDER	E0141	203	
S	RS	CLASSROOM	E0171	183	
X	—	TURNPIECE x BLANK PLATE	E0191	147	

DEADBOLTS ARE PACKED 24 PER CASE

NOTE: Split designs and/or finishes are priced at the highest design and/or finish • Special finishes, consult factory
• IC Core Models: Core not included

OPTIONS	CODE	PRICE
For 2" door	D1	NC
For 2-1/4" door	D2	53
For 1-1/4" - 1-1/2" door	D8	NC
2-3/4" backset, 1-1/8" x 2-1/4" face	E4	12
For 1-1/2" bore	F6	21
Sargent original cylinder or core	F8	23
Less cylinder	G3	Deduct 15
3-5/8" x 1-1/4" Security strike	S4	12

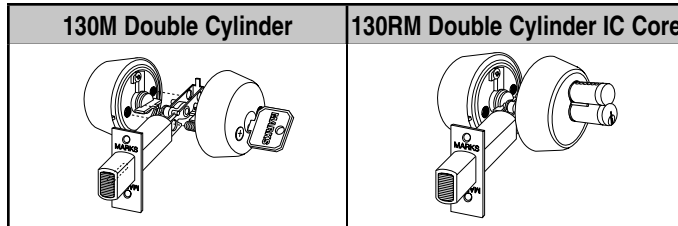

*** Standard IC Core Models:** 

Interchangeable Core models for 6 or 7 pin cores (not included).
Accepts: Marks, Medeco KeyMark™, Falcon & Best®. IC Core Tailpieces ARE Included.

145 SERIES "DEFENDER" CYLINDRICAL CARTRIDGE DEADLATCHES

BHMA CERTIFIED		ANSI 156.5 • 3 Hour Fire Rating	UL LISTED	Standard Features	
 145M				<ul style="list-style-type: none"> Series 1 Cylindrical Cartridge Latch: Grade 1, 9/16" throw, 2-3/4" backset Unitized assemblies for 2-1/8" bore Strike: #1136, 2-3/4" strike Door thickness: 1-3/4"; For 1-3/8" doors use spacer rings K1442/32D Cylinder: MARKS "C" keyway, 6 pin w/ 2 keys Latch front: 1-1/8" x 2-1/4" 	
MARKS #		FUNCTION	ANSI #	FINISH GROUPS	
COMM. CYL.	IC CORE CYL.*			3, 10, 10B, 32, 32D	
K	RK	CYLINDER x TURNPIECE	E01101	227	
L	RL	COMMUNICATING SINGLE CYL	E0131	227	
M	RM	DOUBLE CYLINDER	E01111	246	
X	—	TURNPIECE x BLANK PLATE	E01121	193	
KL	RKL	CYLINDER x LEVER	E01101	384	
KK	RKK	CYLINDER x KNOB		399	

DEADLATCHES ARE PACKED 24 PER CASE

NOTE: Split designs and/or finishes are priced at the highest design and/or finish • Special finishes, consult factory
• IC Core Models: Core not included

OPTIONS	CODE	PRICE
For 2" door	D1	NC
For 2-1/4" door	D2	55
2-3/8" backset, 1-1/8" x 2-1/4" face	E11	14
Sargent original cylinder or core	F8	23
Less cylinder	G3	Deduct 15
4-7/8" ASA strike	S1	14

*** Standard IC Core Models:** 

Interchangeable Core models for 6 or 7 pin cores (not included).
Accepts: Marks, Medeco KeyMark™, Falcon & Best®. IC Core Tailpieces ARE Included.

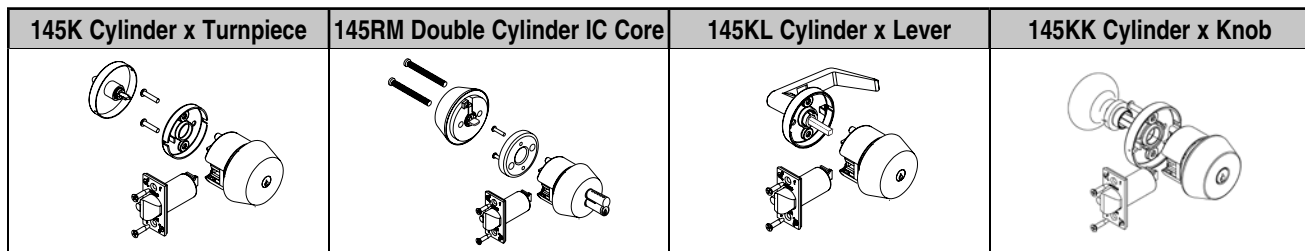

DEFENDER SERIES ACCESSORIES

Strikes, Latches & Spacers

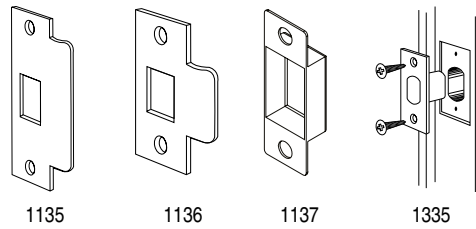

1135 1136 1137 1335

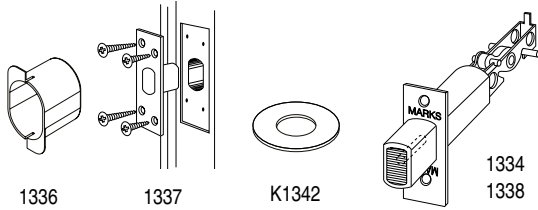

1336 1337 K1342 1334 1338

PART #	DESCRIPTION	FINISH GROUPS		
		NO FINISH	3, 32D	10, 10B, 32
1135	4-7/8" ASA STRIKE	—	23	23
1136	2-3/4" "T" STRIKE W/DUST BOX	—	10	15
1137	DUST BOX, PLASTIC, LATCH	6	—	—
1335	2-3/4" x 1-1/8" STANDARD STRIKE	—	8	10
1336	DUST BOX, PLASTIC, DEADBOLT	6	—	—
1337	3-5/8" x 1-1/4" HIGH SECURITY STEEL STRIKE, PLATED FINISH	—	68	—
K1342	1-3/8" DOOR, ROSE EXTENDERS, 130 Series	—	54	67
DEADBOLTS				
1334	2-3/4" BACKSET FRONT 1-1/8" x 2-1/4"	—	35	44
1338	2-3/8" BACKSET FRONT 1-1/8" x 2-1/4"	—	35	44
K1442	1-3/8" DOOR, 145 SERIES	—	155	—

Latches & Cylindrical Cartridge

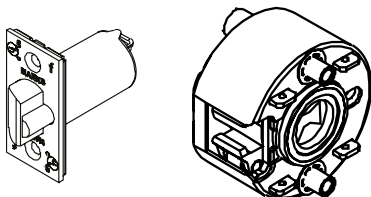

1834

A1420 Cylindrical Cartridge for use with 145 Series

NOTE: Cylindrical Cartridge is for use with E7* Option ONLY.

LATCH	THROW	Backset 2-3/8" Front 1" x 2-1/4"	Backset 2-3/4" Front 1-1/8" x 2-1/4"	FUNCTION	FINISH GROUPS	
					3, 32D	10, 10B
GRADE 2	1/2"	1138A	1134A	ENTRANCE	44	55
GRADE 1	9/16"	—	1834A	ENTRANCE	92	99

PART #	DESCRIPTION	NO FINISH
A1420	Cylindrical Cartridge for use with 145 Series	110

Tailpieces & Cylinders

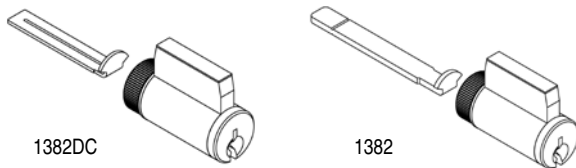

1382DC 1382

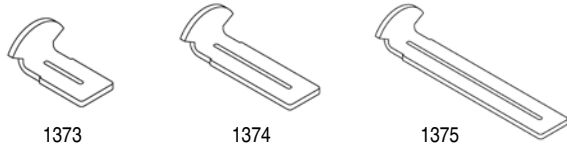

1373 1374 1375

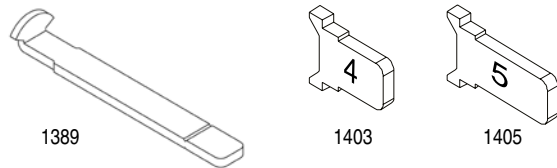

1389 1403 1405

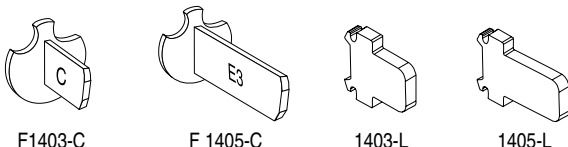







F1403-C F1405-C 1403-L 1405-L

PART #	TAILPIECES FOR 130 DEADBOLTS	PRICE
DOUBLE CYLINDER		
1373	1-5/16" to 1-3/8"	MARKS 1382DC
1374	1-5/8" to 2"	
1375	2-1/8" to 2-3/8"	
SINGLE CYLINDER		
1389	1-3/4" to 2-1/4"	MARKS 1382
TAILPIECES FOR 145 DEADLATCHES		
1403	1-5/8" to 1-7/8"	MARKS TAILPIECE
1405	2" to 2-1/4"	
F1403-C	1-5/8" to 1-7/8"	SCHLAGE® TAILPIECE
F1405-C	2" to 2-1/4"	
1403-L	1-5/8" to 1-7/8"	LORI / ILCO TAILPIECES
1405-L	2" to 2-1/4"	

I-QWIK LITE² SERIES



NO-NONSENSE ACCESS CONTROL RIGHT OUT OF THE BOX

MARKS #		LOCKSET TYPE - PACKED PER CASE	# OF USERS	FINISH GROUPS	
IQ1LITE	IQ1L/26D			19 Black Powder Coat; with 26D American Levers	26D Satin Chrome
		IQ1: Cylindrical Lockset - <i>PACKED 4 PER CASE</i>	160	568	654
		IQ2: Mortise Lockset - <i>PACKED 4 PER CASE</i>	160	917	1003
		IQ7: Rim Exit Device Interface - <i>PACKED 6 PER CASE</i> <i>Adapter plates operate most manufacturers Rim Exit Devices.</i> <i>Adapter plates for Mounting Exit Devices are sold separately, see page 70.</i>	160	797	884

Access Control

Standard Features		
<ul style="list-style-type: none"> • CableGuard™ protects wires for easy installation • Standard ANSI door prep with one additional hole • Pre-programmed code • Keypad programmable • 160 User codes • Temporary user codes 	<ul style="list-style-type: none"> • Passage mode • Pin only mode • Double code entry for maximum security • Two wire remote release • 16 Digit tactile metal keypad • Weatherproof standard 	<ul style="list-style-type: none"> • Audible & visible entry indicator • Audible low battery alert • 4 "AA" batteries, 95,000 operations • Easy installation • Lifetime Mechanical Warranty; 2 Year Electronic Warranty

IQ1 LITE Cylindrical Lockset Specifications

Door Thickness: 1-3/4" standard;
For thicker doors, Consult factory

Handing: Non-handed

Key Override: Marks "C" keyway, 6 pin w/2 keys, IC Core optional

Lock Body: Cylindrical "Survivor" featuring the "Clutch" for trouble free service

Latch: Grade 2, 2-3/4" backset, 1/2" throw, 3 Hour UL fire rating

Strike Plate: 4-7/8" ASA strike

IQ2 LITE Mortise Lockset Specifications

Door Thickness: 1-3/4" standard;
For thicker doors, Consult factory

Handing: Field reversible

Key Override: 1-1/8" Mortise cylinder, 6 pin w/2 keys

Lock Body: Grade 1, Series 5, 2-3/4" backset, 3/4" anti-friction latch, 3 Hr UL fire rating

Auxiliary Latch: 1/2" throw

Clutch: The "Clutch" for trouble free service

Strike Plate: 4-7/8" ASA standard

IQ7 LITE Rim Exit Device Interface Specifications

Door Thickness: 1-3/4" standard;
For thicker doors, Consult factory

Handing: Non-handed

Key Override: 1-1/8" Mortise cylinder, 6 pin w/2 keys

Clutch: The "Clutch" for trouble free service

Adapter plates operate most manufacturers Rim Exit Devices. Adapter plates for Mounting Exit Devices are sold separately, see page 70.

How To Order Example for i-Qwik LITE Series Electronic Access Control Locksets

IQ	1LITE	
1. Lockset Series	2. Model Number	26D Finish

IQ

1LITE (Cylindrical)

1L/26D (Cylindrical)

2LITE (Mortise)

2L/26D (Mortise)

7LITE (Rim Exit Device Interface)

7L/26D (Rim Exit Device Interface)

I-QWIK/I-QUE SERIES

OPTIONS



I-QWIK / I-QUE OPTIONS			Cylindrical			Mortise			Rim Exit Device Interface		
DESCRIPTION	CODE	PRICE	IQLITE	IQDATA	IQPROX	IQLITE	IQDATA	IQPROX	IQLITE	IQDATA	IQPROX
Backset											
2-3/8" Backset	E6	NC	•	•	•						
5" Backset	E9	48	•	•	•						
3-3/4" Backset	E10	48	•	•	•						
Series 55 Mortise Lock Body (2-1/2" bkst)	W8	NC				•	•	•			
Levers											
Tactile Lever	A1	62	•	•	•	•	•	•	•	•	•
Lever to accept Sargent conventional cyl.	F8	24	•	•	•						
Lever to accept Corbin conventional cyl.	F9	24	•	•	•						
Lever to accept Corbin IC Core 6 pin	F12	35	•	•	•						
Lever to accept Corbin IC Core 7 pin	F13	35	•	•	•						
Lever to accept Yale IC Core 6 pin	F14	24	•	•	•						
Lever to accept Yale IC Core 7 pin	F15	24	•	•	•						
Lever to accept Schlage IC Core 6 pin	F19	24	•	•	•						
Lever to accept Sargent IC Core	F20	23	•	•	•						
Lever to accept Medeco IC Core lg. format	F21	24	•	•	•						
Monaco Lever	W3	21	•	•	•	•	•	•	•	•	•
Solid Exterior Handle (no cylinder)	W4	NC	•	•	•	Std	Std	Std	Std	Std	Std
Crescent Lever	W7	21	•			•	Std	Std	•	Std	Std
Titan Lever	W12	21	•	•	•	•	•	•	•	•	•
Cylinder											
IC Core Cylinder Housing	G1	NC	•	•	•	•	•	•	•	•	•
Less Cylinder	G3	Deduct 16	•	•	•	•	•	•	•	•	•
Strike											
4-7/8" ASA Strike	S1	14	•	Std	Std	Std	Std	Std			
2-3/4" "T" Strike	S3	NC	Std	•	•						
Miscellaneous											
Tamper-proof Screws	A3	15	•	•	•	•	•	•	•	•	•
Lead Lined IQ	F22	526	•	•	•	•	•	•	•	•	•







Access Control



I-QWIK/I-QUE SERIES ACCESSORIES, TAILPIECES & CAMS

I-QWIK / I-QUE ACCESSORIES			Cylindrical			Mortise			Rim Exit Device Interface		
ACCESSORY	PART #	PRICE	QDLITE	QDATA	QPROX	QDLITE	QDATA	QPROX	QDLITE	QDATA	QPROX
Bridge rectifier (converts AC power to DC power)	1901	42	•	•	•	•	•	•	•	•	•
Gasket (interior inside housing for full weatherproofing)	E1108	8	•	•	•	•	•	•			
Battery Pack Holder	EA4011	21	•	•	•	•	•	•	•	•	•
Spacer Kit, 1-3/8" Door (Int. & Ext. Gaskets)	EK1038	62	•	•	•	•	•	•	•	•	•
Internal power connector for hardwiring i-Qwik/i-Que Locksets	E1133	30	•	•	•	•	•	•	•	•	•
Memory Reset Jumper	E1155	21	•	•	•	•	•	•	•	•	•
Spacer Ring for 1-1/4" mortise cylinder	E2006	21				•	•	•	•	•	•
Spacer Ring for 1-3/8" mortise cylinder	E2007	21				•	•	•	•	•	•
Von Duprin 99 Rim Adapter Plate / M9900 Marks Detex Advantex 10 Series Rim Adapter Plate	E7071	80							•	•	•
Precision 1100 Rim Adapter Plate	E7072	80							•	•	•
Yale 7100 Rim Adapter Plate/ Corbin ED5200 Rim Adapter Plate	E7073	80							•	•	•
Dorma 9300 Rim Adapter Plate	E7074	80							•	•	•
Sargent 8800 Rim Adapter Plate/ Arrow 3800 Rim Adapter Plate	E7075	80							•	•	•
Precision 21 Rim Adapter Plate/ Precision 2100 Rim Adapter Plate**	E7076	80							•	•	•
Von Duprin 88 - Special Order, Consult Factory	E7077	80							•	•	•
Monarch 18R Exit Device Adapter Plate	E7078	91							•	•	•

NOTE: Consult Factory for Additional Exit Devices; **Must use Precision #BP21 backplate.

TAILPIECES & CAMS

CYLINDRICAL TAILPIECES Cylindrical Conventional				
FOR USE WITH		LEVER	CODE	PRICE
	Marks 1982	E1903	E1	7
	Arrow PK 100C, ILCO 705, Sargent 13-3266, Lori 1539, ASSA 65673, 65691, Abloy	E1903-L	E2	7
	Schlage® 23-001, Primus Corbin-Russwin 2000-034	EF1903-C	E3	7
CYLINDRICAL IC CORES				
	Kit for 6 & 7 pin Marks, KSP, Best®, Falcon, Medeco® Keymark, Schlage® Small Format, 6 pin Sargent	HER1984	ER	7
	Kit for 6 & 7 pin Corbin	HER1984-G	ERG	7
	Kit for 6 & 7 pin Yale™ American Lever ONLY	EAR1989-Y	EMY	9
	6 pin Schlage® Large Format American Lever ONLY	EF1903-F19	CM	9

CAMS				
Straight cam for tubular, exit device, or mortise functions Z1 & Z4 only.				
	USE WITH MORTISE CYLINDER	PART #	CODE	PRICE
	MARKS	2101	1	7
	Arrow/Sargent	2101-A	A1	7
	Corbin Russwin	2101-C	C1	7
	Schlage®	2101-S	S1	7
CAMS				
Cloverleaf cam for mortise functions Z2, Z3, Z5, Z6 only.				
	USE WITH MORTISE CYLINDER	PART #	CODE	PRICE
	MARKS	2102	2	7
	Arrow/Sargent	2102-A	A2	7
	Corbin Russwin	2102-C	C2	7
	Schlage®	2102-S	S2	7

REQUEST To EXIT (REX) CYLINDRICAL ELECTRIFIED LEVERSET

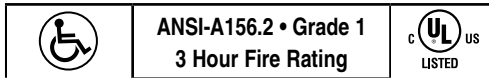

EA195 Series Leverset w/American Lever



Marks USA has developed the Grade 1 "Survivor" Series Cylindrical Lockset incorporating a Request to Exit (REX) switch in both Electrified and Storeroom functions. Activating the inside lever for egress initiates the built-in REX output, providing a momentary signal for the access control REX input, for alarm shunt during egress.

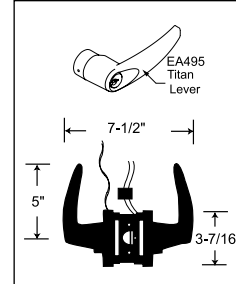
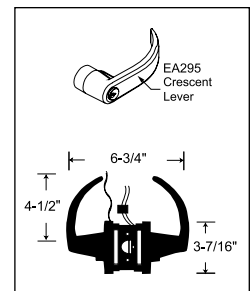
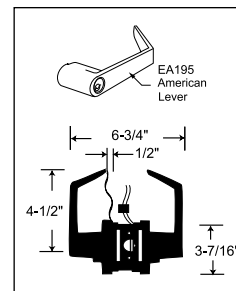

Standard Features

- Backsets: 2-3/4"; 2-3/8", 3-3/4" or 5" optional
- Latch #1834, Front: 1-1/8" x 2-1/4"; Throw: 9/16"; Stainless steel nose
- Levers: Solid cast Zamac w/ 1/2" return (except 395 & 495)
- Rose: Thru-bolted, 3-7/16" dia., spring loaded 2-#10 thru-bolts
- Strike: #1135, 4-7/8" ASA curved lip
- Door thickness: 1-5/8" to 1-7/8" (For 1-3/8" door use K1704 spacer)
- Cylinder: MARKS "C" keyway, 6 pin w/ 2 keys
- Request to Exit Switch: Single pole, double throw, 3 amp, 125 AC, wired either normally open or normally closed
- Electrified functions - 100% duty cycle, 24V/DC standard, supplied with bridge rectifier; 3 watts, .25amps
- 12V/DC Optional, Contact factory for additional options
- Features "The Clutch" • UL Listed, 3 hour fire rating

LOCKSET & LEVER DESIGN	CON. CORE	IC CORE	FUNCTION	ANSI #	DESCRIPTION	FINISH GROUPS	
						26D	3, 4, 10, 10B, 26
EA195 American lever	F	RF	STOREROOM	F86	Latch by lever inside. Outside lever always locked.	636	722
EA295 Crescent lever							
EA395 Monaco lever							
EA495 Titan lever							
EA195 American lever	FEL	RFEL	ELECTRICALLY LOCKED	—	Outside always locked electrically. Open by key outside, switch or loss of power. Latch by lever inside.	873	939
EA295 Crescent lever							
EA395 Monaco lever							
EA495 Titan lever							
EA195 American lever	FEU	RFEU	ELECTRICALLY UNLOCKED	—	Outside always locked until unlocked by key or electrically energized. Latch by lever inside.	873	939
EA295 Crescent lever							
EA395 Monaco lever							
EA495 Titan lever							

LEVERSETS ARE PACKED 6 PER CASE

* Standard IC Core Models: Interchangeable Core models for 6 or 7 pin cores (not included).
 Accepts: Marks, Medeco KeyMark™, Falcon & Best®.
 IC Core Tailpieces ARE Included.



Electrified Locksets

How To Order Example for REX Leversets

EA195	F	/	26D	—	G3
1. Lockset Series	2. Marks Function	Slash	3. Finish	Dash	4. Options

LOCK SERIES

- EA195
- EA295
- EA395
- EA495

MARKS FUNCTION

- ___ F ___ RFEL
- ___ RF ___ FEU
- ___ FEL ___ RFEU





FINISH

- 3 4
- 10 10B
- 26 26D

OPTIONS

ELECTRIFIED LOCKSETS

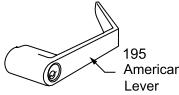
CYLINDRICAL LEVERSETS & MORTISE LOCKSETS

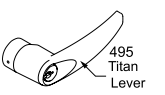
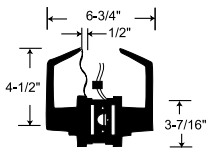
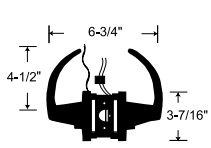
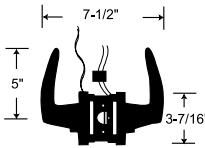
	ANSI-A156.2 • Grade 1 3 Hour Fire Rating		 195 American Lever	 295 Crescent Lever	 495 Titan Lever
195FEL/FEU Series Leverset w/American Lever					

Series 195, 295, 395, 495 Cylindrical Leverset Standard Features

- Backsets: 2-3/4", 2-3/8", 3-3/4", 5"
- Latch #1834, Front: 1-1/8" x 2-1/4"; Throw: 9/16"; Stainless steel nose
- Levers: Solid cast Zamac w/ 1/2" return
- Rose: Thru-bolted, 3-7/16" dia., spring loaded 2-#10 thru-bolts
- Strike: #1135, 4-7/8" ASA curved lip
- Door thickness: 1-5/8" to 1-7/8" (For 1-3/8" door use K1704 spacer)
- Cylinder: MARKS "C" keyway, 6 pin w/ 2 keys or IC Core housing
- Electrified functions - 100% duty cycle, 24V/AC supplied with bridge rectifier; 24V/DC, .21 Amps
- 12V/DC Optional, Contact factory for additional options
- Features "The Clutch"
- UL Listed, 3 hour fire rating

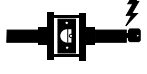
SERIES 195, 295, 395, 495 GRADE 1 ELECTRIFIED CYLINDRICAL LEVERSETS				FINISH GROUPS	
COMMERCIAL CYLINDER	IC CORE CYLINDER	MARKS FUNCTION	DESCRIPTION	3, 26D	4, 10, 10B, 26
FEL	RFEL	ELECTRICALLY LOCKED (Fail Safe)	Outside always locked electrically. Open by key outside, switch or loss of power. Deadlocking latch by lever inside. Lever only.	 	688 775
FEU	RFEU	ELECTRICALLY UNLOCKED (Fail Secure)	Outside always locked until unlocked by key or electrically energized. Deadlocking latch by lever inside. Lever only.		

* Standard IC Core Models: Accepts: Marks, Medeco KeyMark™, Interchangeable Core models Falcon & Best®. for 6 or 7 pin cores (not included). IC Core Tailpieces ARE Included.



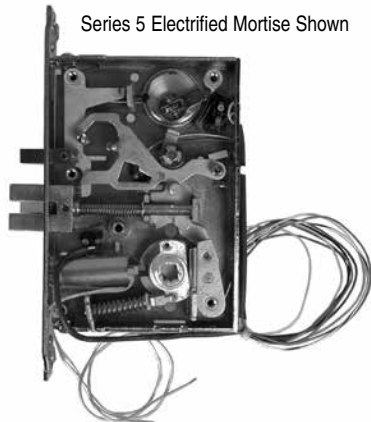

Series 5 Electrified Mortise Lockset Standard Features

- 2-3/4" Backset ONLY
- 1" Stainless steel bolt throw
- 3/4" Latch throw (anti-friction) separator
- 1/2" Auxiliary latch throw
- Stamped steel case .090 thick., Zinc dichromate finish
- 1-1/4" x 8" Lock front, Adjustable bevel
- Steel hubs, 9/32" on diamond, 5/16" on square w/security separator
- 100% Duty Cycle 24V/DC, 12V/DC Optional supplied with bridge rectifier (350 ma)



Series 5 Electrified Mortise Shown

OPTIONS	CODE	PRICE
Auxiliary Latch	E3	47
Request to EXit Switch	W10	140
Key Override Sensor	W11	148
Request to EXit switch, Key Sensor & Bolt Sensor	W13	468
Bolt Sensor	W14	171
Latch Sensor	W15	171

SERIES 5 ELECTRIFIED MORTISE LOCKSET			FINISH GROUPS	
MARKS FUNCTION	DESCRIPTION	3, 32D	10, 10B, 32	
EL: ELECTRICALLY LOCKED (Fail Safe)	Outside always locked electrically. Open by key outside, switch or loss of power. Auxiliary latch deadlocks latch. Inside always open.	 	896* 917*	
EU: ELECTRICALLY UNLOCKED (Fail Secure)	Outside always locked until unlocked by key or electrically energized. Auxiliary latch deadlocks latch. Inside always open.			

* Lock Body Price ONLY. Due to numerous trim and finish options, please refer to the Marks USA Mortise Lockset Price Book.

Electrified Locksets

GATE LOCKS (Reversible)

US PAT.#4,875,725 "NO FALL OUT" FEATURE:
Parts will not fall out when cover is removed.
Replaces Multilock gate locks.

Swinging Gate Locks

Standard Features

- Easily reversible
- Case, cast aluminum 3-5/8" x 6-1/4" x 1"
- Bronze powder coat finish
- Groove: 1/2" wide x 3/16" deep, all sides for wire gate insertion
- 5 pin cylinder(s)
- Lock only, no keeper furnished

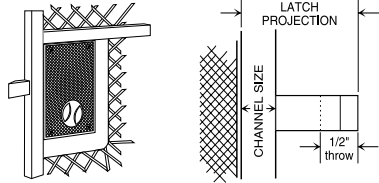

Single
Cylinder Model
*With cylinder
Suffix K
Add \$31

Double
Cylinder Model
*With cylinders
Suffix M
Add \$63

MODEL #	LATCH PROJECTION	CHANNEL SIZE	PRICE LESS CYL.*	WT. / LBS.
W3700	1-1/8"	1/2"	151	20
W3710	1-1/4"	5/8"	151	20
W3720	1-3/8"	3/4"	151	20
W3730	1-7/8"	1-1/4"	170	20
W3750	1-1/8"	1/2"	213	21
W3760	1-1/4"	5/8"	213	21
W3770	1-3/8"	3/4"	213	21
W3780	1-7/8"	1-1/4"	235	21

GATE LOCKS ARE PACKED 12 PER CASE

Sliding Gate Locks

Standard Features

- Easily reversible
- Case, cast aluminum 3-5/8" x 6-1/4" x 1"
- Bronze powder coat finish
- Groove: 1/2" wide x 3/16" deep, all sides for wire gate insertion
- 5 pin cylinder(s)
- Lock only, no keeper furnished

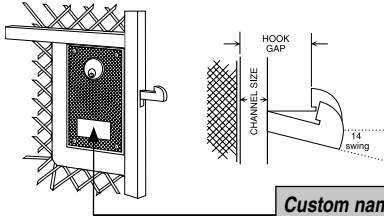

Single
Cylinder Model
*With cylinder
Suffix K
Add \$31

Double
Cylinder Model
*With cylinders
Suffix M
Add \$63

MODEL #	HOOK GAP	CHANNEL SIZE	PRICE LESS CYL.*	WT. / LBS.
W3800	.825"	1/2"	151	21
W3810	.950"	5/8"	151	22
W3820	1.075"	3/4"	151	21
W3830	1.625"	1-1/4"	170	22
W3850	.825"	1/2"	213	22
W3860	.950"	5/8"	213	22
W3870	1.075"	3/4"	213	22
W3880	1.625"	1-1/4"	235	22

GATE LOCKS ARE PACKED 12 PER CASE

Custom nameplate available.
Consult factory.

Parts

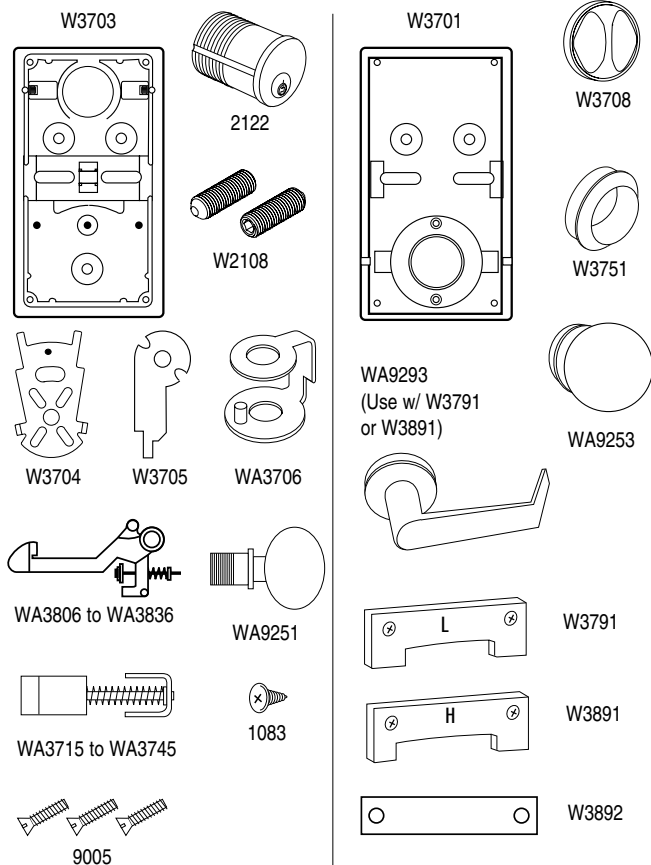

PART #	DESCRIPTION	PRICE
1083	Retainer/fork screw	.62
2122	Mortise cylinder	44
W2108	Cylinder set screw	.62
9005	Case screw	.62
W3701	Cover	44
W3703	Case	69
W3704	Fork	9
W3705	Latch lever	8
W3708	Turnpiece	23
W3751	Double cylinder collar with set screw	44
W3791	Lever stop plate - Swinging gate lock (w/W3892)	15
W3891	Lever stop plate - Sliding gate lock (w/W3892)	15
W3892	Lever slide cover	6
WA3706	Latch adapter	15
WA3715	Latch assembly - 1-1/8" projection	33
WA3725	Latch assembly - 1-1/4" projection	33
WA3735	Latch assembly - 1-3/8" projection	33
WA3745	Latch assembly - 1-7/8" projection	44
WA3806	Hook assembly - .825" gap	44
WA3816	Hook assembly - .950" gap	44
WA3826	Hook assembly - 1.075" gap	44
WA3836	Hook assembly - 1.625" gap	55
WA9251	Exterior knob assembly	90
WA9253	Interior knob assembly	90
WA9293	Interior lever assembly (with W3791 & W3891)	133

SERIES HA113 CUSTOM LOCK DIVISION

HOUSING AUTHORITY MORTISE LOCKSET

Custom Locksets

SERIES HA113			BHMA CERTIFIED
			FINISH GROUPS
MARKS #	FUNCTION	ANSI #	20A
KEYED SINGLE CYLINDER, NO DEADBOLT			
D	OFFICE VESTIBULE		578
DW	VESTIBULE		
E	OFFICE	F04	
EW	STOREROOM	F07	
GL	INST. PRIVACY	F26	
J	CLASSROOM	F05	
JM, JR	HOSPITAL (HOLDBACK)	F06	
EL	ELECTRICALLY LOCKED		1152
EU	ELECTRICALLY UNLOCKED		
KEYED SINGLE CYLINDER, WITH DEADBOLT			
A	ENTRANCE	F08, F10	593
B	ENTRANCE	F21	
F	DORMITORY	F12	
FS	DORMITORY		
FW	DORMITORY	F13	
FD	APARTMENT	F20	636
H	HOTEL	F15	
LH	SPEC. PRIVACY		
KEYED DOUBLE CYLINDER, NO DEADBOLT			
G	ENTRANCE	F09	636
GC	INTRUDER LATCHBOLT	F32	
GG	CLASSROOM SECURITY		
GR	CLASSROOM SECURITY w/HOLDBACK		
WW	INSTITUTION	F30	
KEYED DOUBLE CYLINDER, WITH DEADBOLT			
AC	ENTRANCE	F35	636
C	STOREROOM	F14	
FC	INTRUDER DEADBOLT	F34	
FA	DORMITORY	F11	
FX	DORMITORY	F33	
KEYLESS			
N	PASSAGE	F01	505
L	BATHROOM	F02	559
LF	PRIVACY	F19	
LJ	PRIVACY	F22	614
EX	EXIT	F31	578

For pricing, finishes and availability, consult factory

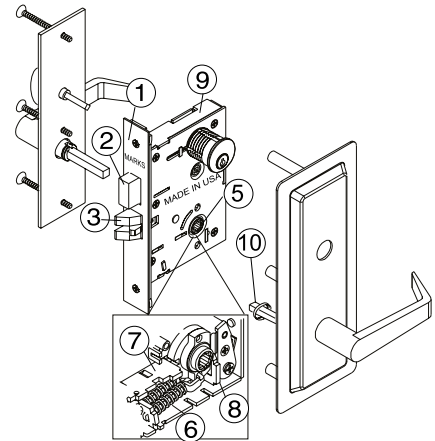

Performance Specifications:

Life Test: 1,500,000 cycles minimum.

ANSI Test: Meets or exceeds all operational and security tests of ANSI specifications A156.13-2005 for series 1000, Grade 1.

Fire Test: UL Listed, 3 hour fire rated.
Meets ADA requirements.



Trim Specifications:

"Barrier" Thru-bolted steel lever/plate assemblies with brass machined lever bearings. Screwless forged American levers, 4-1/2" long to meet ADA requirements, fastened to plates with hardened snap rings. Spring loaded 5/16" spindles (no set screws). Dark bronze powder coated finish.

Exterior: Wrought steel lever/plate assembly.

10-1/8" x 4" x 5/64" with 3 concealed welded thru-posts. Center post braces lock body for proper alignment in 1-3/4" thick door. Plate covers cylinder with only the keyway exposed.

Optional Exterior: Plate prepared for IC core cylinder.

Interior: Flat steel lever/plate assembly. 10-3/4" x 3-1/8" x 3/32" thick with 3 each 1/4"-20 mounting bolts. Center bolt passes through lock body to integrate trim with lock.

Cylinder: 1-1/8" long, 6 pin, solid brass with spacing collar concealed under exterior "Barrier" plate; 2 keys.

Strike: 4-7/8" x 1-1/4" x 3/32" thick, 5/8" curved lip. Conforms to ANSI spec., A115.1.

Door Thickness: 1-3/4" standard. Extended range available.

Lock Specifications: 5 Series (2-3/4" Backset)

1. Lock Front: Adjustable bevel steel backplate 1-1/4" x 8" x 7/64" thick. Cover plate 1/16" thick.

2. Deadbolt: Stainless steel w/hardened roll pins, 1" throw.

3. Latch: Solid stainless steel with antifriction latch lever, 3/4" throw (reversible).

4. Auxiliary deadlatch: 1/2" throw (reversible) - (not shown).

5. Hubs: Steel, 9/32" on diamond, 5/16" on square w/security separator.

6. Independent exterior and interior lever support springs.

7. Hub Follower: (to lock hub) steel 1/8" thick.

8. Hub Stop: (to limit lever travel) steel 1/8" thick.

9. Case: Stamped steel 3/32" thick, zinc dichromate finish.

10. Spindles: Independent spring-loaded spindles, 5/16" square.

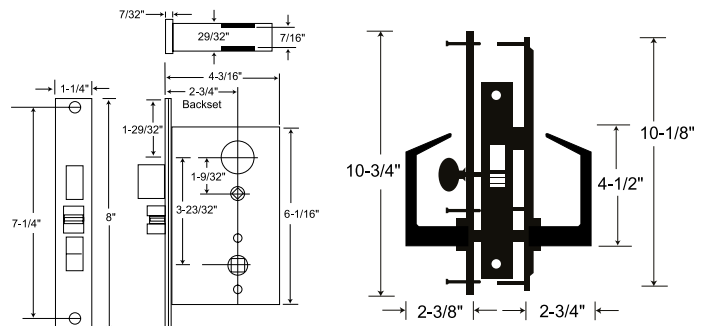

CUSTOM LOCK DIVISION

MAXIMUM SECURITY MORTISE LOCKSET

Series LA318GJ

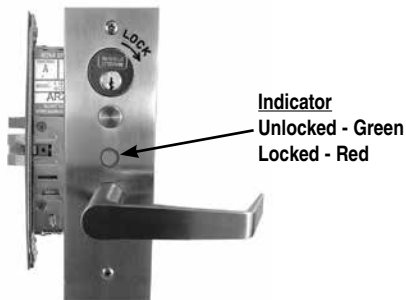

PERFORMANCE SPECIFICATIONS:

- LIFE TEST:** 1,500,000 cycles, minimum
- STRENGTH TEST:** 530 inch lbs. torque on exterior lever. When applied, lockset remains locked. (Torque of over 550 inch lbs. will cause spindle failure. However, lockset remains locked once spindle is replaced, lockset is fully operational.)
- ANSI TEST:** Certified to meet or exceed all operational and security tests of ANSI/BHMA A156.13-2012 for series 1000, Grade 1
- FIRE TEST:** UL listed, 3 hour fire rated. Meets ADA requirements.
- WARRANTY:** Lifetime mechanical limited warranty
All other functions available with latch, deadlatch and deadbolt combinations



FUNCTION SPECIFICATION: LA318GJ CLASSROOM INTRUDER

Latch by lever either side except when outside lever is locked from inside or outside by key. When locked, exterior key will retract latchbolt. Outside key locks or unlocks exterior lever. Inside key is single acting in one direction and will lock exterior lever only; will not unlock exterior lever. Auxiliary latch deadlocks latch. Inside always free for egress

TRIM: Cast satin stainless steel escutcheon 8-1/2"x2-3/4"x7/16". Recess in escutcheon to accept cylinder with rotating security cylinder ring. Cast screwless satin stainless steel lever handles to within 1/2" from face of door secured to escutcheon plate with hardened steel retainer ring. Lever handle, with spring-loaded torque sensitive 5/16" spindle. Integral torque override preventer recessed into escutcheon plate. Spindle will yield if excessive torque applied, preventing any damage to lock body.

EXTERIOR: Two 1/4" diameter threaded thru posts.
Two 1/4" diameter center posts pass thru lock body, automatically aligning trim.

INTERIOR: Two #10-32 phillips head stainless steel mounting thru bolts. Escutcheon with "LOCK" and directional arrow engraved and black filled near cylinder location. Occupancy indicator recessed into escutcheon plate. Indicator window to display unlocked (green day-glo) and LocDown™ (red day-glo) positions.

CYLINDERS: Two 1-1/8", 6-pin solid brass with 2101 cam int., 2105 cam ext., with two keys. Outside cylinder rotates in both directions. Inside cylinder rotates in one direction only. Cams supplied to accommodate Corbin™, Sargent™ and Schlage™ cylinders.

STRIKE: 4-7/8" X 1-1/4" X 3/32" thick, 5/8" curved lip.
Conforms to ANSI spec. 115.1.

DOOR THICKNESS: 1-3/4"

Lock Body: 5 series "GJ" function double cylinder lock. Lock handing completely reversible without opening lock case.

- Lock Front – Adjustable bevel steel backplate 1 1/4" x 8 x 7/64" thick. Cover plate 1/16" thick, with phillips screws
- Latch – solid stainless steel w/ antifriction latch lever 3/4" throw
- Auxiliary Deadlatch – 1/2" throw
- Case – stamped steel 3/32" thick
- Hubs – Steel, 9/32" on diamond, 5/16" on square w/ security separator
- Independent exterior and interior lever support springs

MARKS #	FUNCTION	List Price 32D
GJ	Classroom Security w/ Indicator Engraving	\$927
OPTIONS		Code Price
Less Cylinders		G3 -\$30
IC Core Housing		G1 N/C

HOW TO ORDER

Series Function / Finish Option
LA318 GJ / 32D - G3

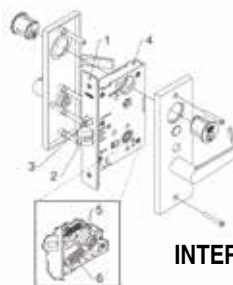

INTERIOR TRIM

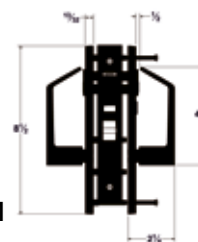

LA318			FINISH GROUPS
MARKS #	FUNCTION	ANSI #	32D
KEYED SINGLE CYLINDER, NO DEADBOLT			
D	OFFICE VESTIBULE		855
DW	VESTIBULE		
E	OFFICE	F04	
EW	STOREROOM	F07	
GL	INST. PRIVACY	F26	
J	CLASSROOM	F05	
JM, JR	HOSPITAL (HOLDBACK)	F06	1177
EL	ELECTRICALLY LOCKED		
EU	ELECTRICALLY UNLOCKED		
KEYED SINGLE CYLINDER, WITH DEADBOLT			
A	ENTRANCE	F08, F10	869
B	ENTRANCE	F21	
F	DORMITORY	F12	
FS	DORMITORY		
FW	DORMITORY	F13	
FD	APARTMENT	F20	892
H	HOTEL	F15	
LH	SPEC. PRIVACY		
KEYED DOUBLE CYLINDER, NO DEADBOLT			
G	ENTRANCE	F09	902
GC	INTRUDER LATCHBOLT	F32	
GG	CLASSROOM SECURITY		
GR	CLASSROOM SECURITY w/HOLDBACK		
WW	INSTITUTION	F30	927
GJ	CLASSROOM SECURITY		
KEYED DOUBLE CYLINDER, WITH DEADBOLT			
AC	ENTRANCE	F35	917
C	STOREROOM	F14	
FC	INTRUDER DEADBOLT	F34	
FA	DORMITORY	F11	
FX	DORMITORY	F33	
KEYLESS			
N	PASSAGE	F01	902
L	BATHROOM	F02	755
LF	PRIVACY	F19	
LJ	PRIVACY	F22	869
EX	EXIT	F31	813
DUMMY TRIM			
DI, DO	DUMMY TRIM INSIDE/OUTSIDE		384
DT	DUMMY TRIM		769

For pricing, finishes and availability, consult factory

SERIES BE101 & LA118 CUSTOM LOCK DIVISION

MAXIMUM SECURITY MORTISE LOCKSET

SERIES BE101 & LA118			BHMA CERTIFIED	
			FINISH GROUPS	
MARKS #	FUNCTION	ANSI #	32D	3, 10, 10B
KEYED SINGLE CYLINDER, NO DEADBOLT				
D	OFFICE VESTIBULE		803	838
DW	VESTIBULE			
E	OFFICE	F04		
EW	STOREROOM	F07		
GL	INST. PRIVACY	F26		
J	CLASSROOM	F05		
JM, JR	HOSPITAL (HOLDBACK)	F06		
EL	ELECTRICALLY LOCKED		1142	1229
EU	ELECTRICALLY UNLOCKED			
KEYED SINGLE CYLINDER, WITH DEADBOLT				
A	ENTRANCE	F08, F10	818	855
B	ENTRANCE	F21		
F	DORMITORY	F12		
FS	DORMITORY			
FW	DORMITORY	F13		
FD	APARTMENT	F20	842	879
H	HOTEL	F15		
LH	SPEC. PRIVACY			
KEYED DOUBLE CYLINDER, NO DEADBOLT				
G	ENTRANCE	F09	853	887
GC	INTRUDER LATCHBOLT	F32		
GG	CLASSROOM SECURITY			
GR	CLASSROOM SECURITY w/HOLDBACK			
WW	INSTITUTION	F30		
KEYED DOUBLE CYLINDER, WITH DEADBOLT				
AC	ENTRANCE	F35	853	887
C	STOREROOM	F14		
FC	INTRUDER DEADBOLT	F34		
FA	DORMITORY	F11		
FX	DORMITORY	F33		
KEYLESS				
N	PASSAGE	F01	697	731
L	BATHROOM	F02	818	855
LF	PRIVACY	F19		
LJ	PRIVACY	F22	757	793
EX	EXIT	F31	757	793
DUMMY TRIM				
DI, DO	DUMMY TRIM INSIDE/OUTSIDE		352	370
DT	DUMMY TRIM		705	793

For pricing, finishes and availability, consult factory

OPTIONS	CODE	PRICE
BE 1-1/2" thick for adapter plate	A19	80
Spacer kit for 1-1/2" thick door	K9311	780

2 Spacer kits are needed

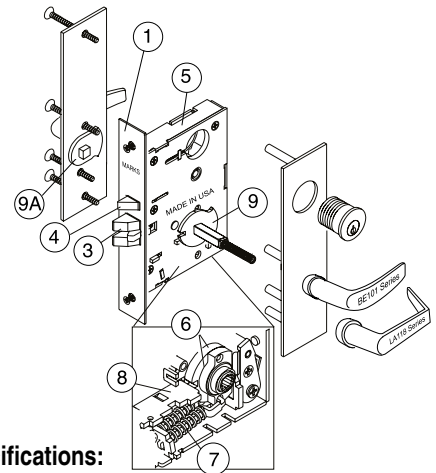

Performance Specifications:

Life Test: 1,500,000 cycles minimum.

ANSI Test: Meets or exceeds all operational and security tests of ANSI specifications A156.13-2005 for series 1000, Grade 1.

Fire Test: UL Listed, 3 hour fire rated.

Meets ADA requirements.



Trim Specifications:

"Barrier" Thru-bolted steel lever/plate assemblies with brass machined lever bearings. Screwless forged American levers, 4-1/2" long to meet ADA requirements, fastened to plates with hardened snap rings. Spring loaded 5/16" spindles (no set screws). Dark bronze powder coated finish.

Exterior: Wrought steel lever/plate assembly.

10-1/8" x 4" x 5/64" with 3 concealed welded thru-posts. Center post braces lock body for proper alignment in 1-3/4" thick door. Plate covers cylinder with only the keyway exposed.

Optional Exterior: Plate prepared for IC core cylinder.

Interior: Flat steel lever/plate assembly. 10-3/4" x 3-1/8" x 3/32" thick with 3 each 1/4"-20 mounting bolts. Center bolt passes through lock body to integrate trim with lock.

Cylinder: 1-1/8" long, 6 pin, solid brass with spacing collar concealed under exterior "Barrier" plate; 2 keys.

Strike: 4-7/8" x 1-1/4" x 3/32" thick, 5/8" curved lip. Conforms to ANSI spec., A115.1.



Door Thickness: 1-3/4" standard. Extended range available.

Lock Specifications: 5 Series (2-3/4" Backset)

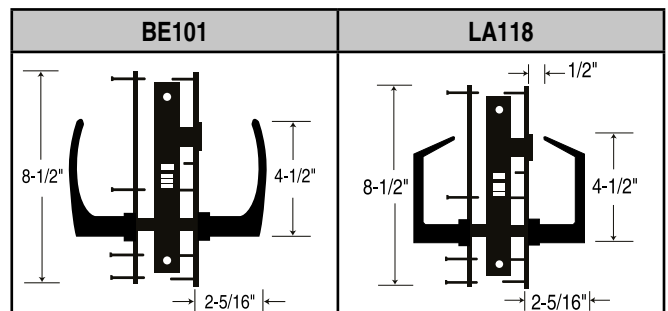
- Lock Front:** Adjustable bevel steel backplate 1-1/4" x 8" x 7/64" thick. Cover plate 1/16" thick.
- Deadbolt:** Stainless steel w/hardened roll pins, 1" throw.
- Latch:** Solid stainless steel with antifriction latch lever, 3/4" throw (reversible).
- Auxiliary deadlatch:** 1/2" throw (reversible) - (not shown).
- Hubs:** Steel, 9/32" on diamond, 5/16" on square w/security separator.
- Independent exterior and interior lever support springs.
- Hub Follower:** (to lock hub) steel 1/8" thick.
- Hub Stop:** (to limit lever travel) steel 1/8" thick.
- Case:** Stamped steel 3/32" thick, zinc dichromate finish.
- Spindles:** Independent spring-loaded spindles, 5/16" square.

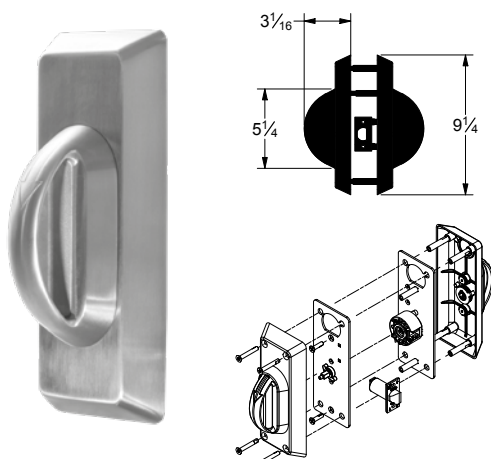

GRADE 1 195BH LifeSaver™ D-LIG SLIDE CYLINDRICAL LOCKSETS

BHMA CERTIFIED		ANSI-A156.2 • Grade 1 3 Hour Fire Rating		195BH SERIES
195SS Series Leversets Shown Below			Standard Features	
			<ul style="list-style-type: none"> • Rating: ANSI A156.2 Grade 1, UL Listed 3Hr Fire Rating • 5- Point Ligature Resistant slide Trim • Backset: 2 3/4" Standard, 2 3/8", 3 3/4" and 5" available • Latch: #1834, stainless Steel Nose • Ergonomic solid cast Stainless Steel Slide, Slides down freely in the locked or unlocked position • Escutcheon Plate solid cast Stainless Steel thru bolted for strength and easy installation • Designed to meet BHMA 156.34 Anti Ligature Trim Standard • Tamper Resistant mounting screws • Strike: #1135, 4 7/8" ASA curved lip Strike • Door Thickness: 1 3/4" • Cylinder: Marks C Keyway, 6 pin w/2 keys – Available in IC and All OEM cylinder preps • Marks Hi-Security Cylinder available • Marks Stainless Steel Retractor - Long life 3X the BHMA Grade 1 cycle Standard • Antimicrobial Finish available – Code AM • Marks Lifetime Mechanical Warranty • Available in Most BHMA ANSI Functions 	

SERIES 195BH					
MARKS #		DESCRIPTION	ANSI #	FINISH	PRICE
COMM. CYL.	ACCEPTS IC CORE CYL.*				
N	—	PASSAGE	F75	32D	1150
L	—	PRIVACY	F76		1170
B	RB	ENTRY	F82A		1300
S	RS	CLASSROOM	F84		1300
F	RF	STOREROOM	F86		1300
DW	RDW	INSTITUTION	F87		1450
DB	RDB	CLASSROOM INTRUDER	F110		1400
DO	—	DUMMY TRIM OUTSIDE	—		1100
DT	—	FULL DUMMY TRIM	—		550
NB	—	COMM. PASSAGE	F111		1120
FB	RFB	COMM. STOREROOM	F112		1190
SB	RSB	COMM. CLASSROOM	F113		1190
FEL	RFEL	ELECTRICALLY LOCKED			1450
FEU	RFEU	ELECTRICALLY UNLOCKED			1450

PACKED 6 PER CASE

OPTIONS	CODE	PRICE	OPTIONS	CODE	PRICE
For 2" doors	D1	50	Sargent conventional cylinder	F8	23
For 2-1/4" doors, Consult Factory	D2		Corbin conventional cylinder	F9	23
Over 2-1/4" - 4" thickness	D9	648	Corbin 6 pin IC core	F12	34
2-3/8" backset, 1" x 2-1/4" face	E6	NC	Yale 6 pin IC core	F14	23
5" backset, 9/16" throw, Gr. 1	E9	47	Sargent IC core	F20	23
3-3/4" backset, 9/16" throw, Gr. 1	E10	47	Medeco IC core large format	F21	23
Less cylinder	G3	Deduct 15	Schlage Large Format IC Core	F19	23
2-3/4" "T" strike	S3	NC	7-Pin Yale IC Core	F15	23

How To Order					
195BH	F	/	32D	—	G3
1. Lockset Series	2. Marks Function	Slash	3. Finish	Dash	4. Options



★ **Standard & HI-SECURITY™ IC Core Models:** Interchangeable Core models for 6 or 7 pin cores (not included). **Accepts:** Marks, Marks HI-SECURITY™, Medeco®, KeyMark™, Falcon, Schlage® small format & Best®. **IC Core Tailpieces ARE Included.**



Antimicrobial Finish Available
Option Code: AM

Institutional Life Safety

GRADE 1 SERIES 5BH D-LIG SLIDE MORTISE LOCKSET

INSTITUTIONAL LifeSaver™ MORTISE LOCKSETS

BHMA CERTIFIED		SERIES 5		UL LISTED		FINISH 32D	
MARKS #		FUNCTION		ANSI #		5BH	
KEYED SINGLE CYLINDER, NO DEADBOLT							
D	OFFICE VEST.					1700	
DW	VESTIBULE						
E	OFFICE		F04				
EW	STOREROOM		F07				
J	CLASSROOM		F05				
GL	INSTIT. PRIVACY		F26				
EL	ELECTRICALLY LOCKED					2030	
EU	ELECTRICALLY UNLOCKED						
KEYED SINGLE CYLINDER, WITH DEADBOLT							
A	ENTRANCE		F08, F10			1714	
B	ENTRANCE		F21				
F	DORMITORY		F12				
FS	DORMITORY						
FW	DORMITORY		F13				
KEYED DOUBLE CYLINDER, NO DEADBOLT							
G	APARTMENT		F09			1746	
GC	INTRUDER LATCHBOLT		F32				
GG	CLASSROOM SECURITY						
WW	INSTITUTIONAL		F30				
KEYED DOUBLE CYLINDER, WITH DEADBOLT							
AC	ENTRANCE		F35			1746	
C	STOREROOM		F14				
FA	DORMITORY		F11				
FX	DORMITORY		F33				
KEYLESS							
N	PASSAGE		F01			1603	
L	BATHROOM		F02			1714	
LF	PRIVACY		F19				
LJ	PRIVACY		F22			1659	
EX	EXIT		F31				
DUMMY TRIM							
DI	DUMMY TRIM INSIDE					500	
DO	DUMMY TRIM OUTSIDE						
DT	FULLY DUMMY					1120	

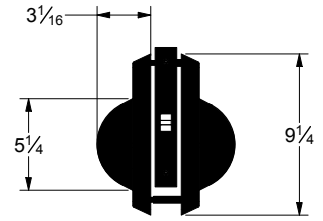
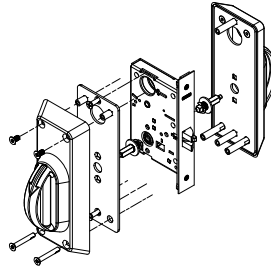

Performance Specifications:

- **Rating:** ANSI A156.13 Grade 1, UL Listed 3Hr Fire Rating
- 5- Point Ligature Resistant slide Trim
- **Backset:** 2 3/4" Standard, 2 1/2" Consult Factory
- **Latch:** #1834, stainless Steel Nose
- **Ergonomic solid cast Stainless Steel Slide**, Slides down freely in the locked or unlocked position
- **Escutcheon Plate solid cast Stainless Steel** thru bolted for strength and easy installation
- Designed to meet **BHMA 156.34 Anti Ligature Trim Standard**
- Tamper Resistant mounting screws
- Ligature Resistant ADA Thumbturn available where applicable
- **Strike:** #1135, 4 7/8" ASA curved lip Strike
- **Door Thickness:** 1 3/4"
- **Cylinder:** Marks C Keyway, 6 pin w/2 keys – Available in IC and All OEM cylinder preps
- Marks Hi-Security Cylinder available
- **Marks Stainless Steel Retractor** - Long life 3X the BHMA Grade 1 cycle Standard
- Antimicrobial Finish available – Code AM
- **Marks Lifetime Mechanical Warranty**
- Available in Most BHMA ANSI Functions

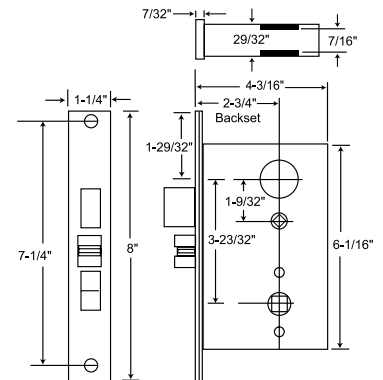

*** Standard & HI-SECURITY™ IC Core Models:** 
 Interchangeable Core models for 6 or 7 pin cores (not included).
Accepts: Marks, Marks HI-SECURITY™, Medeco®, KeyMark™, Falcon, Schlage® small format & Best®. **IC Core Tailpieces ARE Included.**

Antimicrobial Finish Available
Option Code: AM

How To Order

5BH	J	/	32D	—	G3
1. <i>Lockset Series</i>	2. <i>Marks Function</i>	<i>Slash</i>	3. <i>Finish</i>	<i>Dash</i>	4. <i>Options</i>



Institutional Life Safety

GRADE 1 195SS LifeSaver™ CYLINDRICAL LEVERSETS

		ANSI-A156.2 • Grade 1 3 Hour Fire Rating		195SS SERIES
195SS Series Leversets Shown Below			Standard Features	
			<ul style="list-style-type: none"> • ANSI-A156.2 Grade 1, UL listed 3 Hr. Fire Rating • Backset: 2-3/4" Standard, 2-3/8", 3-3/4", 5" Available • Latch #1834, stainless steel nose • Levers: Solid cast stainless steel. Levers Rotate up & down freely in locked or unlocked position • Levers recessed into solid stainless steel roses eliminating any open gap • Roses: Thru-bolted, spring loaded, #10 thru-bolts • Strike: #1135, 4-7/8" ASA curved lip strike • Door thickness: 1-3/4" +/- 1/16" • Cylinder: MARKS "C" keyway, 6 pin w/ 2 keys • Stainless steel retractor 	

SERIES 1S19					
MARKS #		DESCRIPTION	ANSI #	FINISH	PRICE
COMM. CYL.	ACCEPTS IC CORE CYL.*				
N	—	PASSAGE	F75	32D	838
L	—	PRIVACY	F76		860
LK	—	PRIVACY	F76 MOD.		887
P	—	PATIO	F77		855
DC	RDC	COMMUNICATING	F80		920
B	RB	ENTRY	F82A		877
AQ	—	EXIT	F83		865
S	RS	CLASSROOM	F84		877
F	RF	STOREROOM	F86		877
DW	RDW	INSTITUTION	F87		920
DA	RDA	VESTIBULE	F88		920
FQ	—	EXIT	F89		865
T	—	CORRIDOR	F90		887
TK	—	HOSPITAL/PRIV.	F90 MOD.		855
GB	RGB	STORE DOOR	F91		887
BS	RBS	SVC. STATION LOCK	F92		930
DO	—	DUMMY TRIM OUTSIDE	—		692
DT	—	FULL DUMMY TRIM	—		795
NB	—	COMM. PASSAGE	F111		817
FB	RFB	COMM. STOREROOM	F112		870
SB	RSB	COMM. CLASSROOM	F113	870	
FEL	RFEL	ELECTRICALLY LOCKED		1050	
FEU	RFEU	ELECTRICALLY UNLOCKED		1050	

PACKED 6 PER CASE

OPTIONS	CODE	PRICE	OPTIONS	CODE	PRICE
For 2" doors	D1	52	Sargent conventional cylinder	F8	24
For 2-1/4" doors, Consult Factory	D2		Corbin conventional cylinder	F9	24
Over 2-1/4" - 4" thickness	D9	667	Corbin 6 pin IC core	F12	35
2-3/8" backset, 1" x 2-1/4" face	E6	NC	Yale 6 pin IC core	F14	24
5" backset, 9/16" throw, Gr. 1	E9	48	Sargent IC core	F20	24
3-3/4" backset, 9/16" throw, Gr. 1	E10	48	Medeco IC core large format	F21	24
Less cylinder	G3	Deduct 15			
2-3/4" "T" strike	S3	NC			

How To Order					
195SS	F	/	32D	—	G3
1. Lockset Series	2. Marks Function	Slash	3. Finish	Dash	4. Options

★ **Standard & HI-SECURITY™ IC Core Models:** Interchangeable Core models for 6 or 7 pin cores (not included). **Accepts:** Marks, Marks HI-SECURITY™, Medeco®, KeyMark™, Falcon, Schlage® small format & Best®. **IC Core Tailpieces ARE Included.**





Antimicrobial Finish Available
Option Code: AM

Institutional Life Safety

SERIES 5SS55 KNOB & 5SS19 LEVER

INSTITUTIONAL LifeSaver™ MORTISE LOCKSETS

		SERIES 5				FINISH 32D	
MARKS #	FUNCTION	ANSI #	SS55 Knob	SS19 Lever			
KEYED SINGLE CYLINDER, NO DEADBOLT							
D	OFFICE VEST.		1098	1098			
DW	VESTIBULE						
E	OFFICE	F04					
EW	STOREROOM	F07					
J	CLASSROOM	F05					
GL	INSTIT. PRIVACY	F26					
EL	ELECTRICALLY LOCKED		1418	1418			
EU	ELECTRICALLY UNLOCKED						
KEYED SINGLE CYLINDER, WITH DEADBOLT							
A	ENTRANCE	F08, F10	1276	1276			
B	ENTRANCE	F21					
F	DORMITORY	F12					
FS	DORMITORY						
FW	DORMITORY	F13					
KEYED DOUBLE CYLINDER, NO DEADBOLT							
G	APARTMENT	F09	1128	1128			
GC	INTRUDER LATCHBOLT	F32					
GG	CLASSROOM SECURITY						
WW	INSTITUTIONAL	F30					
KEYED DOUBLE CYLINDER, WITH DEADBOLT							
AC	ENTRANCE	F35	1128	1128			
C	STOREROOM	F14					
FA	DORMITORY	F11					
FX	DORMITORY	F33					
KEYLESS							
N	PASSAGE	F01	1058	1058			
L	BATHROOM	F02	1258	1258			
LF	PRIVACY	F19					
LJ	PRIVACY	F22	1288	1288			
EX	EXIT	F31					
DUMMY TRIM							
DI	DUMMY TRIM INSIDE		584	584			
DO	DUMMY TRIM OUTSIDE						
DT	FULLY DUMMY		1165	1165			

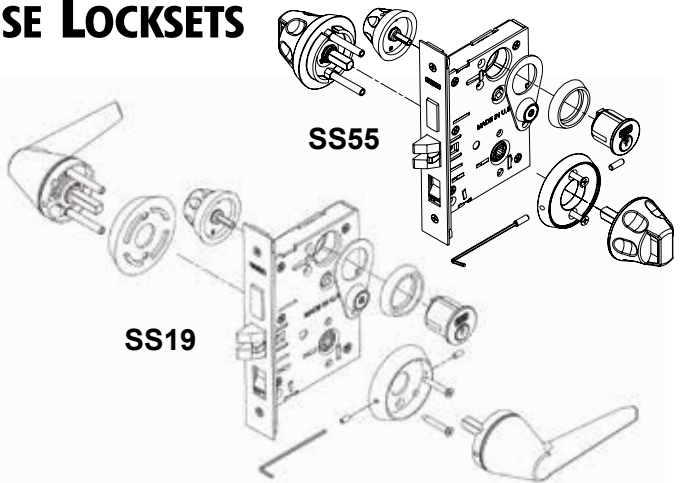

Performance Specifications:

Life Test: 1,500,000 cycles minimum.

ANSI Test: Meets or exceeds all operational and security tests of ANSI specifications A156.13-2005 for series 5000, Grade 1.

Trim Specifications:

Exterior & Interior Trim:

- Solid stainless steel interior and exterior tapered knobs or levers recessed into thru-bolted roses.
- Safety knobs with recessed grip and finger indents (*Patent #D587556*).
- Safety lever for handicapped access on clutch operated Mortise lock.
- Ergonomically designed grooved turn knob for deadbolt functions.

Cylinder: Solid stainless steel cylinders with solid stainless steel security collars; Optional HI-SECURITY™ cylinders available

Strike: 4-7/8" curved lip stainless steel w/tamperproof screws

Door Thickness: 1-3/4" standard; Extended range available

Door Prep: ANSI A115.1 lock face cutout, with 2-1/8" through hole for knob/rose assembly

Lock Specifications: 5 Series (2-3/4" Backset) 55 Series (2-1/2" Backset)

Lock Front: Adjustable bevel steel backplate 1-1/4" x 8" x 7/64" thick, Cover plate 1/16" thick with tamper proof screws

Latch: Solid stainless steel with antifiction latch lever, 3/4" throw (reversible)

Levers: Solid cast stainless steel. **Levers Rotate up & down freely in locked or unlocked position**

Aux. Deadlatch: 1/2" throw, (reversible)

Case: Stamped steel 3/32" thick, zinc dichromate finish

Hubs: Steel, 9/32" on diamond, 5/16" on square w/security separator

Hub Lock Arm: (to lock hub) Steel 1/8" thick

Spindles: Independent spring-loaded spindles

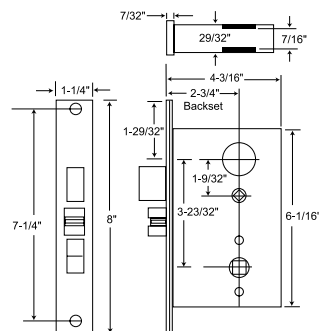

Antimicrobial Finish Available
Option Code: AM

Quick Privacy Access
A9618-1 Shown;
Option Code A25



★ **Standard & HI-SECURITY™ IC Core Models:** 
Interchangeable Core models for 6 or 7 pin cores (not included).
Accepts: Marks, Marks HI-SECURITY™, Medeco®, KeyMark™, Falcon, Schlage® small format & Best®. **IC Core Tailpieces ARE Included.**

How To Order						
5SS55 Knob	5SS19 Lever	J	/	32D	—	G3
1. Lockset Series	2. Marks Function	3. Slash	4. Dash	5. Finish	6. Options	

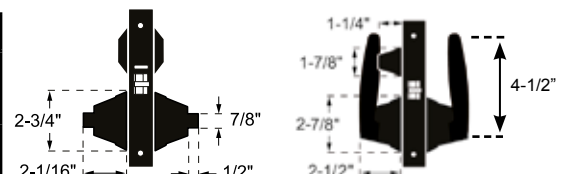

Institutional Life Safety

SERIES 180SS INSTITUTIONAL LifeSaver™ LOCKSETS

INSTITUTIONAL LIFE SAFETY CYLINDRICAL KNOBSETS & LOCKSETS

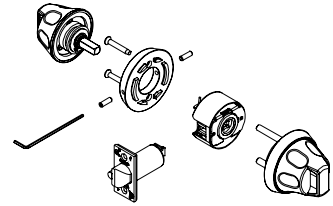

SERIES 180SS			FINISH GROUPS
MARKS #	FUNCTION	ANSI #	32D
KEYED SINGLE CYLINDER, WITH DEADBOLT			
K	CYLINDER x KNOB	E0121	1105
KEYLESS			
N	PASSAGE	F75	1105

★ **Standard & HI-SECURITY™ IC Core Models:** 
 Interchangeable Core models for 6 or 7 pin cores (not included).
Accepts: Marks, Marks HI-SECURITY™, Medeco®, KeyMark™, Falcon, Schlage® small format & Best®. **IC Core Tailpieces ARE Included.**

180SSK: Function E0121; Latch by knob inside, key outside.

180SSN: Function F75; Latch by knob either side, always open.

Antimicrobial Finish Available
Option Code: AM

Performance Specifications

- Life Test:** 1,500,000 cycles minimum.
- ANSI Test:** Meets or exceeds all operational and security tests of ANSI specifications A156.2-2003 for series 1000, Grade 1.

Fire Test: UL Listed, 3 Hour fire rated. 

Exterior & Interior Trim:

- Solid stainless steel interior and exterior tapered knobs recessed into thru-bolted roses
- Specially designed finger indented safety knobs with recessed grip and ergonomically designed integral grooved turn knob for elderly and handicapped access (*Patent #D587556*)
- Needle bearings ensure smoothness of operation

1SS55K Cylindrical Deadlatch Lockset: ANSI E0121 Cylinder x Knob

- Strike:** #1136, 2-3/4" "T" strike; #1135 4-7/8" ASA strike optional
- Door Prep:** ANSI 115.2
- Latch:** ANSI 156.2, Grade 1, 3 Hour fire rated
- Door Thickness:** 1-3/4"
- Backset:** 2-3/4" Backset; 3-3/4" and 5" backsets also available
- Latch Face:** 1-1/8" x 2-1/4" with tamper proof screws
- Cylinder:** Solid brass cylinder, 6-pin, "C" keyway; Optional HI-SECURITY™ cylinders available

1SS55N Cylindrical Lockset: ANSI F75 Passage

- Strike:** #1136, 2-3/4" "T" strike
- Door Prep:** ANSI 115.2
- Latch:** ANSI 156.2, Grade 1, 3 Hour fire rated
- Backset:** 2-3/4" backset standard, 2-3/8" backset optional; 3-3/4" and 5" backsets also available
- Latch Face:** 1-1/8" x 2-1/4" with tamper proof screws
- Latch Throw:** 9/16"

SERIES 31SS55 INSTITUTIONAL LifeSaver™ LOCKSETS

INSTITUTIONAL LIFE SAFETY MORTISE DEADLOCK

SERIES 31SS55			 FINISH GROUPS
MARKS #	FUNCTION	ANSI #	32D
KEYED SINGLE CYLINDER, WITH DEADBOLT			
K	CYLINDER x KNOB	E06071	460
S	CLASSROOM	E06091	490

31SS55K: Function E06071; Deadbolt by outside key. Interior safety knob will retract but not project deadbolt.

31SS55S: Function E06091; Deadbolt by outside key. Turnpiece will retract but not project deadbolt.

Performance Specifications:

- Life Test:** 1,500,000 cycles minimum.
- ANSI Test:** Meets or exceeds all operational and security tests of ANSI/BHMA Certified A156.5-2001 for series 31, Grade 1.

Fire Test: UL Listed, 3 Hour fire rated. 

Trim Specifications:

Interior Trim: Solid stainless steel interior trim including finger indented safety knobs which recess into solid brass through-bolted roses.

Series 31 Deadlock Specifications:

- Backset:** 2-3/4"
- Bolt throw:** 1" stainless steel w/hardened roll pins
- Case:** Stamped Steel
- Front:** 1-1/16" x 4-5/8" adjustable bevel
- Cylinder:** Solid brass cylinder, 6-pin, "C" keyway, 2 keys. Optional HI-SECURITY™ cylinders available.
- Strike:** #4035 Included

Antimicrobial Finish
Option Code: AM

★ **Standard & HI-SECURITY™ IC Core Models:** 
 Interchangeable Core models for 6 or 7 pin cores (not included).
Accepts: Marks, Marks HI-SECURITY™, Medeco®, KeyMark™, Falcon, Schlage® small format & Best®. **IC Core Tailpieces ARE Included.**

SERIES 180PD & 5PD HOSPITAL LifeSaver™ LOCKSETS

CYLINDRICAL & MORTISE PUSH/PULL PADDLESETS

Hospital Push/Pull Standard Features			
• 1-3/4" door thickness, self adjusting for thicker doors		• Non-Handed	
• Variable mounting positions		• Easily reversible configuration for push or pull styles	
180PD Cylindrical Standard Features		SERIES 180PD • ANSI-A156.2 • Grade 1	
• 2-3/4" backset std., 2-3/8", 3-3/4" & 5" optional			LEAD LINING & ENGRAVING AVAILABLE
• 2-3/4" "T" strike; 4-7/8" ASA strike optional			
• Government standard #161 door prep			
MARKS #	FUNCTION	ANSI #	FINISH: 32D Standard Consult Factory for Additional Finishes
N	PASSAGE	F75	328
PUSH/PULLS ARE PACKED 6 PER CASE			

5PD, 55PD Mortise Standard Features		SERIES 5PD, 55PD • ANSI-A156.13 • Grade 1	
• 5 Series Backset: 2-3/4"; 55 Series Backset: 2-1/2"			LEAD LINING & ENGRAVING AVAILABLE
• Strike: #9035, 4-7/8" ASA curved lip strike			
MARKS #	FUNCTION	ANSI #	FINISH: 32D Standard Consult Factory for Additional Finishes

KEYED SINGLE CYLINDER, NO DEADBOLT			
D	OFFICE VEST.		757
DW	VESTIBULE		
E	OFFICE	F04	
EW	STOREROOM	F07	
J	CLASSROOM	F05	
JM, JR	HOSPITAL	F06	
GL	INSTITUTIONAL PRIVACY	F26	1096
EL	ELECTRICALLY LOCKED		
EU	ELECTRICALLY UNLOCKED		

KEYED SINGLE CYLINDER, WITH DEADBOLT			
A	ENTRANCE	F08, F10	773
B	ENTRANCE	F21	
F	DORMITORY	F12	
FS	DORMITORY		796
FW	DORMITORY	F13	
FD	APARTMENT	F20	
H	HOTEL	F15	
LH	SPECIAL PRIVACY		

KEYED DOUBLE CYLINDER, NO DEADBOLT			
G	APARTMENT	F09	806
GC	INTRUDER LATCHBOLT	F32	
GG	CLASSROOM SECURITY		
GR	CLASSROOM SECURITY w/ HOLDBACK		
WW	INSTITUTIONAL	F30	

KEYED DOUBLE CYLINDER, WITH DEADBOLT			
AC	ENTRANCE	F35	806
C	STOREROOM	F14	
FC	INTRUDER DEADBOLT	F34	
FA	DORMITORY	F11	
FX	DORMITORY	F33	

KEYLESS			
N	PASSAGE	F01	652
L	BATHROOM	F02	773
LF	PRIVACY	F19	709
LJ	PRIVACY	F22	
EX	EXIT	F31	

How To Order					
5PD or 180PD	F	/	32D	—	G3
1. <i>Lockset Series</i>	2. <i>Marks Function</i>	<i>Slash</i>	3. <i>Finish</i>	<i>Dash</i>	4. <i>Options</i>

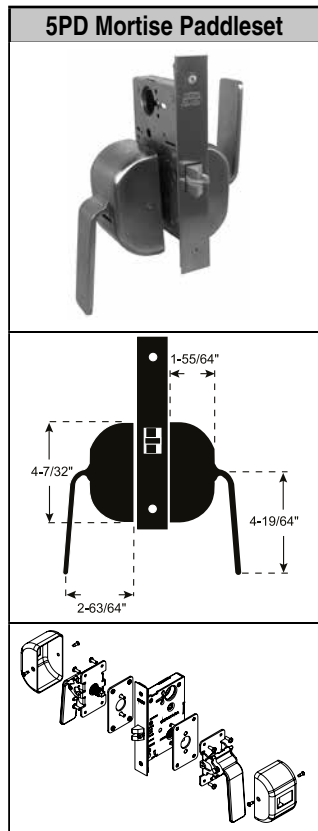
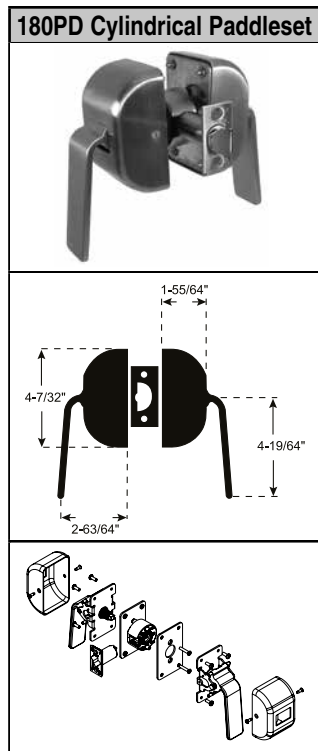

Hospital Push/Pull Paddlesets

MORTISE LOCK CYLINDERS

Cylinders

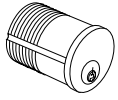

Mortise

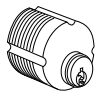

Concealed

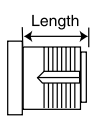

Length

IC Core Cylinder Housings

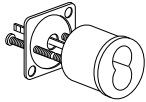

R662



Small Format
IC Core
6 or 7 Pin



RA3182
Schlage® format
IC Core

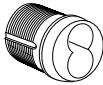

R2181

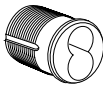

R2183

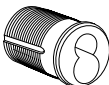

R4182

IC core pricing includes KA, KD or MK keying.

*** Standard & HI-SECURITY™ IC Core Models:** 
Interchangeable Core models for 6 or 7 pin cores (not included).
Accepts: Marks, Marks HI-SECURITY™, Medeco®, KeyMark™, Falcon, Schlage® small format & Best®. **IC Core Tailpieces ARE Included.**

PART #	DESCRIPTION	PINS	LENGTH	FINISH GROUPS		
				3, 26D	5, 10, 10B, 15, 26, 32D	3E
2122	Mortise	5	15/16"	50	53	73
2181	Mortise	6	2-7/8"	435	—	—
2182	Mortise	6	1-1/8"	55	61	76
2183	Mortise	6	1-1/4"	55	61	76
2193	Concealed	5	15/16"	73	—	—
2194	Concealed	6	1-1/8"	77	—	—
2196	Mortise	6	2-3/8"	303	—	—
2197	Mortise	6	1-3/4"	117	123	138
2198	Mortise	6	1-1/2"	94	97	117
662	Rim	6	—	55	61	—
* R2181	Mortise IC Core Housing	6	1"	55	61	—
* R2182	Mortise IC Core Housing	6	1-1/4"	50	53	—
* R2183	Mortise IC Core Housing	6 or 7	1-3/8"	50	53	—
* R2184	IC Core Cylinder Housing	6 or 7	1-3/4"	116	116	116
* R3182	Schlage® type IC Core, Uncombined	6	—	116	—	—
* R4182	Schlage® type IC Core Housing	6	1-1/2"	134	138	—
* R662	Rim IC Core Housing	6 or 7	1-3/8"	58	61	—
* R1182	6 Pin Core, Uncombined	—	—	44	—	—
* R1183	7 Pin Core, Uncombined	—	—	44	—	—
* RA1182	6 Pin Core, Combined	—	—	65	67	—
* RA1183	7 Pin Core, Combined	—	—	65	67	—
* RA3182	Schlage® type IC Core, Combined	6	—	138	—	—
* RC1182	6 Pin Core, Construction Core	—	—	46	—	—
* RC1187	Plastic Core Turn Knob	—	—	9	—	—
* RC3182	Schlage® type Construction Core	—	—	116	—	—
RM1182	Marketry Core	—	—	48	—	—

Cylinder Cams



2101



2102



2104



2105



2106



2107-CL

PART #	DESCRIPTION	USE WITH MORTISE LOCK	CODE	PRICE
2101	STRAIGHT CAM	MARKS	1	7
2101-A		ARROW/SARGENT	A1	7
2101-C		CORBIN RUSSWIN	C1	7
2101-S		SCHLAGE	S1	7
2102		CLOVERLEAF CAM	MARKS	2
2102-A	ARROW/SARGENT		A2	7
2102-C	CORBIN RUSSWIN		C2	7
2102-S	SCHLAGE		S2	7

PART #	DESCRIPTION	USE WITH MORTISE LOCK	CODE	PRICE
2104	ADAMS-RITE CAM	MARKS	4	7
2105	"J" FUNCTION CAM	MARKS	5	7
2105-A		ARROW/SARGENT	A5	7
2105-C		CORBIN RUSSWIN	C5	7
2105-S		SCHLAGE	S5	7
2107-CL		"J-CL" FUNCTION CAM	MARKS	7
2106	"G" CAM Exterior only	MARKS	6	7
2106-A		ARROW/SARGENT	A6	7
2106-C		CORBIN RUSSWIN	C6	7
2106-S		SCHLAGE	S6	7

Mortise Cylinders, Parts, Cams

How To Order Example for Mortise Lock Cylinders

2182	/	32D	—	1C
1. Cylinder	Slash	2. Finish	Dash	3. Options

See List Of
Cylinders
Available

FINISH
(Pg. 8)

- | | | |
|-----------------------------|------------------------------|------------------------------|
| <input type="checkbox"/> 3 | <input type="checkbox"/> 10 | <input type="checkbox"/> 26 |
| <input type="checkbox"/> 3E | <input type="checkbox"/> 10B | <input type="checkbox"/> 26D |
| <input type="checkbox"/> 5 | <input type="checkbox"/> 15 | <input type="checkbox"/> 32D |

Special

Specify

- Keying
- Door Thickness

Cam and keying information
must be included in the option section.

KEYS & KEYING

Keys

Can Stamp A Maximum Of 6 Characters On Key.

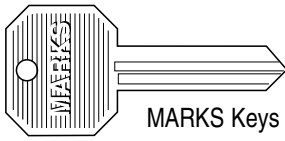

MARKS Keys

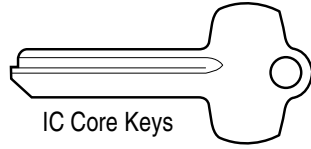

IC Core Keys

STANDARD KEYWAYS	PIN LENGTH ACCEPTS	SHOULDER INCREMENTS	PIN TO PIN TO 1st PIN	PLUG DISTANCE	DIAMETER
MARKS "A"	Arrow Kwikset Segal 9	.015"	.264"	.156"	.504"
MARKS "C"	Schlage "C"	.015"	.231"	.156"	.504"

Construction Master Keying:

The construction master key (CMK) is to be used temporarily while the building is under construction. When construction is completed, the end user defeats the CMK's operation by turning the change key in each cylinder, rather than replace or re-keying the cylinder.

Marks USA uses a program which is called the "lost ball" program. When construction key system is set up, three small ball bearings (construction balls) are placed between the bottom pin and master pin, normally in the last chamber as a "temporary master pin". The construction key is usually the same cut as the top master key with the exception of the sixth cut which is two increments higher. The construction master key will work in any cylinder until cylinder is "defeated" by making one full rotation in the cylinder with the change key. The cylinder plug requires a small diameter "pocket" drilled on one side of one pin chamber so when rotating the cylinder with the change key the pocket will capture the construction balls. The construction pocket in the plug is smaller than a pin chamber. This prevents any top pins or master pins from entering as the plug rotates. Once the cylinder is defeated, there is no way for the cylinder to be construction keyed again without disassembling it.

PART #	DESCRIPTION	PRICE	
		BLANK	CUT
2164A	MARKS "A" 5 PIN BRASS	6	8
2164C	MARKS "C" 5 PIN BRASS, NICKEL PLATED	6	8
2184A	MARKS "A" 6 PIN NICKEL SILVER	7	9
2184C	MARKS "C" 6 PIN NICKEL SILVER	7	9
R1164	IC CORE 6 OR 7 PIN (SMALL FORMAT)	7	9
R3164	SCHLAGE® IC CORE CONTROL KEY	7	9

BEST® A thru M keyway. Please specify.
IC Core pricing includes KA, KD or MK Keying.

PART #	DESCRIPTION	PRICE	
		REGULAR	IC CORE
KA	KEYED ALIKE	NC	NC
KD	KEYED DIFFERENT	NC	NC
MK	MASTER KEYED	22	NC
CMK	CONSTRUCTION MASTER KEYED (Includes GMK or MK)	32	—
GMK	GRAND MASTER KEYED	22	14
GGMK	GREAT GRAND MASTER KEYED	22	14
GGGMK	GREAT GREAT GRAND MASTER KEYED	22	—
HK	HOTEL KEYED (Guest, Maid, Emergency)	29	—
KEYING TO A SPECIFIC CODE NUMBER		16	16
STAMPING		PRICE	
LETTERS/NUMBERS ON KEY		8 PER KEY	
US PROPERTY - "DO NOT DUPLICATE"		8 PER KEY	
VISUAL KEY CONTROL (VKC)		7	
CONCEAL KEY CONTROL		16	
EXTRA CUT KEYS WITH LOCKSET		SEE KEYS ABOVE	
KEY BITTING CODE LIST		260	

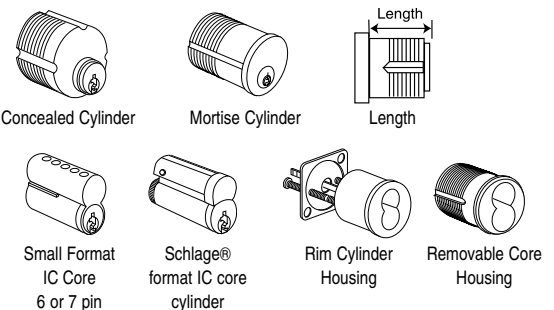
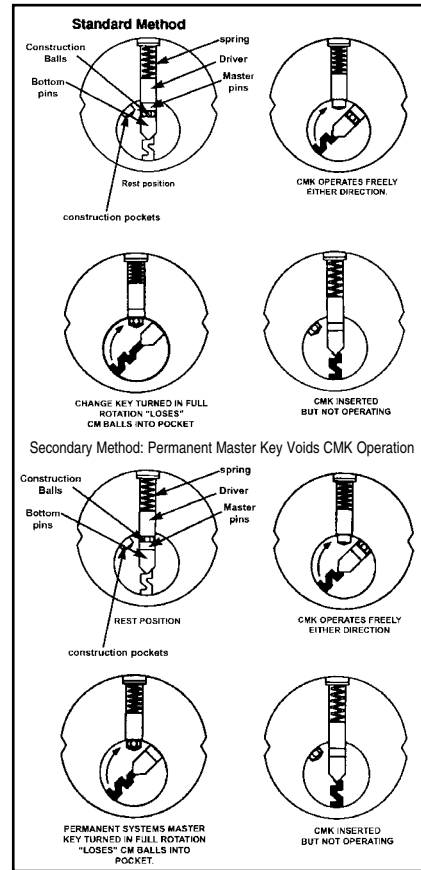

IC CORE PRICING INCLUDES KA, KD OR MK KEYING

*** Standard & HI-SECURITY™ IC Core Models:** Interchangeable Core models for 6 or 7 pin cores (not included).
Accepts: Marks, Marks HI-SECURITY™, Medeco®, KeyMark™, Falcon, Schlage® small format & Best®. **IC Core Tailpieces ARE Included.**

HI-SECURITY™ CYLINDERS: NON-UL



HI-SECURITY™ MORTISE CYLINDERS						
	NON-UL "0" Bitted x 2 Keys; "0" Bitted "NO KEYS" - Deduct \$7		FINISH GROUPS			
	PART #	DESCRIPTION	3, 26D	4, 5, 10, 10B, 15, 26, 32D	3E	
	BXXX-D001A0N2	1-1/8" Mortise Cylinder	74	80	94	
	CXXX-D001A0N2	1-1/4" Mortise Cylinder	80	87	100	
	DXXX-D001A0N2	1-3/8" Mortise Cylinder	93	98	112	
	LXXX-D001A0N2	1-1/2" Mortise Cylinder	104	109	123	
	MXXX-D001A0N2	1-3/4" Mortise Cylinder	116	124	136	
	NON-UL KD x 2 Keys					
	BXXX-D001A1N2	1-1/8" Mortise Cylinder	81	89	104	
	CXXX-D001A1N2	1-1/4" Mortise Cylinder	89	93	108	
DXXX-D001A1N2	1-3/8" Mortise Cylinder	101	106	121		
LXXX-D001A1N2	1-1/2" Mortise Cylinder	111	116	132		
MXXX-D001A1N2	1-3/4" Mortise Cylinder	111	130	143		

HI-SECURITY™ CYLINDERS ARE PACKED 24 PER CASE

HI-SECURITY™ MORTISE/RIM COMBO CYLINDERS						
	NON-UL "0" Bitted x 2 Keys; "0" Bitted "NO KEYS" - Deduct \$7		FINISH GROUPS			
	PART #	DESCRIPTION	3, 26D	4, 5, 10, 10B, 15, 26, 32D	3E	
	EXXX-D001A0N2	1" Combo Cylinder	67	72	88	
	FXXX-D001A0N2	1-1/8" Combo Cylinder	80	87	100	
	NON-UL KD x 2 Keys					
	EXXX-D001A1N2	1" Combo Cylinder	75	80	94	
	FXXX-D001A1N2	1-1/8" Combo Cylinder	89	93	108	

HI-SECURITY™ CYLINDERS ARE PACKED 24 PER CASE

HI-SECURITY™ KIK CYLINDERS					
	NON-UL "0" Bitted x 2 Keys; "0" Bitted "NO KEYS" - Deduct \$6		FINISH GROUPS		
	PART #	DESCRIPTION	26D		
	G26D-D001X0N2	Key-In-Knob Cylinder	61		
	NON-UL KD x 2 Keys				
	G26D-D001X1N2	Key-In-Knob Cylinder	67		

HI-SECURITY™ CYLINDERS ARE PACKED 24 PER CASE

HI-SECURITY™ MARKS IC CORE CYLINDERS					
	NON-UL "0" Bitted x 2 Keys x 1 Control Key; "0" Bitted "NO KEYS" - Deduct \$6		FINISH GROUPS		
	PART #	DESCRIPTION	26D		
	H26D-D001X0N2	6 Pin IC Core Cylinder	67		
	J26D-D001X0N2	7 Pin IC Core Cylinder	70		
	NON-UL KD x 2 Keys x 1 Control Key				
	H26D-D001X1N2	6 Pin IC Core Cylinder	78		
J26D-D001X1N2	7 Pin IC Core Cylinder	81			

HI-SECURITY™ CYLINDERS ARE PACKED 24 PER CASE

HI-SECURITY™ Schlage® LARGE FORMAT IC CORE CYLINDERS					
	NON-UL "0" Bitted x 2 Keys x 1 Control Key; "0" Bitted "NO KEYS" - Deduct \$6		FINISH GROUPS		
	PART #	DESCRIPTION	26D		
	K26D-D001X0N2	6 Pin Schlage® IC Core Cylinder	85		
	NON-UL KD x 2 Keys x 1 Control Key				
	K26D-D001X1N2	6 Pin Schlage® IC Core Cylinder	95		

HI-SECURITY™ CYLINDERS ARE PACKED 24 PER CASE

HI-SECURITY™ Medeco® LARGE FORMAT IC CORE CYLINDERS				
	NON-UL "0" Bitted x 2 Keys x 1 Control Key; "0" Bitted "NO KEYS" - Deduct \$6		FINISH GROUPS	
	PART #	DESCRIPTION	26D	
	P26D-D001X0N2	6 Pin Medeco® IC Core Cylinder	104	
	NON-UL KD x 2 Keys x 1 Control Key			
P26D-D001X1N2	6 Pin Medeco® IC Core Cylinder	115		

HI-SECURITY™ CYLINDERS ARE PACKED 24 PER CASE

HI-SECURITY™ CYLINDERS: UL 437



HI-SECURITY™ MORTISE CYLINDERS					
	UL 437 "0" Bitted x 2 Keys; "0" Bitted "NO KEYS" - Deduct \$7		FINISH GROUPS		
	PART #	DESCRIPTION	3, 26D	4, 5, 10, 10B, 15, 26, 32D	3E
	BXXX-D001A0U2	1-1/8" Mortise Cylinder	93	98	112
	CXXX-D001A0U2	1-1/4" Mortise Cylinder	95	101	115
	DXXX-D001A0U2	1-3/8" Mortise Cylinder	111	117	132
	LXXX-D001A0U2	1-1/2" Mortise Cylinder	117	127	141
	MXXX-D001A0U2	1-3/4" Mortise Cylinder	135	139	153
	UL 437 KD x 2 Keys				
	BXXX-D001A1U2	1-1/8" Mortise Cylinder	101	106	121
	CXXX-D001A1U2	1-1/4" Mortise Cylinder	104	110	123
	DXXX-D001A1U2	1-3/8" Mortise Cylinder	120	124	138
	LXXX-D001A1U2	1-1/2" Mortise Cylinder	130	135	149
MXXX-D001A1U2	1-3/4" Mortise Cylinder	142	148	163	

HI-SECURITY™ CYLINDERS ARE PACKED 24 PER CASE

HI-SECURITY™ MORTISE/RIM COMBO CYLINDERS					
	UL 437 "0" Bitted x 2 Keys; "0" Bitted "NO KEYS" - Deduct \$7		FINISH GROUPS		
	PART #	DESCRIPTION	3, 26D	4, 5, 10, 10B, 15, 26, 32D	3E
	EXXX-D001A0U2	1" Combo Cylinder	87	91	105
	FXXX-D001A0U2	1-1/8" Combo Cylinder	98	104	117
	UL 437 KD x 2 Keys				
	EXXX-D001A1U2	1" Combo Cylinder	93	98	112
FXXX-D001A1U2	1-1/8" Combo Cylinder	106	111	112	

HI-SECURITY™ CYLINDERS ARE PACKED 24 PER CASE

HI-SECURITY™ KIK CYLINDERS			
	UL 437 "0" Bitted x 2 Keys; "0" Bitted "NO KEYS" - Deduct \$7		FINISH GROUPS
	PART #	DESCRIPTION	26D
	G26D-D001X0U2	Key-In-Knob Cylinder	77
	UL 437 KD x 2 Keys		
G26D-D001X1U2	Key-In-Knob Cylinder	87	

HI-SECURITY™ CYLINDERS ARE PACKED 24 PER CASE

HI-SECURITY™ Schlage® LARGE FORMAT IC CORE CYLINDERS			
	UL 437 "0" Bitted x 2 Keys x 1 Control Key; "0" Bitted "NO KEYS" - Deduct \$6		FINISH GROUPS
	PART #	DESCRIPTION	26D
	K26D-D001X0U2	6 Pin Schlage® IC Core Cylinder	100
	NON-UL KD x 2 Keys x 1 Control Key		
K26D-D001X1U2	6 Pin Schlage® IC Core Cylinder	111	

HI-SECURITY™ CYLINDERS ARE PACKED 24 PER CASE

HI-SECURITY™ Medeco® LARGE FORMAT IC CORE CYLINDERS			
	UL 437 "0" Bitted x 2 Keys x 1 Control Key; "0" Bitted "NO KEYS" - Deduct \$6		FINISH GROUPS
	PART #	DESCRIPTION	26D
	P26D-D001X0U2	6 Pin Medeco® IC Core Cylinder	119
	NON-UL KD x 2 Keys x 1 Control Key		
P26D-D001X1U2	6 Pin Medeco® IC Core Cylinder	132	

HI-SECURITY™ CYLINDERS ARE PACKED 24 PER CASE

HI-SECURITY™
Cylinders

HI-SECURITY™ CYLINDERS





Security-Mate™ & SPECIAL APPLICATION CYLINDERS

Security-Mate™ MORTISE CYLINDERS				
	"0" Bitted "NO KEYS"		FINISH GROUPS	
	PART #	DESCRIPTION	3, 26D	4, 5, 10, 10B, 15, 26, 32D
	BXXX-DXXXXA0N0	1-1/8" Mortise Cylinder	58	63
	CXXX-DXXXXA0N0	1-1/4" Mortise Cylinder	63	67
	DXXX-DXXXXA0N0	1-3/8" Mortise Cylinder	74	80
	LXXX-DXXXXA0N0	1-1/2" Mortise Cylinder	87	50
	MXXX-DXXXXA0N0	1-3/4" Mortise Cylinder	98	104
Security-Mate™ CYLINDERS ARE PACKED 24 PER CASE				

Security-Mate™ MORTISE/RIM COMBO CYLINDERS				
	"0" Bitted "NO KEYS"		FINISH GROUPS	
	PART #	DESCRIPTION	3, 26D	4, 5, 10, 10B, 15, 26, 32D
	EXXX-DXXXXA0N0	1" Combo Cylinder	48	55
	FXXX-DXXXXA0N0	1-1/8" Combo Cylinder	63	67
	Security-Mate™ CYLINDERS ARE PACKED 24 PER CASE			

Security-Mate™ KIK CYLINDERS			
	"0" Bitted "NO KEYS"		FINISH GROUPS
	PART #	DESCRIPTION	26D
	G26D-DXXXXX0N0	Key-In-Knob Cylinder	45
Security-Mate™ CYLINDERS ARE PACKED 24 PER CASE			

Security-Mate™ MARKS IC CORE CYLINDERS			
	"0" Bitted "NO KEYS"		FINISH GROUPS
	PART #	DESCRIPTION	26D
	H26D-DXXXXX0N0	6 Pin IC Core Cylinder	50
	J26D-DXXXXX0N0	7 Pin IC Core Cylinder	55
Security-Mate™ CYLINDERS ARE PACKED 24 PER CASE			

Security-Mate® Schlage™ LARGE FORMAT IC CORE CYLINDERS			
	"0" Bitted "NO KEYS"		FINISH GROUPS
	PART #	DESCRIPTION	26D
	K26D-DXXXXX0N0	6 Pin Schlage® IC Core Cylinder	69
Security-Mate™ CYLINDERS ARE PACKED 24 PER CASE			

Security-Mate® Medeco™ LARGE FORMAT IC CORE CYLINDERS			
	"0" Bitted "NO KEYS"		FINISH GROUPS
	PART #	DESCRIPTION	26D
	P26D-DXXXXX0N0	6 Pin Medeco® IC Core Cylinder	89
Security-Mate™ CYLINDERS ARE PACKED 24 PER CASE			

HI-SECURITY™ SPECIAL APPLICATION CYLINDERS					
	KA Pair w/ 2 Keys, NON-UL, Straight Cam			FINISH GROUPS	
	PART #	DESCRIPTION	3, 26D	5, 15	
	2122XXXHSM	15/16" Mortise Cylinders	145	150	
HI-SECURITY™ SPECIAL APPLICATION CYLINDERS ARE PACKED 24 PER CASE					

HI-SECURITY™
Cylinders

HI-SECURITY™ CYLINDERS

HOW TO ORDER HI-SECURITY™ CYLINDERS AND KEYS

How To Order Example for HI-SECURITY™ Cylinders								
D	3	—	D	001	A	3	U	2
1. Cylinder Type	2. Finish	Dash	3. Keyway	4. Security Code	5. Cam Tail	6. Keying	7. NON-UL / UL437	8. # of Keys

CYLINDER TYPE	FINISH	KEYWAY	SECURITY CODE	CAM TAIL <i>MORTISE</i>	KEYING	UL or NON-UL	KEYING
<input type="checkbox"/> B = 1-1/8" Mortise <input type="checkbox"/> C = 1-1/4" Mortise <input type="checkbox"/> D = 1-3/8" Mortise <input type="checkbox"/> L = 1-1/2" Mortise <input type="checkbox"/> M = 1-3/4" Mortise <input type="checkbox"/> E = 1" Combo <input type="checkbox"/> F = 1-1/8" Combo <input type="checkbox"/> G = KIK Cylinder <input type="checkbox"/> H = IC Core Marks 6 Pin <input type="checkbox"/> J = IC Core Marks 7 Pin <input type="checkbox"/> K = IC Core Schlage® Large Format <input type="checkbox"/> P = IC Core Medeco® Large Format	<input type="checkbox"/> 3 <input type="checkbox"/> 4 <input type="checkbox"/> 5 <input type="checkbox"/> 10 <input type="checkbox"/> 10B <input type="checkbox"/> 15 <input type="checkbox"/> 26 <input type="checkbox"/> 26D <input type="checkbox"/> 32 <input type="checkbox"/> 32D	<input type="checkbox"/> D = HS	<input type="checkbox"/> 001 = MARKS	<input type="checkbox"/> A = 2101 <input type="checkbox"/> B = 2102 <input type="checkbox"/> D = 2104 <input type="checkbox"/> E = 2105 <input type="checkbox"/> F = 2106 <i>KIK</i> <input type="checkbox"/> A = Standard Tail <input type="checkbox"/> B = Classroom Tail <input type="checkbox"/> C = i-Que Electronic <i>IC CORE</i> <input type="checkbox"/> A = 6 Pin IC <input type="checkbox"/> B = 7 Pin IC	<input type="checkbox"/> 0 = "0" Bitted <input type="checkbox"/> 1 = KD <input type="checkbox"/> 2 = KA <input type="checkbox"/> 3 = CMK <input type="checkbox"/> 4 = GMK <input type="checkbox"/> 5 = MK <input type="checkbox"/> 6 = GGMK	<input type="checkbox"/> U = UL 437 <input type="checkbox"/> N = NON UL	<input type="checkbox"/> 0 = "0" Bitted <input type="checkbox"/> 1 = 1 Key <input type="checkbox"/> 2 = 2 Keys <input type="checkbox"/> 3 = 3 Keys Up to 9, Then as separate line item

How To Order Example for HI-SECURITY™ Keys				
HS	6	D	001	C
1. Key Type	2. Pins	3. Keyway	4. Security Code	5. Special Key Type
<input type="checkbox"/> HS = HI-SECURITY™ <input type="checkbox"/> RS = IC Core	<input type="checkbox"/> 5 Pin <input type="checkbox"/> 6 Pin <input type="checkbox"/> 7 Pin	<input type="checkbox"/> D = HS	<input type="checkbox"/> 001 = Marks	<input type="checkbox"/> C = Control Key

HI-SECURITY™
Cylinders







HI-SECURITY™ CYLINDERS









KEYS, CAMS & TAILPIECES

KEYS			
	PART #	DESCRIPTION	PRICE
	HS5D001	5 Pin Key Blank	9
	HS6D001	6 Pin Key Blank	9
	RS6D001	6 Pin IC Key Blank	9
	RS7D001	7 Pin IC Key Blank	9
	Schlage® IC CORE CONTROL KEY		
HSR3184	6 or 7 Pin IC Key Blank	9	
CUT KEYS			
Conventional Cylinder			12
IC Core Cylinder			12

KEYING CHARGES		
PART #	DESCRIPTION	PRICE
KA, KD	Keyed Alike, Keyed Different	NC
MK	Master Keyed	22
GMK	Grand Master Keyed	22
GGMK	Great Grand Master Keyed	22
VKC	Visual Key Control	15

MORTISE CYLINDER CAMS			
PART #	DESCRIPTION	PRICE	
 2101HS	Straight Cam	6	
 2102HS	Clover Cam	6	
 2104HS	Adams Rite Cam	6	
 2105HS	J - Cam	6	
 2106HS	G - Cam	6	
 2107-CLHS	Straight Cam	6	

Schlage® LARGE FORMAT IC CORE HOUSING CAMS			
PART #	DESCRIPTION	PRICE	
 2101 HSPM	Straight Cam	6	
 2102 HSPM	Clover Cam	6	
 2104 HSPM	Adams Rite Cam	6	
 2105 HSPM	J - Cam	6	
 2106 HSPM	G - Cam	6	
 2107-CL HSPM	Straight Cam	6	

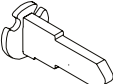
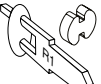
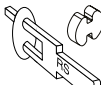
CYLINDRICAL TAIL PIECES			
PART #	FUNCTIONS	PRICE	
 F1903-C	AB, DW, F	8	
 F1903S-C	S, DA, DB, DC, SB, T	8	
IC CORE TAILPIECES			
 HR1984-HS	AB, B, DA (ext.), DW, F, FEU, FEL	8	
 HR1984S-HS	S, DA (int.), DB, DC, SB, T	8	

HI-SECURITY™
Cylinders

HI-SECURITY™ CYLINDERS



PARTS LIST

PARTS LIST			
PART #	DESCRIPTION	PRICE	PACKED
P2031	Finger Pins #1 (Silver)	26	25 per pack
P2032	Finger Pins #2 (Copper)	26	25 per pack
P2033	Finger Pins #3 (Black)	26	25 per pack
P2034	Finger Pins #4 (Gold)	26	25 per pack
P2035	Sidebar - Schlage® IC	26	25 per pack
P2036	Sidebar - Combo, KIK, Mortise	26	25 per pack
P2051	Sidebar - Best® IC	26	25 per pack
P2037	Sidebar Springs	26	50 per pack
P2044	Mortise Cam Screws	15	12 per pack
P2045	IC Mortise Cam Screws - SCHLAGE® ONLY	15	12 per pack
P2038	Hardened Steel Pins	15	12 per pack
P2041	Schlage® IC Cap Pin	26	12 per pack
P2042	Schlage® IC Cap Pin Spring	26	12 per pack
P2046	Schlage® IC Screw Cap	26	6 per pack
P2048	KIK Screw Cap	26	6 per pack
P2043	Best® IC Clip	26	12 per pack
P2039	Top Hex Screws (HI-SECURITY™ Mortise)	15	12 per pack
P2040	Top Hex Screws (HI-SECURITY™ Best® IC)	15	12 per pack
P2047	HI-SECURITY™ Registration Card	40	10 cards
R2984	7 Pin IC Tailpiece (AB, DW, F)	6	—
R2984S	7 Pin IC Tailpiece (S, DA, DB, DC, SB, T, TS)	6	—
R1981	Spacer	6	—
K2030	Parts Kit	285	—
2049	Plug Holder	40	—
BXXX-D133B1N1C	Cut Away Mortise Cylinder	111	—
BXXX-D133B1N1P	Plastic Mortise Cylinder	111	—
HSICT	Shear Tool	228	—
HSC387	HPC Card C387	50	—

HI-SECURITY™
Cylinders

SERIES M9900 EXIT DEVICE

RIM MOUNT



- EXTRUSION HEAVY GAGE 32D FINISH
- LIFETIME MECHANICAL WARRANTY
- PANIC PROTECTOR™ END CAP
- EASY INSTALLATION, ECONOMICAL



MARKS #	FUNCTION	PRICE	
		32D	10B
M9900	Rim Panic	432	503
M9900F	Fire Rated Rim Panic	487	558
M9900 - 48	Rim Panic - 48"	476	547
M9900F - 48	Fire Rated Rim Panic - 48"	533	604

OPTIONS	
M9900	33" Length for 38" Door
M9900-48"	42" Length for 48" Door

SPECIFICATIONS
• Doors: 1 3/4" thick standard
• End Cover: Stainless steel beveled "Panic Protector" design
• Strike: Roller strike
• Rail Assembly: Heavy Gauge Stainless Steel
• Dead latch Bolt: Stainless Steel 3/4" throw.
• Dead latch Bolt: Stainless Steel 5/8".
• Dogging feature: Allen Key (M9900)
• UL listed: For "Panic Hardware" and Fire Rated Model 3 hour fire doors up to 38" x 86".
• ANSI: ANSI 156.3 (2001), requirements for Grade 1
• 3 Hour Fire Rating
• Finished: Stainless steel satin finish

SERIES M9900 VR EXIT DEVICE

SURFACE VERTICAL ROD









APPLICATION
• For use on single door or pair of doors
• 1 3/4" (44 mm) door thickness standard. Specify thickness other than 1 3/4"
• RHR or LHR hollow metal, wood and mineral core doors
• Minimum Stile Width: 3 1/2" (89 mm)

MARKS #	FUNCTION	PRICE	
		32D	10B
M9900 VR	Rim Panic Vertical Rod	574	639
M9900F VR	Fire Rated Rim Panic Vertical Rod	631	702
M9900 - 48 VR	Rim Panic Vertical Rod - 48"	602	673
M9900F - 48 VR	Fire Rated Rim Panic Vertical Rod - 48"	359	726
M9900 VR ER	Vertical Rod Electric Latch Retraction	2835	2910

SPECIFICATIONS
• Device Head Cover: Zinc alloy or stainless steel
• Chassis: Steel, plated
• Mechanism Housing: Extruded aluminum
• Push Bar Base: Extruded aluminum
• Touch Plate: Stainless Steel
• End Cap: Stainless Steel
• Top Latch: Stainless Steel 37/64" (14.8mm)
• Top Strike: Included
• Bottom Latch: Stainless Steel 37/64" (14.8mm)
• Bottom Strike: Included
• Latch Case Covers: Steel, stainless steel or brass
• Vertical Rods: Aluminum tube
• Hand: Non-handed
• Mounting: Machine screws standard. Sex bolts optional. Order "SNB" for wood or unreinforced metal doors
• Dogging: Allen-type key furnished
• Finish: 32D
• Outside Trim: Order separately
• Standard Height: 7' doors
• UL listed: ANSI/BHMA Grade 1 Panic Exit Hardware
• 3-Hour Fire Rated

Exit Devices

SERIES M9900 EXTERIOR TRIM

M411	Lever/Rose	Rim Panic Vandal Pull
	 M195F	MVP/32D 
MES600A	Cylindrical Dogging Kit - 32D	Rim Panic Vandal Pull w/ cylinder hole
	 M9901 M9902	MVPCC/32D (cylinder not included) 

ENTRY LEVER TRIM





- Standard Marks "C" Keyway KNK cylinder for panic device.
- Cylinder locks or unlocks lever, rigid when locked; when unlocked retracts latch bolt.
- Marks 26D Finish / Standard 1-3/4" Door Thickness
- IC Prep Code G1, Less Cylinder G3

ESCUTCHEON LEVER DESIGN

- Thru bolt design
- Non Handed design. Easily field reversible.
- Marks 32D Finish / Standard 1-3/4" Door Thickness
- Standard Marks "C" Keyway 1-1/4 Mortise cylinder with special cam
- IC Prep Code G1
- Less Cylinder G3

MARKS #	DESCRIPTION	PRICE	
		26D	10B
M411	Finger Pill - no cylinder	23	26
MESC600A	Lever / Escuteon Trim Entry	132	175
MESC600F	Lever / Escuteon Trim Storeroom	132	175
MESC600N	Lever / Escuteon Trim Passage	114	159
MESC600DT	Lever / Escuteon Trim Dummy Trim	114	159
M9901	36 inch Panic Device Dogging Kit	82	98
MVR8	Vertical Rod 8 ft extension - Code 8	41	—
MVR10	Vertical Rod 10 ft extension - Code 10	66	—
MVRB	Vertical Rod - Bottom Rod	28	—
MVP/32D	Rim Panic Vandal Pull	197	—
MVPCC/32D	Rim Panic Vandal Pull w/ cylinder hole	219	—

MORTISE CYLINDER CAMS

M9907		MESC600A
M9908		MESC600F
M9909		MESC600F IC CORE HOUSING
M9910		MESC600A IC CORE HOUSING

SERIES M8800 EXIT DEVICE

THIN LINE TM RIM MOUNT

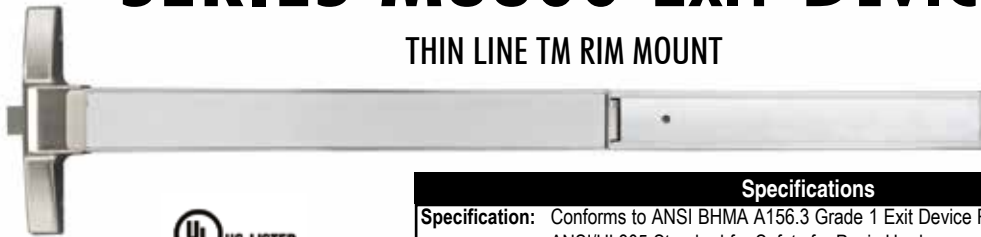

MARKS #	FUNCTION	PRICE
		32D
M8800	Rim Panic	466

Specifications

Specification: Conforms to ANSI BHMA A156.3 Grade 1 Exit Device Requirement Standard
ANSI/UL305 Standard for Safety for Panic Hardware
2013 California Building Code Sec. 11B-309.4

For Doors: (Please specify when ordering non standard size doors)
Thickness: Standard 1 3/4", may fit with door thickness up to 2"
Width: Standard 36" or 48", may fit door width 30"-48"

Mounting: Furnished Standard with Wood and Machine Screws

Head Cover: Zinc Alloy

Chassis: Aluminum

Rail Assembly: Heavy Gauge extruded aluminum with stainless steel on top of touch bar

End Cap: Zinc Alloy

Hand: Non-handed

Latch Bolt: Stainless Steel, 3/4" (18mm) throw

Strike: Roller Strike (Stainless Steel)

Dogging: Allen Key (equipped on panic rate devices only)

Finish: 32D: Satin Stainless Steel Finish
10B: Oil Rubbed Bronze Finish

Dimension: Touch bar height from finished floor: 41" (1041mm) from center of touch bar
Touch Bar Projection: Neutral: 3 5/16" (84mm)
Depressed: 2 19/32" (66mm)
Head Cover: LxWxH: 206mm x 76mm x 71mm
Device Length: 34 5/8" (88cm) for 36" door width
46 5/8" (118.5 cm) for 48" door width

Exit Devices

SERIES M195 EXIT DEVICE TRIM

Specifications

Levers: Solid cast Zamac, with 1/2" return (except 495)
Roses: Thru-bolted, 3-7/16" spring loaded Roses
Door Thickness: 1-5/8" – 1-7/8"
Clutch: Standard
Chassis: Aluminum
Cylinder: MARKS "C" keyway, 6 pin w/ 2 keys
 IC Core model - Core not included
Lifetime Mechanical Warranty

MARKS #	Trim	26D	19E
M195S/295/495	Entry	164	207
M195F/295/495	Storeroom	164	207
M195N/295/495	Passage	152	185
M195DT/295/495	Dummy	152	185

OPTIONS	CODE	PRICE - 195	295	395	495
Yale Conventional	F7	24	—	—	—
Sargent conventional cylinder	F8	24	23	—	—
Corbin conventional cylinder	F9	24	23	—	—
Corbin 6 pin IC core	F12	35	33	—	—
Corbin 7 pin IC core	F13	35	—	—	—
Yale 6 pin IC core	F14	24	23	—	—
Yale 7 pin IC core	F15	24	—	—	—
Schlage 6 pin IC core	F19	24	23	—	—
Sargent IC core	F20	24	23	—	—
Medeco IC core large format	F21	24	23	—	—
Less Cylinder	G3	Deduct 15	—	—	—

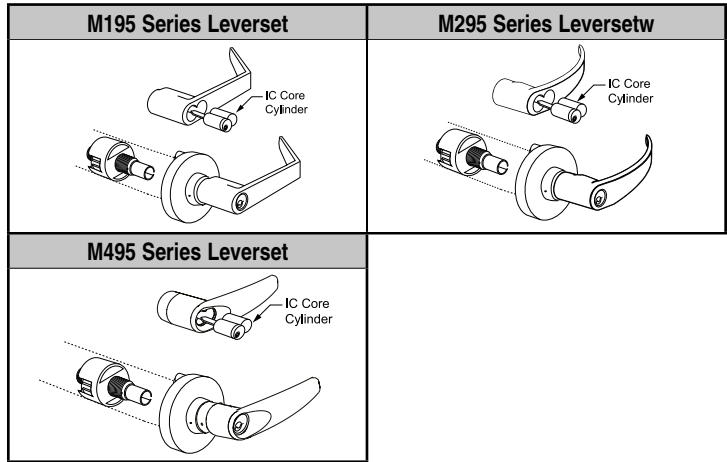

★ **Standard & HI-SECURITY™ IC Core Models:** Interchangeable Core models for 6 or 7 pin cores (not included). **Accepts:** Marks, Marks HI-SECURITY™, Medeco®, KeyMark™, Falcon, Schlage® small format & Best®. **IC Core Tailpieces ARE Included.**



SERIES M99 NIGHT LATCH TRIM

MARKS #	Trim	26D
M99F/32D-G3		180
M99DO/32D		170

ELECTRIC LATCH RETRACTION

WITH SIMULTANEOUS DOGGING



Rim Mount & Mortise

UL US LISTED ADA

DEVICE SPECIFICATIONS	
ER	Electric Latch Retraction with simultaneous dogging
For:	M9900
Operation:	Momentary or maintained latch bolt and push pad retraction. Automatic re-triggering of latch retraction
Voltage:	24VDC @ 450 mA activation, 180 mA continuous
602RF	1 Amp power supply (1 EMC max)
632RF	2 Amp power supply (2 EMC max)
EMC	2-station sequencer required for automatic doors only.
Monitoring Available	Latch status and REX output available

MARKS #	DESCRIPTION	PRICE
HEAVY DUTY		
M9900ER	Electric Latch Retraction	2673
M9900ERP	Electric Latch Retraction w 602 Power Supply	3373

Exit Devices

EXIT ALARM



Door sign included, Bar sign optional

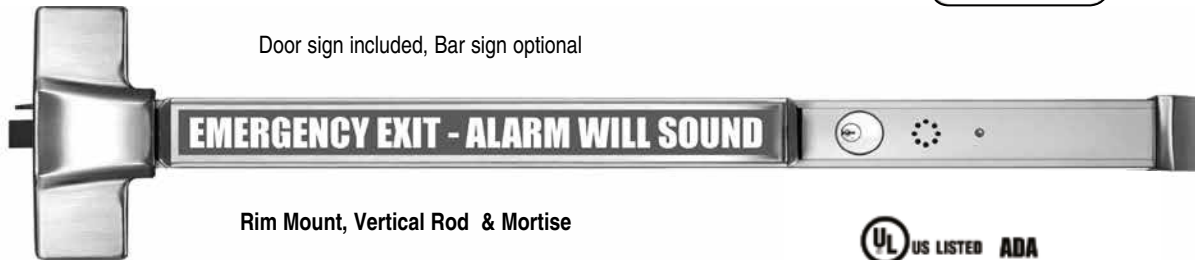

Rim Mount, Vertical Rod & Mortise

UL US LISTED ADA

DEVICE SPECIFICATIONS	
EA	Exit Alarm, 9V battery powered
EB	Exit Alarm, 12-24V AC/DC input, 9V battery backup
For:	M9900
	<ul style="list-style-type: none"> • 100 dB alarm; visual and audible On/Off status: Armed - green LED blinks every 4 seconds, Alarm mode - red LED, Bypass - no LED • Remote status output • 15 or 60 second arming delay • 2 modes: Continuous alarm with manual key reset; Automatic re-arm 2 minutes after door closes with any manual key reset before 2 minutes.
Options:	<ul style="list-style-type: none"> • Push pad sign • 6, 10 & 20 minutes alarm; 1 or 5 second re-arm delay • Remote access control, arm, disarm inputs • REX and latch status outputs

MARKS #	DESCRIPTION	PRICE
HEAVY DUTY		
M9900EA	Exit Alarm 9VDC	1638
M9900EB	Exit Alarm 9VDC w 12/24 AC/DC Input	1679

ELECTRIC DOGGING



UL US LISTED ADA

Rim Mount, Vertical Rod & Mortise

DEVICE SPECIFICATIONS
<p>DG Electric Dogging (failsecure) M9900, When energized by optional built-in or remote switch manual, depressing the pushpad, causes the pushpad and latch to remain retracted (unlocked) providing push-pull door operation. When de-energized or signaled by a fire alarm, the pushpad and latch are released.</p> <p>Voltage: 170/100 mA @ 12/24VDC</p> <p>Monitoring Available: Latch status and REX output available</p>

MARKS #	DESCRIPTION	PRICE
HEAVY DUTY		
M9900DG	Electric Dogging, Fail Secure	1875
M9900DGP	Electric Dogging, Fail Secure w 602 Power Supply	2575

Exit Devices

DELAYED EGRESS



Rim Mount, Vertical Rod & Mortise

DEVICE SPECIFICATIONS	
DE	Wall mount delayed egress controller with keypad and electrified exit device, M9900, M9900VR
Example:	M9900F/32D-DE
DEK	Keypad controller with redundant key switch capable of all keypad control features
602RF	1 Amp power supply
	<ul style="list-style-type: none"> User PIN codes may be assigned to 1, 2 or all control functions. Reset, sustained bypass and momentary bypass (RES) Audible alarm voice release time, warning or safety message Visual display countdown, locked/unlocked, egress executed 15 or 30 second exit delay, 1 or 2 second nuisance delay 2 minutes
	Monitoring Available: Latch status available

MARKS #	DESCRIPTION	PRICE
HEAVY DUTY		
M9900DE	Delayed Egress	2673
M9900KDE	Delayed Egress w Keyswitch	2874
M9900DEP	Delayed Egress w 602 Power Supply	3373
M9900KDEP	Delayed Egress w Keyswitch W 602 Power Supply	3574
M9900VRDE	Delayed Egress	2951
M9900VRKDE	Delayed Egress w Keyswitch	2194
M9900VRDEP	Delayed Egress w 602 Power Supply	2688
M9900VRKDEP	Delayed Egress w Keyswitch W 602 Power Supply	2894

Exit Devices

M9900 LITE



Adapter plate included

MARKS #	FUNCTION	PRICE
M9900LITE	Rim Panic with IQ7LITE	977

IQ7LITE

IQ7 LITE Rim Exit Device Interface Specifications

Door Thickness: 1-3/4" standard; For thicker doors, Consult factory

Handing: Non-handed

Key Override: 1-1/8" Mortise cylinder, 6 pin w/2 keys

Clutch: The "Clutch" for trouble free service

M9900

- **Doors:** 1-3/4" thick standard.
- **End cover:** Flush mounted beveled "Panic Protector" design.
- **Strike:** Roller strike.
- **Rail Assembly:** Extruded Aluminum, 32D finish.
- **Dead latch Bolt:** Stainless Steel 3/4" throw.
- **Dead latch Bolt:** Stainless Steel 5/8".
- **Dogging feature:** Allen Key (M9900)
- **UL listed:** For "Panic Hardware" and Fire Rated Model 3 hour fire doors up to 38" x 86".
- **ANSI:** ANSI 156.3 (2001), requirements for Grade 1.
- **3 Hour Fire Rating**
- **Finish:** 32D

POWER TRANSFER HINGE



10B Listed for 3hr Fire Rated Door

CODE	DESCRIPTION	PRICE
P1	Power Transfer Hinge MPTH - 4	161
P2	Power Transfer hinge MPTH - 10	211
PTH-4	Four conductor hinge	165
PTH-10	Ten conductor hinge	211

FEATURES

- UL10B Listed for 3 Hr Fire Doors. If the hinge you are presently using does not bear the F mark, it is not listed for use with fire doors.
- 500,000 cycles. 5 times UL test criteria
- Wire Replacement Warranty
- 5ft wire cable

APPLICATION

Installed in the center hinge position of the door, PTH Power Transfer Hinges provide the concealed wires required between the door and the frame, for the purpose of powering and monitoring electric door hardware.

- Electric Lock Power and Control
- Door and Lock Status Signaling
- Request-to-Exit Signaling

PTH-4 Four conductor hinge, 1 Amp @ 12/24V per pair, 4.5" x 4.5" five knuckle standard weight

PTH-10 Ten conductor hinge, 1 Amp @ 12/24V per pair, 4.5" x 4.5" standard weight

Consult factory for 3 knuckle, or special size

Finish

All base material steel
Aluminum, Duranodic, US 3, 10B, 26D & 32D finishes

Options

DPS Concealed Door Position Switch SPDT, 250mA @ 30VDC



FIRE RATED CONCEALED MORTISE POWER TRANSFER

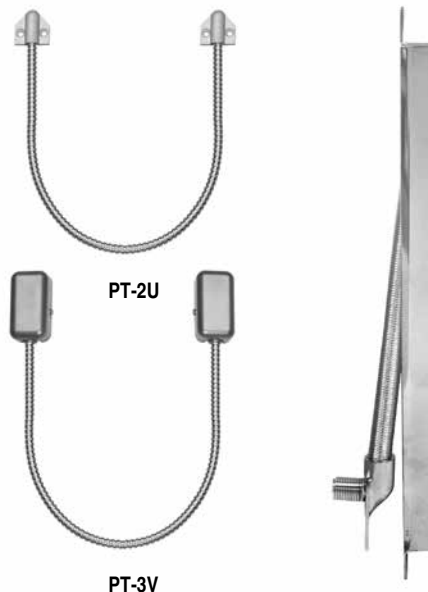

CODE	DESCRIPTION	PRICE
P3	Power Transfer loop MPT-2U	20
P4	Power Transfer Loop MPT-3V	43
PT-2U	Power Transfer Loop with end caps	26
PT-3V	PTL w/ aluminum wire termination box	52
PT-5	Concealed Mortise Power Transfer Loop	67
602 C	Access Control Power Supply and Charger	340

FEATURES

PT-5 Concealed Mortise Mount Power Transfer Loop

Frame mortised steel dust box with flexible steel loop and chrome finish. Recommended for use with hollow metal frames. UL Listed

Dimensions: 11.5"H x 1"W x 0.75"D (292 x 25.4 x 19mm)
10B Listed For 3 Hrs Fire Rated Doors



POWER TRANSFER LOOPS

18" (447mm) stainless steel armored flex conduit with small plastic end caps or termination box. Recommended for use with hollow metal and aluminum frames.

PT-2U With end caps

PT-3V With aluminum wire termination box

602 C POWER SUPPLY

Access Control Power Supply and Charger, Selectable 12/24VDC, 1 Amp, Emergency Release Input, Low Battery Disconnect, 12" x 12" x 4" Cabinet, UL, Class 2



Options: Key locked cover; 6 ft power cord; cover or interior mounted on-off switches; manual reset switches; 7 day, skip a day timer; Rechargeable batteries.

Multiple fuse protected outputs: Fuse modules provide protection for 4 or 8 individual circuits.

Dual 12 and 24VDC output capability: 12VDC voltage regulators enable dual 12 and 24VDC output capability for 12 and 24VDC components with one power supply.

Relay and Timer Modules: Relay and timer modules provide interface and control capability for single and multiple stations.

TOUCHLESS EXIT SWITCH

NO TOUCH WAVE-TO-EXIT SWITCH

For Sanitary Entry/Exit applications

DPDT Dry Contact Output • No Moving Parts • Bi-color Status Illumination



Red: Standby
474U
Price - 85



Green: Active
474DU
Price - 140

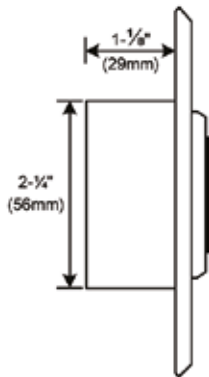

Side View

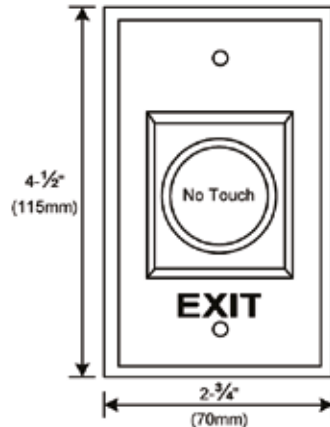

Front View

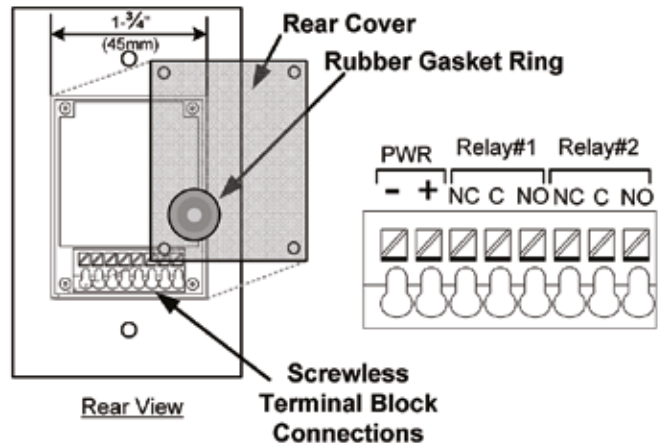

Rear View

Screwless Terminal Block Connections

SPECIFICATIONS

Input: 25mA (standby); 55mA (Active) @ 12/24VDC

Output: 2-SPDT, 3 Amp Dry Contact

Activation Time:

1 second or as long as sensor is triggered

LED Color: Standby RED; Active Green

Range: 4" (10cm)

Weight: 3 oz. (85g)

Dimensions: 4.5" x 2.75" x 1.375"
(115 x 70 x 35mm)

FEATURES & APPLICATIONS

- Uses IR Sensor technology; device is active with the simple wave of a hand
- Designed to control electric locks/strikes, magnetic locks, or automatic door operators
- Ideal for use in sanitary applications such as cleanrooms, bathrooms, food processing, hospitals and labs.
- Sensing Range up to 4" (10cm)
- Mounted on a durable stainless steel plate
- Dual LED, illuminated sensor, Red/Green indicates Inactive/Active status
- Quick connect screwless terminal block for easy installation

Touchless Exit Switch

How To ORDER PANIC DEVICES

CODE	OPTIONS	PRICE
P1	Power Transfer Hinge MPTH - 4	163
P2	Power Transfer hinge MPTH - 10	211
P3	Power Transfer loop MPT-2U	20
P4	Power Transfer Loop MPT-3V	43
P5	Latch Status	87
P6	REX	87
P7	Push Pad Sign	
P8	Keyswitch	87
POWER SUPPLY OPTIONS		
	FB-4 Fused Terminal board 4 individually fused outputs	43
P10	UR2-4 , Universal Controller for 2 doors. Field select TD, LR, TD/LR, mantrap A, B, C interlock. Two fused SPDT dry outputs, 5 Amp @ 30VD	238
P11	UR4-8 Universal Controller for 4 doors. Field select TD, LR, CR, TD/LR, mantrap A, B interlock. Four fused SPDT dry outputs, 5 Amp @ 30VDC. Four SPDT dry outputs, 1 Amp @ 30VDC. Two inputs per station, four auxiliary inputs.	336
P12	PSM Power Supply Monitoring Module For remote monitoring of power supply AC input, DC output and battery backup On/Off status. 2 SPDT Relay Outputs, 1 Amp @ 12/24VDC	238
UR1-V1	Universal Field Programmable Application Module	103
14-2	7 day programmable timer with memory battery back-up capability Output: 1 SPDT, dry contact Voltage: 16 Amps @ 30 VAC/DC Specify 12V AC/DC or 24 AC/DC	276
MRB12V4	12V/5Ah Battery. Specify in pairs for 24V	43
MRB12V7	12V/8Ah Battery Specify 2 for 24V	65
HEAVY DUTY SERIES ECLECTIC POWER TRANSFER DEVICE		
PTM-2AL	Two (2) 18 Ga.Conductor 5 Amp@ 12/24V Ac/Dc Aluminum Powder coated	287
PTM-10Al	Ten (10) 24GA wires 1 Amp @12/24V AC/DCAuminum Powder coated	287

ARCHITECH™ SERIES NETWORK LOCKS

Ideal access control solution; elegantly blending advanced wireless access control convenience within any decor, in attractive, infinitely customizable designer locking form, in choice of trims and finishes.



Features
<ul style="list-style-type: none"> • 5000 Users, 500 Scheduled Events & 40,000 Event Audit Trail • Surface-Mount or Mortised - in Electronics and Battery Pack • Lock available in Mortise and Cylindrical versions • Real Time Clock - Uses 4 AA Batteries – 3 to 4 year battery life • Operated via access card, fob, key fob etc • DL-Windows Software for programming • USB Radio Key Programming Method or Via Network Gateways • Manual Card Enrollment Option for Quick Installation • Wireless programming range: up to 20 ft. from lock
Specifications
<ul style="list-style-type: none"> • ANSI / BHMA Grade 1 Certified, UL Listed 3 Hours • Includes standard lever rose hardware design • Compatible with all 300+ optional architectural trim / lever or knob designs • Stainless steel latch, 2-3/4" backset • Auto-Reverse lock body tested to 6 million cycles • Lock Body - Self cleaning long life motor • Door closure monitor / electronic deadbolt monitor • Key override standard or high-Security • Optional integrated door position indicator switch

PRODUCT	PRICE
Cylindrical	
N90S2195F26D	961
N90S1195F26D	961
Mortise	
N95S2RX92FD26D	1201
N95S1RW86FD26D	1201

Mounted Samples

PRODUCT	PRICE
Cylindrical	
N90S1295SK26D	consult factory
S90S1195SK26D	consult factory
N90S1195SK26D	consult factory
Mortise	
N95S1RW86SK26D	consult factory

ArchiTech™ Series Network Locks Parts and Accessories

PRODUCT	DESCRIPTION	PRICE
AL-IME	Ethernet connected gateway w/AC adapter to plug into standard wall outlet	557
AL-IM80211	Wi-Fi gateway to connect to 802.11 network w/AC adapter to plug into standard wall outlet.	776
AL-IMEPOEP	Power Over Ethernet, plus hardwire gateway interface capability. No AC Power required.	666
AL-IME-USB	USB Gateway	327
AL-NSM	Network Signal Meter	323
ALHID1326	Proximity Access Cards 100 Per Box	551
ALHID1336	Proximity, Magnetic Stripe and Photo ID cards 100 per box	1125
ALHID1386	Proximity and Photo ID Card 100 per box	1012
ALHID1391	MicroProx Tag 10 per box	90
ALHID1346	Proximity keyfob 10 per box	129

ArchiTech Series Network Locks

ARCHITECH™ SERIES NETWORK LOCKS

Standard Model Ordering. Infinite Custom Models available. Call Factory For Ordering Assistance.

Special Order

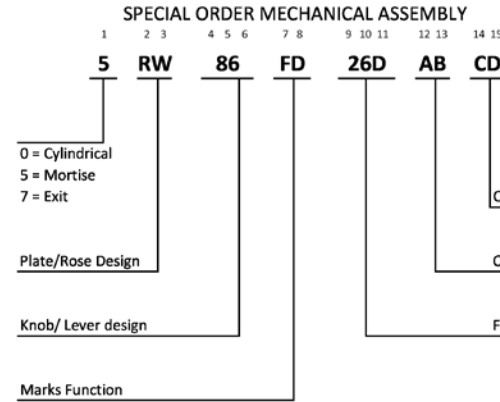
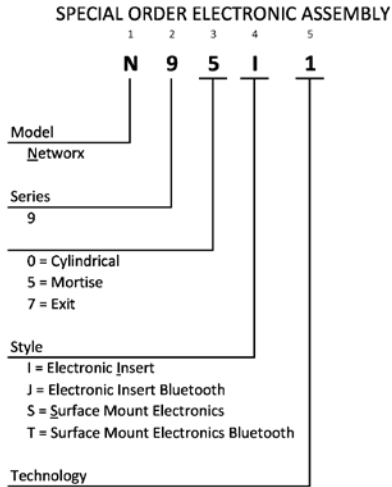

- 1 = Prox Oval
- 2 = Prox Square
- 3 = Mag Stripe Oval
- 4 = Mag Stripe Square
- 5 = Keypad Oval
- 6 = Keypad Square
- 7 = Keypad Prox Oval
- 8 = Keypad Prox Square
- 9 = Keypad Mag Stripe Oval
- 0 = Keypad Mag Stripe Square
- A = Smart Oval (iClass® Technology)
- B = Smart Square (iClass® Technology)
- C = Concealed Prox

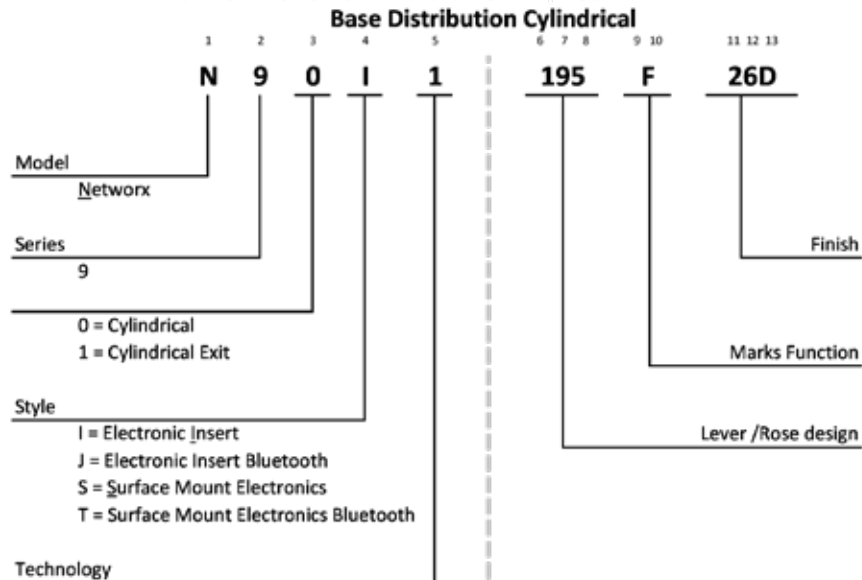
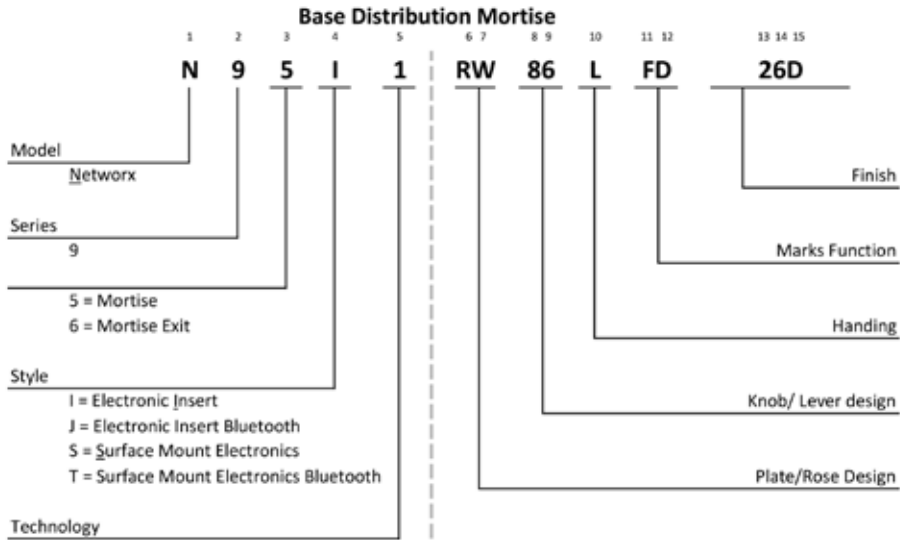

ArchTech Series
Network Locks



MARKS USA

AMITYVILLE, N.Y. 11701

www.marksusa.com

DISTRIBUTED BY:

800-645-9445 • FAX 631-225-6136