

# Kantech IP Link

Enhanced Ethernet Device

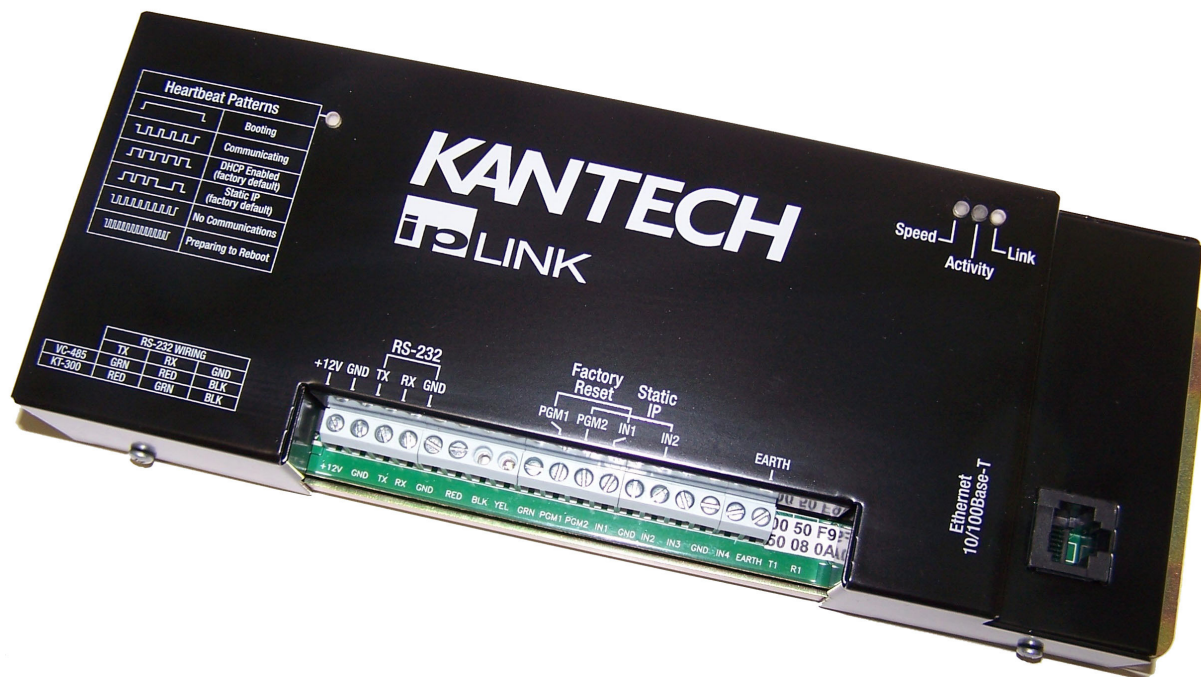

Installation Manual

DN1670-1609

**KANTECH™**

***Tear-out  
Quick Setup Sheet  
on last page!***



Table of Contents

General Information ..... 1  
     Copyright Info ..... 1  
     Technical Support ..... 1  
 Compliance Specifications ..... 2  
     FCC & IC Compliance ..... 2  
     UL 294 Compliance Notice ..... 2  
     Other UL Compliance ..... 2  
     CE & RCM Compliance ..... 2  
     RoHS ..... 2  
     WEEE ..... 2  
 Overview ..... 3  
     Introduction ..... 3  
     Cover Description ..... 4  
     Configurations Options ..... 5  
     Specifications ..... 5  
 Ordering Information ..... 6  
     Models Available ..... 6  
     Installation Manuals ..... 6  
 Site Survey ..... 6  
     Network Topology ..... 6  
         Local Area Network (LAN) ..... 6  
         Wide Area Network (WAN)..... 7  
     LAN Configurations ..... 7  
         Static IP Addressing..... 7  
         Reserved DHCP IP Addressing..... 7  
     WAN Configurations ..... 8  
         Static IP Addressing..... 8  
         Reserved DHCP IP Addressing..... 9  
 Pre-Installation ..... 9  
     Network Configuration ..... 9  
     Equipment Checklist ..... 9  
     ESD Precautions ..... 9  
     Reading Checklist ..... 10  
     Site Checklist ..... 10  
 Task Lists ..... 10  
 Mounting the IP Link ..... 11  
 Connecting the Earth Ground ..... 11  
 Connecting the IP Link to the Controller Loops ..... 12  
 Connecting Power ..... 13  
     For KT-300 Controllers only ..... 13  
     For KT-100 and KT-200 Controllers..... 13  
 Powering Up the IP Link ..... 14  
 Defining the EntraPass Site ..... 14  
 Verifying Communication with the IP Link ..... 17  
 Configuring the IP Link in a WAN/Internet ..... 17  
     Preparing the WAN for the IP Link ..... 17  
     Configuring the IP Link at the Remote Site ..... 18  
     Confirming IP Link Communication with the Gateway ..... 20  
 Configuring the IP Link with the Web Configuration Page ..... 21  
 Upgrading the IP Link Firmware ..... 23  
 How to Reset the IP Link ..... 26



## General Information

**Copyright Info** © 2016 Tyco International Ltd. and its Respective Companies. All Rights Reserved. All specifications were current as of publication date and are subject to change without notice. Kantech and the Kantech logo are trademarks of Tyco International Ltd. and its Respective Companies.

**Technical Support** For technical assistance with the IP Link and other Kantech products, contact technical support, Monday to Friday. See the following table for all technical support phone numbers.

Country/Region	Phone Numbers	Support Hours	Email
<b>North America Toll Free +888 222 1560 (GMT -05:00)</b>			
<b>US and Canada</b>	Direct: +450 444 2030 Fax: +450 444 2029	8:00 to 20:00	kantechsupport@tycoint.com
<b>Latin America (GMT -03:00)</b>			
<b>Argentina</b>	Direct: +5411 4717 2929 Direct: +5411 4717 1320 Direct: +5411 4717 5525 Fax: +5411 4717 1060	9:00 to 18:00	ingenieria@tycoint.com
<b>Asia (GMT +08:00)</b>			
<b>Singapore</b>	Direct: +65 6319 9820 Fax: +65 6319 9821 Direct: +65 6389 8297 Fax: +65 6389 8292	8:30 to 18:00	swhuin@tycoint.com wtooh@tycoint.com
<b>Europe Toll Free +800 CALL TYCO / +800 2255 8926 (GMT +01:00)</b>			
<b>Bahrain</b>	+800 04127	8:00 to 18:00	tfsemea.support@tycoint.com
<b>France</b>	+33 04 72 79 14 83		
<b>Greece</b>	+00 800 31 22 94 53		
<b>Russia</b>	+8 10 800 2052 1031		
<b>Spain</b>	+900 10 19 45		
<b>Turkey</b>	+00 800 31 92 30 37		
<b>United Arab Emirates</b>	+800 0 31 0 7123		
<b>United Kingdom</b>	+44 08701 ADT SUP / 44 08701 238 787 Direct: +31 475 352 722 Fax: +31 475 352 725		

---

## Compliance Specifications

### FCC & IC Compliance

This device complies with Part 15, Class A of the FCC rules. Operation is subject to the following two conditions: (1) this device may not cause harmful interference, and (2) this device must accept any interference received including interference that may cause undesired operation. This class A digital apparatus meets all requirements of the Canadian Interference Causing Equipment Regulations.

---

### UL 294 Compliance Notice

- UL Standard for access control system units.
  - The IP Link is UL 294 listed for supplementary use with EntraPass, KT-300 Controllers, ioProx Proximity readers, and T.Rex request to exit devices.
  - Each IP Link enclosure will be installed in a secured and protected location.
  - Each IP Link will be equipped with an AC powered LED installed outside the IP Link and connected to an inboard relay, and visible at all time to monitor relay status, as per UL 294, section 32.1.5.
  - The KT-IP-PCB has been evaluated by UL for use with the original enclosure and the optional KT-IP-CAB enclosure.
- 

### Other UL Compliance

In order to comply with UL listings, the following has to be respected:

- Use of a UL listed 60950 computer
  - Use only UL listed or recognized cables
  - Use only UL listed or recognized adaptors
- 

### CE & RCM Compliance

EN55022: Information technology equipment, radio disturbance characteristics.

EN55024: Information technology equipment, immunity characteristics.

EN50133-1: Alarm systems - Access control systems for use in security applications: system requirements.

EN61000-6-1: Electromagnetic Compatibility (EMC) - Generic Standards - Immunity for residential, commercial and light-industrial environments.

EN61000-6-2: Electromagnetic Compatibility (EMC) - Generic Standards - Immunity for industrial environments.

---

### RoHS

The RoHS Directive stands for "the restriction of the use of certain hazardous substances in electrical and electronic equipment". This Directive bans the placing on the EU market of new electrical and electronic equipment containing more than agreed levels of lead, cadmium, mercury, hexavalent chromium, polybrominated biphenyl (PBB) and polybrominated diphenyl ether (PBDE) flame retardants.

---

### WEEE

This Directive is for Waste Electrical and Electronic Equipment and addresses the disposal and the environmental handling of these products.

---

Overview

Introduction

The Kantech IP Link makes it easy and affordable to operate your Kantech security system over a network. Unlike other similar devices, the IP Link asynchronously polls the controllers (KT-100, KT-200, KT-300) and communicates with the EntraPass Gateway only when necessary. This significantly reduces the amount of bandwidth required to operate your security system on the network.

The IP Link is essential in determining what to do with specific events and commands. The IP Link directs specific events it receives from any controller to the EntraPass Gateway. On the other hand, it sends commands from the EntraPass Gateway to the appropriate controller.

The IP Link is easy to configure. Use the EntraPass workstation, a web browser or an intuitive stand-alone application called the KT-Finder. The KT-Finder is a small application used to locate an IP Link on a local area network (LAN).

The IP Link is extremely secure. It uses 128-bit AES encryption to communicate with the Gateway which prevents any hacking from the Internet and ensures secure communications when used over the Internet on a wide area network (WAN).

- Secure communication via 128-bit AES encryption
- Minimal bandwidth usage
- Supports up to 32 controllers per IP Link
- Compatible with EntraPass Special Edition, Corporate Edition and Global Edition with Corporate Gateway

**Note:** Kantech recommends a VC-485 for each site. If there is a loss of communication with one of the controllers, the VC-485 will preserve communication with the other controllers.

System Architecture

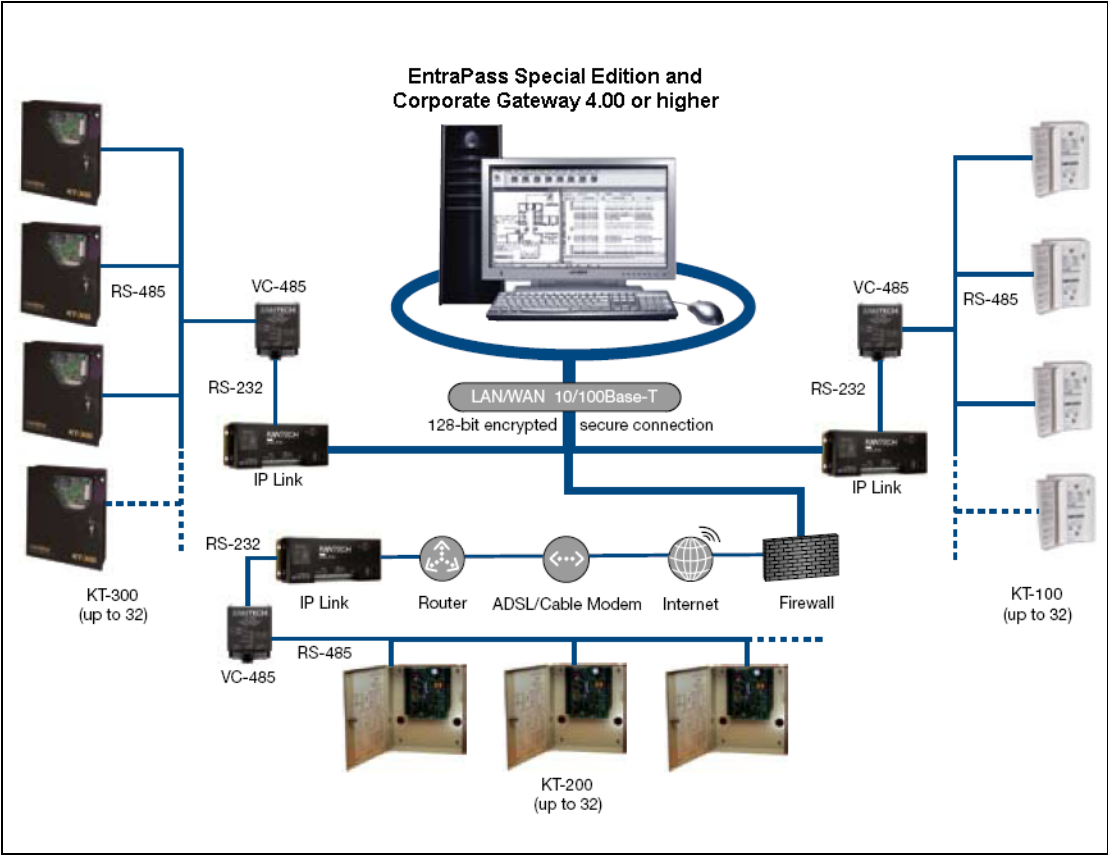

## Cover Description

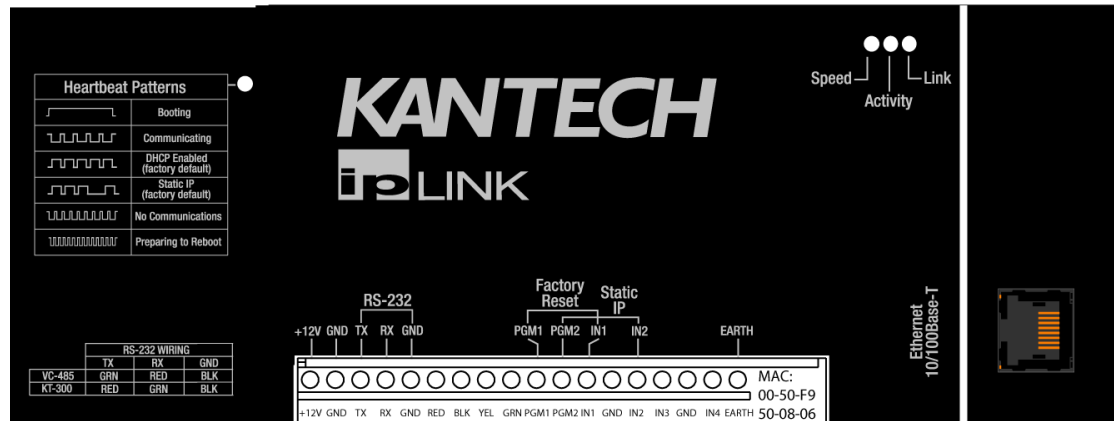

The IP Link has a red status LED called **Heartbeat Patterns** (with cover) or **STAT** (without cover). The main purpose is to indicate if EntraPass is present and if the polling occurs. **Table 1** describes the various heartbeat patterns that are used. See **Table 2** for the description of the other status LEDs.

**Table 1: Status LED Heartbeat Patterns**

Pulses	Description	Patterns
Steady ON for 15 secs	IP Link is booting.	
1 quick flash/sec.	IP Link is configured and communicating with the Gateway.	
1 long flash/sec.	IP Link is in <b>Factory Default (DHCP)</b> mode	
3 flashes in 3 secs and OFF for 1 sec.	IP Link is in <b>Forced Static IP</b> mode (192.168.1.2) and in <b>Factory Default</b> .	
2 quick flashes/sec.	IP Link is no longer communicating with the Gateway but is configured.	
5 quick flashes/sec.	IP Link is preparing to reboot.	
1 long pulse for 2.5 secs	IP Link has received a broadcast from the Gateway or the KT-Finder. After this delay, the IP Link returns to its previous heartbeat pattern. Useful to verify network communication.	



**Table 2: Network status LEDs**

<b>Speed</b>	remains OFF in a 10BaseT network, remains ON in a 100BaseT network.
<b>Activity</b>	blinks to show network activity, and steady when there is intense network activity.
<b>Link</b>	turns ON when the network is present, turns OFF when there is no network.

## Configurations Options

The IP Link can be configured through 3 different options:

- With EntraPass, when the IP Link is within the same local area network (LAN)
- With the KT-Finder application locally through the LAN or remotely through the Internet or wide area network (WAN).
- With a web browser like Internet Explorer locally only (LAN)

## Specifications

**Table 3: Environmental and Electrical Specifications**

Description	Specifications
Operating Temperature	0°C to 49°C (32°F to 122°F)
Humidity Level	0 to 85% non-condensing, indoor use only
DC Power Input	12 VDC
Input current	175 mA

**Table 4: IP Link Specifications**

Description	Specifications
Dimensions	26.7 x 9.5 x 3.12 cm (10.5 x 3.72 x 1.23 in)
Weight	0.6 kg (1.3 lbs)
PCB dimensions	8.30 x 13.30 cm (3.25 x 5.25 in)
Communication Ports	RJ-45 Ethernet 10/100Base-T and RS-232
Communication Speed	Up to 115200 Baud for serial communication
Flash ROM	2 MB
RAM	8 MB

**Table 5: Characteristics with EntraPass**

Description	Specifications
Maximum number of controllers per IP Link	32
Maximum number of sites per Gateway in EntraPass Corporate Edition and Global Edition with Corporate Gateway	512
Maximum number of controllers in EntraPass Special Edition	64

---

## Ordering Information

### Models Available

- **KT-IP:** IP Link PCB with metallic cover and wall plate.
- **KT-IP-PCB:** IP Link PCB and parts.
- **KT-IP-CAB:** Cabinet. Use with **KT-IP-PCB** only.

**Table 6: Bill of Material**

Item Description	KT-IP	KT-IP-PCB	KT-IP-CAB
IP Link PCB with cover and wall plate	1	-	-
IP Link PCB only	-	1	-
Flat cable with RJ-12 male connector, 1.8 m / 6 ft.	1	1	-
Ground wire pack	1	1	1
Nylon standoffs	5	5	-
Light pipes	4	-	-
Taping screws	4	-	-
Installation manual DN1670 - English	1	1	-
Installation manual DN1671 - French	1	1	-
Cabinet	-	-	1

### Installation Manuals

All IP Link manuals are available as free downloads at [www.kantech.com](http://www.kantech.com).

- DN1670 - English
- DN1671 - French
- DN1672 - Spanish
- DN1692 - German
- DN1693 - Italian

### Site Survey

Before starting the installation of the IP Link, you have to determine the configuration that best corresponds to your network architecture. This information is crucial for the proper operation of the Kantech products that you will install. Contact the Network Administrator of the site(s) where you will install the IP Link so that they can provide you with all the network information.

Gather the network information required to configure the IP Link and complete the *Network Configuration Information Sheet* provided at the end of this document.

We have divided this manual so that as soon as you determine the pertaining type of architecture and environment, you can follow the configuration instructions that correspond to your environment before connecting additional components.

### Network Topology

#### Local Area Network (LAN)

A LAN connects network devices over a relatively short distance. A networked office building, school, or home usually contains a single LAN, though sometimes one building will contain a few small LANs, and occasionally a LAN will span a group of nearby buildings.

## Wide Area Network (WAN)

As the term implies, a wide area network spans a large physical distance. A WAN like the Internet spans most of the world. A WAN is a geographically-dispersed collection of LANs. A network device called a router connects LANs to a WAN. In IP networking, the router maintains both a LAN address and a WAN address.

In addition, you will notice that there are two constants in LAN and WAN network topologies:

- Assigning the IP address for communication between the controllers and EntraPass
- Managing both types of IP addresses, static and dynamic

We recommend that you carefully read the following section in order to correctly select the configuration that matches the network architecture where you will install the IP Link.

## LAN Configurations

There are two LAN configurations for the IP Link:

**Note:** Kantech recommends the use of a Static or Reserved DHCP IP address for the IP Link and the Gateway.

### Static IP Addressing

You will use this type of configuration in an environment where the Network Administrator will determine the IP address for communication between EntraPass and the IP Link. We recommend using the EntraPass application to configure the IP Link. The other 2 methods, the KT-Finder and the Web Configuration Page, can be used when the PC has no EntraPass application running.

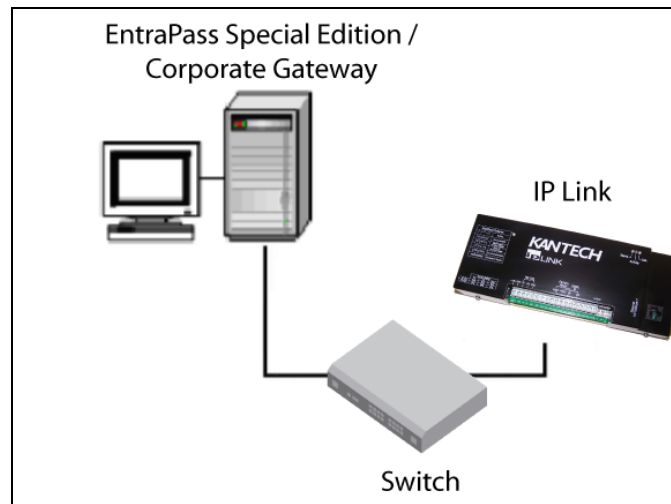

### Reserved DHCP IP Addressing

You will use this type of configuration in an environment where the customer DHCP server assigns the IP address automatically to the IP Link. Additionally, the IP address of the IP Link will have to remain the same, which is called Reserved DHCP. We recommend using the EntraPass application to

configure the IP Link. The other 2 methods, the KT-Finder and the Web Configuration Page, can be used when the PC has no EntraPass application running.

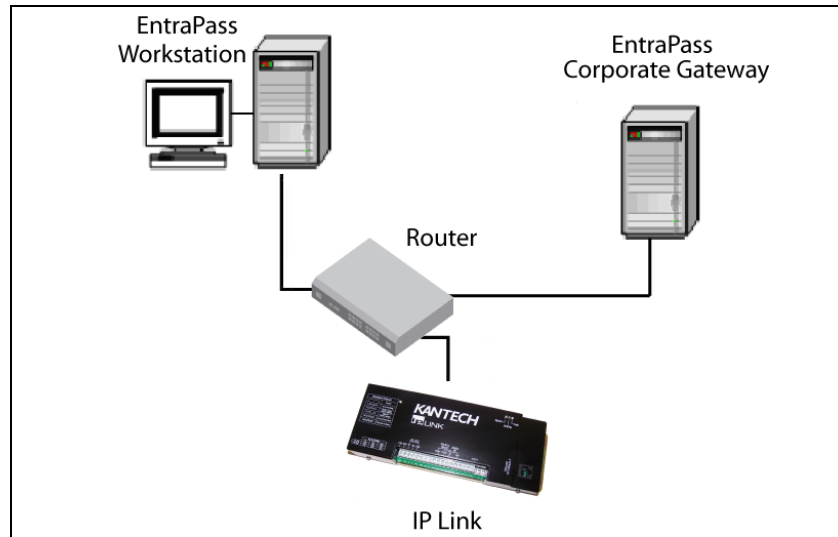

## WAN Configurations

When sites are distant from each other and protected by the router's firewall, the public IP address must be used for communication between EntraPass and the remote IP Link. The Network Administrator must provide you the Public IP addresses (local and remote). The public IP address is provided by the local Internet Service Provider (ISP) which controls the IP address.

**Note:** Kantech recommends the use of a Static or Reserved DHCP IP address for the remote IP Link and the Gateway since the routers must be configured for port forwarding.

There are two WAN configurations for the IP Link:

### Static IP Addressing

You will use this type of addressing in an environment where the Network Administrator will determine the IP address for communication between EntraPass and the IP Link. Since the EntraPass application is at the host site, you must use the KT-Finder to configure the IP Link.

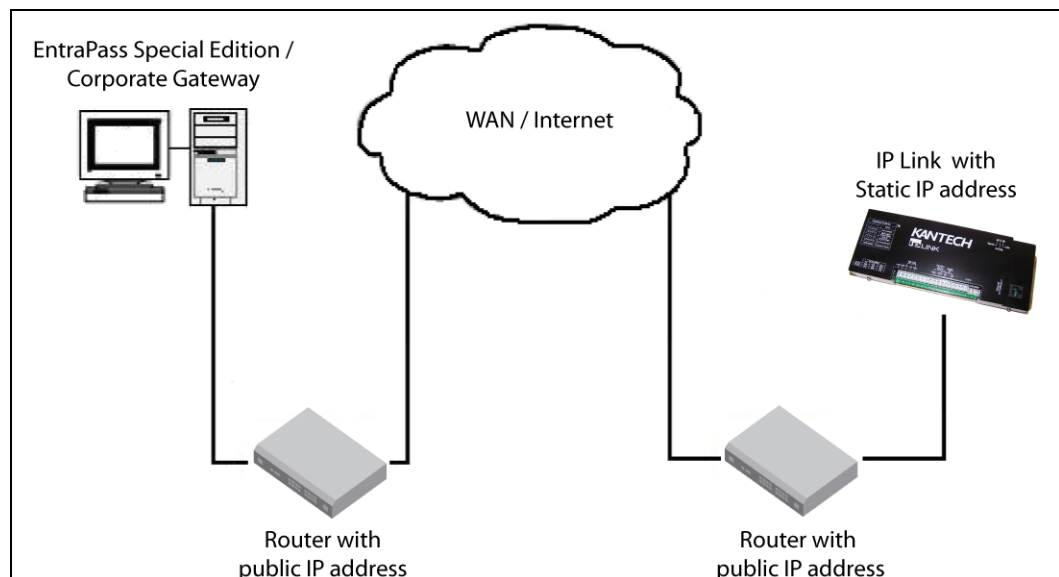

## Reserved DHCP IP Addressing

You will use this type of addressing in an environment where the customer DHCP server assigns the IP address automatically to the IP Link. Since the EntraPass application is at the host site, you must use the KT-Finder to configure the IP Link.

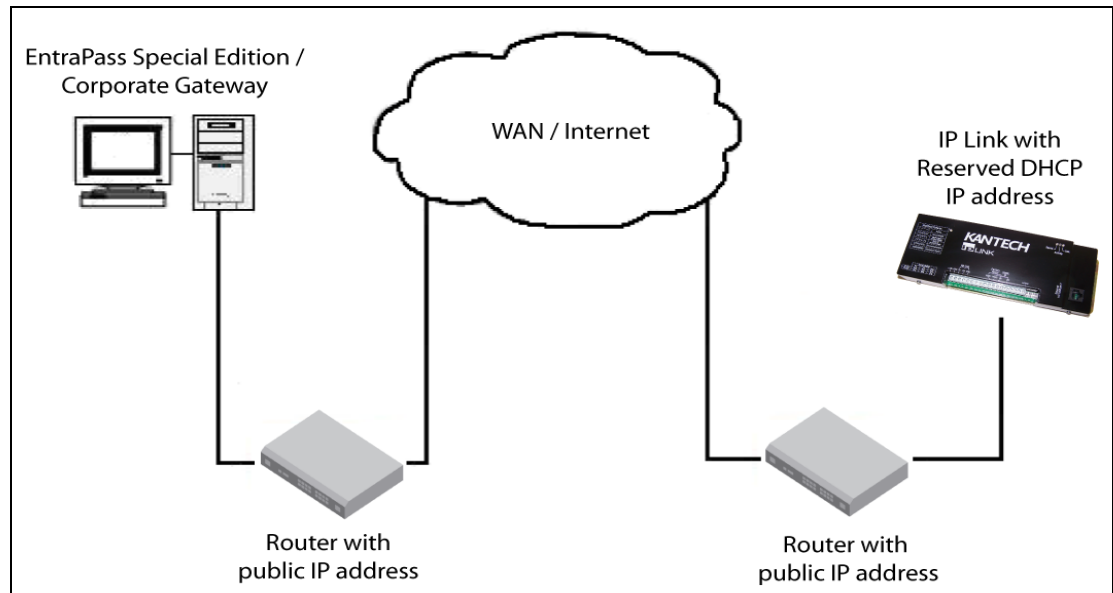

## Pre-Installation

It is important at this stage, if you have not already done so, to contact the Network Administrator where the IP Link will be installed so that you can complete the *Network Configuration Information Sheet*. We suggest that you always have the *Network Configuration Information Sheet* close by, and keep a copy with your IP Link.

Confirm that all parts are in order, all necessary tools are available, and that the site is properly prepared.

If you are connecting your IP Link to EntraPass, you must make sure that you are running EntraPass v4.00 or higher.

---

### Network Configuration

- *Network Configuration Information Sheet* is **fully** completed

---

### Equipment Checklist

- IP Link
- RS-232 cabling
- Installation Manual
- VC-485 (recommended)
- Network cable
- Network crossover cable for direct connection from PC to IP Link

---

### ESD Precautions

ElectroStatic Discharge (ESD) can damage electrostatic sensitive devices. Use antistatic protection to avoid the risk of equipment damage.

---

---

**Reading Checklist**

We strongly suggest that you keep the corresponding EntraPass reference manual close at hand:

- *EntraPass Global Edition Reference Manual*, DN1316
  - *EntraPass Corporate Edition Reference Manual*, DN1415
  - *EntraPass Special Edition Reference Manual*, DN1420
  - *KT-300 Installation Manual*, DN1315
  - *KT-200 Installation Manual*, DN1659
  - *KT-100 Installation Manual*, DN5073
- 

**Site Checklist**

Ensure the following:

- The mounting site is ready.
- The site has been approved and all wiring complies with UL requirements and other codes as appropriate.
- All preliminary site work is completed and the site is clean and free of dust or other contaminants.

## Task Lists

**Table 7** lists the tasks for the configuration of the IP Link in a LAN

**Table 7: Task list for a LAN configuration**

Task	Page
1- Mounting the IP Link	11
2- Connecting the Earth Ground	11
3- Connecting the IP Link to the Controller Loops	12
4- Connecting Power	13
5- Powering Up the IP Link	13
6- Defining the EntraPass Site	14
7- Verifying Communication with the IP Link	17

**Table 8** lists the tasks for the configuration of the IP Link in a WAN

**Table 8: Task list for a WAN configuration**

Task	Page
1- Mounting the IP Link	11
2- Connecting the Earth Ground	11
3- Connecting the IP Link to the Controller Loops	12
4- Connecting Power	13
5- Powering Up the IP Link	13
6- Defining the EntraPass Site	14
8- Configuring the IP Link in a WAN/Internet	17

# 1- Mounting the IP Link

The installation process consists of installing your IP Link and then configuring from EntraPass or the KT-Finder, depending on the network configuration. First mount the IP Link, connect power and grounding connections, then wire the controller loop to the IP Link.

The IP Link does not require any additional enclosures.

- It must be mounted in a secure, yet accessible, location that supports the environmental conditions listed in the environmental specifications. See **Table 3 on page 5**.
- Leave 23 cm (8 in) clearance space around the sides, and at least 33 cm (13 in) space in front.
- Avoid placing the IP Link near electrical or communication devices.
- Install the IP Link on the selected wall using four tapping screws fed through the mounting holes.

### Mounting hole positions

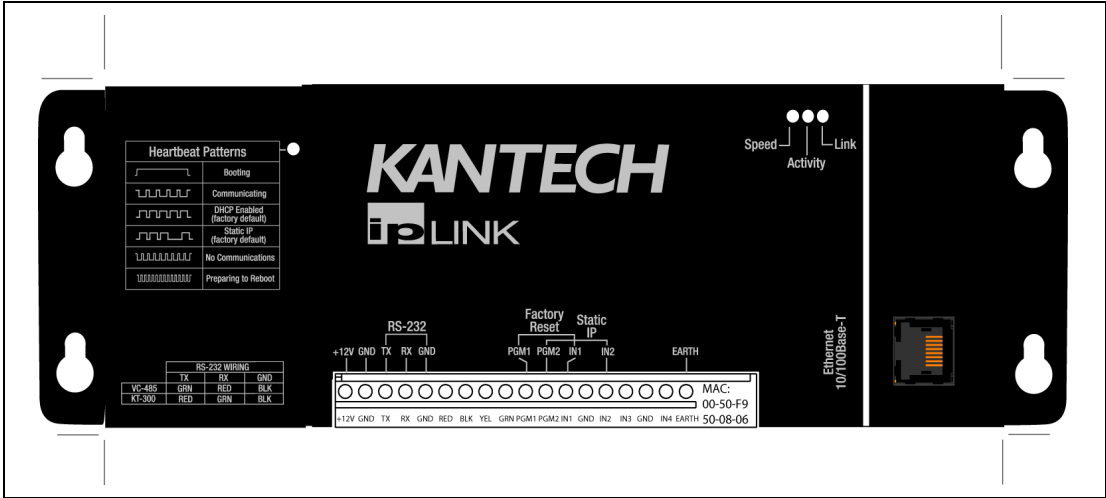

# 2- Connecting the Earth Ground

Connect the provided green ground wire from the EARTH terminal to the cover screw. Use a single conductor solid copper wire to ground the IP Link to a good earth ground as per the local building code.

### Earth grounding

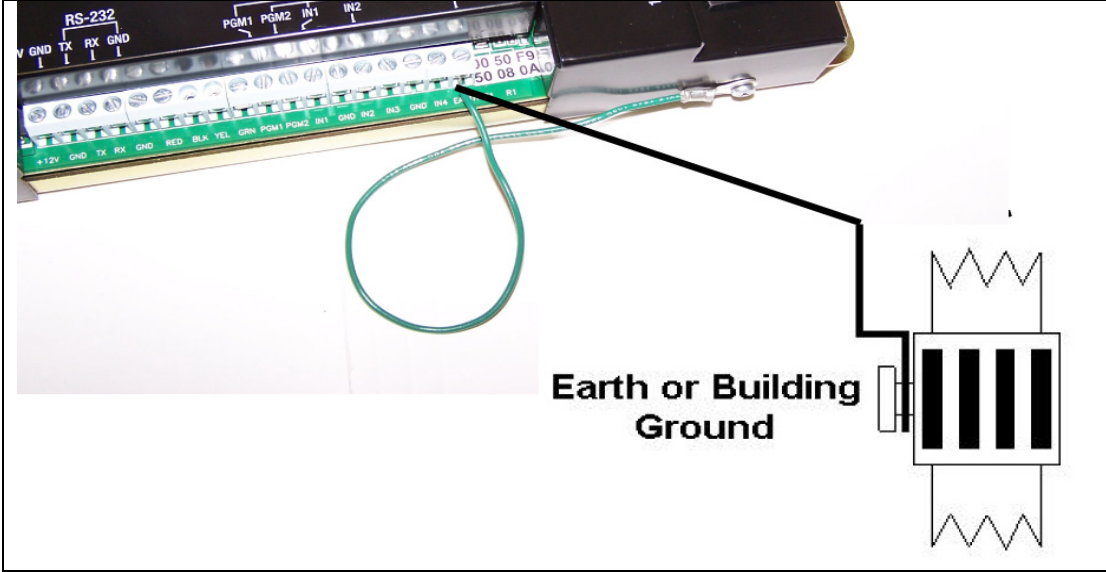

### 3- Connecting the IP Link to the Controller Loops

The IP Link can connect to all Kantech controllers such as the KT-100, KT-200 and the KT-300. The KT-100 only uses RS-485, the KT-200 and KT-300 accept both.

- See **Table 9** and **Figure 1** for RS-232 connection to a VC-485 with RJ12 connector
- See **Table 9** and **Figure 2** for RS-232 connection to a KT-300 with RJ12 connector
- See **Figure 3** for RS-232 connection to a KT-200

**Note:** Always use the same controller model within the same site or loop.

**Table 9: RS-232 Wiring to IP Link**

RJ12 connector on	TX	RX	GND
VC-485	GRN	RED	BLK
KT-300	RED	GRN	BLK

**Figure 1: RS-232 connection with RJ12 to VC-485 (KT-100, KT-200 and KT-300)**

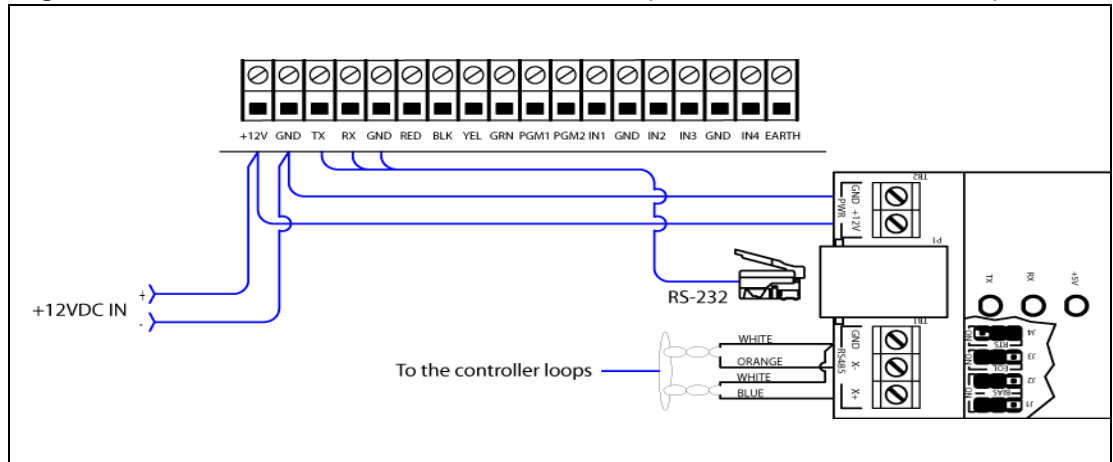

**Figure 2: RS-232 connection with RJ12 to KT-300 #1 (only with KT-300)**

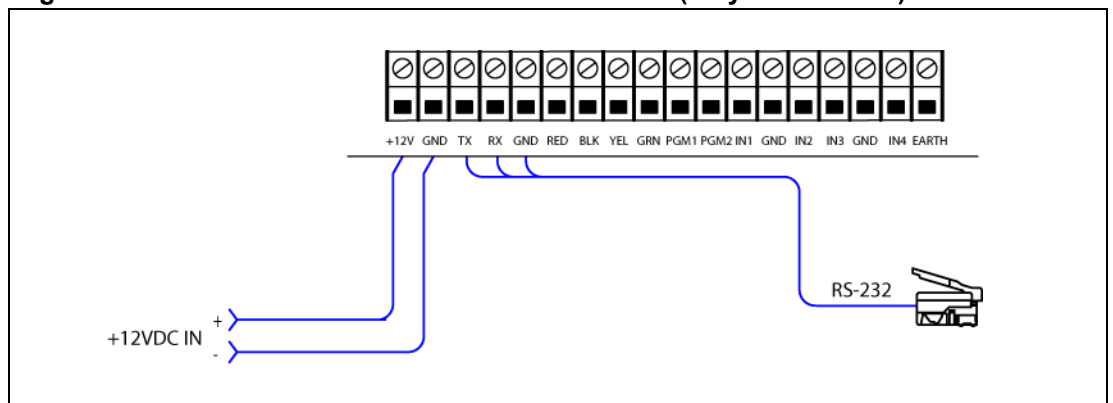
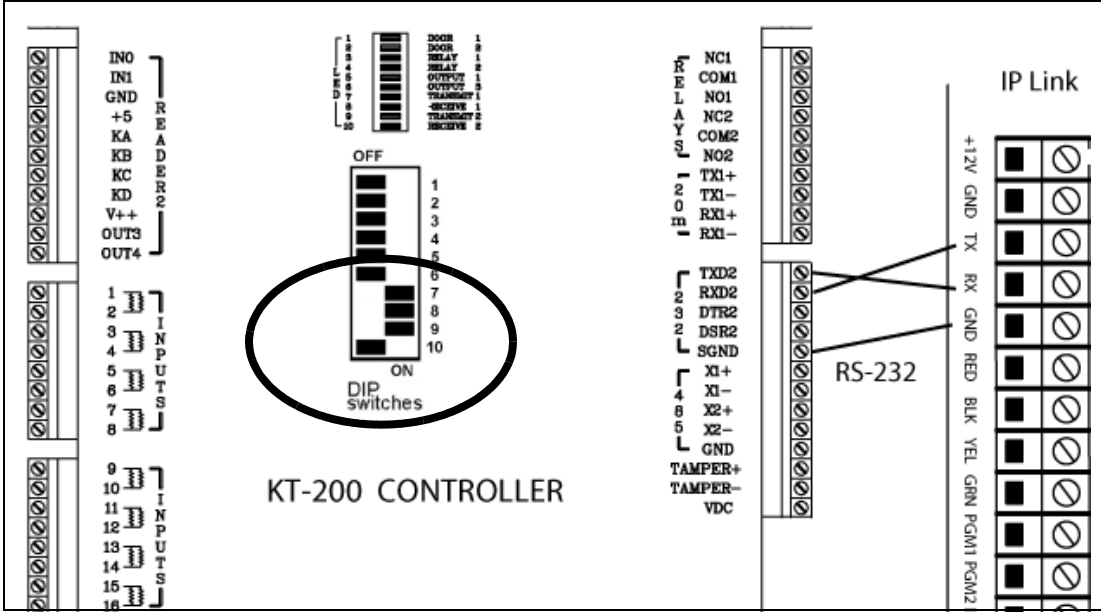



Figure 3: RS-232 connection to KT-200 #1



4- Connecting Power

For KT-300 Controllers only

- Use the 12V DC from the 12V AUX terminals.

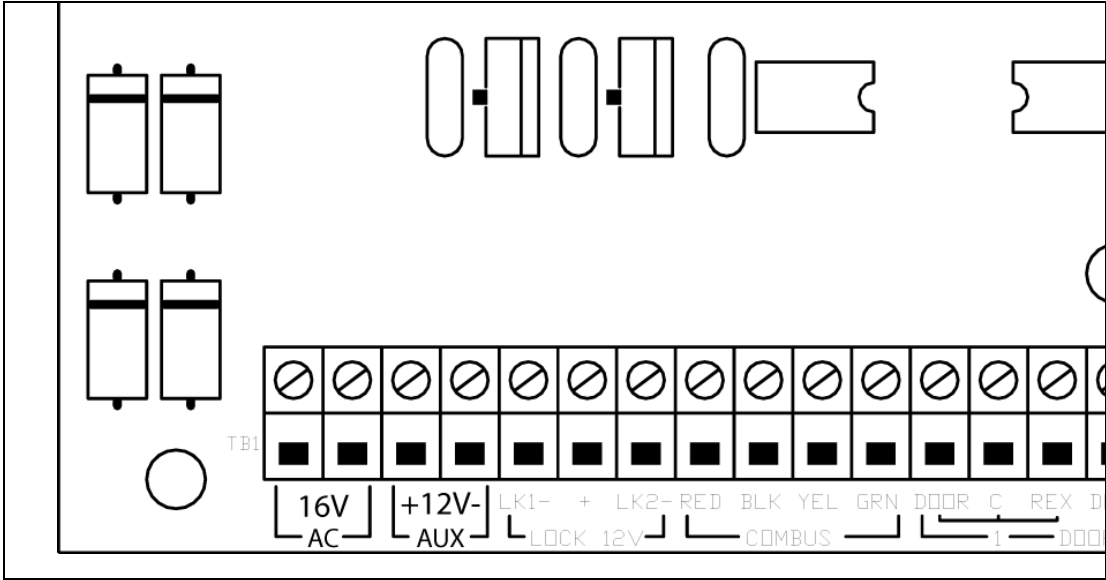

For KT-100 and KT-200 Controllers

- You will need a separate 12V DC power supply with battery backup for the IP Link.

---

## 5- Powering Up the IP Link

1. Power up the IP Link.
2. Make sure the IP Link is in **Factory Default (DHCP)** mode before starting the configuration. See **Table 1 on page 4** for the heartbeat patterns per state.
3. Connect the network cable.

## 6- Defining the EntraPass Site

**Before you start** These items must be completed and verified:

- The detachable *Network Configuration Information Sheet* is fully completed.
- You are running EntraPass version 4.03 or higher.

**Note:** If you are running EntraPass Corporate Edition or EntraPass Global Edition; the following system components should have been installed and configured:

- an EntraPass Workstation,
- an EntraPass Corporate Gateway.

The IP Link communicates locally with EntraPass through a 10/100 Base-T Ethernet connection.

1. From the **Devices** menu, go to **Site**, or click on **Devices > Site**.
2. Click on **New**, located in the top left corner of the Site/Loop screen, to create a new site.

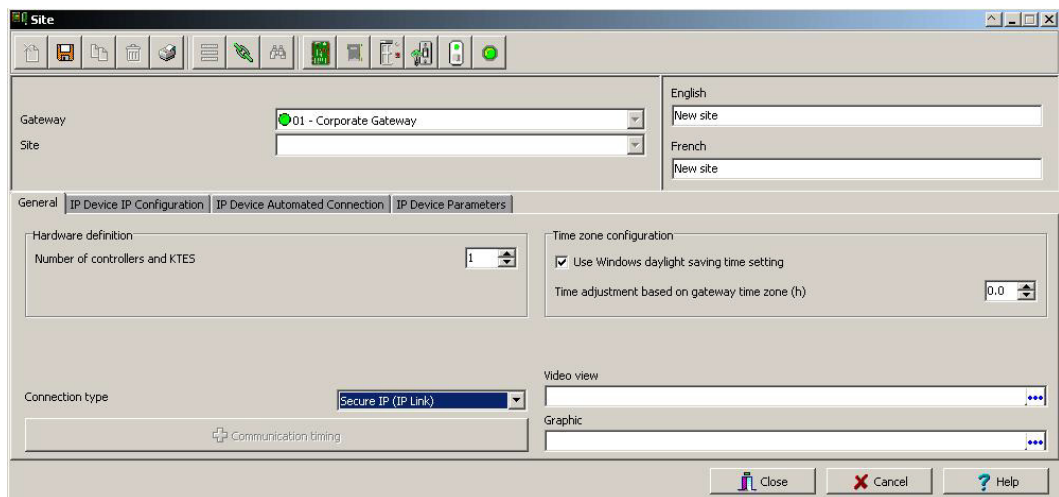

3. Enter the site name for both languages.
4. Under the **General** tab, select **Secure IP (IP Link)** from the **Connection type** menu.
5. Enter the **Number of controllers**.  
**Note:** The maximum number of controllers per IP Link is 32.
6. Complete the other settings as required.
7. Click on the **IP Device IP Configuration** tab.
8. Look on the IP Link for the MAC address sticker next to the terminal strip and complete the **MAC address** of the IP Link.  
**Note:** The 1st 6 digits are already displayed and can't be modified: **00:50:F9:00:00:00**.
9. Make sure the **Online** option is checked.
10. Enter the required information as specified in the *Network Configuration Information Sheet*.
  - For a Static IP address, click **Use the following IP address** and enter the information.

- For a Reserved DHCP IP address, click **Obtain an IP address automatically**.

## Example when obtaining an IP address automatically

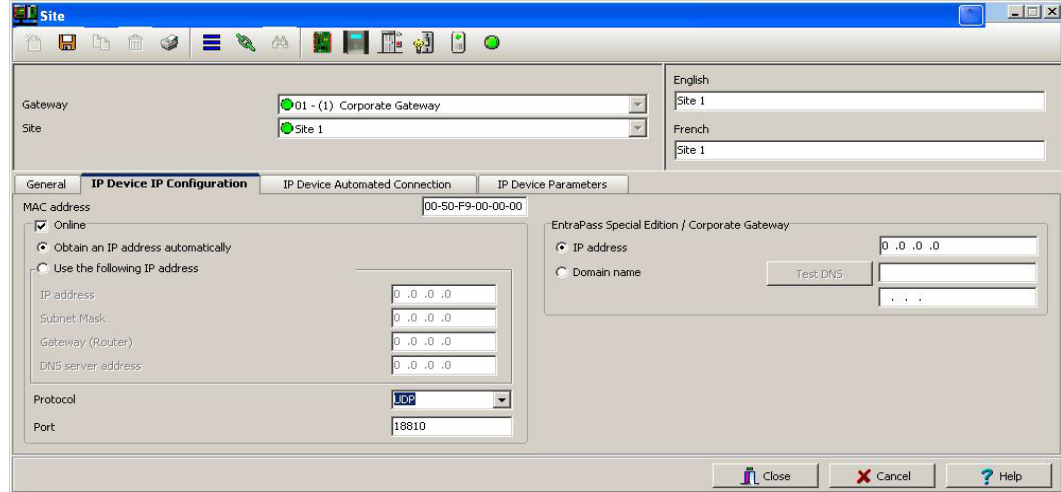

11. Enter the **IP address** or the **Domain name** of the **Entrapass Special Edition / Corporate Gateway**.
12. Select a **Protocol (UDP or TCP)** from the dropdown list.
13. Enter a port number.
  - For **TCP**: No port required.
  - For **UDP**: Enter the **Port** number used by the IP Link (port 18810 by default). If more than one IP Link resides at the same IP address (WAN/Internet applications) then it will require the use of a unique port number per IP Link. See **Procedure 8 on page 17**.
14. Click on the **IP Device Automated Connection** tab.
15. Make sure the **Broadcast configuration** option is checked for LAN configuration.

**Note:** Leave the option **Enable KT-Finder diagnostic for IP device** checked, to be able to view and troubleshoot the IP Device configuration with the KT-Finder.

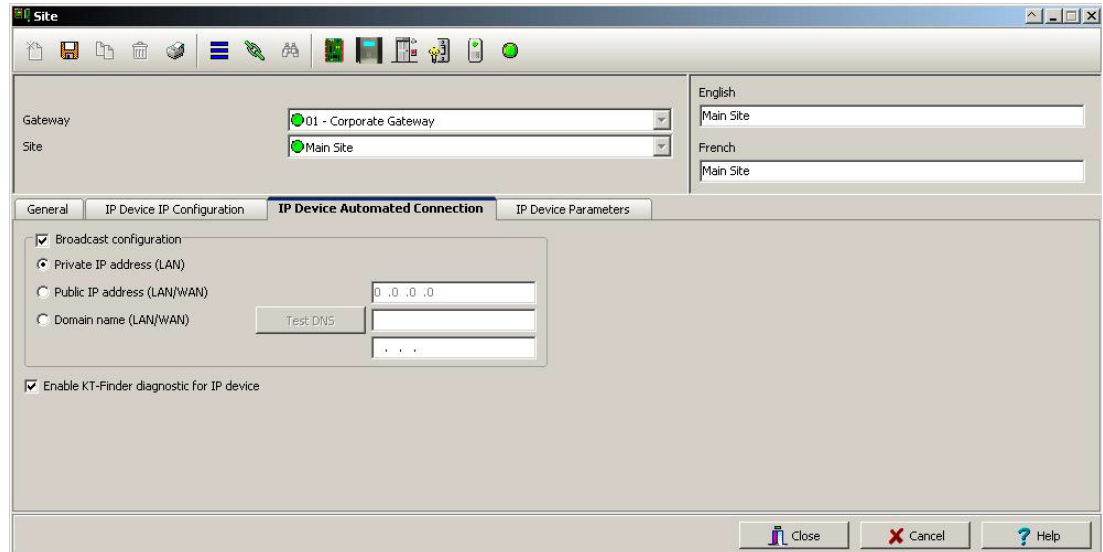

**Note:** To configure the system using a public IP address (LAN/WAN), please refer to **Configuring the IP Link at the Remote Site on page 18** for more details.

16. Click on the **IP Device Parameters** tab.

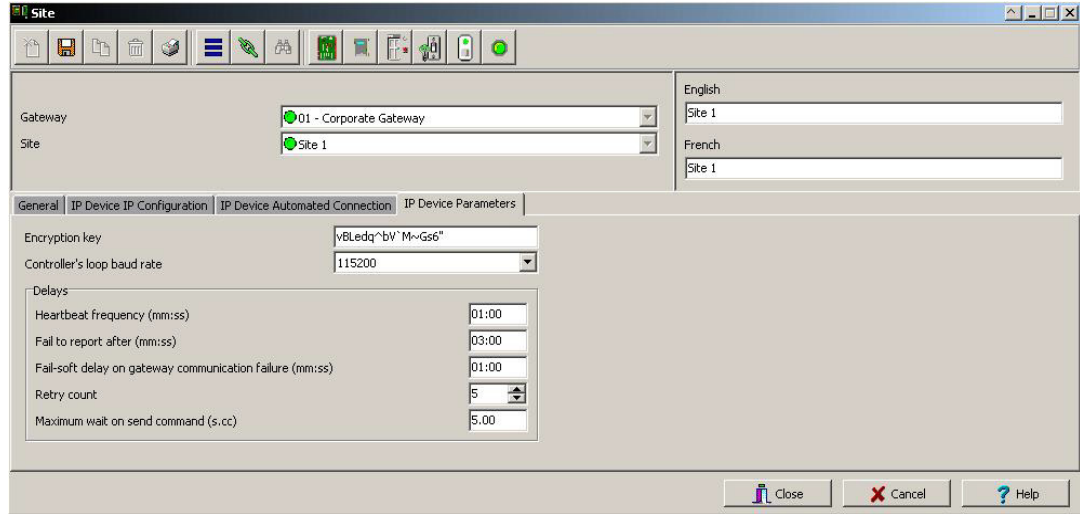

17. Verify the **Encryption key**. A random key is generated automatically.

18. Select the **Controller's loop baud rate**.

**Note:** The maximum baud rate for the KT-200 controller is 19200.

19. The settings in the **Delays** section refer to the communication with the Gateway. In order to display the connection status of the IP Link with EntraPass and to avoid large amount of traffic, the IP Link sends a heartbeat to EntraPass at a pre-configured interval (60 seconds for example). If EntraPass is not answering after this amount of time, the IP Link will retry several times and then stop the polling if no answer is received.

- **Heartbeat frequency (mm:ss):** The time range value is from 0:15 to 10:00. This is the heartbeat frequency from the IP Link to the Gateway.
- **Fail to report after (mm:ss):** The time range value is from 3:00 to 59:59. This is the time that the Gateway will wait before declaring IP Link communication failed.

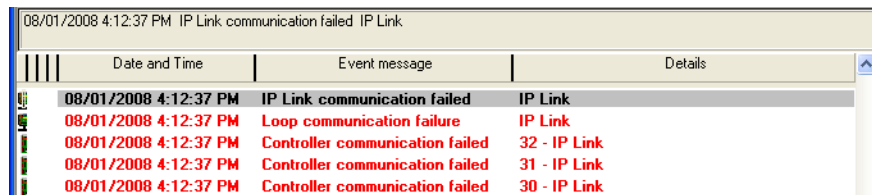

- **Fail-soft delay on gateway communication failure (mm:ss):** The maximum time range value will follow the selection from the Heartbeat Frequency. This is the time that the IP Link will take to verify if there is a communication failure with the Gateway before it operates in stand-alone mode.
- **Retry count:** The range value is 1 to 15. This is the number of times that the IP Link will retry to confirm communication failure with the Gateway.
- **Maximum wait on send command (s:cc):** The time range value is from 1:00 to 9:99. This is the maximum time allowed for the IP Link to acknowledge a command sent from the EntraPass workstation.

20. Click on the floppy icon to save. Click on **Close**.

## 7- Verifying Communication with the IP Link

If the IP Link is within the	then go to
local DHCP server (LAN)	<b>Step 1.</b>
remote DHCP server (WAN)	<b>Procedure 8 on page 17.</b>

1. Verify the communication status between the new IP Link and the Gateway. From the EntraPass workstation **Operation** menu, select **Site**.

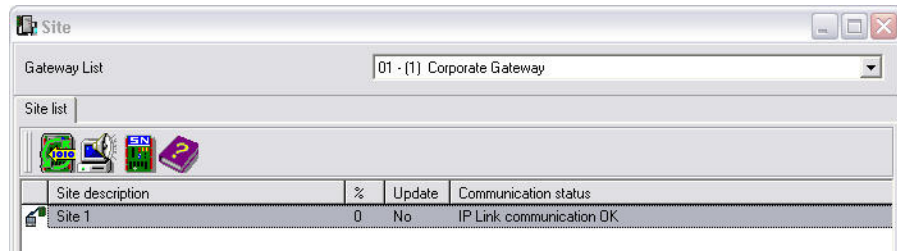

2. Select the Gateway from the **Gateway List**.

**Note:** For the EntraPass Special Edition application, there is no **Gateway List** selection.

The **Communication status** must read as follows: **IP Link communication OK**.

**If the communication status does not indicate IP Link communication OK, check the descriptions for the other messages:**

- **Broadcast IP Link succeeded waiting for heartbeat:** Broadcast confirmation to IP Link.
- **IP Link communication unknown:** The IP Link is starting up.
- **IP Link communication failed:** The IP Link has failed to report to the Gateway.
- **Failed to reach IP Link:** The Gateway is not receiving the IP Link confirmation.
  - Check if network cable is connected to RJ-45 connector on IP Link.

## 8- Configuring the IP Link in a WAN/Internet

### Preparing the WAN for the IP Link

When using the IP Link in a WAN configuration behind a router/firewall, it is necessary to forward port(s) for both the local (Gateway) and the remote (IP Link) sites. Typically, this will be performed by the Network Administrator.

**UDP:**

1. Ports used at the Corporate Gateway location: Forward ports 18001 and 18801 to the IP address of the Gateway.

**Table 10: Gateway Ports**

Purpose	Port
Firmware upgrade	18001
Communication with IP Link	18801

- 
- Ports used at the remote site (IP Link): Forward port 18810 to the IP address of the IP Link.

**Table 11: IP Link Ports**

Purpose	Port
Broadcast and KT-Finder	18803
Communication with the Gateway	18810 ( <b>Note 1</b> )
Web Configuration Page	80 ( <b>Note 2</b> )

**Note 1:** If you are using more than one IP Link at the same remote site, it is necessary to use a unique port number for each IP Link. This information is used in **Procedure 6, Step •**

**Note 2:** This port is used to configure the IP Link with a Web Browser and should not be forwarded. This will restrict its use to the LAN only.

**TCP:**

- Ports used at the Corporate Gateway location:

**Table 12: Gateway Ports**

Purpose	Port
Firmware upgrade	18802
Communication with IP Link	18802

## Configuring the IP Link at the Remote Site

The KT-Finder is an application used to configure the IP Link over the local area network (LAN) or the wide area network (WAN).

**Important:** The KT-Finder application is on the EntraPass CD-ROM and is also available as a free download from [www.kantech.com](http://www.kantech.com). It doesn't require any installation.

- Quit all EntraPass applications.
- Make sure there is a DHCP server on site and the IP Link is in **Factory Default (DHCP)** mode. See **Table 1 on page 4**.
- Start the KT-Finder.

**Note:** If you try to run the KT-Finder while running EntraPass, you will get an error message similar to this.

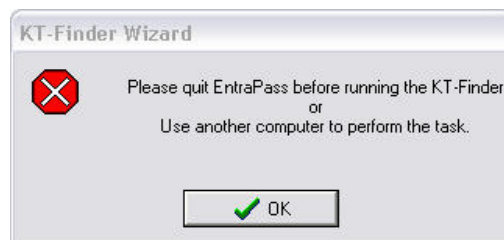

- Select **IP Link** from the **Device** menu.

5. Enter the **MAC address** of the IP Link then click on **Connect**.



6. When the IP Link is found, the configuration page will display.



7. Verify your *Network Configuration Information Sheet*:
  - Enter the **EntraPass IP address** or the **Domain name** of the **EntraPass Special Edition / Corporate Gateway**. This information must be the same as entered in **Procedure 6 Step 11**.
  - Select **Obtain an IP address automatically** or **Use the following IP address** but it must be the same as entered in **Procedure 6 Step 10**.

- 
8. Select the **Protocol (UDP or TCP)**
  9. Change the **Port** number, if required.  
**Note:** The port number should only be changed when you have more than one IP Link at the same remote site.
  10. Click **OK**.
  11. Repeat the procedure for each IP Link at this site.

## Confirming IP Link Communication with the Gateway

The IP Link should begin communicating with the Gateway within a few minutes. To confirm that they are communicating, please verify the following:

12. Verify that the IP Link heartbeat pattern LED is flashing 1 quick flash/sec. as per **Table 1 on page 4**.
13. Verify communication between the new IP Link and the Gateway. From the EntraPass workstation **Operation** menu, select **Site** and then select the Gateway from the **Gateway List**.

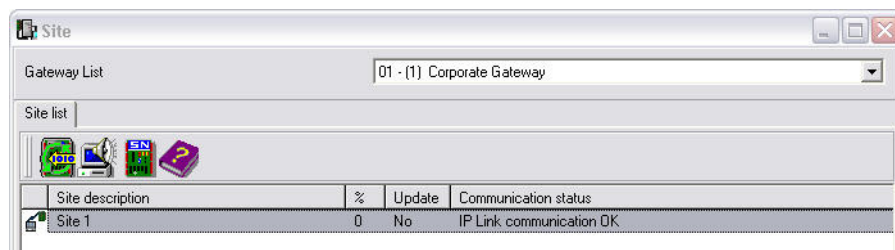

**Note:** For the EntraPass Special Edition application, there is no **Gateway List** selection.

The **Communication status** must read as follows: **IP Link communication OK**.

**If the communication status does not indicate IP Link communication OK, check the descriptions for the other messages:**

- **IP Link communication unknown:** The IP Link is starting up.
- **IP Link communication failed:** The IP Link has failed to report to the Gateway.
- **Failed to reach IP Link:** The Gateway is not receiving the IP Link confirmation through the communication port 18801.
  - Check if network cable is connected to RJ-45 connector on IP Link.
  - Verify configuration port number if there are more than one IP Link at the remote site.
  - Verify port forwarding assignments at both sites, see **Table 10 on page 17** and **Table 11 on page 18**.
  - Validate the addresses (IP or DNS) of the Gateway in EntraPass and the IP Link.



## Configuring the IP Link with the Web Configuration Page

This procedure is practical if you want to configure the IP Link(s) in advance before going on site.

**Note:** The Web Configuration Page is available only while the IP Link is in **Forced Static IP**.

**Before you start**

- The detachable *Network Configuration Information Sheet* is fully completed.
- Determine your connection to the IP Link and choose the appropriate network cable that you need. See below for an example with each type of network cable.

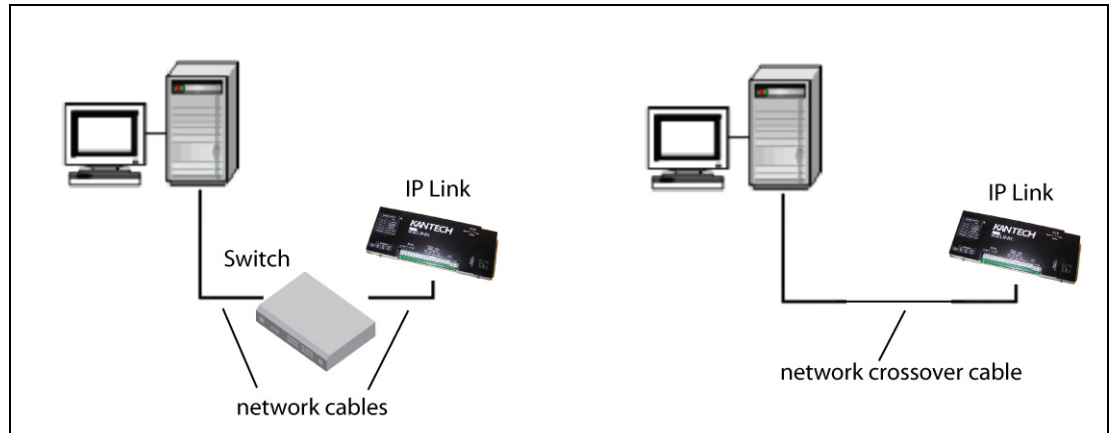

1. Make sure the IP Link is in **Forced Static IP** before starting the configuration. Verify the heartbeat patterns to determine the status, see **Table 1 on page 4** and **Table 13 on page 26** to put the IP Link in **Forced Static IP**.
2. At your computer, change your network connection settings as follows.

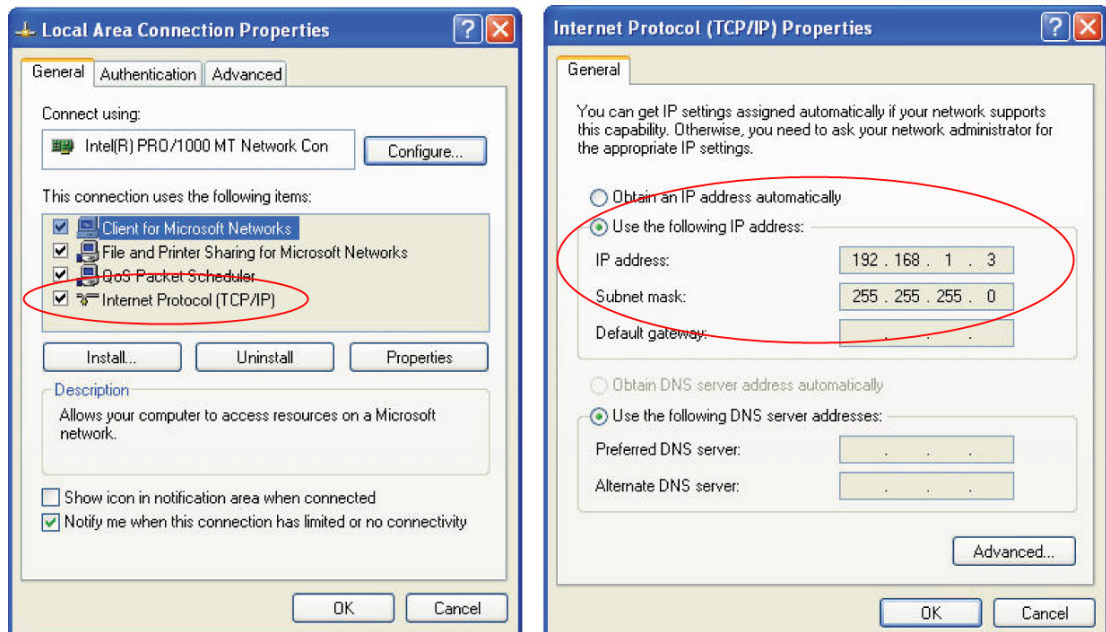

3. Start your web browser and enter the following IP: 192.168.1.2 and press **Enter**.

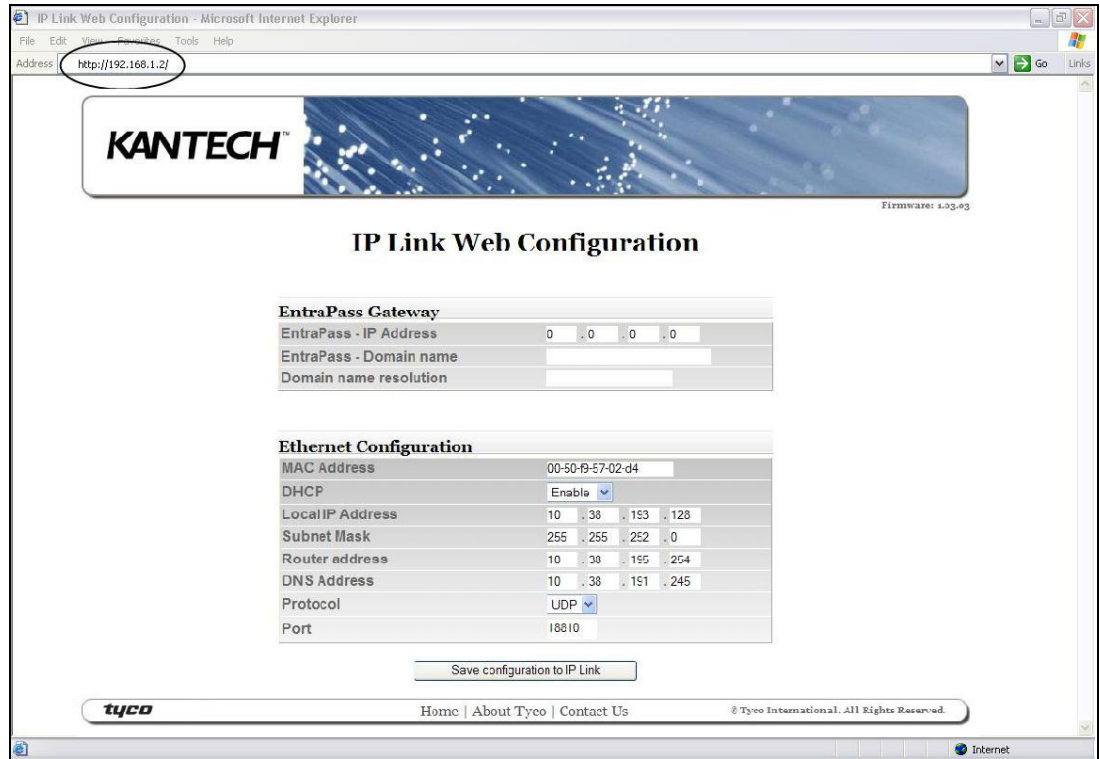

4. Enter the IP addresses as per the *Network Configuration Information Sheet* but do not click on the **Save configuration to IP Link** button yet.
5. Remove the wire between PGM2 and IN2 on the IP Link.
6. Click on the **Save configuration to IP Link** button.

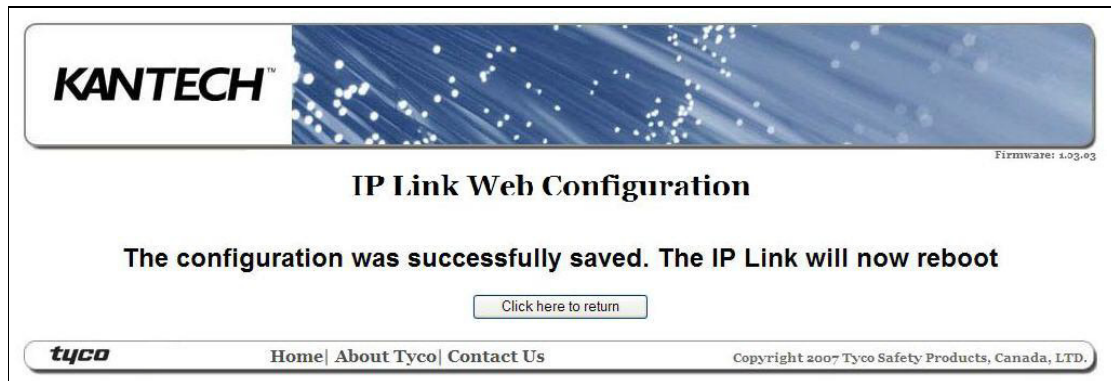

7. When you will go to the site with the configured IP Link, you will have to enter the same details into the EntraPass workstation.

## Upgrading the IP Link Firmware

**Warning:** You will lose communication with all your controllers for **up to 5 minutes** during this upgrade. This must be planned accordingly.

1. Verify the communication status between the IP Link and the Gateway. From the EntraPass workstation **Operation** menu, select **Site**.

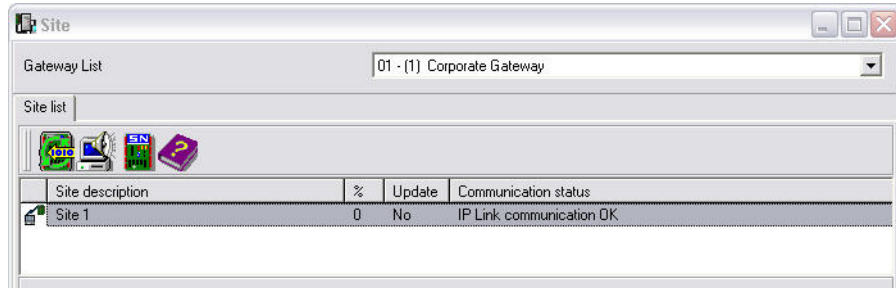

2. Select the Gateway from the **Gateway List**.

**Note:** For the EntraPass Special Edition application, there is no **Gateway List** selection.

The **Communication status** must read as follows: **IP Link communication OK**.

3. Confirm the firmware version before proceeding. Right click on the site name to view the contextual menu.

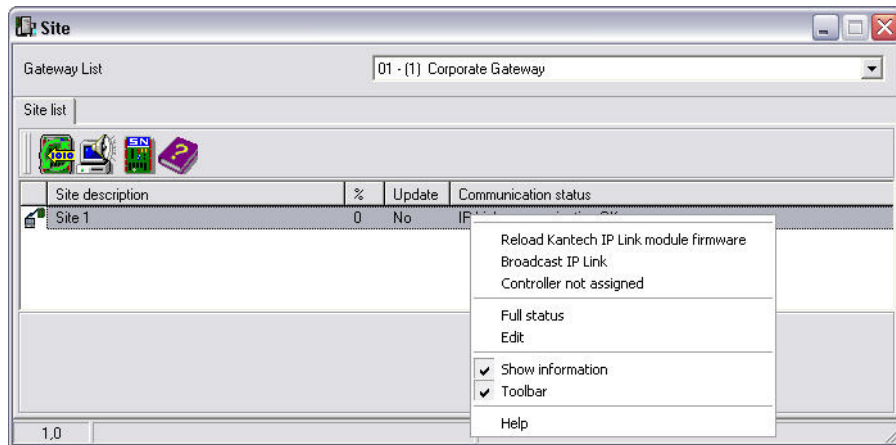

4. Select **Full status** to view the firmware version.

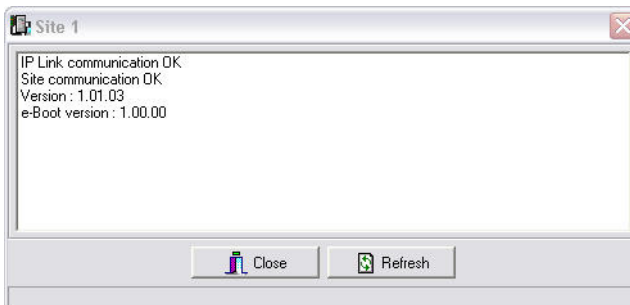

5. Click **Close**.

- From the **Options** menu, select **System Parameters**.

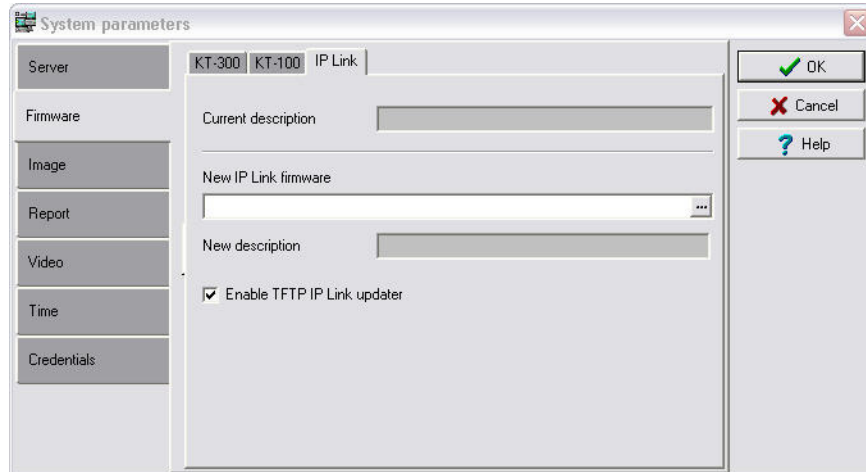

- From the **Firmware** section, click on the **IP Link** tab.
- Make sure the **Enable TFTP IP Link updater** option is checked.
- Click on the 3 dots to locate the firmware file.
- Select the firmware file and click **OK**.
- Click **OK** to close the **System Parameters** dialog.
- From the **Operation** menu, select **Site**.
- Select the Gateway from the **Gateway List**.

**Note:** For the EntraPass Special Edition application, there is no **Gateway List** selection.

- Click on the site that corresponds to the IP Link to highlight it.
- Click on the reload firmware button.

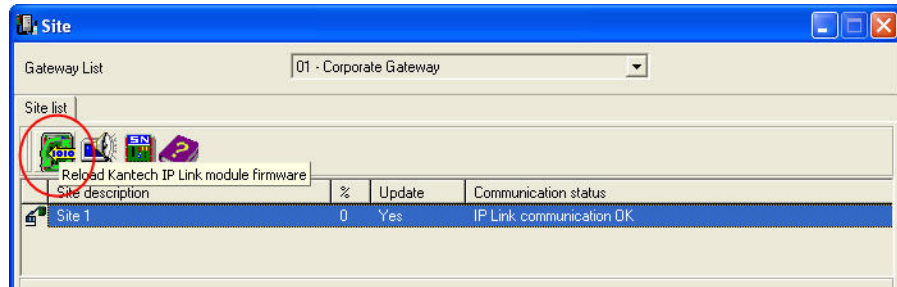

- A confirmation will display.



- Click **Yes**.
- The IP Link will reset and restart with the new firmware.

**Warning:** That process could take up to 5 minutes.

The communication status in the **Operation > Site** will say **IP Link Communication Failed** then back to **IP Link Communication OK**.

19. Right click on the site name to view the contextual menu.

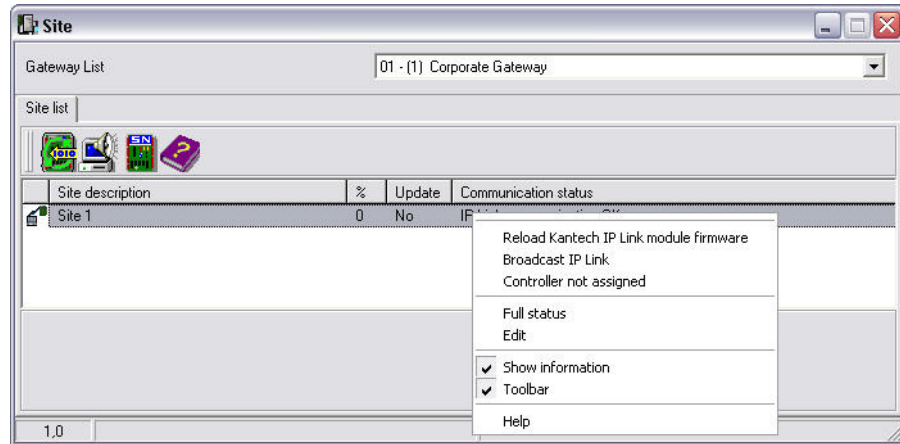

20. Select **Full status** to view the new firmware version.

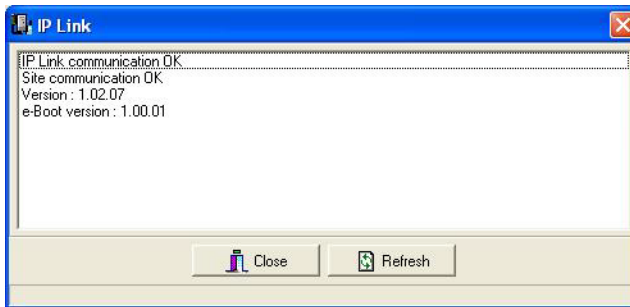

21. Two very important status messages must be listed as well:

- IP Link communication OK for IP Link communication status with the Gateway.
- Site communication OK for controllers communication, through the IP Link, with the Gateway.

22. Click **Close**.

## How to Reset the IP Link

For maintenance or configuration purposes, the IP Link can be reset. Two types of resets can be performed: **Factory Default (DHCP)** and **Forced Static IP**.

**Table 13: Reset options**

Resets	Instructions
Factory Default (DHCP)	<p><b>WARNING:</b> This reset will clear all IP Link configuration including the IP address.</p> <ol style="list-style-type: none"> <li>1. Disconnect DC power.</li> <li>2. Connect a wire between the PGM1 and IN1 pins. <b>There should be no wire between PGM2 and IN2.</b></li> <li>3. Connect power.</li> <li>4. Wait 60 secs. The Heartbeat Patterns or STAT LED should be steady red, then blink very quickly.</li> <li>5. Remove the wire between PGM1 and IN1.</li> <li>6. See <b>Table 1 on page 4</b> for the heartbeat patterns: 1 long flash per sec.</li> <li>7. The IP Link will now be in DHCP mode and will attempt to obtain an IP address automatically from the DHCP server.</li> </ol>
Forced Static IP (192.168.1.2) and Factory Default	<p><b>WARNING:</b> This reset will clear all IP Link configuration and temporarily assign 192.168.1.2 as an IP address so that the IP Link may be configured using a Web Browser or the KT-Finder.</p> <ol style="list-style-type: none"> <li>1. Disconnect DC power.</li> <li>2. Connect a wire between the PGM1 and IN1 pins.</li> <li>3. Connect a wire between the PGM2 and IN2 pins.</li> <li>4. Connect DC power.</li> <li>5. Wait 60 secs. The Heartbeat Patterns or STAT LED should be steady red, then blink very quickly.</li> <li>6. Remove <b>only</b> the wire between PGM1 and IN1.</li> <li>7. See <b>Table 1 on page 4</b> for the heartbeat patterns: 3 flashes in 3 secs and OFF for 1 sec.</li> <li>8. The IP Link will now be accessible at IP address 192.168.1.2. Connect to the IP Link using either the KT-Finder or the Web Configuration Page.</li> <li>9. Remove the wire between PGM2 and IN2.</li> <li>10. After doing the configuration, save and wait at least 1 minute to let the IP Link restart.</li> </ol>

**Figure 4: Terminal positions for resets**

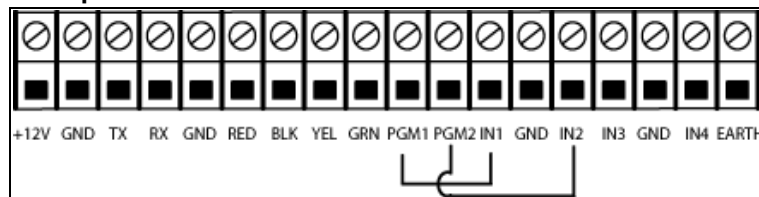

---





# Kantech IP Link Quick Setup Sheet

- From EntraPass v4.0 and higher, go to **Devices > Site**. Select an existing **Gateway** and **Site** or create a new site.

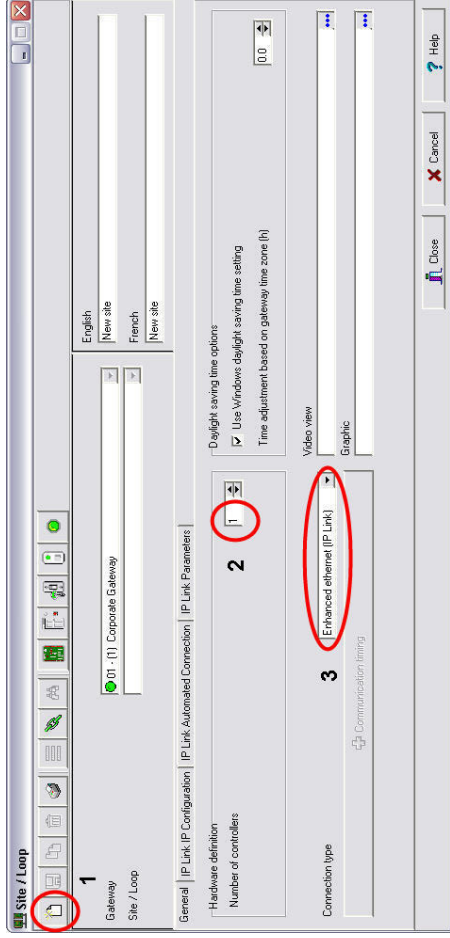

- Enter the **Number of controllers**.
- Choose **Enhanced Ethernet (IP Link)** as connection type. Move to the **IP Link IP Configuration** tab.
- Enter the **IP Link MAC** address.

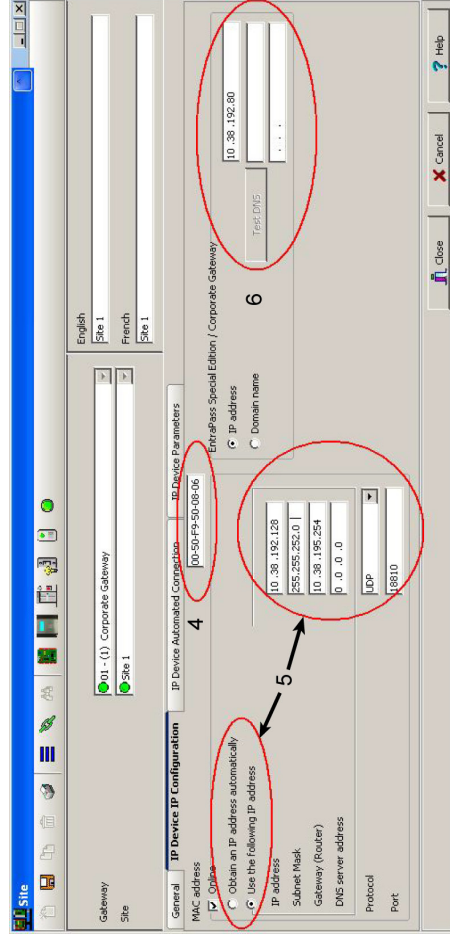

- Choose **Obtain the IP address automatically** or **Use the following IP address**.
- Enter the **IP address** (or **Domain name**) of the PC on which **EntraPass Special Edition/Corporate Gateway** is installed. Move to the **IP Link Automated Connection** tab.

- The parameters you will define in this section depends on the type of installation you have:

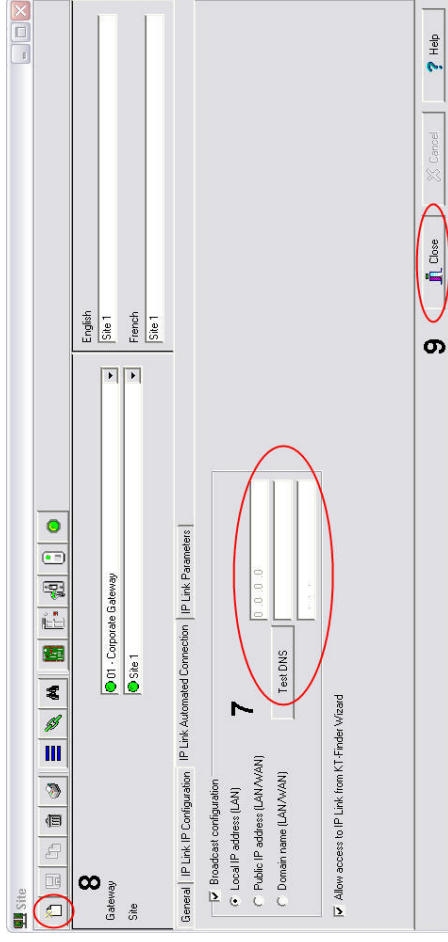

- If the IP Link is installed on the same subnet (LAN) as the PC defined in Step 6, select **Local IP address**
- If the IP Link is installed on a different subnet (WAN), enter the **IP Link Public IP address** (or **Domain name**). Typically, this is the router address/name.

- Click on the floppy icon to save your configuration.
- Close window.
- Go to **Operation > Site**, select the **Gateway**.

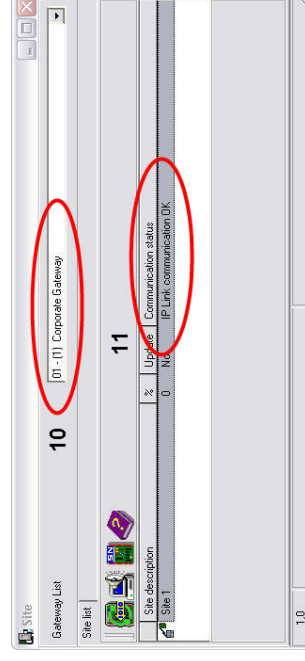

- Verify the **IP Link Communication status**.



---

# Kantech IP Link Enhanced Ethernet Device

## Network Configuration Information Sheet

---

Please complete one sheet per IP Link

Company Name: \_\_\_\_\_

Site Name: \_\_\_\_\_

LAN or  WAN (see other side)

### IP Link Configuration in a Local Area Network (LAN)

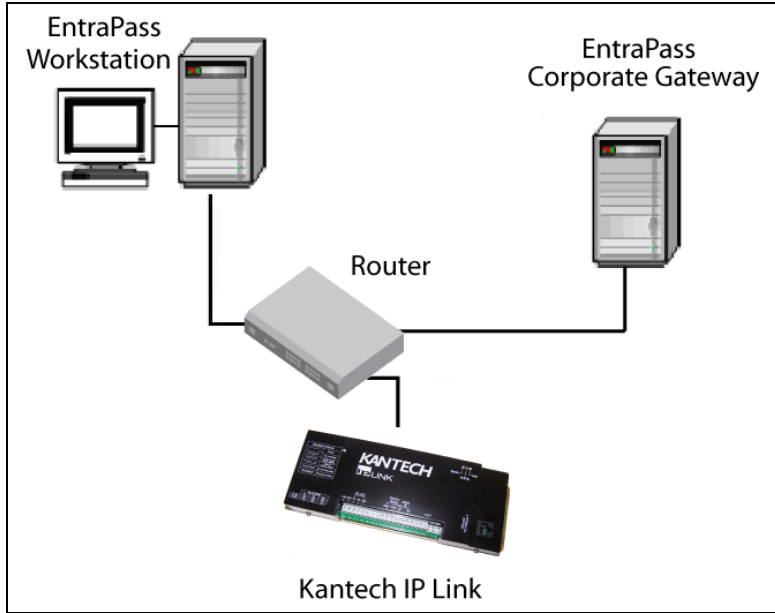

For more details, see Procedure 6: Defining the EntraPass Site on Page 14.

MAC Address: 00:50:F9: \_\_\_\_\_ : \_\_\_\_\_ : \_\_\_\_\_

Protocol: \_\_\_\_\_

Port (UDP only) \_\_\_\_\_

IP Address Type:

DHCP

or

Static

IP Address: \_\_\_\_\_ . \_\_\_\_\_ . \_\_\_\_\_ . \_\_\_\_\_

Subnet Mask: \_\_\_\_\_ . \_\_\_\_\_ . \_\_\_\_\_ . \_\_\_\_\_

Default Gateway (Router): \_\_\_\_\_ . \_\_\_\_\_ . \_\_\_\_\_ . \_\_\_\_\_

### EntraPass Special Edition / Corporate Gateway

IP Address: \_\_\_\_\_ . \_\_\_\_\_ . \_\_\_\_\_ . \_\_\_\_\_

# Network Configuration Information Sheet

## IP Link Configuration in a Wide Area Network (WAN)

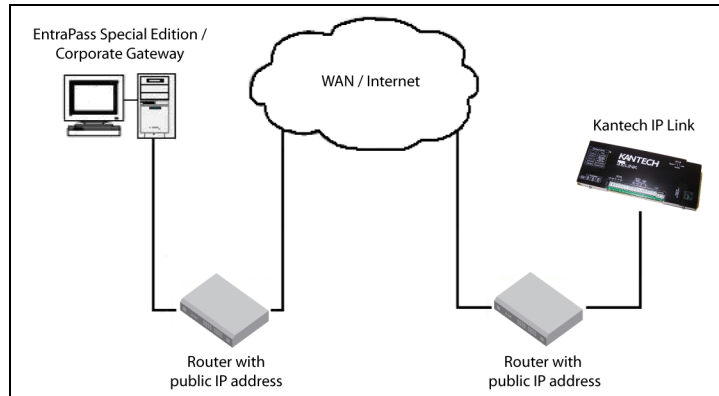

### EntraPass Site

For more details, see Procedure 6: Defining the EntraPass Site on Page 14.

#### EntraPass Special Edition / Corporate Gateway

IP Address: \_\_\_\_\_

#### Router

Public IP Address: \_\_\_\_\_

or

Domain name: \_\_\_\_\_

#### Port Forwarding Checklist

For more details, see Procedure 8: Configuring the IP Link in a WAN/Internet on Page 17.

EntraPass Gateway Ports:  18001 (UDP) and  18801 (UDP) or 18802 (TCP)

### IP Link Site

MAC Address: 00:50:F9: \_\_\_\_\_

IP Address Type:  Static or  Reserved DHCP

IP Address: \_\_\_\_\_

Subnet Mask: \_\_\_\_\_

Default Gateway (Router): \_\_\_\_\_

DNS Server IP Address: \_\_\_\_\_

#### Router

Public IP Address: \_\_\_\_\_ or

Domain name: \_\_\_\_\_

#### Port Forwarding Checklist

**Note 1:** If you are using more than one IP Link at the same remote site, you must use a unique port number for each IP Link.

**Note 2:** No port to forward in TCP.

IP Link Ports:  18803 (UDP) and  18810 (UDP) or \_\_\_\_\_

