



ALARM LOCK

345 Bayview Avenue
Amityville, New York 11701
For Sales and Repairs 1-800-ALA-LOCK
For Technical Service 1-800-645-9440
or visit us at <http://tech.napcosecurity.com/>

(Note: Technical Service is for security professionals only)
Publicly traded on NASDAQ Symbol: NSSC

© ALARM LOCK 2015

Trilogy DL2700LD

Programming Instructions

WI2151 10/15

CONGRATULATIONS!

Your new Alarm Lock Trilogy **DL2700LD** electronic digital lock is a rugged entry lock of advanced design with several programmable features. Three security levels are provided: **Master** (can perform ALL functions), **Manager** (can perform MOST functions plus entry), and **Basic User** (entry only).

The lock includes 100 User Codes (consisting of Managers and Basic Users), plus three "one-time entry" Service Codes. The Manager/Basic User Codes are organized similar to a grid-ten banks of ten Access Codes. In addition, during a crisis or other urgent situation, the model **DL2700LD** features the added ability to receive a wireless "Emergency Lock Down" (**LocDown™**) command sent via a wireless keyfob.

Take the time to read through this guide to familiarize yourself with the features and operations of the lock, and its quick and easy programming procedures.



DL2700LD

FEATURES

- Emergency Lock Down and unlock via wireless keyfob
- 1 Master Code (all functions including entry)
- 10 Manager Codes (perform SOME programming functions plus entry)
- 90 Basic User Access Codes (Entry Only)
- 3 Service Codes ("One-Time Entry" Codes)
- Two User Disable Modes:
 - All User Codes Disabled Except Master Code
 - All User Codes in a Bank Disabled Except Manager Codes
- 30-Second Keypad Anti-Tamper Lockout (Keypad Lockout After 3 Unsuccessful User Code Entries)
- Programmable Relay Functions (Relay may be keypad programmed to energize on any keypress 0-9 or on unlock).
- Locks may be pre-programmed prior to installation. Once installed, locks may immediately be put into use.
- Clearing all User Access Codes only requires a simple two step procedure (see "**Erase All Programming**" on page 13).

QUICK LOOKUP

DL2700LD Keyfob Operation	2
Pairing a Keyfob to the DL2700LD.....	2
Keyfob Low Battery	2
Emergency Lock Down Via Keyfob.....	3
Clear DL2700LD / Keyfob Pairings	3
DL2700LD Wiring	4
DL2700LD Quick Start.....	4
Testing Codes	5
Manager & User Location Worksheet.....	6
Manager & User Location Example.....	7
Programming Worksheet: Functions	8
Change Existing Master Code	9
Add/Change Manager Codes.....	9
Add/Change User Codes	9
Deleting Codes.....	9
Disable/Enable Users.....	9
Enable/Disable All	10
Code Location Function	10
Next Free Code Address Locator.....	10
Add/Delete Service Codes	11
Enable/Disable Passage Mode	11
Pass Time ("Door Unlock")	11
Disable/Enable Groups	11
Disable/Enable Users in Bank.....	12
Keypress Sound Options	12
AUX Relay Functions.....	12
Sounder on Emergency Lock Down.....	12
Lock Identifier.....	12
DL2700LD Audible and LED Indications	13
Erase All Programming.....	13
DL2700LD Battery Replacement.....	14
Keyfob Battery Replacement.....	14
Additional Manager & User Location Worksheet.....	15
Alarm Lock Limited Warranty	16

DL2700LD Keyfob Operation

The **DL2700LD** is equipped with a receiver located inside the battery compartment that accepts wireless commands sent from a "paired" wireless keyfob (provided). Once paired, the keyfob can transmit a simple "unlock" command, or during an urgent situation the keyfob can send an "**Emergency Lock Down**" command forcing all (paired) **DL2700LD** locks to lock indefinitely. Later, a "**Return to Normal**" command can be sent, reverting all (paired) **DL2700LD** locks back to the state they were in prior to the transmission of the Emergency Lock Down command.

Up to four **DL2700LD** locks may be paired to a single keyfob; up to 50 individual keyfobs may be paired to a single **DL2700LD**.

Note: The wireless keyfob provided with your **DL2700LD** is a model **RR-4BKEYFOB** 4-Button Pocket-Size Remote Keyfob, and may be purchased individually from your Alarm Lock dealer. Although the **RR-1BUTTON** Single Button Remote keyfob is also compatible with the **DL2700LD**, you cannot use an **RR-1BUTTON** to initiate **Emergency Lock Down**. All references to "keyfob" or "wireless remote" in this manual are referring to this model **RR-4BKEYFOB** unless otherwise stated.

Pairing a Keyfob to the DL2700LD

Each of the four buttons on the RR-4BKEYFOB can be "paired" (connected) with one **DL2700LD** series lock. This means, for example, the four buttons on the RR-4BKEYFOB can each be paired with four separate **DL2700LD** series locks. **Note:** Since each button can ONLY be paired with one specific **DL2700LD** lock at a time, when a previously paired button is later paired with a second **DL2700LD** lock, the first pairing is erased.

After lock installation on the door is complete and the lock is powered, be sure to have the **RR-4BKEYFOB** wireless keyfob powered and ready. Pair a keyfob button to a **DL2700LD** lock as follows:

Before you begin, note that the pairing steps below must all be performed within thirty (30) seconds. Therefore, before proceeding, *read through the steps first* to become familiar with this simple procedure.

1. Select a keyfob button that you wish to pair. Selecting a button in advance will greatly assist this process. Keep the keyfob **in your hand** as you perform the next steps.
2. Press and release the **DL2700LD** Program Button (see image at right). The green LED on the back of the battery cover will turn on, indicating the **DL2700LD** is ready to pair ("pairing mode" begins). Within 30 seconds perform the next step.
(Note: If you wish to cancel "pairing mode", simply press and release the Program Button again; the green LED will flicker and turn off).
3. Immediately **press and hold** the chosen keyfob button and observe the keyfob LED:
 - a. The red LED lights...keep holding the button...
 - b. The LED flashes green, release the button...
 - c. Wait and observe the LED as follows:
 - **LED solid green** = Pairing successful (the green LED on the battery cover flashes twice)
 - **LED solid red** = Pairing unsuccessful, start again at step 1.
4. Press and release the Program Button on the **DL2700LD** again; the green LED will flicker and turn off.
5. **Test the keyfob:** Press and release the paired button; ensure the **DL2700LD** unlocks for the Pass Time.



Integral DL2700LD Receiver Program Button

Keyfob Low Battery

When any button on the keyfob is pressed and its battery is weak, the LED on the keyfob will flash red-green for several seconds. Always replace a weak battery as soon as possible. Use a 3V lithium type CR2032 or Duracell DL2032 only.

IMPORTANT: DO NOT press any buttons while changing the battery.

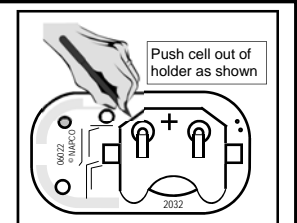

DL2700LD Keyfob Operation (cont'd)

Emergency Lock Down Via Keyfob

What is "Emergency Lock Down"?

In a crisis or other urgent situation, the **DL2700LD** can be placed into an Emergency state, securing protected doors from unwarranted passage. During Emergency Lock Down, the LED on the battery cover on the **DL2700LD** will flash red once every second. **Note:** An optional 30-second sounder may be programmed to activate upon Emergency Lock Down (see "**Sounder on Emergency Lock Down**" on page 12).

Who has Access during "Emergency Lock Down"?

During Emergency Lock Down, Users with a security level of Master or Manager are allowed access (can unlock the physical lock). All "Basic" Users are denied access during Emergency Lock Down. See page 9 to add Manager Codes.

How to Initiate Emergency Lock Down

Press and hold buttons **3** and **4** simultaneously -- Within seconds an "Emergency Lock Down" command is sent to the **DL2700LD** (or up to 4 locks paired to the keyfob).

How to "Return to Normal"

Press and hold buttons **1** and **2** simultaneously -- Within seconds a "Return to Normal" command is sent to the **DL2700LD** (or up to 4 locks paired to the keyfob) returning the lock (or locks) back to "normal" operating mode.

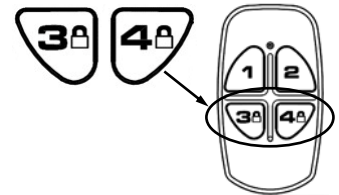

Press 3 and 4 simultaneously to enter Emergency Lock Down

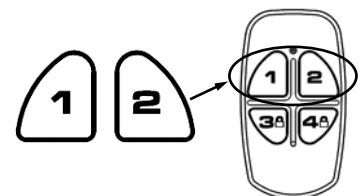

Press 3 and 4 simultaneously to "Return to Normal"

Clear DL2700LD / Keyfob Pairings

Since pairing is between the keyfob and the **DL2700LD** integral receiver, the "**Erase All Programming**" procedure (on page 13) will NOT clear this pairing. Therefore pairings may be cleared in one of two ways:

- **Clear Receiver** (clears ALL paired keyfobs)
- **Clear Keyfob** (clears keyfob's pairing)

Note: If only one keyfob has been paired to the **DL2700LD**, you can use either method below.

Clear Receiver (Clear All Pairings)

1. Remove the **DL2700LD** battery cover.
2. Disconnect battery pack. Wait 3 seconds.
3. Reconnect battery pack.
4. Within 5 seconds, press and hold the Program Button until the green LED (on battery cover) starts to flash rapidly.
5. Carefully re-insert the battery pack and all wires and secure battery cover.

Clear Keyfob

1. Carefully open the keyfob by inserting the edge of a small coin or a flathead screwdriver in the notch located in the bottom right corner of the keyfob. Lift off the top cover.
2. Carefully remove the circuit board.
3. On the back of the circuit board, push the battery cell out of its metal holder. *Note the orientation of the cell polarity (positive side up).*
4. Press and hold any keyfob button...do not release the button...
5. Re-insert the battery (*positive (+) side up*)...continue holding the button...
6. While holding the keyfob button, observe the keyfob LED: When the LED toggles rapidly between red and green, release the button.
7. Carefully reassemble keyfob (with its rubber button/gasket in place). Press to snap the top and bottom keyfob covers together to close.

DL2700LD Wiring

See the Installation Instructions for more information.

Batteries:

Use five (5) Duracell alkaline size-AA 1.5 volt batteries.

External Power:

An external 7.5 VDC Power Source, capable of at least 100mA, must be used for operation without batteries in the lock. Use an external UL-Listed power supply provided with backup battery power and current limiting protection that is approved for the application. Black = Negative, Red = Positive.

Aux Relay:

Allows up to 300mA @ 60VDC maximum. See page 12 for programming options for the Relay ("**AUX Relay Functions**"). Blue = Common, Yellow = N/O, Green = N/C.



Remote Switch Input (2 White Wires)

At the factory, the two white wires are connected to the integral receiver, allowing for wireless unlocking and/or Emergency Lock Down via the (supplied) keyfob.

Two functions are also available (see "**Remote Switch Input**" function on page 11 for programming steps).

DL2700LD Quick Start

First Time Start Up









1. Unpack the lock from its factory packaging.
2. With the batteries disconnected, hold down any number key for 10 seconds and release.
3. Connect the batteries and--within 3 seconds--press and hold the  button. After hearing 6 beeps, release the  button. Wait 5 seconds for lock to re-lock (listen for 1 beep and red LED). The lock is now ready to accept programming. **Note:** Failure to follow this exact procedure can result in erratic lock behavior.

Important Note: When entering any of the programming key sequences that follow, *do not pause more than 5 seconds between any key presses*--otherwise you must start again. (**Note:** If you wish, this 5-second delay between key presses can be extended--see "**Pass Time**" on page 11 after completing this section).

No other programming commands will be accepted until the Factory Master Code has been changed.

Change Factory Master Code









The Master Code is a "secret" code (entered at the keypad) that allows you to change ALL programming functions and options. Because all locks are manufactured identically (and leave the factory with the *same* Master Code), this "factory Master Code" is not very secret--and **MUST** be changed to your own personal Master Code to ensure security. A 6 digit Code is recommended.

1. Press the factory Master Code:     . A beep will sound and the lock will open.
2. Within 5 seconds, press   .
3. Within 5 seconds, enter a new Master Code. This new Master Code may consist of 3 to 6 digits*, however, the number of digits selected determines the number required for all subsequent Manager and User Access Codes.
4. Press .
5. Re-enter the new Master Code again to validate. A 6-beep acknowledgement (with a red LED) will sound. Wait 5 seconds for lock to re-lock.
6. Test the new Master Code. Enter the new Master Code; a beep will sound and the lock will unlock. Now that the Master Code has been changed, there is no need to change it again (unless you want to).

For example, if you want your new Master Code to be "44444", press:

                  .

If you wish, write your new Master Code in the spaces provided:

        _____  _____
Write your new Master Code (Repeat)

* Once the number of digits is selected, it cannot be changed unless all programming is erased and the factory default settings are re-loaded using the "**Erase All Programming**" procedure found on page 13.

Quick Start (cont'd)

Enter a Manager Code

Manager Codes are located at locations 00, 10, 20, 30, 40, 50, 60, 70, 80, and 90 (see grid on page 6). **Note:** New Manager Codes MUST use the same number of digits as the (new) Master Code. Enter as follows.

1. Press the (new) Master Code.
2. Press [press a Manager location i.e. 00, 10, 20, 30, 40, 50, 60, 70, 80, or 90] .
3. Press a new Manager Code using the same number of digits as the (new) Master Code. A 6-beep acknowledgement (with a red LED) will sound. Wait 5 seconds for lock to re-lock.
For example, if you want to add a Manager Code of "33333" in location 00,
[Press the (new) Master Code] .
4. If lock remains open, repeat from step 2; otherwise restart from step 1 for each new Manager Code.

Enter Basic User Access Codes

See the grid on page 6 for more information regarding User locations. You can choose to enter your User Codes in many possible locations, and in any order you wish. User Codes do not have programming privileges (entry only). Duplicate User Codes are not allowed.

1. Press the (new) Master Code or associated Manager Code.
2. Press [press a 2-digit location number] .
3. Press a new User Access Code using the same number of digits as the (new) Master Code. A six-beep acknowledgement (with a red LED) will sound. Wait 5 seconds for lock to re-lock. The new User Access Code is now entered in that location number.
For example, if you want to add a User Access Code of "22222" in User Number 01, press:
[(New) Master Code] .
4. If lock remains open, repeat from step 2; otherwise restart from step 1 for each new User Access Code.

Delete a User Access Code

The Master Code cannot be deleted. Manager Codes can only be deleted with the Master Code. If the location (User Number) of the Code is unknown, use the "**Code Location Function**" (page 10).

1. Press the (new) Master Code or Manager Code.
2. Press [press the 2-digit location number] . A six-beep acknowledgement (with a red LED) will sound. Wait 5 seconds for lock to re-lock. The User Access Code is now deleted.
For example, if you want to delete a User Access Code located in location 47, press:
[(New) Master/Manager Code] .
3. If lock remains open, repeat from step 2; otherwise restart from step 1 for each User Access Code you want to delete.

Testing Codes

VALID CODE - The green LED will flash (with 1 beep) after a valid code is entered. The lock will unlock immediately and remain unlocked for about 5 seconds (this "unlocked" time is the "Pass Time"). To make the Pass Time longer or shorter, use the "**Pass Time**" Function on page 11. **Note:** While the lever or knob may be rotated at any time, the latch will not be engaged to unlock the door unless a valid User Access Code is entered at the keypad.

INVALID CODE - The red LED will flash 5 times (with 5 beeps) after an invalid code is entered. (To quickly clear an invalid User Access Code, press and immediately re-enter the correct Code).

KEYPAD ANTI-TAMPER LOCKOUT - When the **DL2700LD** is locked, if 3 invalid User Access Codes are entered in succession, the lock will turn off for approximately 30 seconds to prevent tampering. The **DL2700LD** will emit 2 beeps with a red LED flash warning at the end of the anti-tamper period. The lock will exit Anti-Tamper mode in 30 seconds or upon activation of the Remote Switch Input. **Note:** The lock will go into Anti-Tamper mode after 3 unsuccessful entries *even if entered by different users and spaced apart in time*. Therefore, be aware that the lock may seem to "appear" to go into Anti-Tamper Lockout *even after the entry of just one invalid User Access Code*.

Manager & User Location Worksheet

The **DL2700LD** lock provides three "security levels": **Master** (can perform ALL functions), **Manager** (can perform SOME programming functions plus entry), and **Basic User** (entry only). In total, there are 104 "locations" inside the **DL2700LD** lock: One Master Code, 10 Manager and 90 User Access Codes, and three "one-time entry" Service Codes. *Where the Access Code is located will determine its security level.* From the factory, all locations (except for the Master Code) are empty; each location can then be programmed to contain an Access Code, and these Access Codes enable Users to program and/or unlock the lock. As a visual aid, the 100 Manager/User Access Code locations are detailed in the grid below, with ten "Banks" (columns) of ten "Managers/Users" (rows). Each of the 100 squares in the grid is identified by a unique two-digit location (00) through (99). Notice that these two digits also specify its Bank (column) and Manager/User (row) location in the grid. Also notice that all Managers are in the top row, their locations all ending in a zero (locations 00, 10, 20, 30 and so on through 90). **Note:** Use the blank grid below as a **Programming Worksheet** for preparing all programming in advance. Store this worksheet in a safe place for future reference (an extra worksheet appears on page 15).

Each square represents a location inside the lock (excluding the Master Code and the 3 Service Codes). Each location can hold one "User Access Code" which can unlock the lock.

	BANK 0	BANK 1	BANK 2	BANK 3	BANK 4	BANK 5	BANK 6	BANK 7	BANK 8	BANK 9
MANAGERS →	MGR 00 -----	MGR 10 -----	MGR 20 -----	MGR 30 -----	MGR 40 -----	MGR 50 -----	MGR 60 -----	MGR 70 -----	MGR 80 -----	MGR 90 -----
USERS →	USER 01 -----	USER 11 -----	USER 21 -----	USER 31 -----	USER 41 -----	USER 51 -----	USER 61 -----	USER 71 -----	USER 81 -----	USER 91 -----
USERS →	USER 02 -----	USER 12 -----	USER 22 -----	USER 32 -----	USER 42 -----	USER 52 -----	USER 62 -----	USER 72 -----	USER 82 -----	USER 92 -----
USERS →	USER 03 -----	USER 13 -----	USER 23 -----	USER 33 -----	USER 43 -----	USER 53 -----	USER 63 -----	USER 73 -----	USER 83 -----	USER 93 -----
USERS →	USER 04 -----	USER 14 -----	USER 24 -----	USER 34 -----	USER 44 -----	USER 54 -----	USER 64 -----	USER 74 -----	USER 84 -----	USER 94 -----
USERS →	USER 05 -----	USER 15 -----	USER 25 -----	USER 35 -----	USER 45 -----	USER 55 -----	USER 65 -----	USER 75 -----	USER 85 -----	USER 95 -----
USERS →	USER 06 -----	USER 16 -----	USER 26 -----	USER 36 -----	USER 46 -----	USER 56 -----	USER 66 -----	USER 76 -----	USER 86 -----	USER 96 -----
USERS →	USER 07 -----	USER 17 -----	USER 27 -----	USER 37 -----	USER 47 -----	USER 57 -----	USER 67 -----	USER 77 -----	USER 87 -----	USER 97 -----
USERS →	USER 08 -----	USER 18 -----	USER 28 -----	USER 38 -----	USER 48 -----	USER 58 -----	USER 68 -----	USER 78 -----	USER 88 -----	USER 98 -----
USERS →	USER 09 -----	USER 19 -----	USER 29 -----	USER 39 -----	USER 49 -----	USER 59 -----	USER 69 -----	USER 79 -----	USER 89 -----	USER 99 -----

MASTER CODE

SERVICE CODE 1

SERVICE CODE 2

SERVICE CODE 3

LOCK DESCRIPTION

Manager & User Location Example

User Access Codes allow access only; *Manager Codes* allow more: Manager Codes have the ability to program and delete User Access Codes within that Manager's Bank (column). The **DL2700LD** lock can hold up to 10 Manager Codes, one for each Bank (locations (00), (10), (20), (30), (40), (50), (60), (70), (80), (90)), and are all found at the top row of the grid below. **Note:** Only the Master Code can add or delete a Manager Code.

In addition, Managers not only possess programming abilities for User Access Codes residing in their own Bank, but also for *all higher Banks until the next programmed Manager Code appears*.

For example (see shaded grid below), if Manager Codes are programmed for locations (00) and (60), then the Manager in location (00) has control of the gray-shaded locations (00-09, 11-19, 21-29, 31-39, 41-49, and 51-59). The Manager in location (60) then has control over the black-shaded locations (61-69, 71-79, 81-89, and 91-99).

Note: If you wish to grant any Manager the ability to program any User, use the "Disable Groups" Function on page 11 (Enter the Master Code, then press).

	Manager Code Programmed here						Manager Code Programmed here			
	(BANK 0)	(BANK 1)	(BANK 2)	(BANK 3)	(BANK 4)	(BANK 5)	(BANK 6)	(BANK 7)	(BANK 8)	(BANK 9)
MANAGERS	MGR 00	MGR 10 (BLANK)	MGR 20 (BLANK)	MGR 30 (BLANK)	MGR 40 (BLANK)	MGR 50 (BLANK)	MGR 60	MGR 70 (BLANK)	MGR 80 (BLANK)	MGR 90 (BLANK)
→	→						→			
USERS	USER 01	USER 11	USER 21	USER 31	USER 41	USER 51	USER 61	USER 71	USER 81	USER 91
→	→						→			
USERS	USER 02	USER 12	USER 22	USER 32	USER 42	USER 52	USER 62	USER 72	USER 82	USER 92
→	→						→			
USERS	USER 03	USER 13	USER 23	USER 33	USER 43	USER 53	USER 63	USER 73	USER 83	USER 93
→	→						→			
USERS	USER 04	USER 14	USER 24	USER 34	USER 44	USER 54	USER 64	USER 74	USER 84	USER 94
→	→						→			
USERS	USER 05	USER 15	USER 25	USER 35	USER 45	USER 55	USER 65	USER 75	USER 85	USER 95
→	→						→			
USERS	USER 06	USER 16	USER 26	USER 36	USER 46	USER 56	USER 66	USER 76	USER 86	USER 96
→	→						→			
USERS	USER 07	USER 17	USER 27	USER 37	USER 47	USER 57	USER 67	USER 77	USER 87	USER 97
→	→						→			
USERS	USER 08	USER 18	USER 28	USER 38	USER 48	USER 58	USER 68	USER 78	USER 88	USER 98
→	→						→			
USERS	USER 09	USER 19	USER 29	USER 39	USER 49	USER 59	USER 69	USER 79	USER 89	USER 99
→	→						→			

Manager Location Example



Programming Functions

Change Existing Master Code*

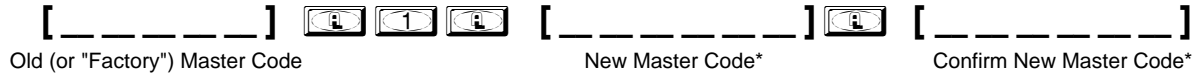
For new locks, follow the "Quick Start" on page 4.



Add/Change Manager Codes [] [0 icon]

Follow the "Quick Start" on page 4. **Note:** You can also add/change the Manager Code in location 00 by entering the Master Code,    then the new Manager Code.

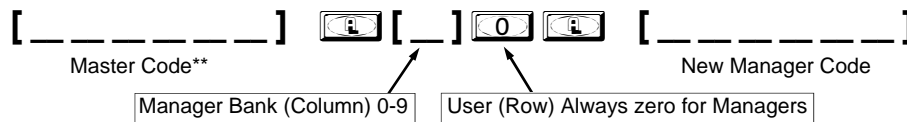

Add/Change User Codes [] []

Follow the "Quick Start" on page 5.

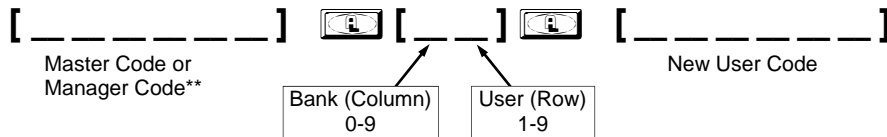

Deleting Manager & User Codes [] []

Follow the "Quick Start" on page 5.

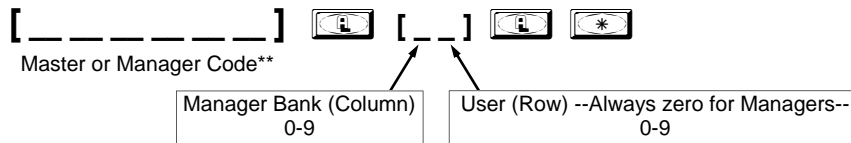

Disable/Enable Users

Enter the Master Code to disable/enable any Manager or User, or enter a Manager Code to disable any User within the Manager's Bank.

Disable User Number [] [lock icon] [] [lock icon] (Allow system to reload)
 Master or Manager Code Bank/User Number

Enable User Number [] [lock icon] [] [lock icon] (Allow system to reload)
 Master or Manager Code Bank/User Number

* Once the number of digits is selected, it cannot be changed unless all programming is erased and the Factory Default settings are re-loaded (power must be removed and re-applied as per the "Erase All Programming" procedure found on page 13.

** Required only if DL2700LD is locked.

Programming Functions (cont'd)

Enable/Disable All





Disable All: If Master Code is used, disables all 100 User/Manager Codes and clears all 3 Service Codes. If a Manager Code is used, disables all Users (even across multiple Banks) under that Manager.

Disable Users Only: If Master Code is used, disables all 90 Users and clears all 3 Service Codes, while Managers remain active. If a Manager Code is used, disables all Users (even across multiple banks) under that Manager.

Enable All: If Master Code is used, re-enables all 100 User/Manager Codes (Service Codes must be re-programmed). If a Manager Code is used, re-enables all Users (even across multiple Banks) under that Manager. **Note:** Managers cannot disable themselves. Use Function 944 to restore Functions 955 and 950. In addition, if Codes are disabled using Function 955 or 950, and a new User Code is subsequently added (or an existing Code changed), the new (or changed) User Code will automatically become enabled.



Disable All [_ _ _ _ _]     
Master/Manager Code**

Disable Users Only [_ _ _ _ _]     
Master/Manager Code**

Enable All [_ _ _ _ _]     
Master/Manager Code**

Code Location Function

Be sure to record all Code locations in the blank worksheet (page 15) for future reference. If the location of a Code is not known, use this function to find the Code. The lock will identify the BANK (0-9) and USER (0-9) by beeping and flashing the GREEN LED 0 to 9 times as detailed below.

[_ _ _ _ _]    [_ _ _ _ _]
Master/Manager Code** Code 2 - 5 digits



If the code entered is recognized, the following sequence will occur:

1. At the start of the Code Location sequence, the lock will Flash both the GREEN and RED LED's and will emit a low tone.
2. The lock will identify the **Bank** number by flashing the GREEN LED and beeping the sounder from 0-9 times.
3. To signify the end of the Bank number ID sequence, the lock will flash both the GREEN and RED LED's and will emit a low tone.
4. The lock will identify the **User** number by flashing the GREEN LED and beeping the sounder from 0-9 times.
5. To signify the end of the Code Location function, the lock will flash both the GREEN and RED LED's and will emit a low tone.

Note: Should the Code not be recognized, the lock will sound 5 beeps with a RED LED. **When the Bank and/or slot numbers are zero, the GREEN LED will not flash and the sounder will not beep.**

Next Free Code Address Locator

Using the same method of beeps and flashes used in the Code Location Function, and dependent on the Master or Managers Code entered, the lock will report the next available address for User Access Code programming.



[_ _ _ _ _]   
Master/Manager Code**





Report Sequence





1. At the start of the Next Free Code Location function, the lock will Flash both the GREEN and RED LED's and will emit a low tone.
2. The lock will identify the **Bank** number by flashing the GREEN LED and beeping the sounder from 0-9 times.
3. To signify the end of the Bank number ID sequence, the lock will flash both the GREEN and RED LED's and will emit a low tone.
4. The lock will identify the **User** number by flashing the GREEN LED and beeping the sounder from 0-9 times.
5. To signify the end of the Code Location function, the lock will flash both the GREEN and RED LED's and will emit a low tone. If no free address is found, then the lock will emit a programming error tone sequence. **No LED flashes/sounder beeps represent the number zero.**





Programming Functions (cont'd)





Add/Delete Service Codes

Service Codes are one-time-only Codes; once entered into the keypad, it is deleted. Use the same Code up to 3 times by programming all three Service Codes with the same Code. **Note:** Service Codes are lost if power is removed. To delete a single Service Code, press , enter Service Code number (301, 302 or 303), then press  .

Service Code 1 [_____]      [_____]
Master/Manager Code** New Service Code



Service Code 2 [_____]      [_____]
Master/Manager Code** New Service Code



Service Code 3 [_____]      [_____]
Master/Manager Code** New Service Code

Delete All Service Codes [_____]     
Master/Manager Code**

Enable/Disable Passage Mode



Allows passage without the need to enter a Code into the keypad.

Enable Passage Mode [_____]    ("Unlocked")
Master or Manager Code**

Disable Passage Mode [_____]    ("Normal Operation")
Master or Manager Code**

Pass Time ("Door Unlock")





The Pass Time is the time the lock stays unlocked after a valid Code entry. Use the function below to change the Pass Time from 02 to 20 seconds. The Pass Time factory default is 5 seconds. **NOTE:** The Pass Time will also determine the amount of time allowed between keypresses during programming.





Pass Time [_____]   [____] 
Master Code** Pass Time

Remote Switch Input

Default Setting: Press button on paired keyfob to unlock the DL2700LD; at the end of the Pass Time, the DL2700LD re-locks automatically.

Toggle Passage: Press button on paired keyfob to enter Passage Mode (short tone sounds); subsequent button press on paired keyfob will exit Passage Mode (long tone sounds).





Default Setting [_____]     
Master Code**





Toggle Passage [_____]     
Master Code**

Disable/Enable Groups

Disable Groups: All Managers can program all User Access Codes, regardless of Bank.

Enable Groups: (Factory default) Managers restricted to controlling only those User Access Codes within their own Bank (column), and all following Banks until another Manager appears. User Access Codes in Banks outside of that Manager's Bank cannot be programmed.





Disable Groups [_____]     
Master Code**





Enable Groups [_____]     
Master Code**

** Required only if DL2700LD is locked.

Programming Functions (cont'd)

Disable/Enable Users in Bank Enter Bank number (0-9) to Enable/Disable all Users in Bank. Entering a disabled Code will result in an accented five beep error tone (indicating the User Code is valid but disabled).





Disable Users in Bank [_____]    [_] 
Master/Manager Code** Bank Number





Enable Users in Bank [_____]    [_] 
Master/Manager Code** Bank Number





Keypress Sound Options





The **DL2700LD** is capable of emitting 1 of 4 possible keypress sounds:

- High Frequency Keypad Feedback + LED (default)
- Low Frequency Keypad Feedback + LED
- "Click!" Keypad Feedback + LED
- LED Only



High Freq KP Keypress Sound + LED (Default) [_____]     
Master Code**





Low Freq KP Keypress Sound + LED [_____]     
Master Code**

Click! KP Keypress Sound + LED [_____]     
Master Code**

LED Only [_____]     
Master Code**

AUX Relay Functions The functions below activate or deactivate the Auxiliary Relay on any numeric keypress (Function 201), or when the **DL2700LD** is unlocked (Function 202) (in either case the Aux Relay is active for the Pass Time duration; see page 4 for Aux Relay wiring information).





Disable AUX Relay Function [_____]     
Master Code**





AUX Relay on Any First Keypress (0-9) [_____]     
Master Code**

AUX Relay When Unlocked [_____]     
Master Code**

Sounder on Emergency Lock Down

Upon the initiation of Emergency Lock Down, an optional 30-second sounder can be programmed to annunciate, alerting of the Emergency status. **Note:** When enabled, this "Sounder on Emergency Lock Down" overrides all "Keypress Sound Options" on page 12.

Disable Sounder (default) [_____]     
Master Code**





Enable Sounder [_____]     
Master Code**

Lock Identifier

To help distinguish your lock model from earlier versions, your **DL2700LD** will respond to any two digits plus the star key by lighting the green LED and by playing a musical scale of 8 notes.

Lock Identifier [_] [_] 
(Any Two Digits)



DL2700LD Audible and LED Indications

The **DL2700LD** provides visual and audible keypad feedback. For example, when a key is pressed, a beep will sound and a red LED will flash. **Note:** Keypress tones may be disabled using      (see "**Keypress Sound Options**", page 12). With a fully charged battery, the LED and sounder feedback include the following:

ACTIVITY	LED	SOUNDER	COMMENTS
Keypress	1 Red Flash	1 Beep	Normal Operation
Access Granted	1 Green Flash	1 Beep	Valid Code. After the Pass Time, the DL2700LD re-locks with a beep and a red LED flash.
Invalid Code	5 Red Flashes	5 Beeps	
New Access Code Accepted	6 Red Flashes	6 Beeps	
Programming Error	5 Red Flashes	2 Sets of 5 Beeps	
Return from Anti Tamper Lockout	1 Red Flash	2 Beeps	
Remote Switch Input (Keyfob) Toggle Passage	<u>Enter Passage Mode:</u> 1 second Beep and a Green Flash. <u>Exit Passage Mode:</u> 2 second Beep and a Red Flash.		See page 11 for more information.
Valid but Disabled Code	5 Red Flashes	5 Beeps (with extended first beep)	Code exists in memory, but disabled.
Low Battery	High / Low Sounder with flashing red LED for 5 seconds		See page 14 before changing batteries; see page 11 for the definition of "Pass Time".
Enter Emergency Lock Down	1 Red Flash	3 Sets of 2 Beeps	See page 3 for more information.
In Emergency Lock Down	1 Red Flash per second (Front and Battery Covers)	(see COMMENTS)	For optional " Sounder on Emergency Lock Down ", see page 12.
"Return to Normal" (Exit Emergency Lock Down)	1 Red Flash plus 5 Green Flashes on Battery Cover	3 Sets of 2 Beeps	See page 3 for more information.

Erase All Programming

Restore Factory Default (original settings that were set at the factory will be loaded).

1. Remove the battery pack, and with the batteries disconnected, press any numeric key for 10 seconds and release.
2. Connect the batteries and--within 3 seconds--press and hold . After hearing 6 additional beeps, release .

The **DL2700LD** is now clear of all programmed data, and the lock is now ready to accept new programming. **Important:** If you do not hear these 6 beeps, you must start over at step 1. Failure to follow this exact procedure can result in erratic lock behavior.

 This procedure does **NOT** affect keyfob pairings. See page 3 to clear pairings.

DL2700LD Battery Replacement

When the batteries are weak and a key is pressed, the lock will alert you by flashing the RED LED accompanied by a high/low sounder. The **DL2700LD** uses five AA-size 1.5 volt alkaline batteries. Always replace weak batteries as soon as possible.

The **DL2700LD** is equipped with special "non-volatile" memory, therefore if power is lost for ANY length of time (such as when replacing batteries or if the batteries die), all existing User Codes and paired keyfobs are retained indefinitely.

Do not press any keys while batteries are disconnected unless you intend to erase all programming.

1. Remove the screw from the battery cover and remove.
2. Remove battery pack and replace all 5 batteries. **Do not** press any keys.
3. Replace battery pack and battery cover. Tighten the cover screw to secure.

If you accidentally press a key, use the **Retain Lock Programming** procedure below:

Retain Lock Programming

1. Re-install battery pack.
2. **Do not** press any keys for 10 seconds.

If you do not hear any beeps or if you hear 3 beeps (one per second), the previous lock programming **is retained** and the lock is now ready for use.

If you test the **DL2700LD** and find the lock programming is lost, you may erase all programming and return the **DL2700LD** to its original factory settings, as described in "**Erase All Programming**" on page 13.

Keyfob Battery Replacement

The keyfob uses a 3V lithium type CR2032 or Duracell DL2032 only. Always replace weak batteries as soon as possible.

DO NOT press any buttons while changing the battery.

1. **Carefully open the keyfob** by inserting the edge of a small coin or a flathead screwdriver in the notch located in the bottom right corner of the keyfob. Lift off the top cover.
2. **Carefully remove the circuit board.**
3. **On the back of the circuit board**, push the battery cell out of its metal holder. *Note the orientation of the cell polarity (positive side up).*
4. **Replace with a new battery, positive (+) side up**, by sliding the battery into its metal bracket.
5. **Carefully reassemble keyfob** (with its rubber button/gasket in place). Press to snap the top and bottom keyfob covers together to close. see page 2 for "**Keyfob Low Battery**" indication.

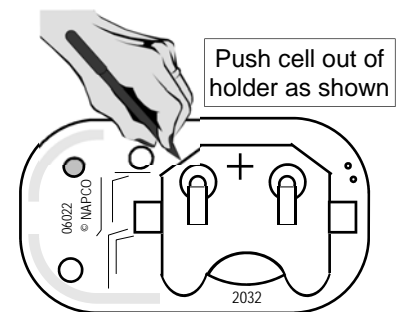

Additional Manager & User Location Worksheet

The **DL2700LD** lock provides three "security levels": **Master** (can perform ALL functions), **Manager** (can perform SOME programming functions plus entry), and **Basic User** (entry only). In total, there are 104 "locations" inside the **DL2700LD** lock: One Master Code, 10 Manager and 90 User Access Codes, and three "one-time entry" Service Codes. *Where the Access Code is located will determine its security level.* From the factory, all locations (except for the Master Code) are empty; each location can then be programmed to contain an Access Code, and these Access Codes enable Users to program and/or unlock the lock. As a visual aid, the 100 Manager/User Access Code locations are detailed in the grid below, with ten "Banks" (columns) of ten "Managers/Users" (rows). Each of the 100 squares in the grid is identified by a unique two-digit location (00) through (99). Notice that these two digits also specify its Bank (column) and Manager/User (row) location in the grid. Also notice that all Managers are in the top row, their locations all ending in a zero (locations 00, 10, 20, 30 and so on through 90). **Note:** Use the blank grid below as a **Programming Worksheet** for preparing all programming in advance. Store this worksheet in a safe place for future reference.

Each square represents a location inside the lock (excluding the Master Code and the 3 Service Codes). Each location can hold one "User Access Code" which can unlock the lock.

	BANK 0	BANK 1	BANK 2	BANK 3	BANK 4	BANK 5	BANK 6	BANK 7	BANK 8	BANK 9
MANAGERS →	MGR 00 -----	MGR 10 -----	MGR 20 -----	MGR 30 -----	MGR 40 -----	MGR 50 -----	MGR 60 -----	MGR 70 -----	MGR 80 -----	MGR 90 -----
USERS →	USER 01 -----	USER 11 -----	USER 21 -----	USER 31 -----	USER 41 -----	USER 51 -----	USER 61 -----	USER 71 -----	USER 81 -----	USER 91 -----
USERS →	USER 02 -----	USER 12 -----	USER 22 -----	USER 32 -----	USER 42 -----	USER 52 -----	USER 62 -----	USER 72 -----	USER 82 -----	USER 92 -----
USERS →	USER 03 -----	USER 13 -----	USER 23 -----	USER 33 -----	USER 43 -----	USER 53 -----	USER 63 -----	USER 73 -----	USER 83 -----	USER 93 -----
USERS →	USER 04 -----	USER 14 -----	USER 24 -----	USER 34 -----	USER 44 -----	USER 54 -----	USER 64 -----	USER 74 -----	USER 84 -----	USER 94 -----
USERS →	USER 05 -----	USER 15 -----	USER 25 -----	USER 35 -----	USER 45 -----	USER 55 -----	USER 65 -----	USER 75 -----	USER 85 -----	USER 95 -----
USERS →	USER 06 -----	USER 16 -----	USER 26 -----	USER 36 -----	USER 46 -----	USER 56 -----	USER 66 -----	USER 76 -----	USER 86 -----	USER 96 -----
USERS →	USER 07 -----	USER 17 -----	USER 27 -----	USER 37 -----	USER 47 -----	USER 57 -----	USER 67 -----	USER 77 -----	USER 87 -----	USER 97 -----
USERS →	USER 08 -----	USER 18 -----	USER 28 -----	USER 38 -----	USER 48 -----	USER 58 -----	USER 68 -----	USER 78 -----	USER 88 -----	USER 98 -----
USERS →	USER 09 -----	USER 19 -----	USER 29 -----	USER 39 -----	USER 49 -----	USER 59 -----	USER 69 -----	USER 79 -----	USER 89 -----	USER 99 -----

MASTER CODE

SERVICE CODE 1

SERVICE CODE 2

SERVICE CODE 3

ALARM LOCK LIMITED WARRANTY

ALARM LOCK SYSTEMS, INC. (ALARM LOCK) warrants its products to be free from manufacturing defects in materials and workmanship for twenty four months following the date of manufacture. ALARM LOCK will, within said period, at its option, repair or replace any product failing to operate correctly without charge to the original purchaser or user.

This warranty shall not apply to any equipment, or any part thereof, which has been repaired by others, improperly installed, improperly used, abused, altered, damaged, subjected to acts of God, or on which any serial numbers have been altered, defaced or removed. Seller will not be responsible for any dismantling or reinstallation charges, environmental wear and tear, normal maintenance expenses, or shipping and freight expenses required to return products to ALARM LOCK. Additionally, this warranty shall not cover scratches, abrasions or deterioration due to the use of paints, solvents or other chemicals.

THERE ARE NO WARRANTIES, EXPRESS OR IMPLIED, WHICH EXTEND BEYOND THE DESCRIPTION ON THE FACE HEREOF. THERE IS NO EXPRESS OR IMPLIED WARRANTY OF MERCHANTABILITY OR A WARRANTY OF FITNESS FOR A PARTICULAR PURPOSE. ADDITIONALLY, THIS WARRANTY IS IN LIEU OF ALL OTHER OBLIGATIONS OR LIABILITIES ON THE PART OF ALARM LOCK.

Any action for breach of warranty, including but not limited to any implied warranty of merchantability, must be brought within the six months following the end of the warranty period.

IN NO CASE SHALL ALARM LOCK BE LIABLE TO ANYONE FOR ANY CONSEQUENTIAL OR INCIDENTAL DAMAGES FOR BREACH OF THIS OR ANY OTHER WARRANTY, EXPRESS OR IMPLIED, EVEN IF THE LOSS OR DAMAGE IS CAUSED BY THE SELLER'S OWN NEGLIGENCE OR FAULT.

In case of defect, contact the security professional who installed and maintains your security system. In order to exercise the warranty, the product must be returned by the security professional, shipping costs prepaid and insured to ALARM LOCK. After repair or replacement, ALARM LOCK assumes the cost of returning products under warranty. ALARM LOCK shall have no obligation under this warranty, or otherwise, if the product has been repaired by others, improperly installed, improperly used, abused, altered, damaged, subjected to accident, nuisance, flood, fire or acts of God, or on which any serial numbers have been altered, defaced or removed. ALARM LOCK will not be responsible for any dismantling, reassembly or reinstallation charges, environmental wear and tear, normal maintenance expenses, or shipping and freight expenses required to return products to ALARM LOCK. Additionally, this warranty shall not cover scratches, abrasions or deterioration due to the use of paints, solvents or other chemicals.

This warranty contains the entire warranty. It is the sole warranty and any prior agreements or representations, whether oral or written, are either merged herein or are expressly cancelled. ALARM LOCK neither assumes, nor authorizes any other person purporting to act on its behalf to modify, to change, or to assume for it, any other warranty or liability concerning its products.

In no event shall ALARM LOCK be liable for an amount in excess of ALARM LOCK's original selling price of the product, for any loss or damage, whether direct, indirect, incidental, consequential, or otherwise arising out of any failure of the product. Seller's warranty, as hereinabove set forth, shall not be enlarged, diminished or affected by and no obligation or liability shall arise or grow out of Seller's rendering of technical advice or service in connection with Buyer's order of the goods furnished hereunder.

ALARM LOCK RECOMMENDS THAT THE ENTIRE SYSTEM BE COMPLETELY TESTED WEEKLY.

Warning: Despite frequent testing, and due to, but not limited to, any or all of the following; criminal tampering, electrical or communications disruption, it is possible for the system to fail to perform as expected. ALARM LOCK does not represent that the product/system may not be compromised or circumvented; or that the product or system will prevent any personal injury or property loss by burglary, robbery, fire or otherwise; nor that the product or system will in all cases provide adequate warning or protection. A properly installed and maintained alarm may only reduce risk of burglary, robbery, fire or otherwise but it is not insurance or a guarantee that these events will not occur. CONSEQUENTLY, SELLER SHALL HAVE NO LIABILITY FOR ANY PERSONAL INJURY, PROPERTY DAMAGE, OR OTHER LOSS BASED ON A CLAIM THE PRODUCT FAILED TO GIVE WARNING. Therefore, the installer should in turn advise the consumer to take any and all precautions for his or her safety including, but not limited to, fleeing the premises and calling police or fire department, in order to mitigate the possibilities of harm and/or damage.

ALARM LOCK is not an insurer of either the property or safety of the user's family or employees, and limits its liability for any loss or damage including incidental or consequential damages to ALARM LOCK's original selling price of the product regardless of the cause of such loss or damage.

Some states do not allow limitations on how long an implied warranty lasts or do not allow the exclusion or limitation of incidental or consequential damages, or differentiate in their treatment of limitations of liability for ordinary or gross negligence, so the above limitations or exclusions may not apply to you. This Warranty gives you specific legal rights and you may also have other rights which vary from state to state.