



# CL3500 Series

## Cylindrical Lever Locksets



# Product Catalog

Experience a safer  
and more open world

# Applications

## CL3500 Series

### Table of Contents

Applications.....	2
Features.....	3
Functions.....	4
Trim Designs.....	6
Options & Accessories.....	7
How to Order .....	9
Quick Codes .....	10
How to Specify .....	11

### Applications

A heavy-duty Grade 1 lever lockset, ideal for commercial, institutional and multi-family applications such as:

- Interior offices
- Apartment complexes
- Convalescent and elderly care facilities
- Hotels
- Restaurants
- Retail centers

### Advantages

- Non-handed
- Solid cast levers
- Independent return springs to prevent lever sag
- Through-bolted cylindrical chassis prevents rotation and ensures proper alignment 
- Designed to meet ANSI/BHMA Grade 1
- Trim and keying compatible with other Corbin Russwin locksets



[www.corbinrusswin.com](http://www.corbinrusswin.com)

### Features

#### Handing

Non-handed.

#### Door Thickness

1-3/4" (45mm) standard (fits doors 1-3/8" - 1-3/4" (35mm - 45mm))

#### Backset

2-3/4" (70mm) standard.  
Optional: 2-3/8" (60mm), 3-3/4" (95mm) and 5" (127mm); see Quick Codes pages 10-11.

#### Lock Chassis

Steel, zinc dichromated for corrosion resistance.

#### Front

Brass, Bronze or Stainless Steel. 2-1/4" x 1-1/8" (29mm) standard for 2-3/4" (70mm), 3-3/4" (95mm) and 5" (127mm) backset. 2-1/4" x 1" (57mm x 25mm) standard for 2-3/8" (60mm) backset. Accommodates flat doors and doors beveled 1/8" (3mm) in 2" (51mm).

Optional: rounded corner fronts; 1" (25mm) fronts; see Quick Codes pages 10-11.

#### Latchbolt

Brass, chrome plated with 1/2" (13mm) throw.

#### Auxiliary Latchbolt

Deadlocking latchbolt prevents manipulation when door is closed.

#### Strike

Wrought brass or stainless steel ANSI curved lip, 4-7/8" x 1-1/4" x 1-1/4" (124mm x 32mm x 32mm) lip to center standard. Optional strikes, lip lengths and ANSI wrought strike box available; see Quick Codes pages 10-11.

#### Cylinder

Brass, 6-pin, L4 keyway, 0-bitted standard. Optional Cylinders available; see Quick Codes pages 10-11.

#### Keying Features Available

7-pin  
Master keying  
Construction master keying  
Visual key control  
Concealed key control  
Interchangeable core (IC)  
Security  
Security IC  
Access 3® Patented  
Access 3® Security  
Access 3® High Security  
Access 3® Patented IC  
Access 3® Security IC

Access 3® High Security IC  
Pyramid Security  
Pyramid Security IC  
Pyramid High Security  
Pyramid High Security IC

#### Keys

Two nickel-silver standard.

#### Warranty

Seven-year limited.

#### MicroShield®

CL3500 series locks are available with MicroShield® antimicrobial coating. *MicroShield* is a revolutionary hardware finish coating, using a silver ion based technology, which inhibits the growth of bacteria, algae, yeast, fungus, mold and mildew. *MicroShield* is non-toxic and lasts for the lifetime of the finish to which it is applied. To order, suffix option code "C".

Note: MicroShield® coating may vary finish color from architectural standards. *MicroShield* is not intended as a substitute for traditional infection control programs such as hand hygiene or use of disinfectants. Coated product must still be cleaned to insure the surfaces will be free of destructive microbes. Corbin Russwin makes no representations or warranties, express or implied, as to the efficacy of the *MicroShield* antimicrobial.

#### California State Reference Code

(Formerly Title 19, California State Fire Marshal Standard)

All levers with returns comply; levers return to within 1/2" of door face.

#### UL-cUL

 All locks listed for "A" label and lesser class single doors, 4' x 10'. Letter F and UL symbol on latch front indicate listing.

Any retrofit or other field modification to a fire-rated opening can potentially impact the fire rating of the opening, and Corbin Russwin, Inc. makes no representations or warranties concerning what such impact may be in any specific situation. When retrofitting any portion of an existing fire-rated opening, or specifying and installing a new fire-rated opening, please consult with a code specialist or local code official (Authority Having Jurisdiction) to ensure compliance with all applicable codes and ratings.

### Certification/Compliance

#### ANSI/BHMA

Designed to meet A156.2 Series 4000, Grade 1.  
Meets A117.1 Accessibility Code.

#### Federal

Meets FF-H-106C.

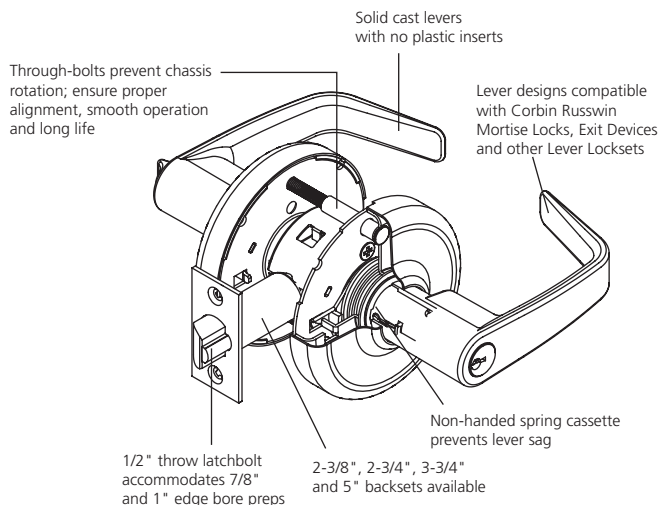

# Functions

## CL3500 Series

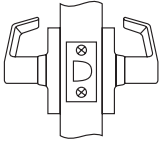
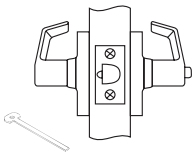
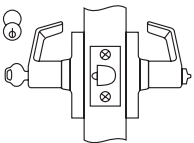
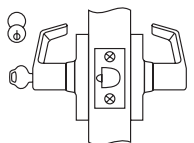
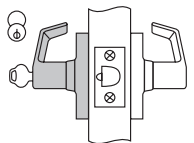
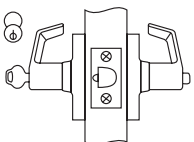
Outside	Inside	Series/ Function	Type	ANSI No.	Function Description
		CL3510	Passage or Closet	F75	<ul style="list-style-type: none"> <li>Latchbolt by lever either side.</li> <li>Both levers always free.</li> </ul>
		CL3520	Privacy Bedroom or Bathroom	F76A	<ul style="list-style-type: none"> <li>Throw-off latchbolt by lever either side.</li> <li>Outside lever locked by push button.</li> <li>Outside lever unlocked by emergency release tool outside, by rotating lever or by closing door.</li> <li>Inside lever always free.</li> </ul>
		CL3551	Entrance or Office	F109	<ul style="list-style-type: none"> <li>Deadlocking latchbolt by lever either side except when turn button locks outside lever. Pushing turn button locks outside lever, requiring use of key outside to unlock.</li> <li>Turning inside lever unlocks outside lever (when button is pushed in but not turned).</li> <li>Pushing in and turning button locks outside lever, requiring key at all times. Turning inside lever does not unlock outside lever until button is manually turned to unlocked position.</li> <li>Inside lever always free.</li> </ul>
		CL3555	Classroom	F84	<ul style="list-style-type: none"> <li>Deadlocking latchbolt by lever either side except when key outside locks outside lever.</li> <li>Outside lever unlocked by key outside.</li> <li>Inside lever always free.</li> </ul>
		CL3557	Storeroom or Closet	F86	<ul style="list-style-type: none"> <li>Deadlocking latchbolt by key in outside lever or by rotating inside lever.</li> <li>Outside lever always rigid.</li> <li>Inside lever always free.</li> </ul>
		CL3561	Entrance or Office	F82A	<ul style="list-style-type: none"> <li>Deadlocking latchbolt by lever either side, except when push button locks outside lever.</li> <li>Push button released by turning inside lever or by key in outside lever.</li> <li>Closing door does not release push button.</li> <li>Inside lever always free.</li> </ul>

 Indicates optional interchangeable core available; see How to Order, page 9.

 Indicates lever always rigid.

# Functions

## CL3500 Series

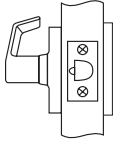
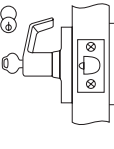
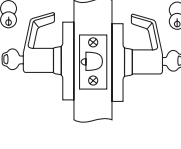
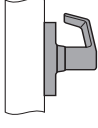
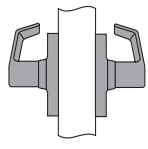
Outside	Inside	Series/ Function	Type	ANSI No.	Function Description
		CL3580	Passage Lever x Blank Plate	F111	<ul style="list-style-type: none"> <li>• Deadlocking latchbolt by lever.</li> <li>• Lever on one side; blank plate on other side.</li> <li>• Lever always free.</li> <li>• For single or double communicating doors.</li> </ul>
		CL3581	Keyed Lever x Blank Plate	F113	<ul style="list-style-type: none"> <li>• Deadlocking latchbolt by lever, except when lever is locked by key.</li> <li>• Lever on one side, blank plate on other side.</li> </ul>
		CL3582	Store Door	F91	<ul style="list-style-type: none"> <li>• Deadlocking latchbolt by lever either side, except when key either side locks both levers.</li> <li>• Keyed alike unless otherwise specified.</li> </ul>
		CL3550	Half Dummy Trim	—	<ul style="list-style-type: none"> <li>• Lever acts as pull only; no operation.</li> </ul>
		CL3570	Full Dummy Trim	—	<ul style="list-style-type: none"> <li>• Levers act as pulls only; no operation.</li> </ul>

 Indicates optional interchangeable core available; see How to Order, page 9.

 Indicates lever always rigid.

# Trim Designs

## CL3500 Series



### Armstrong

**AZD**

**Lever:** Die-cast zinc  
**Rose:** Wrought brass or bronze

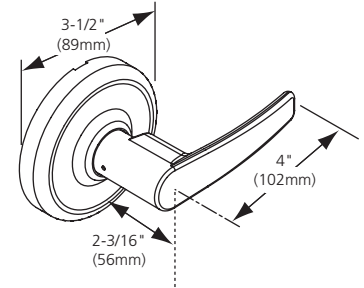

### Newport

Complies with codes requiring lever to return to within 1/2" (13mm) of door face.

**NZD**

**Lever:** Die-cast zinc  
**Rose:** Wrought brass or bronze

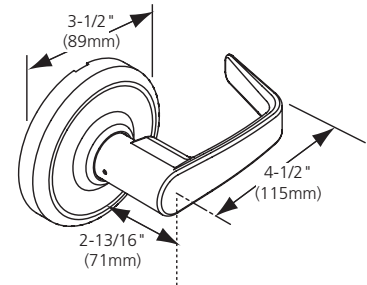

### Princeton

Complies with codes requiring lever to return to within 1/2" (13mm) of door face.

**PZD**

**Lever:** Die-cast zinc  
**Rose:** Wrought brass or bronze

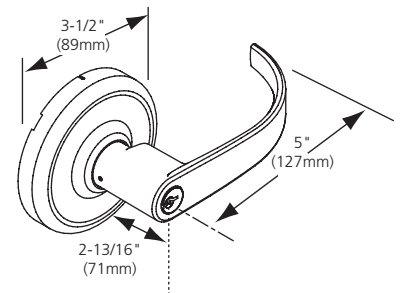

# Options & Accessories

## CL3500 Series

### Latches

To order optional latchbolt with lockset, see How to Order, page 9.

To order latchbolt separately, specify Part No. x Finish (e.g., 599F91 x 626).

Backset and Front Description		Plain	Deadlocking	Throw-Off
2-3/8" Backset	1" width, square corner	599F91	599F92	599F93
	1" width, rounded corner	599F94	599F95	599F96
	1-1/8" width, square corner	599F97	599F98	599F99
	1-1/8" width, rounded corner	600F00	600F01	600F02
2-3/4" Backset	1" width, square corner	600F03	600F04	600F05
	1" width, rounded corner	600F06	600F07	600F08
	1-1/8" width, square corner	600F09	600F10	600F11
3-3/4" Backset	1-1/8" width, rounded corner	600F12	600F13	600F14
	1-1/8" width, square corner	600F62	600F63	600F64
5" Backset	1-1/8" width, rounded corner	600F65	600F66	600F67
	1-1/8" width, square corner	600F68	600F69	600F70
5" Backset	1-1/8" width, rounded corner	600F71	600F72	600F73
	1-1/8" width, square corner			

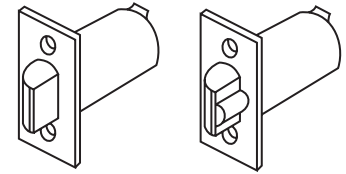

Plain  
(CL3510)

Deadlocking  
(All other functions)

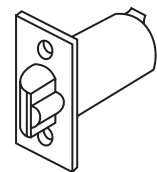

Throw-Off  
(CL3520)

Housing diameter 7/8" for all models. 1" diameter latch sleeve furnished with each latchbolt.

### Strikes

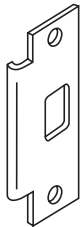

#### ANSI Curved Lip (standard)

Brass or stainless steel.

4-7/8" (124mm) x 1-1/4" (32mm) x 1-1/4" (32mm) lip to center.

Optional lip lengths: 1" (25mm), 1-1/8" (29mm), 1-3/8" (35mm), 1-1/2" (38mm), 1-3/4" (44mm), 2" (51mm), 2-1/4" (57mm), 2-1/2" (64mm), 2-3/4" (70mm), 3" (76mm).

To order separately, specify 217L13 x Lip Length x Finish.

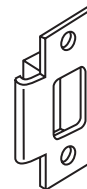

#### Curved Lip "T" Strike

Brass.

2-3/4" (70mm) x 1-1/8" (29mm) x 1-1/4" (32mm) lip to center

Optional lip lengths: 1" (25mm), 1-1/8" (29mm), 1-3/8" (35mm), 1-1/2" (38mm), 1-3/4" (44mm),

2" (51mm), 2-1/4" (57mm), 2-1/2" (64mm), 2-3/4" (70mm), 3" (76mm)

To order optional strike with lockset, see Quick Codes, page 9.

To order separately, specify 586L19 x Lip Length x Finish.

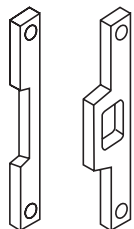

#### Rabbeted Front and Strike

Brass or bronze.

4" (102mm) x 5/8" (16mm) for 1/2" (13mm) rabbet.

No optional lip lengths.

To order with lockset, see How to Order, page 9.

To order separately, specify 601F28 x Finish.

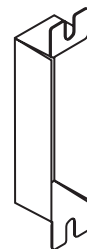

#### Full Lip Strike

Brass.

2-3/4" (70mm) x full lip x 1-1/8" (29mm) lip to center.

No optional lip lengths. To order separately specify 607F76.

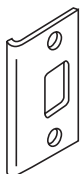

# Options & Accessories

## CL3500 Series

### Cylinders

		Standard Cylinder	Interchangeable Core
		.509" plug diameter conventional .510" plug diameter Access 3® .552" plug diameter security .496" plug diameter Pyramid Brass, 6-pin 2 nickel silver keys Finishes: 606, 626	.509" plug diameter conventional .510" plug diameter Access 3® .552" plug diameter security .496" plug diameter Pyramid Brass, 6-pin 2 nickel silver keys Finishes: 606, 626
Conventional	6-pin	2000-033 (standard)	8000
	7-pin	2000-033-7	8000-7
Security	6-pin	2010-033	8010
Pyramid High Security	7-pin	2020-033	8020
Pyramid Security	7-pin	2027-033	8027
Access 3® - Patented	6-Pin	2500-033	8500
Access 3® - Security	6-Pin	2600-033	8600
Access 3® - High Security	6-Pin	2700-033	8700
Schlage® C Keyway (0-bitted)	6-pin	2400-033-C	—
Schlage® C Keyway (keyed random)	6-pin	2400-033-C-KR	—
Sargent® LA Keyway (0-bitted)	6-pin	2400-033-LA	—

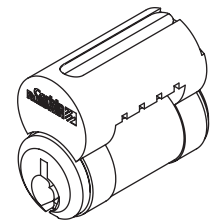
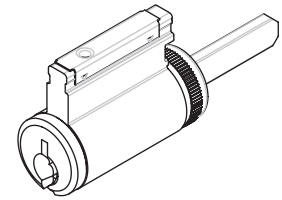

To order optional cylinder with lockset, see How to Order, page 9.  
To order cylinder separately, specify Part No. x Keyway x Finish (e.g., 8000 x L4 x 626).

### Compatibility with Competitive Cylinders

Competitive Cylinder	Parts Required for Installation
Schlage fixed core conventional 21-002, 23-001 or 23-013	682F398 tailpiece included with M06 option.
Schlage fixed core Primus 20-548, 20-550, 20-748 or 20-750	682F398 tailpiece included with M06 option.
Schlage 6-pin LFIC	Specify M69 - 697F942 Tailpiece included with M69 option.
SFIC, 6 or 7-pin	682F958 tailpiece kit and special lever included with M08 option. Accommodates 6 and 7-pin cores.
Sargent fixed core C10-1	682F969 Tailpiece kit and special lever. Included with M09 options. See How to Order, page 9.

For Assa® and Medeco® retrofit cylinders, consult those manufacturers' catalogs.



# How to Order

## CL3500 Series

### Ordering Examples

#### Stock Order

Quantity	Series/Function	Trim	Finish
100	CL3555	NZD	626

#### Split Trim / Finish Order

Quantity	Series/ Function	Trim		Finish	
		Outside	Inside	Outside	Inside
12	CL3555	NZD	AZD	626	625

#### Contract / Detailed Order

Quantity	Keypad	Series/ Function	Trim	Finish	Backset	Optional Strike	Misc. Options	Optional Cylinder	Keying
24	AA1	CL3555	PZD	626	B238	SC200	M04-M17	C6	VKC1

### Where to find ordering information and Quick Codes

Series/Function	Pages 4-5
Trim Designs	Page 6
Finish	Page 10
Door Thickness	Page 10
Backset	Page 10
Strike	Page 10
Miscellaneous Options	Page 11
Cylinder and Keying	Page 10

# Quick Codes

## CL3500 Series

### Cylinder and Keying

Description	Specify
Conventional 6-pin	(standard)
Conventional 7-pin	7P
Less cylinder(s)	LC
IC 6-pin	C6
IC 6-pin with Temporary Construction Core (Red)	CT6R
IC 6-pin with Temporary Construction Core (Blue)	CT6B
IC 6-pin with Temporary Construction Core (Green)	CT6G
IC 6-pin less core	CL6
SFIC 6- or 7-pin Small Format Disposable Core	CTSD
IC 7-pin	C7
IC 7-pin less core	CL7
IC 7-pin with Temporary Construction Core (Red)	CT7R
IC 7-pin with Temporary Construction Core (Blue)	CT7B
IC 7-pin with Temporary Construction Core (Green)	CT7G
Security	HS
Security IC	CHS
Access 3® AP Fixed Core	AP
Access 3® AS Fixed Core	AS
Access 3® AHS Fixed Core	AHS
Access 3® AP IC	ACP
Access 3® AS IC	ACS
Access 3® AHS IC	ACHS
Pyramid High Security Fixed Core	PHS
Pyramid High Security IC	PCHS
Pyramid IC Less Core	CLP
Pyramid with temporary construction core	CTP
Pyramid Security Fixed Core	PS
Pyramid Security IC	PCS
Pyramid Disposable Core	CTPD
6-Pin Disposable Core	CT6D
7-Pin Disposable Core	CT7D
0-bitted with 2 blank keys	(standard)
Keyed alike	KA
Keyed random	KR
Construction master keyed	CMK
Visual key control (VKC)	
No bitting or keyset stamping on keys	VKC0
Keys only	VKC1
Cylinders and keys (not for HS, CHS, PHS or PCHS)	VKC2
Cylinders only (not for HS, CHS, PHS or PCHS)	VKC3
Concealed key control (CKC)	
CKC cylinders with VKC keys	CKC2
CKC cylinders only (not for PHS, PCHS)	CKC3
2 keys per lock	(standard)
More than 2 keys	KY# (e.g., KY6)
Schlage® C keyway cylinder	C
Sargent® LA keyway cylinder	LA

### Finishes

Description	Specify
ANSI/BHMA 605 (US3)	Bright Brass 605
ANSI/BHMA 606 (US4)	Satin Brass 606
ANSI/BHMA 611 (US9)	Bright Bronze 611
ANSI/BHMA 612 (US10)	Satin Bronze 612
ANSI/BHMA 613 (US10B)	Dark Oxidized Satin Bronze, Oil Rubbed 613
613E	Dark Oxidized Satin Bronze - equivalent 613E
613L	Dark Oxidized Satin Bronze, Clear Coated 613L
ANSI/BHMA 618 (US14)	Bright Nickel Plated 618
ANSI/BHMA 619 (US15)	Satin Nickel Plated 619
619C	Satin Nickel Plated with Microshield® 619C
ANSI/BHMA 625 (US26)	Bright Chromium Plated 625
ANSI/BHMA 626 (US26D)	Satin Chromium Plated 626
626C	Satin Chromium Plated with MicroShield® 626C
722	Black Oxidized Bronze, oil rubbed 722
BSP	Black Suede Powder Coat BSP
WSP	White Suede Powder Coat WSP

Zinc levers are plated to match BHMA finish.

### Strikes

ANSI Lip to Center	ANSI Curved Lip Specify	T-Strike Curved Lip Box Specify	Full Lip Specify
1" (25mm)	SA100	SC100	
1-1/8" (29mm)	SA118	SC118	SF118
1-1/4" (32mm)	SA114 (standard)	SC114	
1-3/8" (35mm)	SA138	SC138	
1-1/2" (38mm)	SA112	SC112	
1-3/4" (44mm)	SA134	SC134	
2" (51mm)	SA200	SC200	
2-1/4" (57mm)	SA214	SC214	
2-1/2" (64mm)	SA212	SC212	
2-3/4" (70mm)	SA234	SC234	
3" (76mm)	SA300	SC300	
Rabbeted front and strike		Specify SR118	

### Door Thickness

Door Thickness	Specify
1-3/4" (44mm)	(standard)*
1-3/8" (35mm)	D138**

\*Fits doors 1-3/8" -1-3/4"

\*\*Lock preset to for 1-3/8" door. Supplied with 2-3/8" backset latch unless B234 specified

### Backset

Description	Specify
2-3/8" (60mm)	B238
2-3/4" (70mm)	B234 (standard)
3-3/4" (95mm)	B334
5" (127mm)	B500

# Quick Codes & How to Specify

## CL3500 Series

### Miscellaneous Options

Description	Specify
Spanner head screws	M02
Torx® head screws	M04
Less cylinder, with tailpiece for Schlage® fixed core cylinder (AZD, NZD & PZD designs)	M06
Lever to accept 6 or 7-pin SFIC (AZD, NZD & PZD designs)	M08
Lever to accept Sargent® fixed core cylinder (NZD & PZD designs only)	M09
Lever to accept Schlage® LFIC (NZD & PZD design only)	M69
Rounded corners on latch front	M13
1" latch front, square corners (standard for 2-3/8" backset)	M14
1" latch front, rounded corners	M15
ANSI wrought strike box	M17
Knurling outside and inside	M20
Knurling outside only	M21
Knurling inside only	M22
Abrasive coat outside and inside	M23
Abrasive coat inside only	M24
Abrasive coat outside only	M25
1-1/8" front, square corners (standard for 2-3/4", 3-3/4" and 5" backsets)	M32

### Suggested Specification

All locksets shall be CL3500 Series Heavy-Duty Cylindrical Lever Locksets as manufactured by Corbin Russwin Architectural Hardware.

A single lock chassis shall accommodate 1-3/8" (35mm) to 1-3/4" (44mm) thick doors. Locksets shall be non-handed. Locksets shall have through-bolted anti-rotation rose liners and shall contain no exposed screws. Chassis mounting screws may be accessed only when the lever and rose are removed.

Locksets shall have solid cast levers with no plastic inserts, and wrought roses on both sides. Locksets shall have lever return spring cassettes to prevent lever sag.

Levers shall operate independently. Lever handles shall be a minimum of 4" (102mm) in overall length and shall provide a minimum of 2" clearance from the surface of the door to the inside of the lever at the midpoint, and may also have a return that comes to within 1/2" of the door surface. Levers on keyed locksets shall be removable only when the designated key is in the cylinder.

A single lockset shall accommodate 6 or 7-pin conventional cylinders and all levels of master keying, construction master keying, visual key control, high security and interchangeable core. Cylinders may be easily changed by removing the lever without disassembling the lockset.

All locksets shall be listed by Underwriters Laboratories for A label and lesser class single doors, 4'x10'.

Certification:  
Federal Specification FF-H-106C  
Designed to meet ANSI/BHMA A156.2 Series 4000, Grade 1  
ANSI A117.1 Accessibility Code  
California State Reference Code (formerly Title 19, California State Fire Marshal Standard)

All locks, trim and cylinders shall be from one manufacturer.

All locksets shall carry a seven-year limited warranty.

The ASSA ABLOY Group is the global leader in access solutions. Every day, we help billions of people experience a more open world.

ASSA ABLOY Opening Solutions leads the development within door openings and products for access solutions in homes, businesses and institutions. Our offering includes doors, frames, door and window hardware, locks, perimeter fencing, access control and service.



For additional information, contact your  
ASSA ABLOY Door Security Solutions  
sales consultant or visit [www.corbinruswin.com](http://www.corbinruswin.com).

**In U.S.**

Corbin Russwin  
Architectural Hardware  
225 Episcopal Road  
Berlin, CT 06037  
Phone: 800-543-3658  
Fax: 800-447-6714  
[www.corbinruswin.com](http://www.corbinruswin.com)

**In Canada**

ASSA ABLOY Door  
Security Solutions Canada  
160 Four Valley Drive  
Vaughan, Ontario  
Canada L4K 4T9  
Phone: 800-461-3007  
Fax: 800-461-8989  
[www.assaabloydss.ca](http://www.assaabloydss.ca)



**MicroShield®**

As part of their promise to provide innovative solutions to their customers, certain ASSA ABLOY Group brands offer the MicroShield® technology, registered with the EPA and FDA. MicroShield® is a silver-based antimicrobial coating designed to inhibit the growth of bacteria. MicroShield® is a registered trademark of Yale Security Inc., an ASSA ABLOY Group company.