

C Series Residential Locks

Value Product

The return of the Comet brings with it the exceptional value and quality required to meet the demands of the single and multi-family housing markets, as well as light commercial applications.

Combining a variety of knob and lever designs, convenient installation and the Arrow benchmark for dependability, the C Series is perfect in most any space.



Certification:

The C Series has been designed to meet the requirements of ANSI, A156.2, Series 4000, Grade 2.

Features:

Construction – Tubular chassis

Backset – Universal latch is standard. Adjustable for both 2-3/8" (60mm) or 2-3/4" (70mm).

Latch – Brass front. Supplied standard with 1" x 2-1/4" (25mm x 57mm) square corner, 1" x 2-1/4" radius corner and 1-1/8" x 2-1/4" (29mm x 57mm) square corner latch fronts. Available with drive-in latches.

Strike – 1-5/8" x 2-1/4" (41mm x 57mm) full lip strike standard. Available with 1-1/8" x 2-3/4" (29mm x 70mm) "T" strike, or 1-1/4" x 4-7/8" (32mm x 124mm) ANSI strike.

Door Thickness – Fits 1-3/8" to 1-3/4" (35mm-44mm) doors standard.

Exposed Trim – Knobs are wrought brass. Levers are zinc based and are plated to match finish requirements.

Finishes:

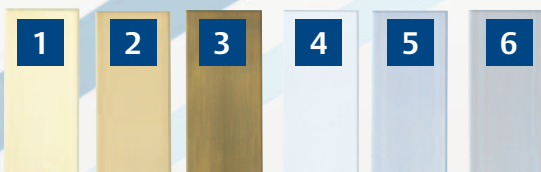

ADA/Americans with Disabilities Act:

Acceptable Door Hardware: Section 4.13.9

Handles, pulls, latches and other operating devices on accessible doors shall have a shape that is easy to grasp with one hand and does not require grasping, tight pinching or twisting of the wrist to operate. Lever operated mechanisms, push-type mechanisms and "U" shaped handles are acceptable designs.

 Look for the universal symbol next to Arrow products that comply with ADA accessibility requirements.

Mounting – Knobsets are supplied with exposed screws on inside rose. Leversets are supplied with concealed screws on inside rose.

Cylinder – Solid brass, 6 pin tumbler, pinned 5. "A" keyway standard. Available in a variety of competitive manufacturers keyways. Supplied with 2 brass keys.

Finishes – US3, US5, US26, US26D, US15.

Packaging – Both knob and leversets are packed 1 per box, 20 per carton.

Warranty – 5 year mechanical, 5 year finish.

	BMHA	U.S. Equiv	Arrow Equiv	Finish
1	605	US3	03	Bright Brass
2	606	US4	04	Satin Brass
3	609	US5	05A	Satin Brass, Blackened
4	625	US26	26	Bright Chromium Plated
5	626	US26D	26D	Satin Chromium Plated
6	619	US15	15	Nickel Plated

C Series Residential Locks

Value Product

CL Series lever designs

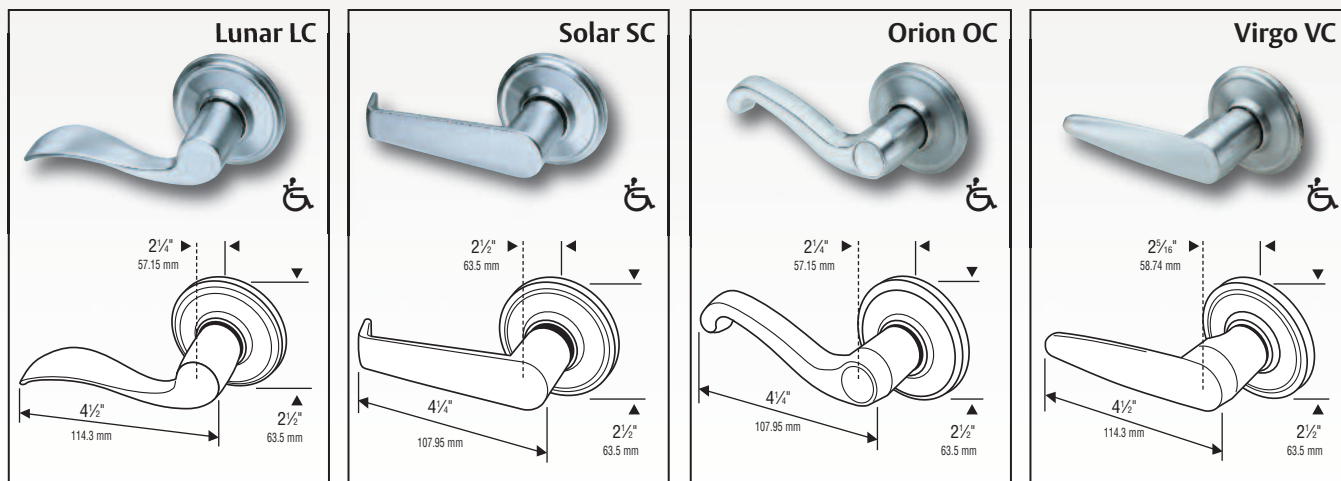

CK Series knob designs

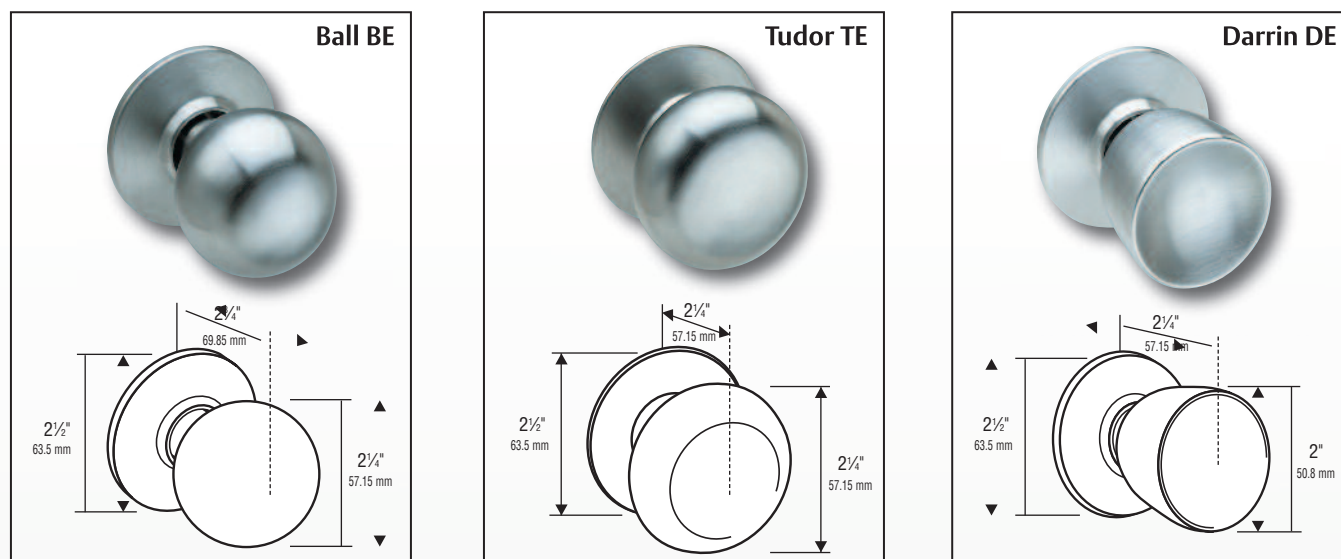

C Series cylinders

Solid brass pin tumbler 6 chambers. Pinned 5 for Grade 2 Locksets. "A" keyway standard. Arrow sectional keyways available. Competitive keyways available. US4, US26D finish.

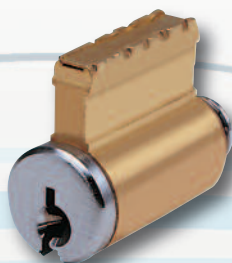

Tailpieces

Part #	Description
10CL-44	Standard Tailpiece (except for BE design)
10CB-44	Standard Tailpiece for BE design

Cylinders

Part #	Description
100YC	Standard Cylinder with tailpiece (except for BE design)
100YC-750	Standard Cylinder with tailpiece for BE design

C Series Residential Locks

Value Product

Latches & Strikes:

Latches

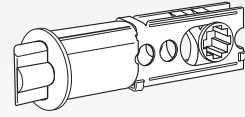
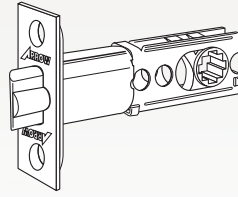
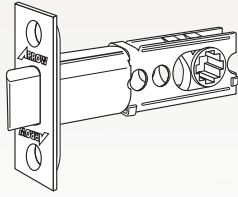

Spring Latch

Dead Latch

Drive-In

2-3/8" - 2-3/4"
Adjustable Backset

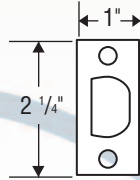

#501 Standard
Optional UL Latch #531

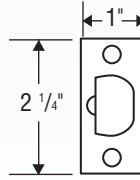

#511 Standard
Optional UL Latch #521



Spring Latch
#505



Dead Latch
#515

Note: Standard latch provided with these three faceplates.

1" x 2-1/4" square corner
1" x 2-1/4" radius corner
1-1/8" x 2-1/4" square corner

Note: Standard latch provided with these three faceplates.

1" x 2-1/4" square corner
1" x 2-1/4" radius corner
1-1/8" x 2-1/4" square corner

Accessories:

Strikes

#502-Standard

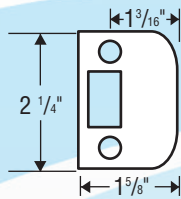

#506-Optional

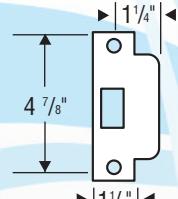

ASA
ANSI 115.2

#500-Optional

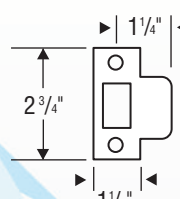

T
ANSI 115.3

#503-Optional

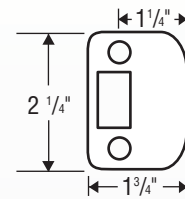



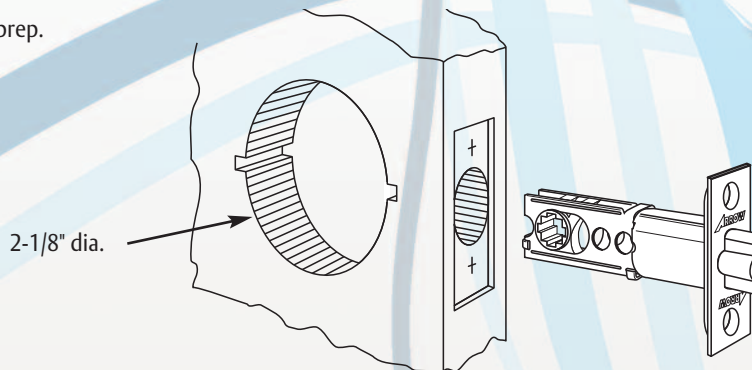

Installation:

Standard 2-1/8" door prep.

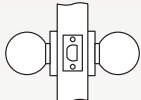
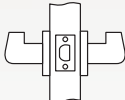
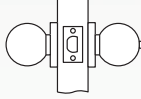
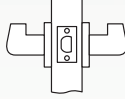
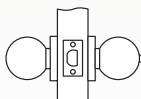
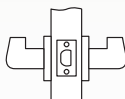
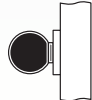

C Series Residential Locks

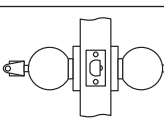
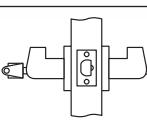
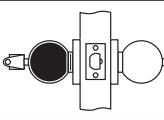
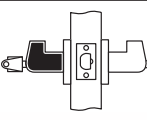
Value Product

ARROW STANDARD	FUNCTION			DESCRIPTION
CK01/CL01	Passage			Latchbolt operated by knob/lever either side.
CK02/CL02	Privacy			Latchbolt operated by knob/lever either side except when inside turnbutton locks outside. Unlocked by rotating button or by using tool outside.
CK04/CL04	Patio			Both knob/levers locked by inside button. Deadlocking latch standard.
CK08/CL08	1/2 Dummy Trim			Rigid trim for one side of door only. Used as pull or to match active trim.
CK11/CL11	Entrance			Latchbolt operated by knob/lever either side except when outside knob/lever is locked by turn-button inside. When outside knob/lever is locked, latchbolt operated by key outside or turning inside knob/lever. Inside button must be manually released.
CK12/CL12	Storeroom			Outside knob/lever always rigid. Latchbolt operated by key in outside knob/lever, or by turning inside knob/lever.
				Indicates knob/lever rigid at all times.

Order Example:

Example: To order a CL Series entry function lockset with a Virgo design lever, satin chrome finish, with a full lip strike and adjustable backset, keyed different:

Specify:

